

Metalworking Tools

for Fabricating and Finishing Professionals



IDEMCO

Portable Saws

Surface Finishing Tools

Surface Preparation Tools

Portable Magnetic Drills

Annular Cutters & Accessories

Drills & Drive Units

Trelawny™ Surface Preparation Equipment and Dust Collection Vacuums

p. 4-21

Hand-Held Scarifiers and Scaling Hammers	p. 6-7
Heavy-Duty Needle/Chisel Scalars, incl. Low-Vibration & ATEX models	p. 8-14
Needles	p. 14
Long-Reach Chisels/Scrapers/Scalars	p. 15
Floor Scarifiers	p. 16-17
Deck Hammers, Deck Descalers	p. 18-19
Dust Collection Vacuums	p. 21



Magnetic Drills, Annular Cutters, Drills & Drive Units and Bevelers

p. 22-80

MABasic Portable Magnetic Drills	p. 28-31
Portable Magnetic Drills up to 2" dia.	p. 32-37
Portable Magnetic Drills from 2-1/16" to 3-1/8" dia.	p. 38-43
Portable Magnetic Drills from 4-1/16" to 5-1/8" dia.	p. 44-49
Pneumatic Portable Magnetic Drill	p. 50
Hydraulic Portable Magnetic Drills	p. 51-52
Annular Cutters (including one-touch and rail cutters)	p. 54-63
Carbide-Tipped Hole Saws	p. 64
Accessories	p. 65-71
Electric Drills and Drive Units	p. 72-73
Special OEM Electric Motor Options	p. 74
Custom-Engineered Drills	p. 75
Pneumatic Drills and Drive Units	p. 76
Corner Drills and Drives	p. 77
SDS Rotary Hammer Drills	p. 78
Pneumatic Woodboring Air Drills	p. 79
Nut Runners	p. 80

Special Tools and Information

SAFEWRENCH® Safe Striking Wrench	p. 19
Tools for Hot Work Zones	p. 20
Underwater Tools	p. 53
ATEX Directive	p. 81



Surface Finishing Tools and Accessories

p. 82-117

PTX Eco Smart Linear Grinding System and Kits	p. 84-86
PTX Abrasives and Accessories	p. 87-91
MULTI-MAX Multipurpose Grinding Station	p. 92-93
VARILEX® Speed-Controlled Surface Finishing/Blending Tool	p. 94-95
Flap Discs	p. 96-104
FIX Hook & Loop System	p. 105-107
Polishing and Maintenance Compounds, Powders and Sprays	p. 107
Mirror Finishing Discs	p. 108
Fleece Discs	p. 108-109
Cleaning Discs	p. 109
PIPE-MAX Pipe Belt Grinder	p. 110
Gladius®1800 Multifunctional Grinder	p. 111
ROLEI® BE 5 Sheet Metal Deburring Machine	p. 112
Portable Beveling Machines	p. 113-117

Saws, Pipe Cutting Machines and Accessories

p. 118-127

Dry Cutting Circular Saws	p. 118-119
Portable Reciprocating Saws & Accessories	p. 120-121
AirPac Pneumatic Tool Line Dryer/Cleaner	p. 121
Hydraulic Power Unit	p. 121
Portable Band Saws & Accessories	p. 122-123
Portable Power Hacksaws	p. 124-125
Pipe Cutting Machine	p. 126-127

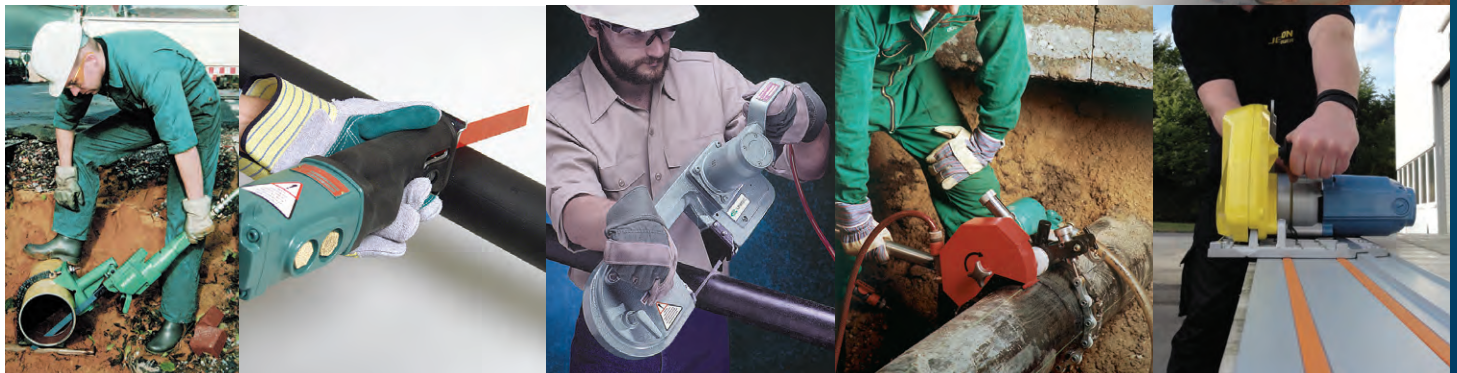

Safety Guidelines

Use all products according to the safety regulations of OSHA and directives by ANSI (American National Safety Institute) B7.1, European DIN EN 13743 and all other applicable international safety standards.

Surface Preparation Tools & Dust Collection Vacuums

CS Unitec's Trelawny™ line of surface preparation tools features many Vibro-Lo™ models. These models include integrated vibration reduction technology to operate with up to 8x less vibration than standard models. Vibration damping components offset the hammer vibration when the tool impacts the workpiece, reducing the risk of vibration-related injury.



Hand-Held Scarifiers – Rotopeen™ (Pneumatic • Electric) p. 4

- Ideal alternative to small-area shot blasting
- Available with 3M's Rotopeen™ 'C' flaps, star cutters and beam cutters



Hand-Held Scaling Hammers (Pneumatic) p. 5

- Single-Head and Triple-Head
- Remove thick scale, heavy corrosion, hard coatings and more



Needle and Chisel Scalers (Pneumatic) p. 6-12

- Remove coatings, corrosion and other accumulated materials
- ATEX-Certified needle scalers for use in Ex Zones and hazardous environments

Long-Reach Chisels / Scrapers / Scalers (Pneumatic) p. 13

- Available lengths ranging from 2' to 6'; chip, scrape and descale with one tool



Floor Scarifiers (Electric • Pneumatic • Gas) p. 14-15

- Available with 8" and 10" cutting widths
- Ideal for the most demanding surface prep & material removal applications

Low-Vibration Steel Deck Hammer (Pneumatic) p. 16

- Fracture and reduce scale, corrosion and thick coatings in minutes, reducing blast media costs



Trident Neptune Flexible Shaft Deck Descalers (Air • Electric) p. 17

- Rapidly remove scale, rust, paint and other unwanted deposits on ship decks and other metal surfaces

Dust Collection Vacuums (Electric • Pneumatic) p. 40

- Electric-powered wet/dry models with HEPA filtration
- Air-powered models are ATEX classified to collect dust/debris and non-flammable liquids. Optional HEPA filtration available.



Surface Preparation Tools for Small and Large Areas

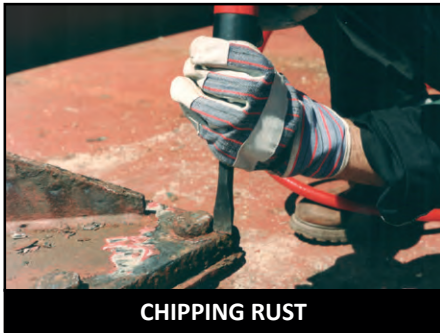

CHIPPING RUST



CLEANING STEEL STRUCTURES



RUST & PAINT REMOVAL



WELD CLEANING



CLEANING STEELWORK



SHIP DECK RUST & RESIDUE REMOVAL



HAZARDOUS PAINT REMOVAL



HEAVY COATING REMOVAL



RUST DESCALING



DUST-FREE COATING REMOVAL



IDEAL FOR DECK MAINTENANCE



COATING & CORROSION REMOVAL



REMOVAL OF ANTI SKID COATINGS



RAPID DESCALING



HOLD TANK CLEANING

Hand-Held Scarifiers - Rotopeen™ Air • Electric

Peening Preparation Tool (PPT) – ideal alternative to small-area shot blasting

CS Unitec's Genuine Trelawny™ Rotopeen™ hand-held scarifiers are the ideal alternative to small-area shot blasting for cleaning and preparing steel and concrete surfaces. They utilize 3M's brand of Rotopeen™ 'C' flaps to offer a captive shot method of surface preparation.

- Integrated dust shroud for dust and debris collection, as well as cleaner, safer removal of lead-based paints and contaminated particles



Air Models
194.0405 and
194.C405,
4" cutting width

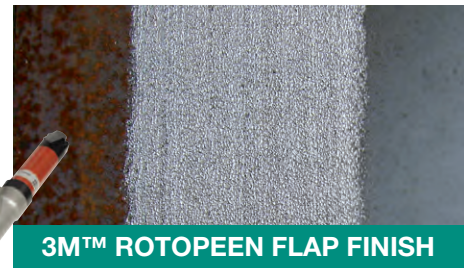

3M™ ROTOPEEN FLAP FINISH



Above: Ergonomic rubber hand grip standard on all new 2" and 4" models. Provides grip for easier pushing along material.

Applications include:

- Aggressive removal of alkyds, adhesives, lead-based paints, mastics, coatings, corrosion & more
- Cleaning & preparing steel and concrete surfaces



Optional Accessory

Above: Optional top handle attachment kit to replace rubber grip on 2" and 4" models. (P/N 312.Q450)

See page 21 for dust extraction systems.

Hand-Held Scarifier Accessories

Star Cutter

P/N 312.S200

Aggressive removal of thick coatings

Beam Cutter

P/N 312.R200

Removal of hard coatings, less aggressive than star cutter

3M™ Rotopeen™ 'C' Flap

P/N 312.MRPC

Removal of paint and rust to bare metal finish

HEAVY SCALING

SURFACE PROFILING

Nuclear	—	—	Radioactive waste removal/capture
Ships decks	Non-slip coatings	—	General paint removal
Construction	Plaster removal	Ceiling / wall paint removal	Ceiling / wall paint removal
Factory Floors	—	Floor marking removal	Floor marking removal
Swimming Pools	Adhesive removal	Adhesive removal	—
Bridge Maintenance	Sealant removal	—	Paint / sealant removal
Pipeline Maintenance	—	—	Protective coating removal



Star Cutter

Cutting Width	Quantity Required
2"	80
4"	160



Beam Cutter

Cutting Width	Quantity Required
2"	56
4"	112



Rotopeen™ 'C' Flap

Cutting Width	Quantity Required
2"	6
4"	12

Pneumatic Hand-Held Scarifiers

Model Number	CFM @ 90 PSI	Speed (RPM)	Cutting Width	Cutting Media	Weight (lbs.)	Vibration Levels m/s ²
194.0205	30	2700	2"	'C' Flaps	7.5	3.5
194.C205	30	2700	2"	Star Cutters	11.5	6.0
194.0405	30	2700	4"	'C' Flaps	9	3.1
194.C405	30	2700	4"	Star Cutters	13.25	4.6

These models are compatible with Star Cutters, Beam Cutters and Rotopeen™ 'C' Flaps



Electric Hand-Held Scarifiers

Model Number	Motor Power	Speed (RPM)	Cutting Width	Cutting Media	Weight (lbs.)	Vibration Levels m/s ²
195.1217	110V	2000	2"	'C' Flaps	11	3.6
195.1220	220V	2000	2"	'C' Flaps	11	3.6



Electric Model 195.1220 2" cutting width with Rotopeen™ 'C' flaps. 4" width also available.



Pneumatic Hand-Held Scaling Hammers



Remove thick scale, heavy corrosion and hard coatings

CS Unitec's Trelawny™ line of pneumatic hand-held scaling hammers are ideal tools for the removal of thick scale, heavy corrosion and hard coatings. Areas of application include pipes, ship decks, oil platforms, storage tanks and bridge structures.

- Single-head scaling hammer includes Vibro-Lo™ vibration reduction technology
- Optional spark-resistant copper beryllium replacement heads reduce risk of explosion in potentially hazardous areas
- Detachable taper fit cutter head reduces cost of replacement and extends piston life



Applications Include:

- Pipes • Ship Decks • Oil Platforms
- Storage Tanks • Bridge Structures
- Gas / Utility Contractors



Pneumatic Hand-Held Scaling Hammers

- Air consumption @ 90 PSI – Single Head: 7 CFM; Triple Head: 11 CFM
- Noise level – 88.1 dB(A) to 92.7 dB(A)

Description	Model Number	Handle Type	Dimensions (LxH)	Vibration Levels (m/s ²)	Weight (lbs.)	Replacement Head Part No.
SF1 Single Head – 3000 Blows per minute						
TCT Cruciform Head	151.5100	Long	19" x 6"	6.8	5	426.5351
TCT Bush Head	151.5105	Long	19" x 6"	6.8	5	426.5352
TCT Cruciform Head	199.5150	Short	9.25" x 6"	6.8	4.5	426.5351
CuBe Cruciform Head	151.5110	Long	19" x 6"	6.8	5	606.5303
VLSF1 Low-Vibration Single Head – 3000 Blows per minute						
TCT Cruciform Head	196.5095	Long	19" x 5.5"	3.7	5	426.5351
CuBe Cruciform Head	196.5110	Long	19" x 5.5"	3.7	5	426.5352
SF3 Triple Head – 9000 Blows per minute						
TCT Cruciform Head	153.5300	Long	19" x 6"	13.4	8	426.5351
TCT Bush Head	153.5305	Long	19" x 6"	13.4	8	426.5352
TCT Cruciform Head	199.5350	Short	9.25 x 6"	13.4	7	426.5351
CuBe Cruciform Head	153.5310	Long	19" x 6"	13.4	8	606.5303



CS Unitec's Trelawny™ Single-Head Hand-Held scaler operates with 8x less vibration than standard models. This tool utilizes vibration damping components to offset the hammer vibration created when the head impacts the workpiece.

Service kits available. Visit our website for more information.

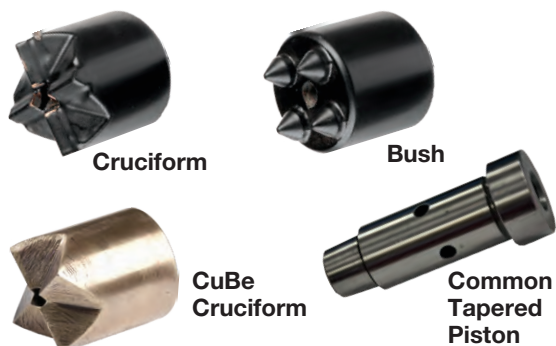

Hand-Held Scaling Hammer Accessories

	Part No.
TCT Cruciform Cutter Head	426.5351
Copper Beryllium (CuBe) Cruciform Cutter Head	606.5303
TCT Bush Cutter Head	426.5352
Common Tapered Piston	612.5301
Single-Piece Steel Piston with Cruciform Head	612.5305



Heavy-Duty Needle Scalers

Heavy-Duty Needle Scalers

Ideal for cleaning and stress-relieving weld seams and joints; texturing concrete; removing coatings, corrosion and other accumulated materials.

Power & Productivity

- Oversized piston with longer stroke
- Heavy-duty hardened anvil
- Chisel-tipped needles

Low Maintenance & Less Downtime

- Air-powered – fewer moving parts
- Converts to chisel scaler in seconds
- Piston valve

Versatile

- One tool for different applications
- Lightweight – easy to handle



1B

Inline Grip



2B



2BPG

Pistol Grip



3BPG

2B Combination Kit

See next page for more information.



Grip	Description	Model Number	Needle Qty./Dia.	Weight (lbs.)	Blows per minute	CFM @ 90 PSI	Noise Level dB(A)	Vibration Levels m/s ²
Inline	1B Needle Scaler	111.1099	12 / 3mm	3.5	3800	3.0	110.4	8.5
	2B Needle Scaler	121.2099	19 / 3mm	5.75	3000	5.5	113.3	9.3
Pistol	2BPG Needle Scaler	123.2199	19 / 3mm	5.75	3000	5.5	113.3	12.6
	3BPG Needle Scaler	133.3199	28 / 3mm	8.25	2200	8.0	114.5	18.9

Service kits available. Visit our website for more information.



Dust Collection Shroud for Standard Needle Scalers

Optional Dust Shroud for Needle Scalers – for use with dust extraction vacuums.
 Model 2B and 2BPG Needle Scalers – Order Dust Shroud P/N 418.2200
 Model 3BPG Needle Scaler – Order Dust Shroud P/N 418.3040



Needle options – see page 14 for the following types of needles:

Chisel	Flat	Pointed	Copper Beryllium	Stainless Steel
light surface marking	light treatment and polishing effect	very hard scale	use in potentially explosive areas ⚠	use in applications where corrosion or humidity is a problem, such as the food processing industry

TVS™ Needle Scalers with Integrated Vacuum Shroud



CS Unitec's Trelawny™ TVS™ Needle Scalers with Integrated Vacuum Shroud enable dust-free working in hazardous applications when used with a dust extraction vacuum (see page 21 for dust collection systems).



Grip	Description	Model Number	Weight (lbs.)	Blows per minute	CFM @ 90 PSI	Noise Level dB(A)	Vibration Levels m/s ²
Inline	2B Needle Scaler	139.2007	6.4	3000	5.5	98.6	17.4
Pistol	2BPG Needle Scaler	139.2107	6.6	3000	5.5	98.6	22.4
	3BPG Needle Scaler	139.3107	9.9	2200	8.0	105.1	19.9

Service kits available. Visit our website for more information.

Heavy-Duty Chisel Scalars

Ideal for splitting, chipping, pointing, brick raking and removing accumulated materials and corrosion.

- Inline, pistol and semi-pistol grip
- Ball bearing chisel retainer

Inline Grip



1B



2B

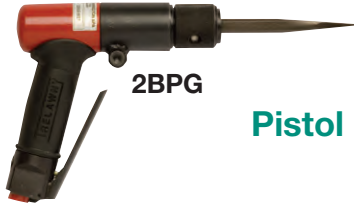

2BPG

Pistol Grip



3BPG



Grip	Description	Model Number	Weight (lbs.)	Blows per minute	CFM @ 90 PSI	Noise Level dB(A)	Vibration Levels m/s ²
Inline	1B Chisel Scaler	114.1200	3.3	3800	3.0	98.9	8.2
	2B Chisel Scaler	124.2200	4.4	3000	5.5	98.6	17.4
Pistol	2BPG Chisel Scaler	125.2300	4.5	3000	5.5	98.6	22.4
	3BPG Chisel Scaler	135.3300	6.2	2200	8.0	105.1	25.6
	3BPG Chisel Scaler*	135.3395	6.2	2200	8.0	105.1	25.6



* 3BPG Chisel Scaler 135.3395 has 5/8" hexagonal chisel holder and is compatible with chisels shown on page 15. All others Chisel Scalars shown above have 1/2" square connection. Service kits available. Visit our website for more information.



2B & 2BPG Combination Kits

Inline Kit includes 2B Needle Scaler, 19 (3mm) needles, 3/4" width chisel and allen wrench. P/N 199.3120 (shown)

Pistol Grip Kit includes 2BPG Needle Scaler, 19 (3mm) needles, 3/4" width chisel and allen wrench. P/N 199.3121



Chisels for Standard Chisel Scalars

1/2" Square Connection

Chisel Part No.	Shank	Length	Width	Application
704.1110	Square	7"	2"	Spark-resistant Aluminum Bronze  for use in hazardous areas
704.2105	Square Cranked End	7"	3/8"	Weld flux and thick coating removal
704.1101	Square	7"	3/4"	Weld splatter removal
704.1103	Square	7"	2-1/2"	Wide flat chisel for the removal of rust or peeling paint
704.1107	Square	10"	3/4"	Flat chisel for weld splatter and sand cast cleaning
704.1106	Square	8"	1/4"	Mortar removal for repointing brick work
704.1112	Square	7"	Moil Point	Concrete chipping

CS Unitec offers a full line of non-sparking, non-magnetic chisels and safety hand tools for hazardous areas and Ex zones. Contact us for details.

Standard Needle Scalars and Chisel Scalars convert in seconds with optional head or when purchased as a Kit. Contact us for more information.

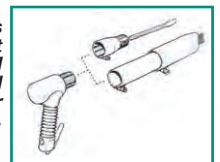

Low-Vibration Needle/Chisel Scalars



High power with low vibration – 8x less than standard models

CS Unitec's Trelawny™ line of Low-Vibration needle/chisel scalars offer high performance and low vibration for greater productivity and improved operator comfort. Ergonomically designed with low maintenance and quick change tooling option.

- Integrated Vibro-Lo™ vibration reduction technology
- Lightweight, easy to handle
- Optional dust shroud for dust and debris collection
- Tool-free needle changeover
- Converts to chisel scaler in seconds



CS Unitec's Trelawny™ Vibro-Lo™ line of Needle/Chisel Scalars operate with 8x less vibration than standard models. These tools utilize vibration damping components to offset the hammer vibration created when the needles/chisels impact the workpiece.



Dust Collection Shroud



VL223



VL203



VL303



ATEX-Certified Needle Scalars available for hazardous environments and Ex Zones. See page 13 for details.

Needle Scalars and Chisel Scalars convert in seconds with optional head or when purchased as a Kit. See page 12 for Kit information.

Applications include:

- Cleaning and stress-relieving weld seams and joints
- Removing coatings, corrosion and other accumulated materials
- Texturing concrete
- Splitting, chipping, pointing and brick raking



Heavy-Duty Low-Vibration Needle Scalers



Heavy-Duty Vibro-Lo™ Needle Scalers

- Inline or pistol grip
- Remove coatings, corrosion and other accumulated materials
- Ideal for stress-relieving weld seams and joints



Needle Scalers and Chisel Scalers convert in seconds with optional head or when purchased as a Kit. See page 12 for Kit information.

Grip	Description	Model Number	Needle Qty./Dia.	Weight (lbs.)	Blows per minute	CFM @ 90 PSI	Noise Level dB(A)	Vibration Levels m/s ²
Inline	VL223 Needle Scaler	199.2103	19 /3mm	5.25	2400	4.0	90.7	2.56
	VL223 Needle Scaler with dust shroud	199.2313	19 /3mm	5.25	2400	4.0	90.7	2.56
Pistol	VL203 Needle Scaler	199.2003	19 /3mm	6	2400	4.0	90.7	2.75
	VL203 Needle Scaler with Dust Shroud	199.2303	19 /3mm	6	2400	4.0	90.7	2.75
	VL303 Needle Scaler	199.3003	28 /3mm	7.75	3000	5.5	109.5	2.30
	VL303 Needle Scaler with Dust Shroud	199.3005	28 /3mm	7.75	3000	5.5	109.5	2.30

Service kits available. Visit our website for more information.

Needle options – see page 14 for the following types of needles:

Chisel	Flat	Pointed	Copper Beryllium	Stainless Steel
light surface marking	light treatment and polishing effect	very hard scale	use in potentially explosive areas ⚠	use in applications where corrosion or humidity is a problem, such as the food processing industry

Dust Collection Shroud for Vibro-Lo™ Needle Scalers



Optional Dust Shroud for Needle Scalers – for use with dust extraction vacuums.

Model VL223 Needle Scaler – Order Dust Shroud P/N 418.2003

Model VL203 Needle Scaler – Order Dust Shroud P/N 418.2003

Model VL303 Needle Scaler – Order Dust Shroud P/N 418.3003



See page 21 for dust extraction systems.

Drop Protection Kit

CS Unitec offers a drop protection kit for our Vibro-Lo™ Needle/ Chisel Scalers. Protect your investment when working at heights or in applications where dropping/ losing the tool is likely, including: offshore platforms and rigs, bridges/ scaffolding, vessels and ships.

For VL223 and VL203
Order P/N 720.2003*

For VL303
Order P/N 720.3003*

* Safety clip and line not supplied



Heavy-Duty Low-Vibration Chisel Scalers

Equipped with Vibro-Lo™ low vibration technology for 8x less vibration than standard models



Grip	Description	Model Number	Weight (lbs.)	Blows per minute	CFM @ 90 PSI	Noise Level dB(A)	Vibration Levels m/s ²
Inline	VL223 Chisel Scaler	199.2213	6.5	2400	4	76.3	3.69
Pistol	VL203 Chisel Scaler	199.2203	7	2400	4	76.3	3.33
	VL303 Chisel Scaler	199.3203	9.5	3000	5.5	78.2	3.7



Service kits available. Visit our website for more information.

Chisels for Vibro-Lo™ Chisel Scalers



Chisel Part Number	Shank	Length	Width	Application
704.3110	Square	7"	2"	Spark resistant Aluminum Bronze for use in hazardous areas
704.3205	Square Cranked End	7"	1-3/8"	Weld flux and thick coating removal
704.3101	Square	7"	3/4"	Weld splatter removal
704.3103	Square	7"	2-1/2"	Wide flat chisel for the removal of rust or peeling paint
704.3107	Square	10"	3/4"	Flat chisel for weld splatter and sand cast cleaning

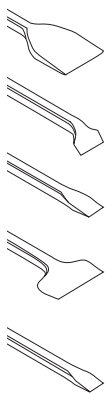

CS Unitec offers a full line of non-sparking, non-magnetic chisels and safety hand tools for hazardous areas and Ex zones. Contact us for details.



Vibro-Lo™ Needle/ Chisel Scaler Kits

CS Unitec offers Vibro-Lo™ Needle/Chisel Scaler Kits, each supplied with the Needle Scaler, 3mm needles, a chisel holder, anvil and a 3/4" blade chisel.

- VL223 Kit** – Order P/N 199.2113
- VL203 Kit** – Order P/N 199.2105
- VL303 Kit** – Order P/N 199.3103

VL223 Kit and VL303 Kit do not include a plastic carrying case.



VL203 Kit – Plastic carrying case included.

ATEX-Certified Needle Scaler Kits



Specially-designed for use in hazardous environments – equipped with Vibro-Lo™ low vibration technology

These specially engineered Trelawny VL203Ex, VL223Ex and VL303Ex needle scalers are:

- Fully certified to the classification: EX II 2Gc IIA T4 under the European Directive 94/9/EC
- Ideal for use in oil, gas & petrochemical industries such as refineries, offshore platforms, LPG terminals and all chemical processing environments.

ATEX Certified

For use in hazardous environments and ATEX and Ex Zones



VL223Ex



VL203Ex



VL303Ex

Grip	Description	Model Number	Needle Qty./Dia.	Weight (lbs.)	Blows per minute	CFM @ 90 PSI	Noise Level dB(A)	Vibration Levels m/s ²
Inline	VL223Ex Needle Scaler with dust shroud	139.2423	19 / 3mm	5.25	2400	4.0	90.7	2.56
Pistol	VL203Ex Needle Scaler with dust shroud	139.2403	19 / 3mm	6	2400	4.0	90.7	2.75
	VL303Ex Needle Scaler with dust shroud	139.2433	28 / 3mm	7.75	3000	5.0	109.5	2.3

Service kits available. Visit our website for more information.

Standard Features

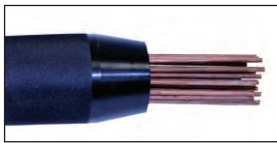

Copper Beryllium needles – high strength with non-sparking and non-magnetic properties



Kit includes ATEX-Certified needle scaler, extra set of Copper Beryllium needles, dust shroud, corner cuff, edge cuff, flat cuff and fall arrestor.



Dust shroud to protect user from hazardous dust and debris

Optional Accessory

Anti-static lanyard available for use with the fall arrestor (P/N 415.3003)



Fall arrestor eliminates the risk of dropping the tool causing injury or equipment damage



Vibro-Lo™ technology operates with 8x less vibration than standard models.

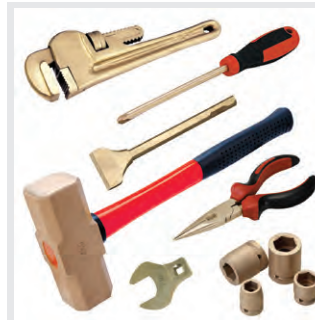

Non-Sparking, Non-Magnetic Safety Hand Tools

CS Unitec offers a complete line of high-quality safety hand tools for use in Ex Zones, ATEX Zones and hazardous environments where hazardous, flammable or combustible vapors, liquids, dusts or residues may be present. **Contact us for more information!**

Needles

CS Unitec's Trelawny™ needles last 10x longer than standard needles. Save time and money with fewer needle changes and less downtime.

All of CS Unitec's Needle Scalers are delivered from stock complete with 180mm long x 3mm diameter chisel tipped high performance needles. Other needle holders are available as accessories for use with 2mm and 4mm diameter needles. We also offer spark resistant needles for use in potentially hazardous areas and Ex zones, as well as stainless steel needles for use in humid areas – such as applications in the food processing industry – where corrosion is a concern.

Standard pack set is one carton of 6 sets. Some models are packed as an individual set in a box. Boxes of 100 qty. needles in a durable, reusable plastic container are available, as well as larger quantities.

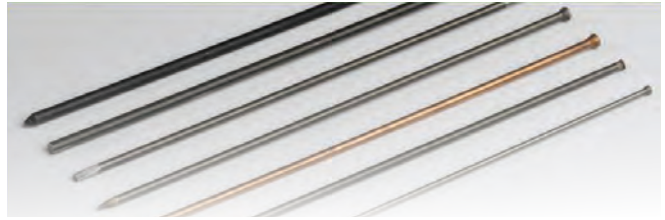

See page 21 for dust extraction systems.

Conversions:
 2mm = 0.08"
 3mm = 0.12"
 4mm = 0.16"
 180mm = 7"

Chisel Tip

These needles will clean the same materials as a pointed tip, but will leave light surface marking



Size	Description	Part #
3mm	6x sets of 12 needles	413.2112
3mm	6x sets of 19 needles	413.2119
3mm	6x sets of 28 needles	413.2128
3mm	Box of 100 needles	453.2110
3mm	Box of 1000 needles	443.2107

Pointed Tip

Sharpened to a conical point, these are the most effective in breaking through very hard scale on materials where some surface indentation is permissible – or where a roughening or keying of the surface is actually desirable.



Size	Description	Part #
3mm	6x sets of 19 needles	413.3119
3mm	6x sets of 28 needles	413.3128
3mm	6x sets of 49 needles	413.3149
3mm	Box of 100 needles	453.3110
3mm	Box of 1000 needles	443.3107
4mm	6x sets of 19 needles	414.3119
4mm	6x sets of 35 needles	414.3135
4mm	Box of 50 needles	454.3105
4mm	Box of 500 needles	444.3107

Flat Tip

Flat-tipped needles will reduce marking on metal surfaces and can give a polishing effect. For use on thin gauge metals and any surface where a light treatment is required.



2mm needles used on a welded joint produce a similar effect to shot peening, reducing stress in the weld.

Size	Description	Part #
2mm	6x sets of 29 needles	412.1129
2mm	6x sets of 51 needles	412.1151
2mm	6x sets of 65 needles	412.1165
2mm	Box of 100 needles	452.1110
2mm	Box of 2000 needles	442.1107
3mm	6x sets of 19 needles	413.1119
3mm	6x sets of 28 needles	413.1128
3mm	Box of 100 needles	453.1110
3mm	Box of 1000 needles (180mm long)	443.1107
4mm	6x sets of 19 needles	414.1119
4mm	6x sets of 35 needles	414.1135
4mm	Box of 50 needles	454.1105
4mm	Box of 500 needles	444.1107
3mm	Box of 1000 needles 5" long (127mm)	443.1105
3mm	19 needles, 5" long (127mm)	443.1115

Spark-Resistant Copper Beryllium

Available in 3mm flat tip only; for use in potentially hazardous areas.

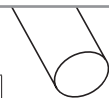

Size	Description	Part #
3mm	6x sets of 12 needles	403.1312
3mm	6x sets of 19 needles	403.1319
3mm	6x sets of 28 needles	403.1328
3mm	Box of 49 needles	403.1349
3mm	Box of 100 needles	453.1310
3mm	Box of 500 needles	443.1307

Stainless Steel

Available in 3mm flat tip only, to be used in applications such as refurbishment of food processing machinery or areas of high humidity where the corrosive effect on needles would be prohibitive. Used on decorative concrete surfaces where contamination of the surface from carbon steel needles is undesirable.



Size	Description	Part #
3mm	Box of 100 needles	453.1207
3mm	Box of 500 needles	443.1207

Long-Reach Chisels/Scrapers/Scalers

Chip, scrape and descale with one versatile tool

CS Unitec's Trelawny™ Long-Reach Scrapers feature one tool with multiple applications.

- Available in 2', 4', 5' and 6' lengths
- 3 tools in 1 – chipper, scraper and descaler
- Quick-change chisel release
- Low air consumption
- Standard and "LITE" models

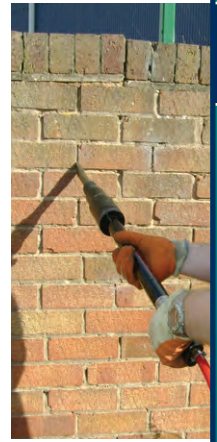

Applications include removal of:

- Ice
- Residue
- Adhesive
- Asbestos
- Linoleum
- Carpeting
- Plaster
- Mortar
- Floor tiles
- Metal slag
- Rubber coatings
- Roofing materials
- Chemical spillages
- Bituminous products



3 tools in 1:

Chipping Scraping Descaling

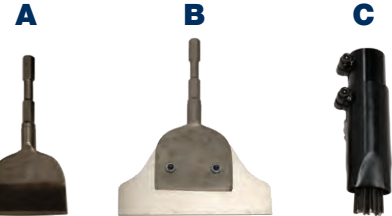

Accessories sold separately.

Long-Reach Chisels/Scrapers

Model	Description	Model Number	Weight (lbs.)	Blows per minute	CFM @ 90 PSI	Noise Level dB(A)
Standard Scrapers	2ft. Chisel	136.3299	8	2200	4.5	84
	2ft. Needle	137.3400	11	2200	4.5	104
	4ft. Chisel	136.3499	11	2200	4.5	84
	5ft. Chisel	136.3599	12	2200	4.5	86
LITE Scrapers	4ft. Chisel	136.3497	6.75	2200	4.5	89
	5ft. Chisel	136.3597	7.5	2200	4.5	89
	6ft. Chisel	136.3697	8.5	2200	4.5	84

A: Chisel Accessories - 5/8" hex

Chisel Part No.	Chisel Length	Blade Width	Applications
705.1100	9"	2"	Spark-resistant aluminum bronze for use in hazardous areas
705.1101	9"	1"	Flat chisel for sand cast chipping
705.1102	8"	4"	Asphalt cutter/paint removal/ general chipping applications
705.1106	9"	2"	Removal of linoleum from floor base
705.1112	8"	4"	Spark-resistant aluminum bronze for use in hazardous areas
705.2102	8"	4"	Floor tile removal
708.1101	1"	1-1/8" comb insert	Brick cleaning and reclamation (use with 8" long comb holder 708.1100)



B: Scraper Accessories

(Assembly includes holder and 1 blade)

Assembly Part No.	Blade Pack	Blade Width	Applications
Flat			
431.3504	439.3504 (5 Blades)	4"	Adhesive and paint build up removal
431.3508	439.3508 (5 Blades)	8"	Paint and coating spillage removal
431.3512	439.3512 (4 Blades)	12"	Carpet and tile removal
Beveled			
431.3904	439.3524 (5 Blades)	4"	Stubborn adhesive removal
431.3908	439.3528 (5 Blades)	8"	Carpet and tile removal
431.3912	439.3522 (4 Blades)	12"	Adhesive removal

C: Needle Scaler Accessories

All long-reach scrapers are available as needle scalers by changing the scraper/chisel with the needle attachment P/N 415.3532. See page 14 for needles.



Floor Scarifiers Gas • Electric • Pneumatic

Remove rust, scale, paint, adhesives and more from steel and concrete

CS Unitec's Trelawny™ Floor Scarifiers tackle the most demanding surface preparation and material removal applications. Ideal for the removal of coatings and corrosion from steel and concrete surfaces to prepare for re-coating. Produce an ideal keyed or grooved profile on concrete for waterproofing and non-slip surface applications.

- Depth control maximizes performance and extends cutter life
- Integrated vacuum connection and hold-to-run handle
- Fully adjustable handlebar for operator comfort
- Electric, pneumatic or gas power



Applications include:

- Removal of rust, scale, paint, adhesives and more
- Keyed or grooved profiles
- Roughing concrete



TFP 200 Cutters

	Individual Cutter	Cutters/Spacers Required Per Drum	Drum Assembly
Wire Brushes	N/A	N/A	320.9620
Beam Cutters*	320.5120	226 Pieces	320.1020SB
Star Cutters*	320.3658	208 Pieces	320.1020SS
TCT Cutters and Spacers*	320.5500 320.4140	80 Pieces 88 Pieces	320.1020ST
Milling Cutters (22mm)*	320.5600	24 Pieces	320.1020SM
TCT Cutters (for grooving) and Spacers*	320.5500 320.4140	24 Pieces 232 Pieces	320.002G

* Beam, Star and TCT Cutters are compatible with other manufacturers' models.

Cutter Applications:

Wire Brushes are ideal for finish cleaning and polishing on steel; can be used for light concrete deposit.

Beam Cutters are ideal for light paint/corrosion removal, with minimal damage to substrate.

Star Cutters are ideal for the removal of mastics and rubberized coatings.

Tungsten Carbide-Tipped (TCT) Cutters are ideal for aggressive applications such as roughing concrete and heavy corrosion removal, as well as grooving roadways for non-slip surface.

Milling Cutters are ideal for the removal of plastic road markings without penetrating the surface.



TFP 200 Floor Scarifiers

Every TFP 200 machine includes mounted drum and cutters

Model Number	Motor Specifications	Max Cutting Depth per Pass	Cutting Width	Dimensions (WxLxH)	Weight (lbs.)
TFP 200 Electric					
320.2004T	230V, 50/60 Hz, 1 Phase, 3 HP	1/8"	8"	14" x 35" x 35"	149
TFP 200 Pneumatic					
320.2012T	165CFM @ 90 PSI, 3.5 HP	1/8"	8"	14" x 35" x 35"	99
TFP 200 Gas					
320.2000T	Honda GX160 Gas, 5.5 HP	1/8"	8"	14" x 35" x 35"	130



Floor Scarifiers Gas • Electric

TFP 260 floor scarifier with 10" cutting width for medium to large jobs

Remove coatings and corrosion from steel and concrete surfaces to prepare for re-coating. Level and remove hard materials. Remove painted lines.

- Depth control maximizes performance and extends cutter life
- Integrated vacuum connection for dust-free operation
- Quick-lift drum lever for operator control
- Gas or electric power



TFP 260 Cutters

	Individual Cutter	Cutters/Spacers Required Per Drum	Drum Assembly
Beam Cutters	326.5120	332 Pieces	326.1016DB
Star Cutters	326.3658	342 Pieces	326.1016DS
TCT Cutters and Spacers	320.7009 320.4160	123 Pieces 129 Pieces	326.1016ST
Milling Cutters (16mm)	320.5680	60 Pieces	326.1016DM
TCT Cutters (for grooving) and Spacers	320.7009 320.4160	36 Pieces 224 Pieces	326.1016GT



TFP 260 Floor Scarifiers

Every TFP 260 machine includes a mounted drum and cutters

Model Number	Motor Specifications	Max Cutting Depth per Pass	Cutting Width	Dimensions (WxLxH)	Weight (lbs.)
TFP 260 Gas					
326.2000T	Honda GX240 Gas, 8 HP	1/4"	10"	17" x 44" x 45"	408
TFP 260 Electric					
326.2006T	415V, 50/60 Hz, 3-Phase, 7.5 HP	1/4"	10"	17" x 44" x 45"	408

SF11 Steel Deck Hammer



11 heads deliver 33,000 BPM

Fracture and reduce scale, corrosion and thick coatings in minutes – and reduce blast media costs

CS Unitec's Trelawny™ ScaleForce Eleven Pneumatic Deck Hammer will fracture and reduce scale, corrosion and thick coatings in minutes. The machine's low profile body and adjustable handle mean the deck hammer needs only 6" clearance for working under pipes and other constructions.

- Includes Vibro-Lo™ vibration reduction technology
- Optional spark resistant beryllium copper replacement heads to reduce risk of explosion in potentially hazardous areas
- Detachable taper fit cutter head reduces cost of replacement and extends piston life
- Optional vacuum shroud reduces hazardous and nuisance dust when used with TVS approved dust collectors



11 heads provide 33,000 BPM (11 x 3000 BPM)



Applications Include:

- Ship Decks
- Tank Bottoms
- Bridge Decks
- Floating Platforms

CS Unitec's Trelawny™ ScaleForce Eleven Pneumatic Deck Hammer operates with 8x less vibration than standard models. This tool utilizes vibration damping components to offset the hammer vibration created when the heads impact the workpiece.

SF11 Accessories

	Part No.
Cruciform Cutter Head	426.5351
Copper Beryllium (CuBe) Cruciform Cutter Head	606.5303
Bush Cutter Head	426.5352
Common Tapered Piston	612.5301
Vacuum Shroud	437.0100



Bush

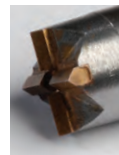

Cruciform

Copper Beryllium for use in potentially explosive areas



Optional dust shroud, P/N 437.0100, to collect dust and debris when connected to a dust collection vacuum.



See page 21 for air-powered dust collection vacuum – ATEX classified for use in Gas Zone 2 and Dust Zone 22.



ScaleForce Eleven (SF11) Pneumatic Deck Hammer

Model Number	Motor Specifications	Cutting Width	Blows per Minute	Dimensions (WxH)	Noise Level dB(A)	Vibration Levels m/s ²	Weight (lbs.)
SF11 with Cruciform Heads							
159.5910	70 CFM @ 90 PSI	10"	33,000	11.1" x 47.6"	113.1	5.76	79
SF11 with Copper Beryllium (CuBe) Heads							
159.5930	70 CFM @ 90 PSI	10"	33,000	11.1" x 47.6"	113.1	5.76	79
SF11 with Dust Shroud							
159.5912	70 CFM @ 90 PSI	10"	33,000	11.1" x 47.6"	113.1	5.76	83



Deck Descalers

Rapidly remove scale, rust, paint and other unwanted deposits

CS Unitec's Trelawny™ Trident Neptune Deck Descaler is ideal for the rapid removal of scale, rust, paint and other unwanted deposits on ship decks and other metal surfaces, leaving a receptive surface for priming/painting or coating application.

- 9' x 5/8" flexible shaft for wide coverage area
- Unique non-corrosive D-coupling with positive locking mechanism
- Two-skid base design keeps unit stable and upright; optional swivel base available



Trident Neptune Deck Descalers

Model Number	Motor Specifications	ISSA Number	IMPA Number	Cutter Speed (RPM)	Dimensions (LxWxH)
Pneumatic with Swivel Base					
340.490/S	68 CFM @ 90 PSI, 1.5 HP	55.077.00	59 12 81	3000	106" x 8.3" x 11.4"
Electric with Swivel Base					
340.TN/50/S	110V / .75 HP	55.077.00	59 12 41	2850	106" x 8.3" x 11.4"
340.TN/100/S	220V / .75 HP	55.077.00	59 12 42	3450	106" x 8.3" x 11.4"
Electric with Skid Base					
340.TN/S/110	110V / .75 HP	55.077.00	59 12 41	2850	106" x 8.3" x 11.4"
340.TN/S/220	220V / .75 HP	55.077.00	59 12 42	3450	106" x 8.3" x 11.4"

Standard equipment includes: 9' x 5/8" flexible shaft; heavy-duty leaf scaling head; 6-cutter scaling head; 6" dia. power brush, spanner set and hand guard.

SAFEWRENCH® SAFE Striking Wrench

Hands-free – secures itself in any position



Prevent Hand Injuries

Operate hammer with 2 hands



- Manufactured of CRV30 chrome vanadium steel
- Black coated surface for maximum rust protection

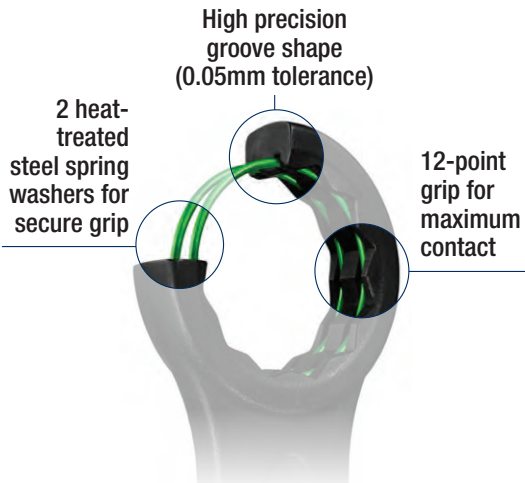

US Inch - Imperial

Part No.	Bolt Size
SW-3031S	1-1/4"
SW-3036S	1-7/16"
SW-3041S	1-5/8"
SW-3046S	1-13/16"
SW-3050S	2"
SW-3055S	2-3/16"
SW-3060S	2-3/8"
SW-3065S	2-9/16"
SW-3070S	2-3/4"

Metric

Part No.	Bolt Size
SW-2024S	24mm
SW-2027S	27mm
SW-2030S	30mm
SW-2032S	32mm
SW-2036S	36mm
SW-2041S	41mm
SW-2046S	46mm
SW-2050S	50mm
SW-2055S	55mm
SW-2060S	60mm
SW-2065S	65mm
SW-2070S	70mm
SW-2075S	75mm

Tools for Hot Work – Ex Zones

CS Unitec's heavy-duty pneumatic and hydraulic power tools and non-sparking hand tools are specifically designed, manufactured and tested for use in hazardous areas and Ex Zones.



RECIPROCATING SAWS
For cutting steel and pipe up to 6" dia.
See page 120



ATEX Certified
Air and Hydraulic Tools
See page 81 for ATEX details or visit
www.csunitec.com



PORTABLE HACKSAWS
For on-site cutting of pipe up to 30" OD and structural steel
See page 124

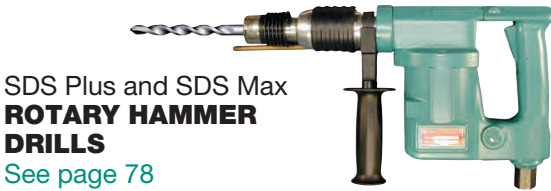

SDS Plus and SDS Max
ROTARY HAMMER DRILLS
See page 78



AIR CIRCULAR SAWS
7-1/2" and 9" dia., cut 90° and 45° angles up to 3-1/4" deep
See page 118



PORTABLE BAND SAWS
Cut up to 9"
See page 122



MAGNETIC DRILLS
For drilling up to 4" dia. holes



Explosion-proof
AXIAL FANS
12" to 24" diameter



Electric models available for some tools. Contact us for more information.

ATEX IMPACT WRENCHES



Safety Tools – Non-Sparking, Non-Magnetic

- High-quality non-sparking and non-magnetic safety tools
- Aluminum Bronze (AlBr) or Copper Beryllium (CuBe) alloy
- For Ex and hot work zones where hazardous, flammable or combustible materials are present
- Hammers, wrenches, sockets, wedges, chisels and more



TÜV Certified
for explosive atmospheres



For use in Ex and Hot Work Zones

Dust Collection Vacuums Electric • Pneumatic

Dust Collection Vacuums with HEPA Filtration

CS Unitec's dust extraction vacuums offer strong 157 CFM air flow and an electromagnetic pulse filter cleaning system to maximize vacuum power and dust collection.

- Ideal for use with power tools
- 99.995% HEPA filtration efficiency of particles down to 0.3 microns; automatic filter cleaning
- "Power Take Off" outlet activates the vacuum ON/OFF from the power tool switch
- Non-HEPA models available, 99.900% filtration efficiency
- Kit available to connect two power tools (P/N 198804)



Model CS 1445 H automatically "pulse" cleans filters without interrupting operation!



CS 1225 H

HEPA Vacuum Specifications

	CS 1225 H	CS 1445 H
Power	11 Amp	11 Amp
Air flow	157 CFM	157 CFM
Static Water Lift	98"	98"
Tank capacity	6.6 gal.	9 gal.
Weight	24.3 lbs.	24.3 lbs.
Filter P/N (2pk.)	428956	428956

Standard Vacuum Specifications

	CS 1225	CS 1445
Power	11 Amp	11 Amp
Air flow	157 CFM	157 CFM
Static Water Lift	98"	98"
Tank capacity	6.6 gal.	9 gal.
Weight	24.3 lbs.	24.3 lbs.
Filter P/N (2pk.)	416069	416069

Optional Filter Bags

Fleece filter bags for CS 1225 and CS 1445 - P/N 435305 (5-pack)

Plastic filter bags for CS 1225 and CS 1445 - P/N 421742 (5-pack)

We make no claim that use of a vacuum will eliminate contaminants. Wear an approved respirator mask and follow all appropriate OSHA safety regulations for proper ventilation, dust handling, eye protection, etc. when using a dust extraction grinder and vacuum.

Activate vacuum on/off from power tool controls

Air-Powered Dust Collection Vacuum – KAV 30 AIR

**Collection of dry dust/debris and non-flammable liquids
ATEX classified; antistatic vacuum and air-supply hose**



- Antistatic vacuum and air supply hose
- ATEX classified Ex II 2 GcT6 for use in Gas Zone 2 and Dust Zone 22
- Robust stainless steel construction
- Floor tool kit for general cleaning work
- Double filtration with optional 14" Permaflow filter
- Optional HEPA filter – for collection of hazardous dust
- Disposable paper filter or reusable cloth bag for wet use

KAV 30 AIR Vacuum Specifications

	Dry Model 303.10KAV30/D	Wet/Dry Model 303.10KAV30/WD
CFM @ 90 PSI	35	35
Output flow	70 CFM	70 CFM
Tank capacity	6.8 gal.	6.8 gal.
Weight	32 lbs.	32 lbs.
Paper Filter P/N (10pk.)	303.1030	303.1030
HEPA Filter P/N	303.1060	303.1060

Portable Magnetic Drills



MABasic Series p. 28-31
Capacity: \varnothing 1-3/8" to 3-1/16" cutter
Professional grade, versatile



MAB 155 p. 32
Capacity: \varnothing 1-1/2" cutter
For drilling in tight spaces



AutoMAB 350 p. 34
Capacity: \varnothing 1-1/2" cutter
Automatic feed – forward and reverse



AutoMAB 450 p. 35
Capacity: \varnothing 2" cutter; \varnothing 3/4" twist drill
Automatic feed – forward and reverse



MAB 465 p. 36
Capacity: \varnothing 2" cutter; \varnothing 5/8" twist drill
Reversible, 2-gear motor



MAB 485 & MAB 485 SB p. 38
Capacity: \varnothing 2-1/16" cutter; \varnothing 7/8" twist drill;
 \varnothing 15/16" tapping
Reversible, 2-gear motor
Swivel base (MAB 485 SB)



MAB 525 & MAB 525 SB p. 40
Capacity: \varnothing 2-1/2" cutter; \varnothing 1" twist drill;
 \varnothing 15/16" tapping
Reversible, 2-gear motor
Swivel base (MAB 525 SB)



MAB 825 KTS p. 42
Capacity: \varnothing 3-1/8" cutter; \varnothing 1-1/4" twist drill;
 \varnothing 1-3/16" tapping
Multi-axis positioning for boring, slotting, etc.
Reversible, 4-gear motor



MAB 825, MAB 825 V & MAB 845 p. 44
Capacity: \varnothing 4-1/16" cutter; \varnothing 1-1/4" twist drill;
 \varnothing 1-1/8" tapping
Auto feed (MAB 825 V) Swivel base (MAB 845)
Reversible, 4-gear motor



MAB 1300 & MAB 1300 V p. 46-49
Capacity: \varnothing 5-1/8" cutter
 \varnothing 1-3/4" twist drill
 \varnothing 1-5/8" tapping
Reversible, 4-gear motor
Auto-feed and reverse (MAB 1300 V)
The ultimate in power



AIRBOR™ AB-4300 p.50
Pneumatic power
Capacity: \varnothing 2-1/16" cutter; \varnothing 1/2" twist drill
ATEX for hazardous environments



HB 4400 p. 51
Hydraulic power
Capacity: \varnothing 2-1/16" cutter;
 \varnothing 1/2" twist drill
For marine, construction
and underwater applications



Model 2 1345 0010 p. 52
Hydraulic power
Capacity: \varnothing 4" cutter; \varnothing 1-1/4" twist drill;
 \varnothing 1" tapping
ATEX certified

Warranty

Products of CS Unitec, Inc. are warranted to be free from defects in material and workmanship for one year from date of purchase. This warranty does not apply to normal wear or products which have been abused, misused, modified or repaired by someone other than CS Unitec, Inc. or its Authorized Service Representatives.

If a product proves defective in material or workmanship within one year after purchase, return it to CS Unitec, Inc. or an Authorized Service Center, transportation prepaid. CS Unitec, Inc. will, at its option, repair or replace defective products free of charge.

CS Unitec, Inc.'s sole liability and your exclusive remedy under this warranty is limited to repair or replacement of the defective product. There are no other warranties expressed or implied and CS Unitec, Inc. shall not be liable for incidental, consequential or special damages, or expenses excepting only the cost or expense of repair or replacement as described above.

Safety

Operators of any power tool should use appropriate safety precautions for work being performed. This includes safety chains, eye protection, hearing protection, gloves and more. Follow instructions included in operating manual.

Annular Cutters

p. 54-64



HSS Unibroach® p. 56-57

High-speed steel
7/16" to 5-1/8" diameter
1", 2" and 3" depth
Special sizes available



TiAlN Carbide-Coated Unibroach™ p. 58-59

For higher working temperatures
7/16" to 5-1/8" diameter
1", 2" and 3" depth



TCT Hornet p. 60-61

Tungsten carbide-tipped
1/2" to 5-1/8" diameter
1", 2-3/8" and 3-3/8" depth
Special sizes available



One-Touch TCT Cutters p. 62

Rail Cutters & Cobalt Cutters p. 63

Carbide-Tipped Hole Saws p. 64

Accessories

p. 65-71



Drilling Starter Kits p. 65

Lubricants and Pilot Pins p. 66

Arbors and Drill Chucks p. 67

Extensions and Tapping Tools p. 68

Countersinks, Drill/Taps and Chip Guard p. 68

MobilCLAMP p. 69

Convert magnetic drilling machine to bench drill

Drilling Stand and Vise p. 69

Convert hand drill to drill press

Vacuum Plates p. 70

For channeled plates and smooth surfaces

Metal Chip Cleanup Tools p. 70

Pipe Saddle Clamp System p. 71

Safe, secure drilling of pipes and tubular material



Custom Machines & Motors, Hand-Held Drills, Drive Units and More

p. 72-80



Electric, Slow-Speed Electric Drills & Drive Units p. 72-73

Electric Drive Units/Special Motors p. 74

Custom-Engineered Machines p. 75

Pneumatic Drills and Drive Units p. 76

Corner Drills and Drive Units p. 77

Pneumatic/Hydraulic Rotary Hammers p. 78

Pneumatic Woodboring Drills and AirPac p. 79

Pneumatic/Hydraulic Nut Runners p. 80



Portable Magnetic Drilling Machines

**Fast, accurate hole cutting...
on the job site or in the shop!**



Designed for continuous operation, CS Unitec's portable magnetic drills are ideal for drilling structural steel and virtually any metal. We offer the most compact, powerful and reliable series of portable magnetic drills for holes up to 5-1/8" diameter. All CS Unitec drills are heavy-duty for use in construction and industry. Our complete line includes electric, pneumatic and hydraulic tools. They are available for prompt delivery.

CS Unitec is the industry leader in:

- Power-to-weight ratios
- Strongest clamping force with high-density (HD) dual-coil magnets
- Magnetic drills for tapping
- Annular Cutters: TiAIN, HSS, cobalt steel and carbide-tipped

Our drills have unique features:

- Longest drill stroke in the industry
- Variable-speed, multiple-gear models
- Electric, pneumatic and hydraulic power
- Reversible motors for tapping
- Swivel base stand for hard-to-reach areas
- Battery-operated for on-site cordless drilling



Rugged construction and sophisticated functionality.

Intuitive magnets, ergonomic controls and simple operation for superior cuts.

Overheating Protection with CoolMag

COOLMAG™ Electromagnets

ensure that the magnet does not overheat. When the magnet is switched on for long periods of time, the coils could overheat or even burn out. The CoolMag feature reduces the power of the magnets when the drill motor is not active. Therefore, it won't build up heat.

CS Unitec high-density dual-coil magnets are ground, not cast, and are wound into two circles to increase the surface area and density of the magnetic field.



Keyless, quick-change system for annular cutters saves time and money. Just twist and lock.



Twist Drilling



Tapping



Reaming

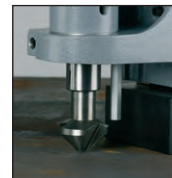

Countersinking

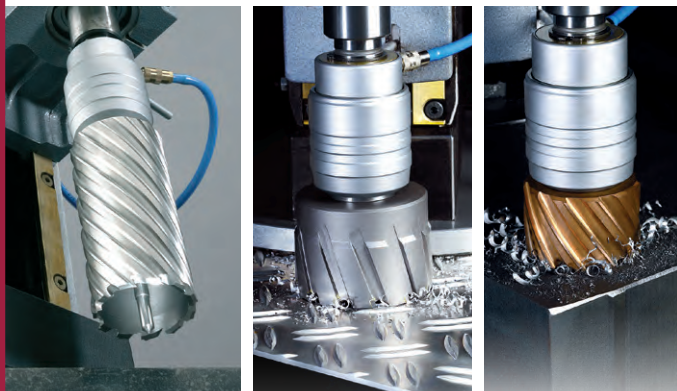

Custom machines for unique applications

Our engineers can create a drill, drill rig, or other application-specific arrangement to meet your needs.

See page 75 for more information, or call 1-800-700-5919 for design assistance.

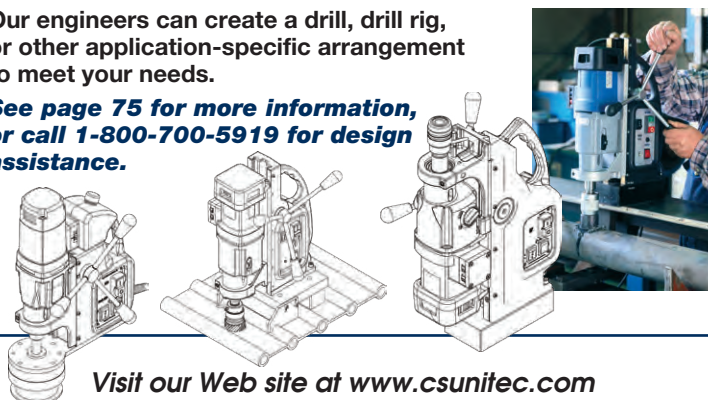

PORTABLE MAGNETIC DRILLS

The value is in the engineering...
the payback is in the performance.

IQ Magnetic System for Active Safety

Magnetic force is the key to safety and success.

The magnetic force of your magnet depends on a number of factors:

- ▶ Thickness of material being drilled
- ▶ Coatings or paint layers on material
- ▶ Chips, dirt or grease between the magnet and the material

SafeMag
System

**Electronic Safety
Shutoff Sensor**

The **SAFEMAG™ System** measures whether the magnet has sufficient adhesive force on the material. An LED indicator on the switch panel warns you of insufficient magnetic force (**Red Light**) or tells you if the correct force is present (**Green Light**).



LED red... insufficient magnetic force. Drilling should not take place. Possible causes are too-thin material, coatings of paint, scale or zinc.

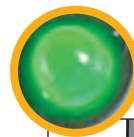
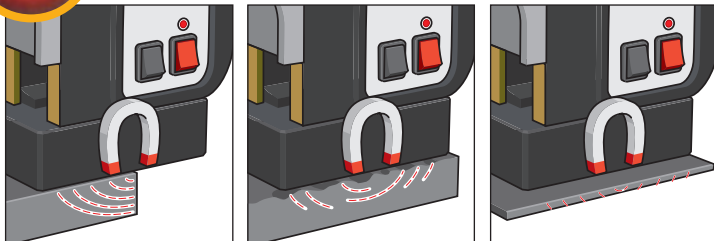

LED green... the magnetic adhesion meets the minimum requirements. Drilling can take place.

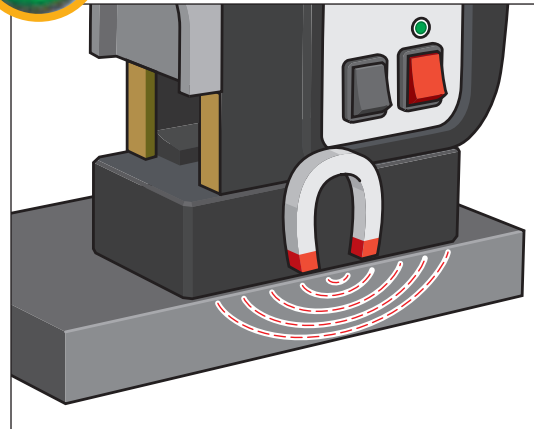

Our **Electronic Safety Shutoff Sensor** automatically shuts down the drill motor if the magnet loses contact with the material. This emergency-off feature helps to protect both operator and equipment.

Integrated cable routing: MAB Series

The new generation of our MAB portable magnetic drilling machines has been developed for increased safety. This includes complete cable routing within the casing.

- ▶ No threading and getting caught
- ▶ No tearing or snapping off

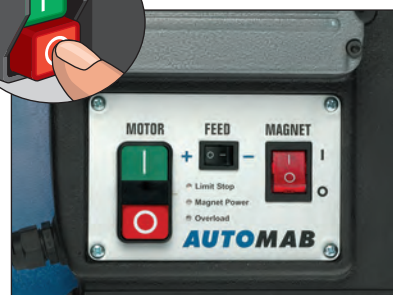
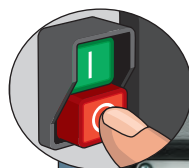
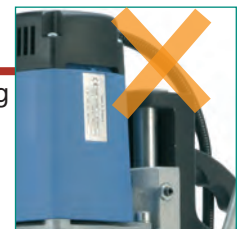

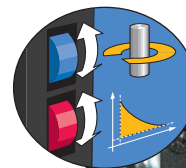

Simple, ergonomic arrangement of controls for one-handed operation. Emergency-off function for quick shutdown.



High power at low speeds. Electronic torque control prevents damage to motor.

Magnetic Drill Comparison Chart



	MABasic 200	MABasic 400	MABasic 450	MABasic 850	MAB 155	AutoMAB 350	AutoMAB 450	MAB 465
	Page 28	Page 29	Page 30	Page 31	Page 32	Page 34	Page 35	Page 36
Annular Cutters Diameter (ø)	up to ø 1-3/8"	up to ø 1-5/8"	up to ø 1-3/4"	up to ø 3-1/16"	up to ø 1-1/2"	up to ø 1-1/2"	up to ø 2"	up to ø 2"
Twist Drills Diameter (ø)	up to ø 1/2"	up to ø 5/8"	up to ø 3/4"	up to ø 1-1/4"		up to ø 1/2"	up to ø 3/4"	up to ø 5/8"
Tapping Diameter (ø)								up to ø 5/8"
Countersinking Diameter (ø)								up to ø 1-1/2"
Reaming Diameter (ø)								
Stroke	6-1/3"	6-1/3"	6-1/3"	10"	1-1/2"	6"	6"	6-1/3"
Weight	27 lbs.	27 lbs.	29 lbs.	53 lbs.	24 lbs.	33 lbs.	35-1/4 lbs.	29 lbs.
Speed Range 1	450 RPM	430 RPM	250 RPM	110 RPM	460 RPM	460 RPM	250 RPM	50-250 RPM
Speed Range 2		760 RPM	450 RPM	175 RPM			450 RPM	100-450 RPM
Speed Range 3				245 RPM				
Speed Range 4				385 RPM				
								✓
								✓
						✓	✓	✓
Electronic Safety Shutoff Sensor	✓	✓	✓		✓			✓
Tool Holder	Set Screw	Set Screw	Set Screw	Set Screw	Set Screw	Set Screw	Set Screw	Set Screw
Morse Taper (MT)			MT2				MT2	
Safety Friction Clutch								
Torque Control								
Swivel/Adjustable Base								
Magnet Size	6-5/8" x 3-1/3"	6-5/8" x 3-1/3"	6-5/8" x 3-1/3"	8-5/8" x 4-1/3"	6-5/16" x 3-3/16"	6-5/8" x 3-1/3"	6-5/8" x 3-1/3"	6-5/8" x 3-1/3"



MAB 485 MAB 485 SB	MAB 525 MAB 525 SB	MAB 825 KTS	MAB 825 MAB 825 V MAB 845	MAB 1300 MAB 1300 V	AIRBOR™	HB 4400	Model 2 1345 0010	<i>Special Features</i>
<i>Page 38</i>	<i>Page 40</i>	<i>Page 42</i>	<i>Page 44</i>	<i>Page 46</i>	<i>Page 50</i>	<i>Page 51</i>	<i>Page 52</i>	
up to ø 2-1/16"	up to ø 2-1/2"	up to ø 3-1/8"	up to ø 4-1/16"	up to ø 5-1/8"	up to ø 2-1/16"	up to ø 2-1/16"	up to ø 4"	Max. hole diameter up to 5-1/8"
up to ø 7/8"	up to ø 1"	up to ø 1-1/4"	up to ø 1-1/4"	up to ø 1-3/4"	up to ø 5/8"	up to ø 1/2"	up to ø 1-1/4"	Max. twist drilling up to 1-3/4"
up to ø 15/16"	up to ø 15/16"	up to ø 1-3/16"	up to ø 1-1/8"	up to ø 1-5/8"			up to ø 1"	Max. tapping up to 1-5/8"
up to ø 1-5/8"	up to ø 2"	up to ø 2"	up to ø 2"	up to ø 3"			up to ø 2"	
up to ø 7/8"	up to ø 7/8"	up to ø 1-1/4"	up to ø 1-1/4"	up to ø 2"			up to ø 1-1/8"	
6-1/3"	6-1/3"	10"	10"	3.35" (12" w/out retainer)	up to 10-1/4"	up to 3-3/4"	12"	
29 lbs.	35 lbs.	99 lbs.	55 lbs.	112 lbs.	43 lbs.	48-1/2 lbs.	50 lbs.	
50-250 RPM	70-280 RPM	40-110 RPM	40-110 RPM	30-80 RPM	400 RPM	0-630 RPM	40-250 RPM	Pneumatic Hydraulic
100-450 RPM	180-580 RPM	65-175 RPM	65-175 RPM	50-120 RPM				
		140-360 RPM	140-360 RPM	130-350 RPM				
		220-600 RPM	220-600 RPM	210-550 RPM				
✓	✓	✓	✓	✓			✓	Allows thread cutting
✓	✓	✓	✓	✓				Overheating protection
✓	✓	✓	✓	✓				Magnet adhesion indicator
✓	✓		✓	✓				Shuts down motor if magnetic contact lost
Quick-change keyless	Quick-change keyless	Set Screw	Quick-change keyless	Set Screw	Set Screw	Set Screw	Set Screw	
MT2	MT3	MT3	MT3	MT4			MT3	
		✓	✓	✓				
	✓	✓	✓	✓				
✓	✓	✓	✓					Swivel/adjustable base
6-5/8" x 3-1/3"	7-1/8" x 3-1/2"	8-11/16" x 8-11/16"	8-5/8" x 4-1/3"	14" x 4-3/4"	8-3/4" x 3-1/2"	7-1/4" x 3"	11-11/16" x 4"	

MABasic 200



Cutter capacity
1 3/8" dia.

Heavy-duty, purpose-built, single-speed workhorse

Powerful • Reliable

- Strong 8.2 Amp motor
- Compact, lightweight and portable – 12-1/4" high, 27 lbs.

Drill up to 1-3/8" dia.

- Uses annular cutters up to 1-3/8" dia.; 6-1/3" stroke
- Twist drilling capacity up to 1/2" dia.
- 3-1/3" stroke with included geared chuck
- Internal lubrication system



With included 1/2" geared chuck (IBC 18), this model easily converts to a standard drill press with a 3 1/3" stroke for conventional twist drills.

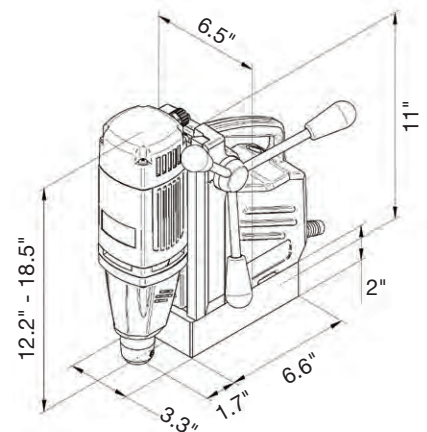

Equipped with Electronic Safety Shutoff Sensor (see p. 25)



Standard Equipment includes lubrication bottle, 3/4" weldon arbor, 1/2" geared chuck, safety strap, carabin hook, allen keys, pilot pin and carrying case.



MABasic 200 Specifications

Motor Power	8.2 Amp / 110 Volt
Weight	27 lbs.
Hole Capacity	1 3/8" dia.
Twist Drill Capacity	1/2" dia.
Speed	450 RPM
Magnet Base Size	6 5/8" L x 3 1/3" W
Dimensions	12 1/4" H x 9" L x 6 1/2" W
Magnetic Force (1" plate)	3080 lbs.
Arbor Bore	3/4" Weldon Shank
Internal Lubrication	Oil Bottle Included

➤ Annular Cutters: pages 54-64 ➤ Accessories: pages 65-71

MABasic 400



Two gears – powerful and reliable

Powerful • Reliable

- 9.5 Amp double-insulated motor
- 3/4" direct arbor

Drill up to 1-5/8" dia.

- Uses annular cutters up to 1-5/8" dia.
- Twist drilling capacity up to 5/8" dia.
- 3-1/3" stroke with chuck
- Internal lubrication system
- Compact and lightweight

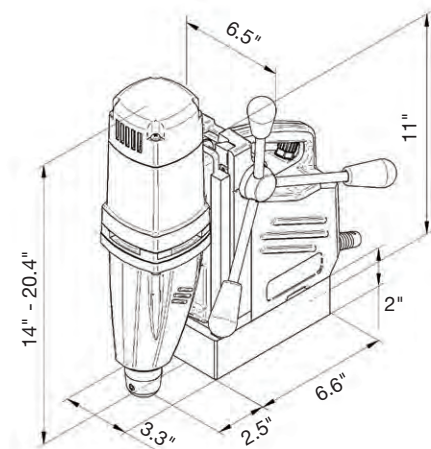

With included 1/2" geared chuck (IBC 18), the MABasic 400 easily converts to standard drill press with a 3 1/3" stroke for conventional twist drills.

Equipped with Electronic Safety Shutoff Sensor (see p. 25)



MABasic 400 Specifications

Motor Power	9.5 Amp / 110 Volt
Weight	27 lbs.
Hole Capacity	1 5/8" dia.
Twist Drill Capacity	5/8" dia.
Speed	430 / 760 RPM (2 gears)
Magnet Base Size	6 5/8" L x 3 1/3" W
Dimensions	14" H x 9 1/2" L x 6 1/2" W
Magnetic Force (1" plate)	3080 lbs.
Arbor Bore	3/4" Weldon Shank
Internal Lubrication	Oil Bottle Included



Standard Equipment includes lubrication bottle, 3/4" weldon arbor, 1/2" geared chuck, safety strap, carabin hook, allen keys, pilot pin and carrying case.



➤ Annular Cutters: pages 54-64 ➤ Accessories: pages 65-71

MABasic 450



Cutter capacity
1 3/4" dia.

Professional-grade, two-speed versatility

Powerful • Reliable

- 10.5 Amp double-insulated motor
- MT2 – 3/4" direct arbor with automatic cooling

Drill up to 1-3/4" dia.

- Uses annular cutters up to 1-3/4" dia.
- Twist drilling capacity up to 3/4" dia.
- Internal lubrication system
- Compact and lightweight



With included 3/4" geared chuck (IBC 22), the MABasic 450 easily converts to standard drill press for conventional twist drills.

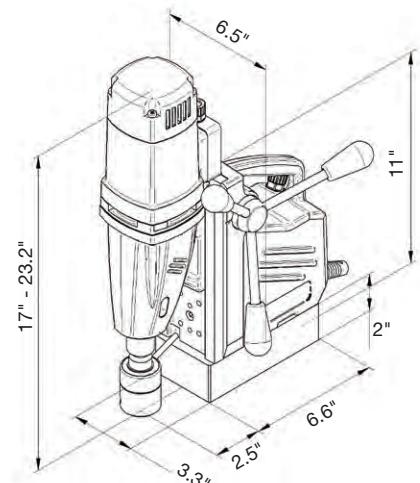

Equipped with Electronic Safety Shutoff Sensor (see p. 25)



MABasic 450 Specifications

Motor Power	10.5 Amp / 110 Volt
Weight	29 lbs.
Hole Capacity	1 3/4" dia.
Twist Drill Capacity	3/4" dia.
Speed	250 / 450 RPM (2 gears)
Magnet Base Size	6 5/8" L x 3 1/3" W
Dimensions	17" H x 9 1/2" L x 6 1/2" W
Magnetic Force (1" plate)	3080 lbs.
Arbor Bore	3/4" Weldon Shank
Spindle	MT2
Internal Lubrication	Oil Bottle Included

Standard Equipment
includes lubrication bottle, 3/4" geared chuck, safety strap, carabin hook, allen keys, pilot pin and carrying case.



➤ Annular Cutters: pages 54-64 ➤ Accessories: pages 65-71

MABasic 850



4-gear, powerful motor for demanding jobs

Powerful • Reliable

- 16 Amp double-insulated motor
- MT3 – 3/4" direct arbor with automatic cooling
- 19-3/8" high, 53 lbs.
- High-speed, 4-speed gearbox

Drill up to 3-1/16" dia.

- Uses annular cutters up to 3-1/16"; 10" stroke
- Twist drilling capacity up to 1-1/4" dia.
- Internal lubrication system



With included 3/4" chuck (IBC 21), this model easily converts to a standard drill press for conventional twist drills.

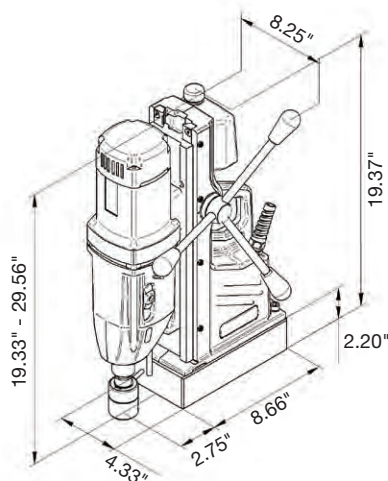

MABasic 850 Specifications

Motor Power	16 Amp / 110 Volt
Weight	53 lbs.
Hole Capacity	3 1/16" dia.*
Twist Drill Capacity	1 1/4" dia.
Speed	1: 110 RPM, 2: 175 RPM 3: 245 RPM, 4: 385 RPM
Magnet Base Size	8 5/8" L x 4 1/3" W
Dimensions	19 3/8" H x 11 5/8" L x 8 1/4" W
Magnetic Force (1" plate)	6000 lbs.
Arbor Bore	3/4" Weldon Shank
Spindle	MT3
Internal Lubrication	Included

* 3-1/16" cutters have 1-1/4" Weldon shank. Part No. ZIA 30/32 arbor is required.

Standard Equipment includes 3/4" geared chuck, safety strap, carabin hook, allen keys, pilot pin and carrying case.



➤ [Annular Cutters: pages 54-64](#) ➤ [Accessories: pages 65-71](#)

MAB 155



Cutter capacity
1 1/2" dia.

Horizontal motor mount for drilling in tight spaces

Powerful • Reliable

- 9.25 Amp double-insulated motor
- Ultra compact, 7" high
- Ratchet-style advancing mechanism for work in spaces with limited clearance
- Lightweight, 24 lbs.
- Intelligent electronic torque control
- Designed for continuous use

Drill up to 1-1/2" dia.*

- Uses annular cutters up to 1-1/2" dia.

Integrated Safety

- Emergency-off function
- Internal cable routing
- Simple, ergonomic arrangement of controls for one-handed operation

Internal cable routing protects the motor power cord from external damage



Ratchet-style advancing mechanism for work in spaces with limited clearance.

Equipped with Electronic Safety Shutoff Sensor (see p. 25)

MAB 155 uses standard 3/4" shank annular cutters



Cutter Capacity



ø 1 1/2"

Stroke (length)



1 1/2"

Speed Range (RPM)



460

* Model MAB 155 accepts cutters with a 3/4" weldon shank and a maximum depth of cut of 1-1/2".

Switches for power and magnet adhesion are arranged for simple, uncomplicated operation.



MAB 155 Specifications

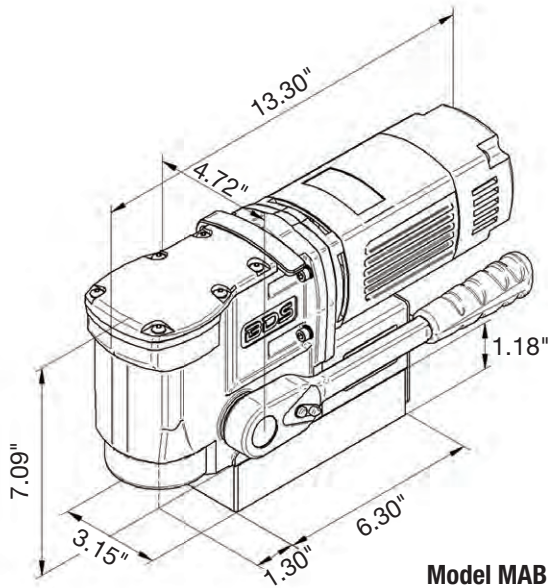

Model MAB 155

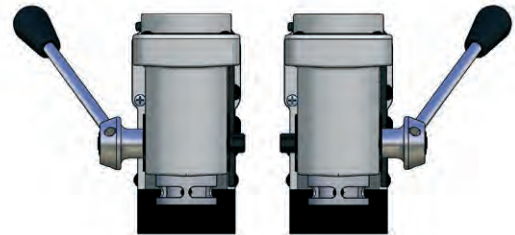

Advancing lever can be mounted on either the left or right side of the MAB 155.

MABasic 155 Specifications

Motor Power	9.25 Amp / 110 Volt
Weight	24 lbs.
Hole Capacity	1 1/2" dia.
Speed	460 RPM
Magnet Base Size	6 ⁵ / ₁₆ " L x 3 ³ / ₁₆ " W
Dimensions	7 ¹ / ₈ " H x 13 ⁵ / ₁₆ " L x 4 ³ / ₄ " W
Magnetic Force (1" plate)	2640 lbs.
Arbor Bore	3/4" Weldon Shank

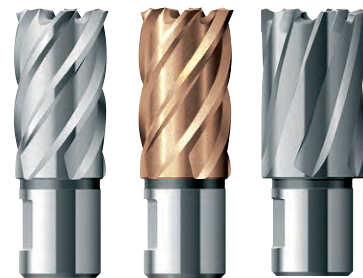

Model MAB 155 accepts cutters with 3/4" weldon shank. This unit has a maximum depth of cut of 1-1/2".

See pages 56-61 for our HSS, TiAIN and Carbide-tipped cutters.

Standard Equipment

- 1 Magnetic drilling machine
- 1 Pilot pin
- 1 Plastic carrying case
- 1 Safety chain
- 1 Hexagon socket screw key SW 4
- 1 Operating manual
- 1 Warranty certificate

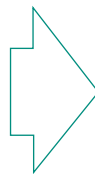

Standard Equipment also includes safety strap, carabin hook and allen keys.



AutoMAB 350



Cutter capacity
1 1/2" dia.

Compact drill with automatic feed – forward and reverse



Powerful • Reliable

- 10.5 Amp double-insulated motor
- Designed for continuous use
- Lightweight, 33 lbs.
- Automatic feed with auto stop and retraction
- Power feed automatically controls drill pressure to maintain optimal RPM and feed rate

Drill up to 1-1/2" dia.

- Uses annular cutters up to 1-1/2" dia.
- Twist drilling capacity up to 1/2" dia.
- 6" stroke, 3-1/3" stroke with chuck
- Integrated cutting oil reservoir
- Automatic internal lubrication

Integrated Safety

- Simple, ergonomic arrangement of controls for one-handed operation



With optional 1/2" geared chuck (IBC 18), this model easily converts to a standard drill press with a 3 1/3" stroke for conventional twist drills.



Model AutoMAB 350 Specifications

Motor Power	10.5 Amp / 110 Volt
Weight	33 lbs.
Hole Capacity	1 1/2" dia.
Drilling Depth	2-3/8" with pilot pin 4-3/8" without pilot pin
Speed	460 RPM
Magnet Base Size	6 5/8" L x 3 1/3" W
Dimensions	12 1/4" H x 8 3/4" L x 7 3/4" W
Magnetic Force (1" plate)	3750 lbs.
Arbor Bore	3/4" Weldon Shank
Automatic Lubrication	Included
Spindle	–

Standard Equipment includes auto lubrication, safety strap, carabin hook, allen keys and steel carrying case.[†]

[†] Steel case intended mainly for shipping purposes; damage may occur in transit.

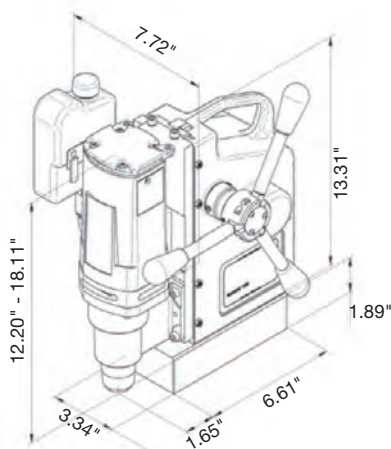

➤ Annular Cutters: pages 54-64 ➤ Accessories: pages 65-71

AutoMAB 450



Cutter capacity
2" dia.



Powerful • Reliable

- 10.5 Amp double-insulated motor
- Designed for continuous use
- Lightweight, 33 lbs.
- Automatic feed with auto stop and retraction
- Power feed automatically controls drill pressure to maintain optimal RPM and feed rate

Drill up to 2" dia.*

- Uses annular cutters up to 2" dia. (*with TCT Carbide cutters, 1-3/4" dia. with all other annular cutters)
- Twist drilling capacity up to 3/4" dia.
- 6" stroke, 3-1/3" stroke with chuck
- Integrated cutting oil reservoir
- Automatic internal lubrication

Integrated Safety

- Simple, ergonomic arrangement of controls for one-handed operation



With an optional 1/2" chuck (Part No. IBC 18), the AutoMAB 450 easily converts to a standard drill press for conventional twist drills. An optional 3/4" geared chuck is also available (Part No. IBC 22).

Model AutoMAB 450 Specifications

Motor Power	10.5 Amp / 110 Volt
Weight	35 ¹ / ₄ lbs.
Hole Capacity	2" dia.*
Drilling Depth	2-3/8" with pilot pin 4-3/8" without pilot pin
Speed	250 / 450 RPM (2 gears)
Magnet Base Size	6 ⁵ / ₈ " L x 3 ¹ / ₃ " W
Dimensions	16 ⁷ / ₈ " H x 9 ¹ / ₈ " L x 7 ³ / ₄ " W
Magnetic Force (1" plate)	3750 lbs.
Arbor Bore	3/4" Weldon Shank
Automatic Lubrication	Included
Spindle	MT2

Standard Equipment includes auto lubrication, safety strap, carabin hook, MT2 drift key, allen keys and steel carrying case.†

† Steel case intended mainly for shipping purposes; damage may occur in transit.

* 2" dia. with TCT Annular Cutters; 1-3/4" capacity with all other annular cutters

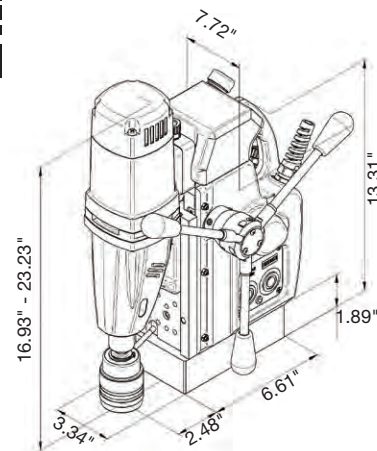

➤ **Annular Cutters:** pages 54-64 ➤ **Accessories:** pages 65-71

MAB 465

Cutter capacity
2" dia.

Reversible motor ideal for tapping and twist drilling



Powerful • Reliable

- 10.5 Amp double-insulated motor
- 14-1/8" high, 29 lbs.
- High-speed, variable-speed oilbath gearbox, ideal for annular cutters and twist drills
- Designed for continuous use

Drill up to 2" dia. Tap up to 5/8" dia.

- Uses annular cutters up to 2"* dia.
- Twist drilling capacity up to 5/8" dia.
- Tapping capacity up to 5/8" dia.
- Integrated cutting oil reservoir
- Automatic internal lubrication

Integrated Safety

- Green/Red LED magnetic force indicator for safe operation
- Internal cable routing
- Simple, ergonomic arrangement of controls for one-handed operation
- Emergency-off function

Equipped with Electronic Safety Shutoff Sensor (see p. 25)

* 2" with TCT Annular Cutters;
1-5/8" capacity with all other cutters

REVERSIBLE







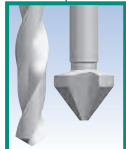

Internal cable routing protects the motor power cord from external damage

Optional Geared Chucks

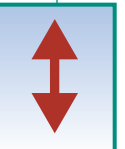
With an optional 1/2" geared chuck (Part No. IBC 18), this model easily converts to a standard drill press with a 5" stroke for conventional twist drills.

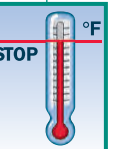
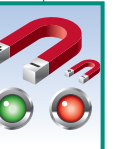

Cutter Capacity	Twist Drill / Countersink	Tap	Stroke (length)	2-gear Variable Speed (RPM)	Electronics	Overheat Protection	Magnet Force Indicator	Reversible (CW/CCW)
								
Ø 2"	Ø 5/8" / Ø 1 1/2"	Ø 5/8"	6 1/3"	50-250 100-450	Variable-speed Control	CoolMag™	SafeMag™	

➤ Annular Cutters: pages 54-64 ➤ Accessories: pages 65-71

MAB 465 Specifications



Model MAB 465

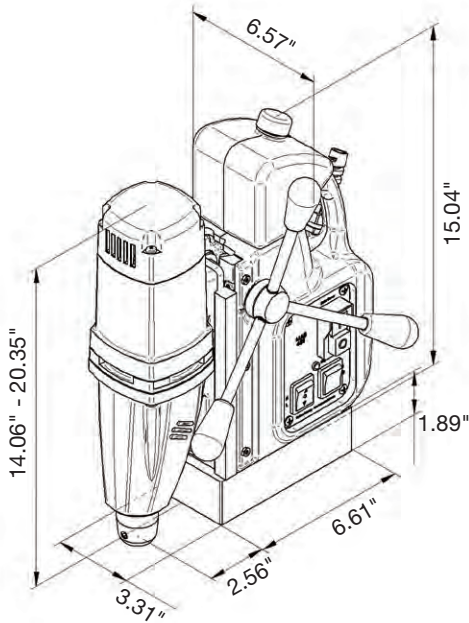

MABasic 465 Specifications

Motor Power	9.5 Amp / 110 Volt
Weight	29 lbs.
Hole Capacity	2" dia.
Twist Drill Capacity	5/8" dia.
Speed	50-250 and 100-450 RPM
Magnet Base Size	6 ⁵ / ₈ " L x 3 ¹ / ₃ " W
Dimensions	14 ¹ / ₈ " H x 9 ⁵ / ₈ " L x 6 ¹ / ₂ " W
Magnetic Force (1" plate)	3750 lbs.
Arbor Bore	3/4" Weldon Shank
Automatic Lubrication	Included



* 2" with TCT Annular Cutters; 1-5/8" capacity with all other cutters

Standard Equipment

- 1 Magnetic drilling machine
- 1 Manual arbor with set screws, Weldon 3/4"
- 2 Pilot pins - 1" and 2" depth
- 1 Safety chain
- 1 Warranty certificate

Standard Equipment

also includes molded plastic carrying case, operating manual, auto lubrication, safety strap and allen keys.

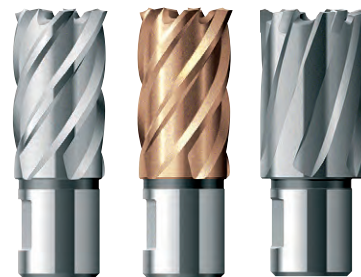

See pages 56-61 for our HSS, TiAIN and Carbide-tipped cutters.



➤ Annular Cutters: pages 54-64 ➤ Accessories: pages 65-71

MAB 485 & MAB 485 SB

Cutter capacity
2 1/16" dia.

Versatile for workshop and assembly applications



Powerful • Reliable

- 10.5 Amp double-insulated motor
- 17-1/4" high, 29 lbs.
- High-speed, variable-speed oilbath gearbox, ideal for annular cutters and twist drills
- Designed for continuous use
- Intelligent electronic torque control

Drill up to 2-1/16" dia. Tap up to 15/16" dia.

- Uses annular cutters up to 2-1/6" dia.
- Twist drilling capacity up to 7/8" dia.
- Tapping capacity 3/16" to 15/16" dia.
- Integrated cutting oil reservoir
- Automatic internal lubrication
- Swivel base (model MAB 485 SB)

Keyless Cutter Mount

- Quick-change keyless cutter system for 3/4" Weldon shank, standard
- Also includes manual arbor for 3/4" Weldon shank (MT2) with set screws



Integrated Safety

- Green/Red LED magnetic force indicator for safe operation
- Internal cable routing
- Simple, ergonomic arrangement of controls for one-handed operation
- Emergency-off function

Internal cable routing protects the motor power cord from external damage







Equipped with Electronic Safety Shutoff Sensor (see p. 25)

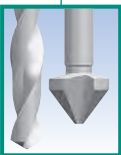
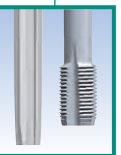

With included 3/4" chuck (IBC 22), this model easily converts to a standard drill press for conventional twist drills.

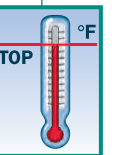

Model MAB 485 SB features a swivel base providing 20° movement left and right and 5/8" forward and backward.

Cutter Capacity	Twist Drill / Countersink	Ream / Tap	Stroke (length)	2-gear Variable Speed (RPM)	Electronics	Overheat Protection	Magnet Force Indicator	Reversible (CW/CCW)
								
ø 2 1/16"	ø 7/8" / ø 1 5/8"	ø 7/8" / ø 15/16"	6 1/3"	50-250 100-450	Variable-speed Control	CoolMag™	SafeMag™	

➤ Annular Cutters: pages 54-64 ➤ Accessories: pages 65-71

MAB 485 & MAB 485 SB Specifications

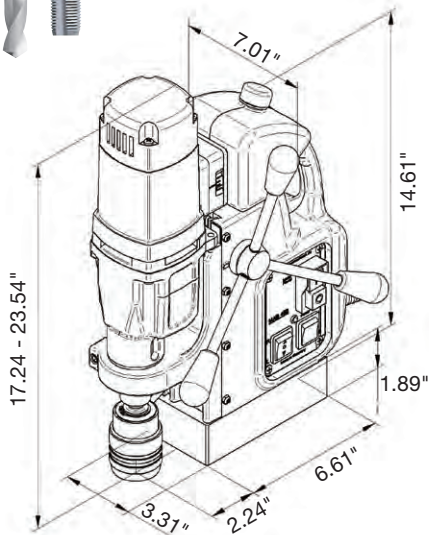

Model MAB 485
& MAB 485 SB



Model MAB 485 Specifications

Motor Power	10.5 Amp / 110 Volt
Weight	29 lbs.
Hole Capacity	2 ¹ / ₁₆ " dia.
Twist Drill Capacity	7/8" dia.
Speed	50-250 and 100-450 RPM
Magnet Base Size	6 ⁵ / ₈ " L x 3 ¹ / ₃ " W
Dimensions	17 ¹ / ₄ " H x 11 ⁵ / ₈ " L x 7" W
Magnetic Force (1" plate)	3750 lbs.
Arbor Bore	3/4" Weldon Shank
Spindle	MT2
Automatic Lubrication	Included
Swivel Base	Order MAB 485 SB



Standard Equipment

- 1 Magnetic drilling machine
- 1 Quick-change arbor system
KEYLESS Weldon 3/4"
- 1 Manual arbor with set screws, Weldon
3/4", MT2
- 1 Geared chuck, 3/4"
- 2 Pilot pins - 1" and 2" depth
- 1 Safety chain
- 1 Drift key MT2
- Tap collet adapters - 1/4", 3/8", 1/2" and 3/4"
- 1 Warranty certificate

Standard Equipment
also includes molded plastic carrying case, operating manual, auto lubrication, safety strap, carabin hook and allen keys.



Shown with optional Pipe Saddle Clamp System for safe, secure drilling of pipes and tubular material. See page 71 for details.



MAB 525 & MAB 525 SB



High power, ideal for production use



Powerful • Reliable

- 14.5 Amp double-insulated motor
- 19" high, 35 lbs.
- High-speed, 2-speed oilbath gearbox, ideal for annular cutters and twist drills
- Designed for continuous use
- Intelligent electronic torque control

Drill up to 2-1/2" dia. Tap up to 15/16" dia.

- Uses annular cutters up to 2-1/2" dia.
- Twist drilling capacity up to 1" dia.
- Tapping capacity up to 15/16" dia.
- Integrated cutting oil reservoir
- Automatic internal lubrication
- Swivel base (model MAB 525 SB)

Keyless Cutter Mount

- Quick-change keyless cutter system for 3/4" Weldon shank
- Also includes manual arbor for 3/4" Weldon shank (MT3) with set screws

Integrated Safety

- Green/Red LED magnetic force indicator for safe operation
- Internal cable routing
- Simple, ergonomic arrangement of controls for one-handed operation
- Emergency-off function

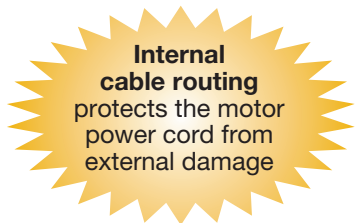







Equipped with Electronic Safety Shutoff Sensor (see p. 25)

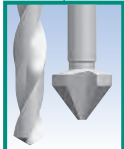
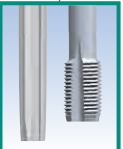

With the included 3/4" chuck (Part No. IBC 21), this model easily converts to a standard drill press with a 5" stroke for conventional twist drills.

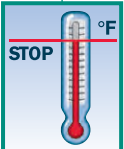
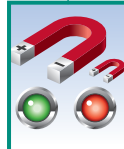

Model MAB 525 SB features a swivel base providing 20° movement left and right and 5/8" forward and backward.

Cutter Capacity	Twist Drill / Countersink	Ream / Tap	Stroke (length)	2-gear Variable Speed (RPM)	Electronics	Overheat Protection	Magnet Force Indicator	Reversible (CW/CCW)
 Ø 2 1/2"	 Ø 1" / Ø 2"	 Ø 7/8" / Ø 15/16"	 6 1/3"	 70-280 180-580	 Variable-speed Control	 CoolMag™	 SafeMag™	

➤ *Annular Cutters: pages 54-64* ➤ *Accessories: pages 65-71*

MAB 525 & MAB 525 SB Specifications

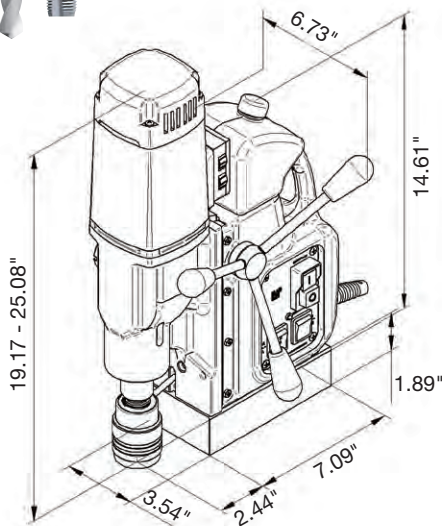

Model MAB 525
& MAB 525 SB



Model MAB 525 Specifications

Motor Power	14.5 Amp / 110 Volt
Weight	35 lbs.
Hole Capacity	2 1/2" dia.
Twist Drill Capacity	15/16" dia.
Speed	70-280 and 180-580 RPM
Magnet Base Size	7 1/8" L x 3 1/2" W
Dimensions	19" H x 11 3/4" L x 6 3/4" W
Magnetic Force (1" plate)	4500 lbs.
Arbor Bore	3/4" Weldon Shank
Spindle	MT3
Automatic Lubrication	Included
Swivel Base	Order MAB 525 SB



Standard Equipment

- 1 Magnetic drilling machine
- 1 Quick-change arbor system
KEYLESS Weldon 3/4"
- 1 Manual arbor with set screws,
Weldon 3/4", MT3
- 1 Geared chuck, 3/4"
- 2 Pilot pins - 1" and 2" depth
- 1 Safety chain
- 1 Drift key MT3
- Tap collet adapters - 1/4", 3/8", 1/2" and 3/4"
- 1 Warranty certificate

Standard Equipment

also includes
molded plastic
carrying case,
operating manual,
auto lubrication,
safety strap,
carabin hook and
allen keys.

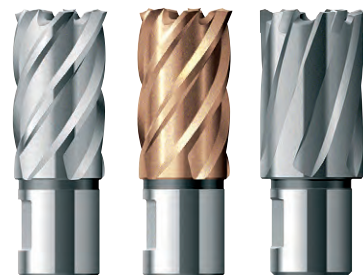

See pages 56-61 for our HSS, TiAIN
and Carbide-tipped cutters.



➤ Annular Cutters: pages 54-64 ➤ Accessories: pages 65-71

MAB 825 KTS



Versatile machine with adjustable X and Y positioning

Powerful • Reliable

- 16 Amp double-insulated motor
- 4-speed oilbath gearbox for applications requiring high power
- Designed for continuous use
- Infinitely variable torque control and full-wave control electronics
- Ideal for drilling, boring and slotting applications
- Includes servo-assisted drilling feature to help maintain feed pressure during operation

**Drill up to 3-1/8" dia.
Tap up to 1-3/16" dia.**





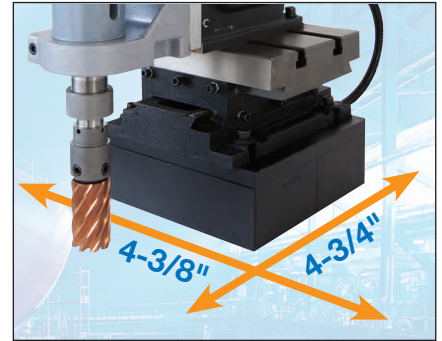

- Multi-axis positioning
- Uses annular cutters up to 3-1/8" dia.
- Twist drilling capacity up to 1-1/4" dia.
- 10" stroke
- Integrated cutting oil reservoir
- Automatic internal lubrication

Integrated Safety

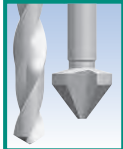
- Simple, ergonomic arrangement of controls for one-handed operation
- Emergency-off function

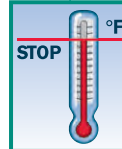

Model MAB 825 KTS features multi-axis positioning, allowing the drill to be adjusted up to 4-3/4" forward/backward and up to 4-3/8" left/right after magnet is adhered to surface. Ideal for job site drilling, boring and slotting applications where dismantling is not feasible.

Cutter Capacity	Twist Drill / Countersink	Ream / Tap	Stroke (length)	4-gear Variable Speed (RPM)	Electronics	Overheat Protection	Magnet Force Indicator	Reversible (CW/CCW)
 Ø 3 1/8"	 Ø 1 1/4" / 1 37/64"	 Ø 1 1/4" / Ø 1 1/4"	 10"	 40-110, 65-175, 140-360, 220-600	 Variable-speed Control	 CoolMag™	 SafeMag™	

➤ *Annular Cutters: pages 54-64* ➤ *Accessories: pages 65-71*

MAB 825 KTS

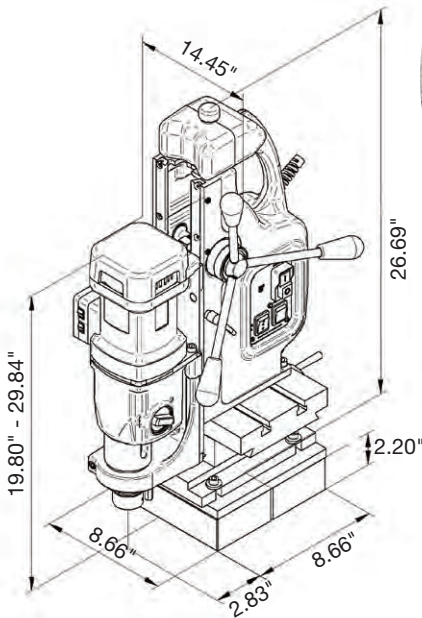
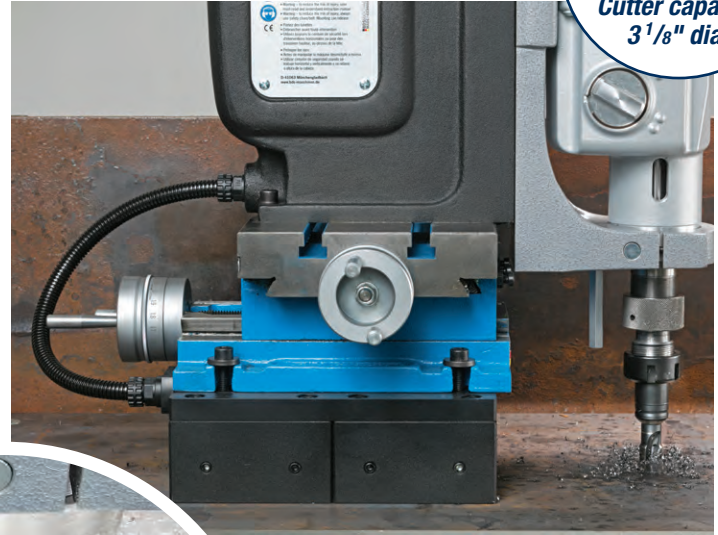

Chuck Collet Tool Holder Set with Case

Part No. ZSF 316 (included) can hold most standard end mills with shanks from 1/8" to 5/8" dia. (3mm to 16mm dia.). Kit includes:

- MT3 collet holder with threaded adapter piece
- 15 collets for shank diameters 1/8" to 5/8" (3 to 16mm)
- 2 collet tightening spanner wrenches



Model MAB 825 KTS Specifications

Motor Power	16 Amp / 110 Volt
Weight	99 lbs.
Hole Capacity	3 1/8" dia.
Twist Drill Capacity	1 1/4" dia.
Tapping Capacity	1 3/16" dia.
Speed	40-110, 65-175 140-360, 220-600 RPM
Magnet Base Size	8 11/16" L x 8 11/16" W
Dimensions	19 3/4" H x 13" L x 14 1/2" W
Magnetic Force (1" plate)	6600 lbs.
Arbor Bore	3/4" and 1 1/4", standard
Spindle	MT3
Automatic Lubrication	Included



Standard Equipment

- 1 Magnetic drilling machine
- 1 Chuck collet tool holder set
- 1 Steel carrying case†
- 1 Safety chain
- 1 Operating manual
- 1 Warranty certificate

Standard Equipment also includes auto lubrication, safety strap, carabin hook and allen keys.

† Steel case intended mainly for shipping purposes; damage may occur in transit.

Optional 3/4" geared chucks available (Part No. IBC 21)

➤ [Annular Cutters: pages 54-64](#) ➤ [Accessories: pages 65-71](#)

MAB 825 & MAB 845

Cutter capacity
4 1/16" dia.

Ideal for steel engineering, plant construction and more



REVERSIBLE

Powerful • Reliable

- 16 Amp double-insulated motor
- 4-speed oilbath gearbox for applications requiring high power
- Designed for continuous use
- Infinitely variable torque control and full-wave control electronics

**Drill up to 4-1/16" dia.
Tap up to 1-1/8" dia.**

- Uses annular cutters up to 4-1/16" dia.
- Twist drilling and reaming capacities up to 1-1/4" dia.
- Tapping capacity up to 1-1/8" dia.
- Integrated cutting oil reservoir
- Automatic internal lubrication
- Automatic feed (model MAB 825 V), ideal for production applications
- Swivel base (model MAB 845)

Keyless Cutter Mount

- Quick-change keyless cutter system for 3/4" Weldon shank
- Arbor for 1-1/4" Weldon shank
- Also includes manual arbor for 3/4" Weldon shank (MT3) with set screws

Integrated Safety

- Green/Red LED magnetic force indicator for safe operation
- Internal cable routing
- Simple, ergonomic arrangement of controls for one-handed operation
- Emergency-off function



Internal cable routing protects the motor power cord from external damage

Equipped with Electronic Safety Shutoff Sensor (see p. 25)

4 Gears with Variable Speed



Twist Drilling



Tapping



Reaming



Countersinking

MAB 825

Standard model with 16 Amp motor

MAB 825 V

Includes automatic feed - ideal for production applications

MAB 845

Includes 30° movement left and right and 3/4" forward and backward

See pages 49 and 68 for Tap Holders and Accessories

Cutter Capacity

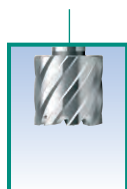

ø 4 1/16"

Twist Drill / Countersink

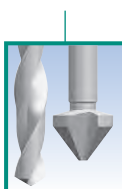

ø 1 1/4" / ø 2"

Ream / Tap

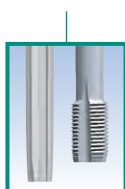

ø 1 1/4" / ø 1 1/8"

Stroke (length)

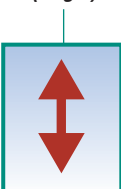

10"

4-gear Variable Speed (RPM)



40-110
65-175
140-360
220-600

Electronics



Variable-speed Control

Overheat Protection

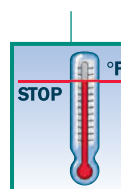

CoolMag™

Magnet Force Indicator



SafeMag™

Reversible (CW/CCW)



➤ Annular Cutters: pages 54-64 ➤ Accessories: pages 65-71

MAB 825 & MAB 845 Specifications

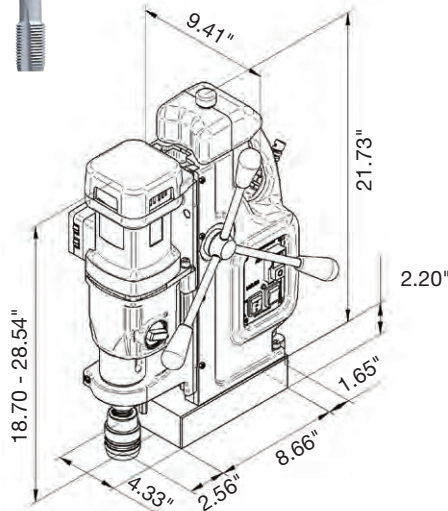

Model MAB 825, 825 V & 845



With an optional 3/4" geared chuck (Part No. IBC 21), this model easily converts to a standard drill press for conventional twist drills.



Model MAB 825 & 845 Specifications

Motor Power	16 Amp / 110 Volt
Weight	55 lbs.
Hole Capacity	4 ¹ / ₁₆ " dia.
Twist Drill Capacity	1 ¹ / ₄ " dia.
Tapping Capacity	1 ¹ / ₈ " dia.
Speed	40-110, 65-175, 140-360, 220-600 RPM
Magnet Base Size	8 ⁵ / ₈ " L x 4 ¹ / ₃ " W
Dimensions	18 ⁵ / ₈ " H x 14 ⁷ / ₁₆ " L x 9 ⁷ / ₁₆ " W
Magnetic Force (1" plate)	6600 lbs.
Arbor Bore	3/4" and 1 ¹ / ₄ ", standard
Spindle	MT3
Automatic Lubrication	Included
Automatic Feed	Order MAB 825 V
Swivel Base	Order MAB 845

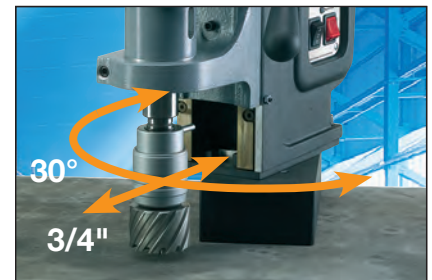

Model MAB 845 features a swivel base providing 30° movement left and right and 3/4" forward and backward.

Standard Equipment

- 1 Magnetic drilling machine
- 1 Quick-change arbor system KEYLESS Weldon 3/4"
- 1 Manual arbor with set screws, Weldon 3/4", MT3
- 1 Arbor 1¹/₄" Weldon, MT3*
- 4 Pilot pins - 1", 2", 3" and 4" depth
- 1 Safety chain
- 1 Hexagon socket screw key SW 6
- 1 Drift key MT3
- 1 Warranty certificate
- 1 Carrying case**



Standard Equipment also includes operating manual, auto lubrication, safety strap, carabin hook and allen keys.

* Optional accessory for MAB 825 V
** Not available for MAB 825 V

Rolling Transport Case

Robust transport case with wheels, carrying handle and sturdy closures. Included with MAB 825/845 – protect your drill from water and dust with this rugged case. (Part No. ZHK 825)



➤ Annular Cutters: pages 54-64 ➤ Accessories: pages 65-71



MAB 1300

Large holes – up to 5 1/8" diameter
Tapping up to 1 5/8" diameter



4 Gears with Variable Speed



Twist Drilling



Tapping



Reaming



Countersinking



Optional Special-Purpose Cutting Tool

Powerful • Reliable

- 20 Amp double-insulated motor
- 22" high, 112 lbs.
- 4-speed oilbath gearbox for applications requiring high power
- Designed for continuous use
- Infinitely variable torque control and full-wave control electronics

Drill up to 5-1/8" dia.
Tap up to 1-5/8" dia.

- Uses annular cutters 7/16" to 5-1/8" dia., 1" and 2" depth 7/16" to 5-1/8" dia., 3" to 8" depth*
- Twist drilling up to 1-3/4" - uses MT4, countersinking up to 3" dia.
- Tapping up to 1-5/8"
- Reaming up to 2"
- Automatic internal lubrication

Integrated Safety

- Green/Red LED magnetic force indicator for safe operation
- Equipped with Electronic Safety Shutoff Sensor
- Emergency-off function







Ideal for use with TCT Carbide cutters up to 5 1/8" dia. – see pages 60-61.



* 3" depth cutters or longer require purchase of ZIA 432 KN adapter.

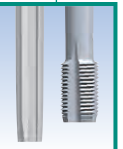
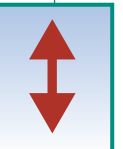

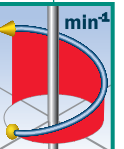
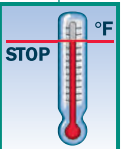
Equipped with Electronic Safety Shutoff Sensor
 (see p. 25)

Cutter Capacity	Twist Drill / Countersink	Ream / Tap	Stroke (length)	4-gear Variable Speed (RPM)	Electronics	Overheat Protection	Magnet Force Indicator	Reversible (CW/CCW)
 ø 5 1/8"	 ø 1 3/4" / ø 3"	 ø 2" / ø 1 5/8"	 3.35" (12" without retainer)	 30-80 50-120 130-350 210-550	 Variable-speed Control	 CoolMag™	 SafeMag™	

➤ *Annular Cutters: pages 54-64* ➤ *Accessories: pages 65-71*

MAB 1300 Specifications

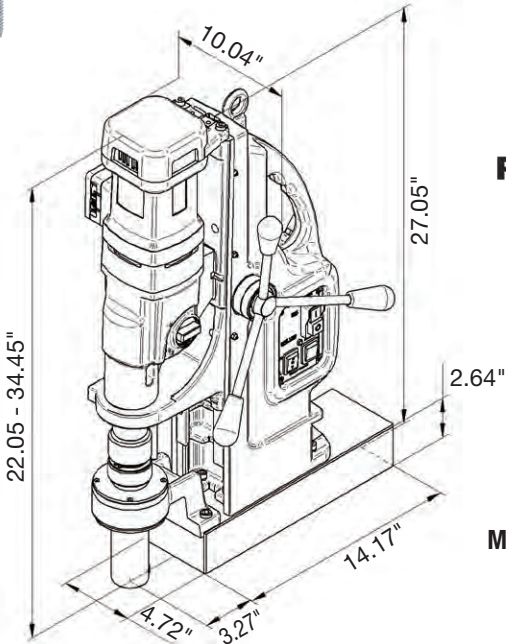

Model MAB 1300



Model MAB 1300 Specifications

Motor Power	20 Amp / 110 Volt
Weight	112 lbs.
Hole Capacity	5 1/8" dia.**
Twist Drill Capacity	1 3/4" dia.
Tapping Capacity	1 5/8" dia.
Speed	30-80, 50-120, 130-350, 210-550 RPM
Magnet Base Size	14" L x 4 3/4" W
Dimensions	22" H x 19 1/2" L x 10" W
Magnetic Force (1" plate)	23,600 lbs.
Arbor Bore	1 1/4" (3/4" adapter included)
Spindle	MT4
Automatic Lubrication	Included



** Maximum hole diameter is with TCT Carbide cutters - see p. 60-61

Standard Equipment

- 1 Magnetic drilling machine
- 1 Carrying case on wheels
- 1 Arbor adapter to 3/4" Weldon
- 1 Safety chain
- 1 Hexagon socket screw key SW 6
- 1 Drift key MT4
- 1 Operating manual
- 1 Warranty certificate



Standard Equipment also includes auto lubrication, safety strap, carabin hook and allen keys.



Accessories

See pages 48-49 for tapping accessories and wheeled carrying case.

ZHK 1300 wheeled carrying case included with MAB 1300

➤ Annular Cutters: pages 54-64 ➤ Accessories: pages 65-71



MAB 1300 V

Strongest magnetic drill with adjustable automatic feed and reverse

- Ideal for production applications
- Power feed controls drill pressure to maintain optimal RPM and feed rate

Drill up to 5-1/8" dia.
Tap up to 1-5/8" dia.
Ream up to 2" dia.



Drill automatically



Drill manually

Automatic feed motor

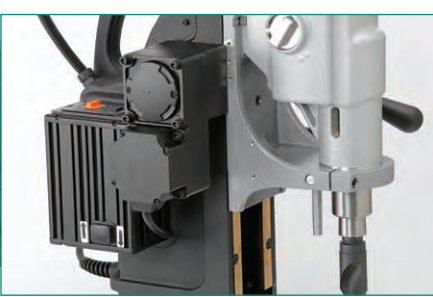

Rolling Transport Case for MAB 1300



Order No. **ZHK 1300**

Robust transport case with wheels, carrying handle and sturdy closures. Protect your investment from water and dust with this rugged case. Four large ABS locks and an interior configuration customized for machine to secure drill and accessories during transit. Lightweight, heavy-duty plastic construction and robust ABS wheels.

Drill not included with ZHK 1300. Purchase of MAB 1300 drill includes ZHK 1300 case. See page 45 for MAB 825/845 case.



Watertight, shock-proof and robust – the right protection for your machine.

Four large ABS locks secure the robust plastic case

Tapping Accessories for MAB 1300, MAB 825, MAB 845 and CSU 100/3RL



Heavy-duty Tap Holders

- Positive, accurate driving of larger-sized taps
- No slippage or tap damage
- Tap shank square engages with square drive socket
- 3 set screws secure tap in holder

Order Number	Morse Taper	Tap Size	Tap Shank Diameter	Tap Shank Square
70308	3	5/8"	.480	.366
70301	3	3/4"	.590	.442
70302	3	7/8"	.697	.523
70303	3	1"	.800	.600
70304	3	1-1/8"	.896	.672
70305	3	1-1/4"	1.02	.765
70307	3	1-1/2"	1.23	.925
70401	4	3/4"	.590	.442
70402	4	7/8"	.697	.523
70403	4	1"	.800	.600
70404	4	1-1/8"	.896	.672
70405	4	1-1/4"	1.021	.766
70406	4	1-3/8"	1.108	.831
70407	4	1-1/2"	1.233	.925
70408	4	1-5/8"	1.305	.979



Part No. **GSW 444** quick-change tapping chuck with MT4 connection (for MAB 1300). Collets not included. *GSW 444 and GSS.4xx collet set shown below.*

Order Number	Tap Collet	Shank Diameter	Square Drive
GSS.420	20mm	16mm	12mm
GSS.422	22mm	18mm	14.5mm
GSS.427	27mm	20mm	16mm
GSS.433	33mm	32mm	20mm
GSS.442	42mm	32mm	24mm



See page 68 for additional tapping options.



Tap Collets and Reducing Adapters

Tap Collets with 3/4" or 1-1/4" Weldon shank <i>all threads shown are ASA Standard (or DIN 376 for metric)</i>			
Thread	Order No.	Thread	Order No.
1/4	TCM 1/4	10mm	ZGA 010
5/16	TCM 5/16	12mm	ZGA 012
3/8	TCM 3/8	14mm	ZGA 014
7/16	TCM 7/16	16mm	ZGA 016
1/2	TCM 1/2	18mm	ZGA 018
9/16	TCM 9/16	20mm	ZGA 020
5/8	TCM 5/8	22mm	ZGA 022
11/16	TCM 11/16	24mm	ZGA 024
3/4	TCM 3/4	27mm	ZGA 027
1-1/4" Weldon shank:		1-1/4" Weldon shank:	
1	TCM 1	33mm	ZGA 033
1-1/4	TCM 1-1/4	42mm	ZGA 044

Bushing – Reduces 1-1/4" Weldon shank to 3/4" Weldon shank
Order No. **ZAP 200**



Reducing Sleeves
DIN 2185



Order No. **ZRH 320** for MT 3:2
(adapts MT3 to MT2)

Order No. **ZRH 430** for MT 4:3
(adapts MT4 to MT3)

Unibroach® Large-Hole Cutting

Cut holes up to 5-1/8" dia., 12" deep!

Available in TCT Carbide, HSS, Cobalt and ARMOR-PLATED Unibroach™



Drill perfect holes up to 5 1/8" diameter without runout

- Standard with 3/4" or 1 1/4" shank diameters
- More cutting teeth to distribute the load evenly – increase tool life and achieve faster feed rates
- Use on milling machines, drill presses, CNC and other equipment
- A solid slug has a higher value for scrap metal

* Pilot pins supplied with annular cutters up to 4" DOC. Other pilot pins can be purchased separately.

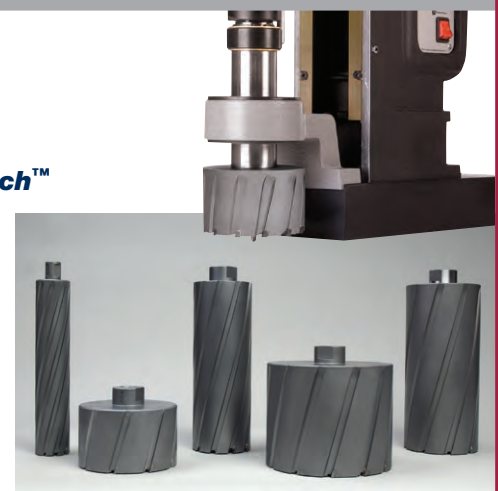



AIRBOR™ AB-4300

Motor and magnet are powered completely by compressed air

Pneumatic power for hazardous environments

ATEX Certified

Safe • Reliable

- Inherently safer than electromagnetic drills in hazardous atmospheres and wet environments where electricity requires "hot work permits"
- ATEX certified
- Industry's first completely air-operated magnetic drill – NO ELECTRICITY!
- Fail-safe permanent magnet is activated "on" and "off" by air pressure; in the event of a loss of air flow, the magnet will not disengage
- 1600 lbs. magnet holding strength

Drill up to 2-1/16" dia.

- Uses annular cutters up to 2-1/16" dia.
- Twist drilling capacity up to 5/8" dia.
- Powerful 1.6 HP drill motor
- Long drill stroke – up to 10 1/4"
- Pressurized coolant system lubricates cutter and reduces risk of sparking

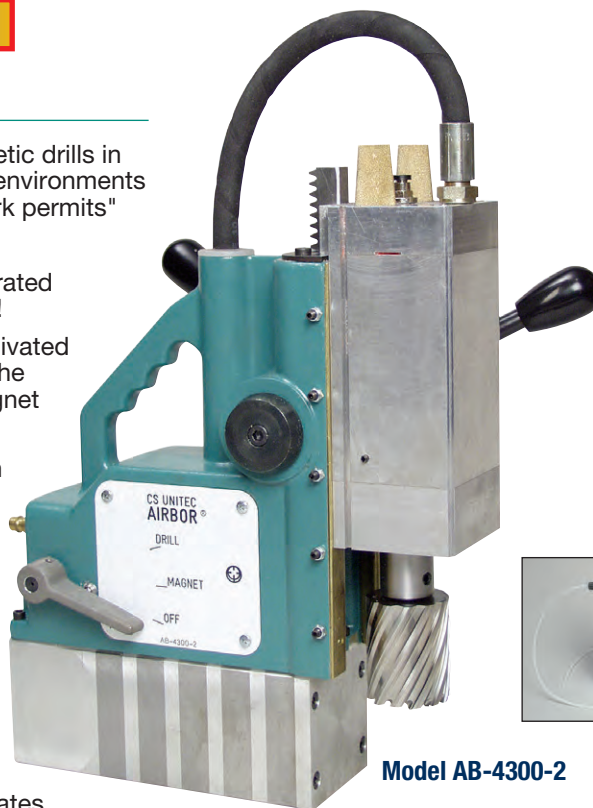

Model AB-4300-2



With a geared chuck adapter (Part No. IBC 18) and extra rack (Model No. AB-4300-2R), AIRBOR™ easily converts to a standard drill press with a 7 1/2" stroke.



Pressurized lubrication system (Part No. 9 4002 0020 N)



AB-4300-2R shown with extra rack up (left) and extra rack down (right).

Cutter Capacity

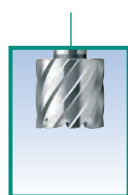

ø 2 1/16"

Twist Drill / Countersink

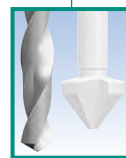

5/8"

Stroke (length)

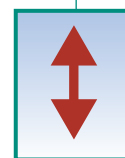

Up to 10 1/4"

Speed Range (RPM)



400

Model AB-4300-2 / AB-4300-2R Specifications

Motor Power (Pneumatic)	1.6 HP
Air Consumption @ 90 PSI	64 CFM (1/2" NPT Air Connection)
Hole Capacity	2 1/16" dia.
No Load Speed	400 RPM
Magnet Base Size	8 3/4" L x 3 1/2" W
Dimensions	13 1/2" H x 12 1/2" L x 4 3/4" W
Magnetic Force (1" plate)	1600 lbs.
Arbor Bore	3/4" Weldon Shank
Automatic Lubrication	Included
Stroke Length 4 7/8"	Order Model AB-4300-2
Stroke Length 10 1/4"	Order Model AB-4300-2R

Model Comparison

AB-4300-2R **AB-4300-2**

Drill Stroke			
w/cutters	w/chuck	w/cutters	w/chuck
10 1/4"	7 1/2"	4 7/8"	1 3/4"
Height			
closed	open	closed	open
13 1/2"	22"	13 1/2"	17 1/2"
Weight			
43 lbs.	20 kg	38 lbs.	18 kg

➤ Annular Cutters: pages 54-64 ➤ Accessories: pages 65-71

HB 4400 for Subsea Drilling

Hydraulic for marine and construction – works underwater



Safe • Reliable

- Ideal for industrial, construction, marine and mining applications
- Drill structural steel and other metals
- Hydraulic motor safe for underwater use
- Manually operated permanent magnet with ratchet control has holding strength of 1300 lbs.





Drill up to 2-1/16" dia.

- Uses annular cutters up to 2-1/16" dia.
- Twist drilling capacity up to 1/2" dia.
- Automatic lubrication



With a 3/4" chuck (Part No. 602045A), this model easily converts to a standard drill press with a 3" stroke.

Model HB 4400
Hoses not included

Cutter Capacity	Twist Drill	Stroke (length)	Speed Range (RPM)
			
Ø 2 1/16"	1/2"	Up to 3 3/4"	0-630



Model HB 4400 Specifications

Motor Power (Hydraulic)	1.5 HP
Weight	48 1/2 lbs.
Hole Capacity	2 1/16" dia.
Twist Drill Capacity	1/2" dia.
No Load Speed, Variable	0-630 RPM
Hydraulic Supply	Flow 6.5 GPM @ 2000 PSI
Magnet Base Size	7 1/4" L x 3" W
Dimensions	18 1/2" H x 12 1/2" L x 7" W
Magnetic Force (1" plate)	1300 lbs.
Automatic Lubrication	Included



➤ [Annular Cutters: pages 54-64](#) ➤ [Accessories: pages 65-71](#)



Cutter capacity
4" dia.

Model 2 1345 0010 – Hydraulic

Ideal for use in Ex Zones and subsea applications

ATEX Certified

Safe • Reliable

- Hydraulic motor safe for underwater use
- Ideal for industrial, construction, marine and mining applications
- ATEX Certified EX II 2Gc IIB T5
- Drill structural steel and other metals
- Manually operated permanent magnet with lever control has holding strength of 1874 lbs.

Drill up to 4" dia.

- Uses annular cutters up to 4" dia.
- Twist drilling capacity up to 1-1/4" dia.
- Tapping capacity up to 1" dia.



Model 2 1345 0010 Specifications

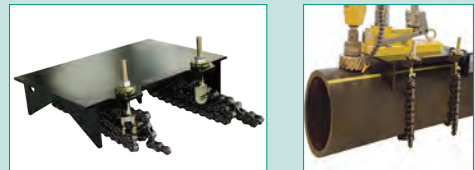

Motor Power (Hydraulic)	3.4 HP
Weight	50 lbs.
Hole Capacity	4" dia.
Twist Drill Capacity	1 1/4" dia.
No Load Speed, Variable	40-250 RPM
Hydraulic Supply	Flow 5.3 GPM @ 2000 PSI
Magnet Base Size	11 ^{11/16} " L x 4" W
Dimensions	21 ^{1/2} " H x 15 ^{7/16} " L x 7 ^{3/4} " W
Magnetic Force (3/8" plate)	1874 lbs.
Spindle	MT3
Larger Magnet	Order Model 2 1345 0020 12.835" x 7.480" magnet 3,307 lbs. magnetic force

Pipe Clamp – Model 2 1330 8500

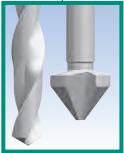
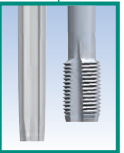
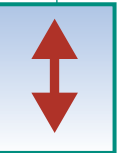

Optional clamp allows right angle drilling of steel, cast iron, cement and plastic pipes up to 19-1/2" dia.

Extension chains available for pipes up to 43-1/4" dia.
P/N 5 1201 9030* – For pipes up to 31-1/2" (800mm)
P/N 5 1201 9020* – For pipes up to 43-1/4" (1100mm)
* 2 pieces needed for one clamp

Cutter Capacity	Twist Drill / Countersink	Ream / Tap	Stroke (length)	Variable Speed (RPM)	Reversible (CW/CCW)
 ø 4"	 ø 1 1/4" / ø 2"	 ø 1 1/8" / ø 1"	 12"	 40-250	

Standard Equipment includes hydraulic hose set, coolant bottle, arbor adapter to 3/4" Weldon, arbor adapter to 1-1/4" Weldon, safety chain, drift key, allen keys and carrying case.

➤ Annular Cutters: pages 54-64 ➤ Accessories: pages 65-71

Underwater Tools

Hydraulic- and air-powered tools for use in subsea applications

Grinders - Hydraulic

- 1 1580 0060 N Underwater Hydraulic Horizontal Grinder, 1.3HP, 7000 RPM, Twist throttle, straight grinding wheels
- 1 1585 0010 Underwater Hydraulic Angle Grinder, 1.3HP, 5500 RPM, Lever throttle, grinding wheels up to 7"
- 1 5080 0020 Underwater Hydraulic Peanut Die Grinder, 1.0 HP, 11,500 RPM, Lever throttle, 1/4" collet
- 1 2060 0010 Underwater Hydraulic Vertical Grinder, 4.75 HP, 3600 RPM, grinding wheels up to 9"

Rotary Hammer Drills - Hydraulic and Pneumatic

- 2 2404 0030 Underwater Air Rotary Hammer Drill, SDS Plus, 1" cap. in concrete, 0-3000 BPM, .5 HP, 90 PSI / 21 CFM
- 2 2417 0010 Underwater Air Rotary Hammer Drill, SDS Max, 2" cap. in concrete, 0-2500 BPM, 1.2 HP, 90 PSI / 21 CFM
- 2 2426 0010 Underwater Hydraulic Rotary Hammer Drill, SDS Plus, 1" cap. in concrete, 0-3400 BPM, .8 HP; includes built-in pressure reducing valve
- 2 2418 0020 Underwater Hydraulic Rotary Hammer Drill, SDS Max, 2" cap. in concrete, 2500 BPM, 1.75 HP, includes pressure reducing valve

Core Drills - Hydraulic and Pneumatic

- 2 1317 0030 Underwater Hydraulic Core Drill, 3" max. dia., 3.6 HP, 380/900/1800 RPM
- 2 1335 0010 Underwater Pneumatic Core Drill, 3" max. dia., 3.8 HP, 300/700/1350 RPM

Impact Wrenches - Hydraulic and Pneumatic

- 6 1316 0070 3/4" Air Impact Wrench, 1-1/8" (M 30) max. bolt size, 995 ft-lbs. torque
- 6 1316 0060 1" Air Impact Wrench, 1-1/8" (M 30) max. bolt size, 995 ft-lbs. torque
- 6 1515 0010 3/4" Hydraulic Impact Wrench, 1" (M 27) max. bolt size, 1220 ft-lbs. torque
- 6 1520 0010 1" Hydraulic Impact Wrench, 1-3/8" (M 36) max. bolt size, 1840 ft-lbs. torque



Caution: User must follow all appropriate safety regulations when choosing a tool for their particular working environment.

Other Underwater Tools Available:

Woodboring Drills - Pneumatic See page 79

Reciprocating Saws - Hydraulic and Air See page 120-121

Hacksaws - Hydraulic See page 124-125

Chain Saws - Air and Hydraulic



Annular Cutters

Achieve burr-free finished holes, without predrilling or stepdrilling

ANNULAR CUTTERS

Precision-ground flutes provide efficient chip clearance, increasing drilling productivity and decreasing cutter breakage

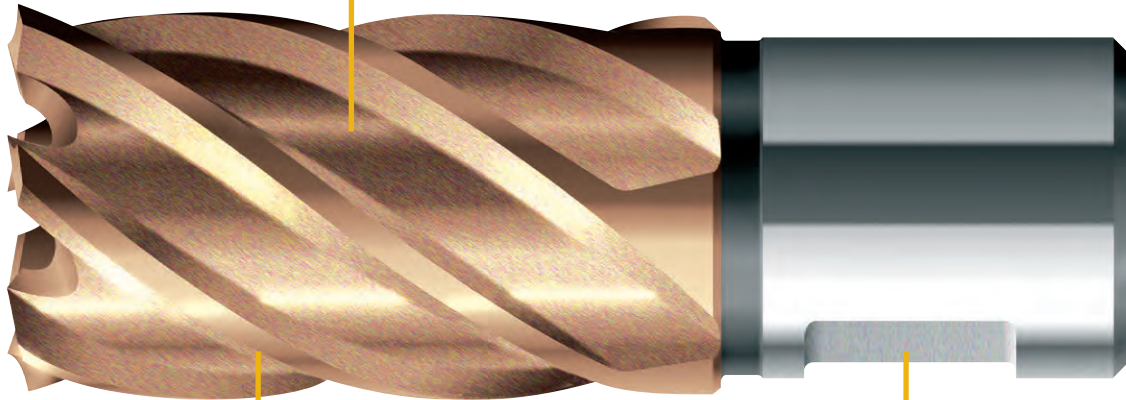

Hardened, high-speed tool steel

Weldon Shank

Benefits of CS Unitec's Cutter Design:

Double-action tooth geometry cuts, splits and ejects chips more efficiently,

- increasing cutting speed
- reducing tooth load
- minimizing tool wear
- lengthening cutter life

Engineered with a tapered inner wall for smooth, easy slug ejection.

Center hole for pilot pin accurately aligns the cutter, allows for internal lubrication and removes the slug.



Perfect drilling to close tolerances without runout.
The result: a burr-free finished hole.



Pilot Pins: How they work...



Pilot Pin included with every annular cutter up to 4" DOC

1: Centering

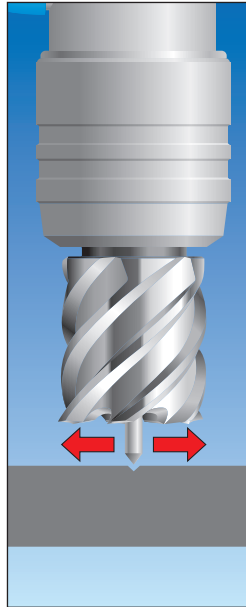

The pilot pin accurately centers cutter over area to be drilled.

2: Oiling

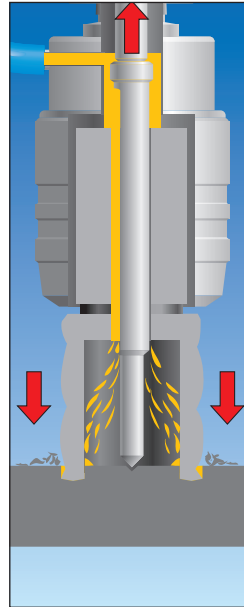

During drilling, the pilot pin retracts and allows internal coolant to reach the cutting teeth.

3: Ejecting

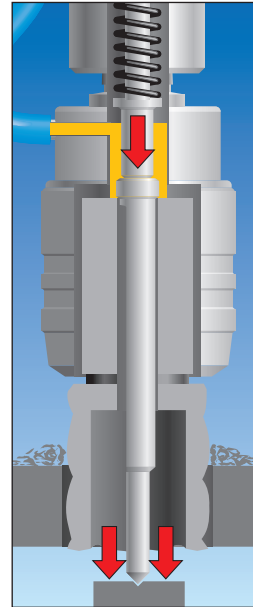

When hole is complete, the slug is automatically ejected from the cutter.

6-Series HSS Unibroach™ Annular Cutters – Pages 56-57

Fully ground HSS annular cutters

Cutting depth:	1"	2"	3"	4"	6"	8"	
Drilling ø:	7/16" - 5-1/8"	7/16" - 5-1/8"	3/4" - 5-1/8"	3/4" - 6"	3/4" - 6"	3/4" - 6"	

8-Series ARMOR-PLATED Unibroach™ Annular Cutters – Pages 58-59

Fully ground HSS annular cutters with TiAlN hard coating

Cutting depth:	1"	2"	3"			
Drilling ø:	7/16" - 5-1/8"	7/16" - 5-1/8"	3/4" - 5-1/8"			

9-Series Unibroach™ TCT Hornet Annular Cutters – Pages 60-61

Sintered carbide annular cutters with Tungsten Carbide tips

Cutting depth:	1"*	2-3/8"	3-3/8"	4"	6"	8"	
Drilling ø:	1/2" - 2"	1/2" - 5-1/8"	3/4" - 5-1/8"	3/4" - 6"	3/4" - 6"	3/4" - 6"	

* 1-3/8" depth for diameters larger than 1-1/2"

For Cobalt Cutters, Rail Cutters and special sizes, see page 63. For One-Touch TCT Cutters, see page 62.



➤ See pages 65-71 for Drill Accessories

Unibroach® Annular Cutters

High-speed steel for drilling 3x faster than twist drills



**Annular Cutter
Recommended
Revolutions Per Minute**
Recommended Feed Rate:
.002 - .004 inches per revolution

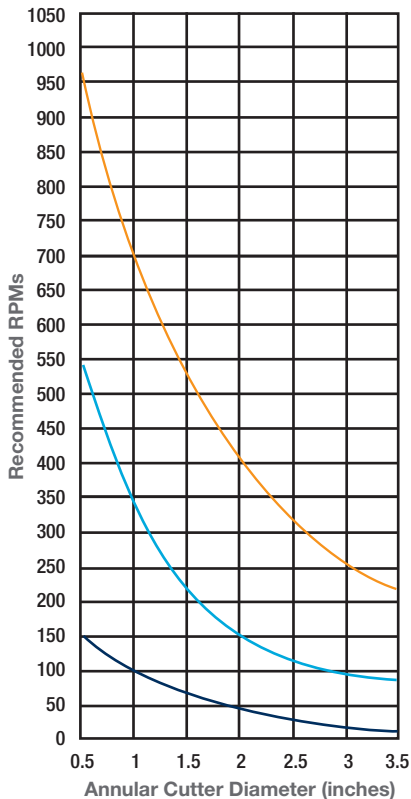

Annular Cutters are the standard hole-making drills in the industry. Ideal for heavy-duty use on-site or in the shop, our HSS Unibroach™ cutters are available in the following sizes:

Drill Depth	1"	2"	3"	4"	6"	8"
Diameter	Ø 7/16" to Ø 5 1/8"	Ø 7/16" to Ø 5 1/8"	Ø 3/4" to Ø 5 1/8"	Ø 3/4" to Ø 6"	Ø 3/4" to Ø 6"	Ø 3/4" to Ø 6"

Special sizes available; metric cutters available on request.
Every annular cutter up to 4" DOC includes a pilot pin.*

- CNC precision ground for fast penetration, accuracy and long life
- Flutes run the length of the cutter for efficient chip clearance, increased drilling productivity and decreased cutter breakage
- Drill holes 3 times faster than twist drills
- Produce reamed-quality, burr-free holes and solid slugs
- Reduce machine size and weight
- Cutting edges are resharpenable
- Eliminate time-consuming, costly pilot holes and step drilling

HSS Cutters must be used with lubricant.
See page 66 for CS Unitec lubricants and cutting oil.



See page 65 for HSS
Annular Cutter Starter Kit.



* Pilot pins supplied with annular cutters up to 4" DOC.
Other pilot pins can be purchased separately.

Unibroach® Stack Cutters are available in diameters from 9/16" to 1 1/8" in 1", 2" and 3" depths. Drill multiple layers of steel without stopping to remove the center slug. Please contact us or consult our price list for more information.

6-Series HSS

1" Depth

Order No.	Diameter
6-1-114	7/16"
6-1-116	1/2"
6-1-118	9/16"
6-1-120	5/8"
6-1-122	11/16"
6-1-124	3/4"
6-1-126	13/16"
6-1-128	7/8"
6-1-130	15/16"
6-1-132	1"
6-1-134	1-1/16"
6-1-136	1-1/8"
6-1-138	1-3/16"
6-1-140	1-1/4"
6-1-142	1-5/16"
6-1-144	1-3/8"
6-1-146	1-7/16"
6-1-148	1-1/2"
6-1-150	1-9/16"
6-1-152	1-5/8"
6-1-154	1-11/16"
6-1-156	1-3/4"
6-1-158	1-13/16"
6-1-160	1-7/8"
6-1-162	1-15/16"
6-1-164	2"
6-1-166	2-1/16"
6-1-168	2-1/8"
6-1-170	2-3/16"
6-1-172	2-1/4"
6-1-174	2-5/16"
6-1-176	2-3/8"
6-1-178	2-7/16"
6-1-180	2-1/2"
6-1-182	2-9/16"
6-1-184	2-5/8"
6-1-186	2-11/16"
6-1-188	2-3/4"
6-1-190	2-13/16"
6-1-192	2-7/8"
6-1-194	2-15/16"
6-1-196	3"
6-1-198	3-1/16"
6-1-1100	3-1/8"
6-1-1102	3-3/16"
6-1-1104	3-1/4"
6-1-1106	3-5/16"
6-1-1108	3-3/8"
6-1-1110	3-7/16"
6-1-1112	3-1/2"
6-1-1114	3-9/16"
6-1-1116	3-5/8"
6-1-1118	3-11/16"
6-1-1120	3-3/4"
6-1-1122	3-13/16"
6-1-1124	3-7/8"
6-1-1126	3-15/16"
6-1-1128	4"

2" Depth

Order No.	Diameter
6-1-214	7/16"
6-1-216	1/2"
6-1-218	9/16"
6-1-220	5/8"
6-1-222	11/16"
6-1-224	3/4"
6-1-226	13/16"
6-1-228	7/8"
6-1-230	15/16"
6-1-232	1"
6-1-234	1-1/16"
6-1-236	1-1/8"
6-1-238	1-3/16"
6-1-240	1-1/4"
6-1-242	1-5/16"
6-1-244	1-3/8"
6-1-246	1-7/16"
6-1-248	1-1/2"
6-1-250	1-9/16"
6-1-252	1-5/8"
6-1-254	1-11/16"
6-1-256	1-3/4"
6-1-258	1-13/16"
6-1-260	1-7/8"
6-1-262	1-15/16"
6-1-264	2"
6-1-266	2-1/16"
6-1-268	2-1/8"
6-1-270	2-3/16"
6-1-272	2-1/4"
6-1-274	2-5/16"
6-1-276	2-3/8"
6-1-278	2-7/16"
6-1-280	2-1/2"
6-1-282	2-9/16"
6-1-284	2-5/8"
6-1-286	2-11/16"
6-1-288	2-3/4"
6-1-290	2-13/16"
6-1-292	2-7/8"
6-1-294	2-15/16"
6-1-296	3"
6-1-298	3-1/16"
6-1-2100	3-1/8"
6-1-2102	3-3/16"
6-1-2104	3-1/4"
6-1-2106	3-5/16"
6-1-2108	3-3/8"
6-1-2110	3-7/16"
6-1-2112	3-1/2"
6-1-2114	3-9/16"
6-1-2116	3-5/8"
6-1-2118	3-11/16"
6-1-2120	3-3/4"
6-1-2122	3-13/16"
6-1-2124	3-7/8"
6-1-2126	3-15/16"
6-1-2128	4"

3" Depth*

Order No.	Diameter
N/A	
N/A	
N/A	
N/A	
6-1-322	11/16"
6-1-324	3/4"
6-1-326	13/16"
6-1-328	7/8"
6-1-330	15/16"
6-1-332	1"
6-1-334	1-1/16"
6-1-336	1-1/8"
6-1-338	1-3/16"
6-1-340	1-1/4"
6-1-342	1-5/16"
6-1-344	1-3/8"
6-1-346	1-7/16"
6-1-348	1-1/2"
6-1-350	1-9/16"
6-1-352	1-5/8"
6-1-354	1-11/16"
6-1-356	1-3/4"
6-1-358	1-13/16"
6-1-360	1-7/8"
6-1-362	1-15/16"
6-1-364	2"
6-1-366	2-1/16"
6-1-368	2-1/8"
6-1-370	2-3/16"
6-1-372	2-1/4"
6-1-374	2-5/16"
6-1-376	2-3/8"
6-1-378	2-7/16"
6-1-380	2-1/2"
6-1-382	2-9/16"
6-1-384	2-5/8"
6-1-386	2-11/16"
6-1-388	2-3/4"
6-1-390	2-13/16"
6-1-392	2-7/8"
6-1-394	2-15/16"
6-1-396	3"
6-1-398	3-1/16"
6-1-3100	3-1/8"
6-1-3102	3-3/16"
6-1-3104	3-1/4"
6-1-3106	3-5/16"
6-1-3108	3-3/8"
6-1-3110	3-7/16"
6-1-3112	3-1/2"
6-1-3114	3-9/16"
6-1-3116	3-5/8"
6-1-3118	3-11/16"
6-1-3120	3-3/4"
6-1-3122	3-13/16"
6-1-3124	3-7/8"
6-1-3126	3-15/16"
6-1-3128	4"

* Cutters with 3" depth have an 8mm pilot hole.

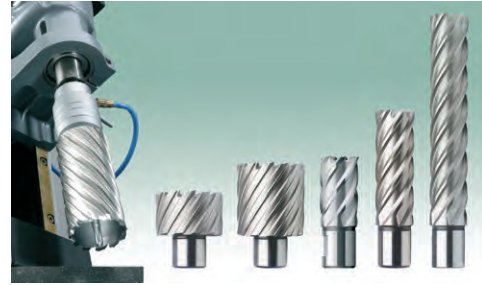

Shank size:

**3/4" for cutters up to 3" dia.
1-1/4" for cutters 3-1/16 to 5-1/8" dia.**

Pilot pin included with every annular cutter up to 4" DOC

Cutter Kits

Each HSS steel cutter kit comes with the following: 9/16", 11/16", 13/16", 15/16", 1-1/16", pilot pins & carrying case.

Order No.	Description
6-1-001	1" depth Cutter Kit
6-1-002	2" depth Cutter Kit

Pilot Pins for 6-Series

Order No.	Description
For 3/4" Shanks	
7-3-102	7/16" - 3" dia., 1" depth
7-3-202	7/16" - 3" dia., 2" depth
7-3-302	3/4" - 3" dia., 3" depth
For 1-1/4" Shanks	
7-3-1002	3-1/16" - 5-1/8" dia., 1" depth
7-3-2002	3-1/16" - 5-1/8" dia., 2" depth
7-3-3002	3-1/16" - 5-1/8" dia., 3" depth

Option for Cutters 3" and 4" Depth

7-3-402	2-piece pin for 3" and 4" depth cutters with 8mm pilot hole.
---------	--------------------------------------------------------------

Option for Cutters 6" and 8" Depth

9-3-602 C	Pin for 6" depth cutters with 8mm pilot hole.
9-3-802 C	Pin for 8" depth cutters with 8mm pilot hole.

† We also stock 8" depth HSS cutters and Metric HSS cutters. Larger diameters and special sizes available upon request. Please call us for pricing and delivery.



➤ See pages 65-71 for Drill Accessories

Unibroach® Annular Cutters

TiAlN Carbide coating for up to 4x tool life, less friction and more power

Less Friction = Less Heat = More Holes!

ANNULAR CUTTERS



ARMOR-PLATED Unibroach™ Cutters, at 90Rc hardness, are the state-of-the-art in hole cutting technology. They multiply service life, reduce cost and increase productivity.

ARMOR-PLATED Unibroach™ cutters are available in the following sizes:

Drill Depth	1"	2"	3"
Diameter	∅ 7/16" to ∅ 5 1/8"	∅ 7/16" to ∅ 5 1/8"	∅ 3/4" to ∅ 5 1/8"



Special sizes available; metric cutters available on request.

Every annular cutter up to 4" DOC includes a corresponding pilot pin.

- 3 to 4 times longer tool life with TiAlN Carbide coating
- Drill with less friction and more power
- Withstands higher working temperatures – up to 1480°F (800°C)
- Dry drilling or lubricating with water simplifies working conditions and cleanup*
- Prevents cold weld – metal chips do not adhere to the cutter
- Ideal for structural steel and hard metal
- 3/4" dia. shank (1 1/4" dia. shank available)

After the TiAlN Carbide coating is worn, lubricate with cutting oil



**Annular Cutter
Recommended
Revolutions Per Minute**
Recommended Feed Rate:
.002 - .004 inches per revolution

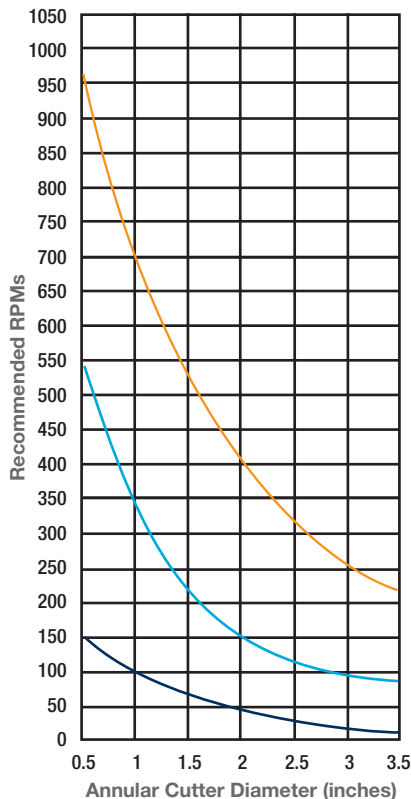

Aluminum
200 ft./min.

**Mild Steel
(Carbon)**
80 ft./min.

**High Tensile
Steel
(Stainless)**
30 ft./min.

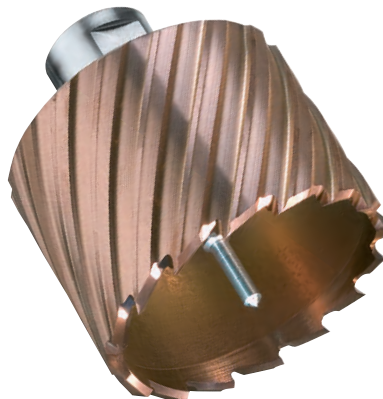

See page 65 for ARMOR-PLATED Unibroach™ TiAlN Carbide-Coated Annular Cutter Starter Kit.

* Pilot pins supplied with annular cutters up to 4" DOC. Other pilot pins can be purchased separately.

8-Series ARMOR-PLATED TiAIN

ARMOR-PLATED = Less Friction = Less Heat = More Holes!
Increase tool life and achieve faster feed rates



Shank size: 3/4" up to 3" dia.

ARMOR-PLATED Unibroach™ Cutters, at 90Rc hardness, are the state-of-the-art in hole cutting technology. They multiply service life, reduce cost and increase productivity.



Pilot pin included with every annular cutter up to 4" DOC

1" Depth	
Order No.	Diameter
8-1-114 T	7/16"
8-1-116 T	1/2"
8-1-118 T	9/16"
8-1-120 T	5/8"
8-1-122 T	11/16"
8-1-124 T	3/4"
8-1-126 T	13/16"
8-1-128 T	7/8"
8-1-130 T	15/16"
8-1-132 T	1"
8-1-134 T	1-1/16"
8-1-136 T	1-1/8"
8-1-138 T	1-3/16"
8-1-140 T	1-1/4"
8-1-142 T	1-5/16"
8-1-144 T	1-3/8"
8-1-146 T	1-7/16"
8-1-148 T	1-1/2"
8-1-150 T	1-9/16"
8-1-152 T	1-5/8"
8-1-154 T	1-11/16"
8-1-156 T	1-3/4"
8-1-158 T	1-13/16"
8-1-160 T	1-7/8"
8-1-162 T	1-15/16"
8-1-164 T	2"
8-1-166 T	2-1/16"

2" Depth	
Order No.	Diameter
8-1-214 T	7/16"
8-1-216 T	1/2"
8-1-218 T	9/16"
8-1-220 T	5/8"
8-1-222 T	11/16"
8-1-224 T	3/4"
8-1-226 T	13/16"
8-1-228 T	7/8"
8-1-230 T	15/16"
8-1-232 T	1"
8-1-234 T	1-1/16"
8-1-236 T	1-1/8"
8-1-238 T	1-3/16"
8-1-240 T	1-1/4"
8-1-242 T	1-5/16"
8-1-244 T	1-3/8"
8-1-246 T	1-7/16"
8-1-248 T	1-1/2"
8-1-250 T	1-9/16"
8-1-252 T	1-5/8"
8-1-254 T	1-11/16"
8-1-256 T	1-3/4"
8-1-258 T	1-13/16"
8-1-260 T	1-7/8"
8-1-262 T	1-15/16"
8-1-264 T	2"
8-1-266 T	2-1/16"

3" Depth*	
Order No.	Diameter
N/A	
N/A	
N/A	
N/A	
N/A	
8-1-324 T	3/4"
8-1-326 T	13/16"
8-1-328 T	7/8"
8-1-330 T	15/16"
8-1-332 T	1"
8-1-334 T	1-1/16"
8-1-336 T	1-1/8"
8-1-338 T	1-3/16"
8-1-340 T	1-1/4"
8-1-342 T	1-5/16"
8-1-344 T	1-3/8"
8-1-346 T	1-7/16"
8-1-348 T	1-1/2"
8-1-350 T	1-9/16"
8-1-352 T	1-5/8"
8-1-354 T	1-11/16"
8-1-356 T	1-3/4"
8-1-358 T	1-13/16"
8-1-360 T	1-7/8"
8-1-362 T	1-15/16"
8-1-364 T	2"
8-1-366 T	2-1/16"

* Cutters with 3" depth have an 8mm dia. pilot hole.

ARMOR-PLATED Cutter Kits

Each armor-plated cutter kit comes with the following: 9/16", 11/16", 13/16", 15/16", 1-1/16", pilot pins & carrying case.

Order No.	Description
8-1-001 T	1" depth Cutter Kit
8-1-002 T	2" depth Cutter Kit

Pilot Pins for 8-Series

Order No.	Description
For 3/4" Shanks	
7-3-102	7/16" - 3" dia., 1" depth
7-3-202	7/16" - 3" dia., 2" depth
7-3-302	3/4" - 3" dia., 3" depth

Option for Cutters 3" and 4" Depth

	
7-3-402	2-piece pin for 3" and 4" depth cutters with 8mm pilot hole.

3"+ Diameter Cutters

Metric and larger diameter cutters available on request.

ARMOR-PLATED Unibroach™ TiAIN Carbide-Coated Cutters:

- Drill with less friction and more power
- Withstand higher working temperatures – up to 1480°F (800°C)
- Dry drill or lubricate with water to simplify working conditions and cleanup**
- Prevent cold weld – metal chips do not adhere to the cutter
- Are ideal for structural steel and hard metal

** After the TiAIN Carbide coating is worn, lubricate with cutting oil

➤ See pages 65-71 for Drill Accessories

Unibroach® Annular Cutters

TCT Carbide Hornet – tungsten carbide-tipped for high-speed cutting

ANNULAR CUTTERS



- Use high-speed RPM for best results and faster holmaking
- Ideal for drilling steel with rust or paint and bolting applications
- Will outlast High-speed Steel cutters
- Leaves a burr-free finished hole
- Available in all sizes (fractional and metric)
- 2 flats
- $\frac{3}{4}$ " or $1\frac{1}{4}$ " shank

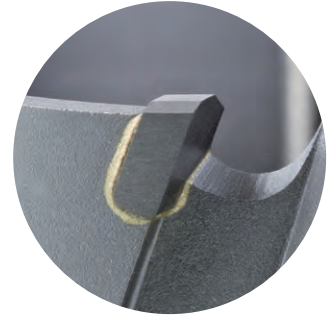

Closeup of tungsten-carbide teeth.

TCT Hornet cutters are available in the following sizes:

Drill Depth	1"	1-3/8"	2-3/8"	3-3/8"	4"	6"	8"
Diameter	$\varnothing \frac{1}{2}$ " to $\varnothing 1\frac{1}{2}$ "	$\varnothing \frac{19}{16}$ " to $\varnothing 2$ "	$\varnothing \frac{1}{2}$ " to $\varnothing 5\frac{1}{8}$ "	$\varnothing \frac{3}{4}$ " to $\varnothing 5\frac{1}{8}$ "	$\varnothing \frac{3}{4}$ " to $\varnothing 6$ "	$\varnothing \frac{13}{16}$ " to $\varnothing 6$ "	$\varnothing \frac{13}{16}$ " to $\varnothing 6$ "

Special sizes available; metric cutters available on request.

*Every annular cutter up to 4" DOC includes a corresponding pilot pin.**



Armor plating available upon request.



* Pilot pins supplied with annular cutters up to 4" DOC. Other pilot pins can be purchased separately.

9-Series Annular Cutter Recommended RPM Rates

Cutter Size	Stainless & Alloy Steel	Mild Steel	Iron Plate
	RPM	RPM	RPM
$\frac{1}{2}$ " - $\frac{5}{8}$ "	500 - 800	600 - 1000	800 - 1200
$\frac{11}{16}$ " - $\frac{13}{16}$ "	400 - 640	480 - 800	640 - 960
$\frac{7}{8}$ " - $\frac{15}{16}$ "	330 - 530	400 - 660	530 - 800
1" - $1\frac{3}{16}$ "	270 - 420	320 - 530	420 - 640
$1\frac{1}{4}$ " - $1\frac{3}{8}$ "	230 - 370	270 - 460	360 - 550
$1\frac{7}{16}$ " - $1\frac{9}{16}$ "	200 - 320	240 - 400	320 - 480
$1\frac{5}{8}$ " - $1\frac{3}{4}$ "	180 - 280	210 - 350	280 - 420
$1\frac{13}{16}$ " - 2"	160 - 260	190 - 320	260 - 380
$2\frac{1}{16}$ " - $2\frac{3}{16}$ "	145 - 230	170 - 290	230 - 350
$2\frac{1}{4}$ " - $2\frac{3}{8}$ "	135 - 210	160 - 270	210 - 320
$2\frac{7}{16}$ " - $2\frac{9}{16}$ "	120 - 200	150 - 250	200 - 300
$2\frac{5}{8}$ " - $2\frac{3}{4}$ "	115 - 180	140 - 230	180 - 270
$2\frac{13}{16}$ " - $2\frac{15}{16}$ "	110 - 170	130 - 210	170 - 260
3" - $3\frac{1}{8}$ "	100 - 160	120 - 200	160 - 240
$3\frac{3}{16}$ " - $3\frac{3}{8}$ "	95 - 150	115 - 190	150 - 230
$3\frac{7}{16}$ " - $3\frac{9}{16}$ "	90 - 140	110 - 180	140 - 210
$3\frac{5}{8}$ " - $3\frac{3}{4}$ "	85 - 135	105 - 170	135 - 200
$3\frac{13}{16}$ " - $3\frac{15}{16}$ "	80 - 130	95 - 160	130 - 195
4" - $4\frac{5}{16}$ "	70 - 120	90 - 145	120 - 170
$4\frac{3}{8}$ " - $4\frac{3}{4}$ "	70 - 110	80 - 135	110 - 160
$4\frac{13}{16}$ " - $5\frac{1}{8}$ "	65 - 100	75 - 125	100 - 150

9-Series - TCT Carbide Hornet

1" Depth

Order No.	Diameter
9-1-116 C	1/2"
9-1-118 C	9/16"
9-1-120 C	5/8"
9-1-122 C	11/16"
9-1-124 C	3/4"
9-1-126 C	13/16"
9-1-128 C	7/8"
9-1-130 C	15/16"
9-1-132 C	1"

1-3/8" Depth

Order No.	Diameter
9-1-134 C	1-1/16"
9-1-136 C	1-1/8"
9-1-138 C	1-3/16"
9-1-140 C	1-1/4"
9-1-142 C	1-5/16"
9-1-144 C	1-3/8"
9-1-146 C	1-7/16"
9-1-148 C	1-1/2"

2-3/8" Depth

Order No.	Diameter
9-1-216 C	1/2"
9-1-218 C	9/16"
9-1-220 C	5/8"
9-1-222 C	11/16"
9-1-224 C	3/4"
9-1-226 C	13/16"
9-1-228 C	7/8"
9-1-230 C	15/16"
9-1-232 C	1"
9-1-234 C	1-1/16"
9-1-236 C	1-1/8"
9-1-238 C	1-3/16"
9-1-240 C	1-1/4"
9-1-242 C	1-5/16"
9-1-244 C	1-3/8"
9-1-246 C	1-7/16"
9-1-248 C	1-1/2"
9-1-250 C	1-9/16"
9-1-252 C	1-5/8"
9-1-254 C	1-11/16"
9-1-256 C	1-3/4"
9-1-258 C	1-13/16"
9-1-260 C	1-7/8"
9-1-262 C	1-15/16"
9-1-264 C	2"

Order No.	Diameter
9-1-266 C	2-1/16"
9-1-268 C	2-1/8"
9-1-270 C	2-3/16"
9-1-272 C	2-1/4"
9-1-274 C	2-5/16"
9-1-276 C	2-3/8"
9-1-278 C	2-7/16"
9-1-280 C	2-1/2"
9-1-282 C	2-9/16"
9-1-284 C	2-5/8"
9-1-286 C	2-11/16"
9-1-288 C	2-3/4"
9-1-290 C	2-13/16"
9-1-292 C	2-7/8"
9-1-294 C	2-15/16"
9-1-296 C	3"
9-1-298 C	3-1/16"
9-1-2100 C	3-1/8"
9-1-2102 C	3-3/16"
9-1-2104 C	3-1/4"
9-1-2106 C	3-5/16"
9-1-2108 C	3-3/8"
9-1-2110 C	3-7/16"
9-1-2112 C	3-1/2"

3-3/8" Depth

Order No.	Diameter
9-1-322 C	11/16"
9-1-324 C	3/4"
9-1-326 C	13/16"
9-1-328 C	7/8"
9-1-330 C	15/16"
9-1-332 C	1"
9-1-334 C	1-1/16"
9-1-336 C	1-1/8"
9-1-338 C	1-3/16"
9-1-340 C	1-1/4"
9-1-342 C	1-5/16"
9-1-344 C	1-3/8"
9-1-346 C	1-7/16"
9-1-348 C	1-1/2"
9-1-350 C	1-9/16"
9-1-352 C	1-5/8"
9-1-354 C	1-11/16"
9-1-356 C	1-3/4"
9-1-358 C	1-13/16"
9-1-360 C	1-7/8"
9-1-362 C	1-15/16"
9-1-364 C	2"
9-1-366 C	2-1/16"

Order No.	Diameter
9-1-368 C	2-1/8"
9-1-370 C	2-3/16"
9-1-372 C	2-1/4"
9-1-374 C	2-5/16"
9-1-376 C	2-3/8"
9-1-378 C	2-7/16"
9-1-380 C	2-1/2"
9-1-382 C	2-9/16"
9-1-384 C	2-5/8"
9-1-386 C	2-11/16"
9-1-388 C	2-3/4"
9-1-390 C	2-13/16"
9-1-392 C	2-7/8"
9-1-394 C	2-15/16"
9-1-396 C	3"
9-1-398 C	3-1/16"
9-1-3100 C	3-1/8"
9-1-3102 C	3-3/16"
9-1-3104 C	3-1/4"
9-1-3106 C	3-5/16"
9-1-3108 C	3-3/8"
9-1-3110 C	3-7/16"
9-1-3112 C	3-1/2"
9-1-3114 C	3-9/16"

Order No.	Diameter
9-1-150 C	1-9/16"
9-1-152 C	1-5/8"
9-1-154 C	1-11/16"
9-1-156 C	1-3/4"
9-1-158 C	1-13/16"
9-1-160 C	1-7/8"
9-1-162 C	1-15/16"
9-1-164 C	2"

Order No.	Diameter
9-1-3116 C	3-5/8"
9-1-3118 C	3-11/16"
9-1-3120 C	3-3/4"
9-1-3122 C	3-13/16"
9-1-3124 C	3-7/8"
9-1-3126 C	3-15/16"
9-1-3128 C	4"
9-1-3130 C	4-1/16"
9-1-3132 C	4-1/8"
9-1-3134 C	4-3/16"
9-1-3136 C	4-1/4"
9-1-3138 C	4-5/16"
9-1-3140 C	4-3/8"
9-1-3142 C	4-7/16"
9-1-3144 C	4-1/2"
9-1-3146 C	4-9/16"
9-1-3148 C	4-5/8"
9-1-3150 C	4-11/16"
9-1-3152 C	4-3/4"
9-1-3154 C	4-13/16"
9-1-3156 C	4-7/8"
9-1-3158 C	4-15/16"
9-1-3160 C	5"
9-1-3162 C	5-1/8"



Shank size:

3/4" for cutters up to 3" dia.
1-1/4" for cutters 3-1/16 to 5-1/8" dia.

Pilot pin included with every annular cutter up to 4" DOC

Cutter Kits

Each hornet carbide cutter kit comes with the following: 9/16", 11/16", 13/16", 15/16", 1-1/16", pilot pins & carrying case.

Order No.	Description
9-1-001 C	1" depth Cutter Kit
9-1-002 C	2-3/8" depth Cutter Kit

****We also stock Metric Carbide cutters. Please call us for pricing and delivery. Larger diameters and special sizes are available upon request.**

Pilot Pins for 9-Series

Order No.	Description
For 3/4" Shanks	
9-3-101 C	1/2" - 1-1/2" dia., 1" depth
9-3-102 C	1-9/16" - 2" dia., 1-3/8" depth
9-3-202 C	1/2" - 3" dia., 2-3/8" depth
9-3-302 C	3/4" - 3" dia., 3-3/8" depth
For 1-1/4" Shanks	
9-3-202A C	3-1/16" - 5-1/8" dia., 2-3/8" depth
9-3-302A C	3-1/16" - 5-1/8" dia., 3-3/8" depth

Option for Cutters 3-3/8" and 4" Depth

7-3-402	2-piece pin for 3-3/8" and 4" depth cutters with 8mm pilot hole.
---------	------------------------------------------------------------------

Option for Cutters 6" and 8" Depth

9-3-602 C	Pin for 6" depth cutters with 8mm pilot hole.
9-3-802 C	Pin for 8" depth cutters with 8mm pilot hole.



➤ See pages 65-71 for Drill Accessories

10-Series One-Touch TCT

Tungsten carbide-tipped with one-touch shank



- No-tool cutter replacement
- When holding with a set screw, tighten to weld on flat rather than dimple area
- Leaves a burr-free finished hole
- 3/4" shank
- Compatible with Nitto Kohki and other auto-feed machines
- Armor plating also available upon request



One-Touch TCT cutters are available in the following sizes:

- 1-3/8" drill depth – \varnothing 1/2" to \varnothing 2"
- 2-3/8" drill depth – \varnothing 1/2" to \varnothing 2³/₄"
- 3-3/8" drill depth – \varnothing 1¹/₁₆" to \varnothing 1¹/₁₆"

Every 10-Series annular cutter includes a corresponding pilot pin.

- Metric cutters available on request

1-3/8" Depth	
Order No.	Diameter
10-1-116 C	1/2"
10-1-118 C	9/16"
10-1-120 C	5/8"
10-1-122 C	11/16"
10-1-124 C	3/4"
10-1-126 C	13/16"
10-1-128 C	7/8"
10-1-130 C	15/16"
10-1-132 C	1"
10-1-134 C	1-1/16"
10-1-136 C	1-1/8"
10-1-138 C	1-3/16"
10-1-140 C	1-1/4"
10-1-142 C	1-5/16"
10-1-144 C	1-3/8"
10-1-146 C	1-7/16"
10-1-148 C	1-1/2"
10-1-150 C	1-9/16"
10-1-152 C	1-5/8"
10-1-154 C	1-11/16"
10-1-156 C	1-3/4"
10-1-158 C	1-13/16"
10-1-160 C	1-7/8"
10-1-162 C	1-15/16"
10-1-164 C	2"

2-3/8" Depth	
Order No.	Diameter
10-1-216 C	1/2"
10-1-218 C	9/16"
10-1-220 C	5/8"
10-1-222 C	11/16"
10-1-224 C	3/4"
10-1-226 C	13/16"
10-1-228 C	7/8"
10-1-230 C	15/16"
10-1-232 C	1"
10-1-234 C	1-1/16"
10-1-236 C	1-1/8"
10-1-238 C	1-3/16"
10-1-240 C	1-1/4"
10-1-242 C	1-5/16"
10-1-244 C	1-3/8"
10-1-246 C	1-7/16"
10-1-248 C	1-1/2"
10-1-250 C	1-9/16"
10-1-252 C	1-5/8"
10-1-254 C	1-11/16"
10-1-256 C	1-3/4"
10-1-258 C	1-13/16"
10-1-260 C	1-7/8"
10-1-262 C	1-15/16"
10-1-264 C	2"

3-3/8" Depth	
Order No.	Diameter
10-1-322 C	11/16"
10-1-326 C	13/16"
10-1-330 C	15/16"
10-1-334 C	1-1/16"

Pilot pin included with every 10-Series annular cutter



Shank size: 3/4"

Pilot Pins for 10-Series

Order No.	Description
For 3/4" Shanks	
9-3-102 C	9/16" - 2" dia., 1-3/8" depth
9-3-202 C	1/2" - 2-3/4" dia., 2-3/8" depth
9-3-302 C	11/16" - 1-1/16" dia., 3-3/8" depth

➤ See pages 65-71 for Drill Accessories

Rail Cutters

Cut holes up to 1-11/16" dia. in track rail

- Round, clean, burr-free hole – better than spade drills
- 3/4" shank
- More cutting teeth to distribute the load evenly – increase tool life and achieve faster feed rates
- Pilot pin included with each 4-Series cutter
- Armor plating available upon request



4-Series Carbide-Tipped Rail Cutters

- Carbide-tipped rail bits for long life and quick, efficient cutting through rust and corrosion

1-3/8" Depth			
Order No.	Diameter	Order No.	Diameter
4-1-124 C	3/4"	4-1-140 C	1-1/4"
4-1-128 C	7/8"	4-1-142 C	1-5/16"
4-1-130 C	15/16"	4-1-144 C	1-3/8"
4-1-132 C	1"	4-1-146 C	1-7/16"
4-1-134 C	1-1/16"	4-1-148 C	1-1/2"
4-1-136 C	1-1/8"	4-1-152 C	1-5/8"
4-1-138 C	1-3/16"	4-1-154 C	1-11/16"



Pilot Pin for 4-Series

Order No.	Description
For 3/4" Shanks	
4-3-102	3/4" - 1-11/16" dia., 1-3/8" depth

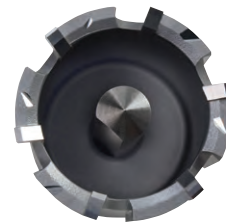

47-Series Lightning Rail Cutters

- Cobalt rail bits for increased wear resistance
- Thick cutter wall for extra durability and extended tool life
- Turn-style mounting allows quick and easy installation without tools.

1-1/4" Depth			
Order No.	Diameter	Order No.	Diameter
47-1-124 C	3/4"	47-1-140 C	1-1/4"
47-1-128 C	7/8"	47-1-142 C	1-5/16"
47-1-130 C	15/16"	47-1-144 C	1-3/8"
47-1-132 C	1"	47-1-146 C	1-7/16"
47-1-134 C	1-1/16"	47-1-148 C	1-1/2"
47-1-136 C	1-1/8"	47-1-152 C	1-5/8"
47-1-138 C	1-3/16"	47-1-154 C	1-11/16"



Unibroach® Cobalt Cutters

- 5% cobalt for increased wear resistance
- Excellent results when drilling high-tensile steel and difficult-to-machine materials
- Available with TiAlN coating upon request
- Available for hole sizes up to 5" dia.
- 3/4" shank is standard for cutters up to 3" dia.
- Metric cutters available on request
- See our price list for part numbers

➤ See pages 65-71 for Drill Accessories

Carbide-Tipped Hole Saws

CARBIDE-TIPPED HOLE SAWS



Cut holes in steel plate up to 3/8" thick



Model EHB 16/2.4 S R/L C: 2-speed, variable-speed drill with safety clutch

- Tungsten carbide-tipped cutting edges last longer and can be run at higher feeds and speeds to create holes of exceptional quality and accuracy
- One-piece construction; diameters from 9/16" to 4 1/2"

Designed for use with hand-held drills – recommended drills include our EHB 16 series or other hand-held drills with slip clutch – [see page 72](#)



1-Series Carbide-Tipped Hole Cutters

**1" effective length
Center twist pilot drill
Safety Collar Stop**

3/8" shank on cutters up to 3-1/4" dia.
1/2" shank on cutters 3-5/16" dia. and larger

2-Series Carbide-Tipped Hole Cutters Extra Heavy Duty

**5/8" effective length
Spring-loaded Pilot Pin**

Cutters feature milled, 3-flat shank designed to fit 1/2" chucks.



Order No.	Diameter
1-1-118*	9/16"
1-1-120*	5/8"
1-1-122	11/16"
1-1-124	3/4"
1-1-126	13/16"
1-1-128	7/8"
1-1-130	15/16"
1-1-132	1"
1-1-134	1-1/16"
1-1-136	1-1/8"
1-1-138	1-3/16"
1-1-140	1-1/4"
1-1-142	1-5/16"
1-1-144	1-3/8"
1-1-146	1-7/16"
1-1-148	1-1/2"
1-1-150	1-9/16"
1-1-152	1-5/8"
1-1-154	1-11/16"
1-1-156	1-3/4"
1-1-158	1-13/16"
1-1-160	1-7/8"
1-1-162	1-15/16"
1-1-164	2"

Order No.	Diameter
1-1-166	2-1/16"
1-1-168	2-1/8"
1-1-170	2-3/16"
1-1-172	2-1/4"
1-1-174	2-5/16"
1-1-176	2-3/8"
1-1-178	2-7/16"
1-1-180	2-1/2"
1-1-182	2-9/16"
1-1-184	2-5/8"
1-1-186	2-11/16"
1-1-188	2-3/4"
1-1-190	2-13/16"
1-1-192	2-7/8"
1-1-194	2-15/16"
1-1-196	3"
1-1-198	3-1/16"
1-1-1100	3-1/8"
1-1-1102	3-3/16"
1-1-1104	3-1/4"
1-1-1106	3-5/16"
1-1-1108	3-3/8"
1-1-1110	3-7/16"
1-1-1112	3-1/2"

Order No.	Diameter
1-1-1114	3-9/16"
1-1-1116	3-5/8"
1-1-1118	3-11/16"
1-1-1120	3-3/4"
1-1-1122	3-13/16"
1-1-1124	3-7/8"
1-1-1126	3-15/16"
1-1-1128	4"
1-1-1136	4-1/4"
1-1-1144	4-1/2"

1-Series Accessories

Order No.	Description
1-1-drill	Center Pilot Drill
1-1-spring	Spring
1-1-screw	Screw

Order No.	Diameter
2-1-118	9/16"
2-1-120	5/8"
2-1-122	11/16"
2-1-124	3/4"
2-1-126	13/16"
2-1-128	7/8"
2-1-130	15/16"
2-1-132	1"
2-1-134	1-1/16"
2-1-136	1-1/8"
2-1-138	1-3/16"
2-1-140	1-1/4"
2-1-142	1-5/16"
2-1-144	1-3/8"

2-Series Accessories

Order No.	Description
2-1-pilot	Pilot/Ejector Pin
2-1-screw	Screw



* These cutters do not include springs.

Accessories

Starter Kits

CS Unitec starter kits offer the essentials you need to begin drilling. We have three options that provide a cost-effective tool set for your application.



HSS Steel Cutter Starter Kit

ZST 100S Kit Includes:

Set of 5 annular cutters (one each of the following):

- 9/16" dia. x 1" depth (6-1-118)
- 11/16" dia. x 1" depth (6-1-122)
- 13/16" dia. x 1" depth (6-1-126)
- 15/16" dia. x 1" depth (6-1-130)
- 1-1/16" dia. x 1" depth (6-1-134)

2 pilot pins • 1 cutter storage box • 1 Power Worker magnetic stick (POW 100)
1 quart high-performance cutting oil (ZHS 006)

See pages 56-57 for more information on HSS annular cutters.



Armor-Plated TiAlN Carbide-Coated Cutter Starter Kit

ZST 100P Kit Includes:

Set of 5 annular cutters (one each of the following):

- 9/16" dia. x 1" depth (8-1-118)
- 11/16" dia. x 1" depth (8-1-122)
- 13/16" dia. x 1" depth (8-1-126)
- 15/16" dia. x 1" depth (8-1-130)
- 1-1/16" dia. x 1" depth (8-1-134)

2 pilot pins • 1 cutter storage box • 1 Power Worker magnetic stick (POW 100)
1 quart high-performance cutting oil (ZHS 006)

See pages 58-59 for more information on Armor-Plated TiAlN Carbide-Coated annular cutters.

Other annular cutter kits are available – contact CS Unitec for details.



HSS Steel Cutter Starter Kit with Power Cleaner

ZST 200S Kit Includes:

Set of 5 annular cutters (one each of the following):

- 9/16" dia. x 1" depth (6-1-118)
- 11/16" dia. x 1" depth (6-1-122)
- 13/16" dia. x 1" depth (6-1-126)
- 15/16" dia. x 1" depth (6-1-130)
- 1-1/16" dia. x 1" depth (6-1-134)

2 pilot pins • 1 cutter storage box • 1 Power Cleaner (POW 200)
1 quart high-performance cutting oil (ZHS 006)

See pages 56-57 for more information on HSS annular cutters.



See page 70 for more information on the Power Cleaner (POW 200) and Power Worker magnetic stick (POW 100)



Accessories

Coolants and Cutting Pastes

Coolant extends the life of cutting tools – Ideal for cutting steel, stainless steel and hard metals

ProLube™

Your cutting tools will work cooler, longer and more efficiently with ProLube™ Lubricants from CS Unitec.

- Prolong tool life by reducing friction and wear
- Unique composition provides excellent adhesion to cutting tools for maximum lubrication
- Corrosion inhibitor
- Non-toxic



**Water soluble
16:1**

ProLube™

Paste (12 oz. tub) – Part No. **CS 7030-712**

Liquid (1 gallon) – Part No. **CS 7010-504**



- High-performance
- Liquid coolant is concentrated for dilution with water
- Eco-friendly

Paste (tube) – Part No. **ZHS 570**

Paste (12-pack tubes) – Part No. **ZHS 572**

Paste (2.2 lb. tub) – Part No. **ZHS 550**

Liquid (1 quart) – Part No. **ZHB 001**

Upgrade your drill's cooling system: see page 67 for arbors with automatic cooling.

Cutting Oil

- High-performance, biodegradable, non-hazardous oils and pastes
- Oils for heavy removal of metal, including stainless steel
- Chlorine-free (MSDS on bottle/tub)
- Not necessary to dilute with water

Cutting Oil:

Part No. **ZHS 006** (quart)

Part No. **ZHS 005** (gallon)



Pressurized Coolant Bottle

Use with any automatic internal lubrication system.
Part No. **9 4002 0020 N**

Pilot Pins for Cutters

- Milled channel efficiently supplies internal lubrication to cutting teeth
- Available for cutter diameters ranging from 7/16" to 5 1/8" and up to 8" depth of cut
- See price list for part numbers



**Shown at right:
2-piece pin for
3" and 4" depth
cutters with
8mm pilot hole
(Part No. 7-3-402).**

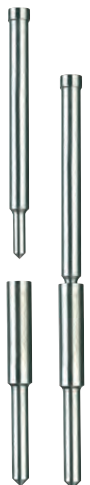

Accessories



Arbors for Annular Cutters

- Use on any magnetic drill stand, drill press or shop equipment with a Morse Taper intake of No. 2, 3 or 4
- Available for Annular Cutter shank sizes of 3/4" or 1 1/4" Weldon
- Available for automatic internal cooling or manual cooling



Manual Cooling

- ZIA 219M** – Morse Taper No. 2
3/4" arbor bore
- ZIA 319M** – Morse Taper No. 3
3/4" arbor bore
- ZIA 30/75** – Morse Taper No. 3
3/4" arbor bore, 3" depth
- ZIA 419M** – Morse Taper No. 4
3/4" arbor bore



Automatic Cooling

- ZIA 219KN** – Morse Taper No. 2
3/4" arbor bore
- ZIA 319KN** – Morse Taper No. 3
3/4" arbor bore
- ZIA 30/32** – Morse Taper No. 3
1 1/4" arbor bore
- ZIA 432 KN** – Morse Taper No. 4
1 1/4" arbor bore

Quick-Lock Arbor with Automatic Internal Cooling

- Keyless for fast, no-tools changeover for 3/4" dia. shank annular cutters
- Automatic internal cooling
- Turn, click... go!

ZSS 200 – Morse Taper No. 2
for 3/4" dia. shank
annular cutters

ZSS 300 – Morse Taper No. 3
for 3/4" dia. shank
annular cutters



**turn,
click...**



**Keyless,
quick-change
system for annular
cutters saves time
and money.**

Just twist and lock!



Drill Chucks for Straight-Shank Twist Drills

- Two capacities: 1/2" and 3/4"; four chucks and adapters to fit all magnetic drills

- A) **IBC 17** – 1/2" chuck for CSU 32 series
- B) **IBC 18** – 1/2" chuck with 3/4" shank for MABasic 200, MABasic 400 and AIRBOR™ (fits all drills with 3/4" arbor bore)
- C) **IBC 21** – 3/4" chuck with MT3 shank for MAB 525, MAB 825, MAB 845 and CSU 100/3RL
- D) **IBC 22** – 3/4" chuck with MT2 shank for MABasic 450, MAB 455, MAB 485 and CSU 50 series



Accessories

Extensions for Annular Cutters

Extra-long holders extend stroke of drills



- Extend cutter reach up to 18"
- Available for magnetic drills with 3/4" arbor bore or MT3
- Also available with 3 flats for straight shank drill chucks and R8 shanks for drill presses
- Drill difficult-to-reach areas
- Extend cutter reach over the side or through an existing hole*

7-9-902 – 2" extension
7-9-903 – 3" extension
7-9-906 – 6" extension
7-9-912 – 12" extension
7-9-918 – 18" extension

7-9-1146 – 6" extension,
 1-1/4" male x 1-1/4"
 female shank

* Hole diameter must be larger than 1 5/16"
 to accommodate width of extension



We also offer extensions with the following connections:

**3 Flats for Geared
 Chucks x
 3/4" arbor**



7-9-100 – 2-1/8" length, 1/2" shank
7-9-200 – 2" length, 3/4" shank

R8



7-9-500 – R8, 1-3/4" length; 3/4" arbor bore
7-9-506 – R8, 6" length; 3/4" arbor bore
7-9-700 – R8, 2-3/4" length; 1-1/4" arbor bore

2-in-1 Drill/Taps Drill and tap with one tool

National Coarse Threads (UNC) – sizes available:

CS500 – 1/2" x 13 UNC
CS625 – 5/8" x 11 UNC
CS750 – 3/4" x 10 UNC

CS875 – 7/8" x 9 UNC
CS1000 – 1" x 8 UNC
CSDT-UNCKIT – 1/2", 5/8", 3/4" & 1" drill/taps



82° and 90° Countersinks

- Manufactured of HSS with 5% cobalt
- 3/4" Weldon shank

Countersink hole sizes:

CTS 30 from 5/8" to 2" / 82°
CTS 50 from 5/8" to 2 1/8" / 90°



Detachable Chip Guard

Protects against flying chips when drilling



ZSS 050 – MAB 485 and MAB 525
ZSS 500 – MAB 825 and MAB 845

Quick-Change Tapping Chucks

Part No. **GSW.830C** tapping chuck includes two variable clamp collets to tap 3/8" to 1 1/8". It is the least expensive system if you will tap more than 4 sizes. **GSW.830C** has an MT3 connection.

For use with all MT3 drills.



Variable clamp collets for use in tap chuck No. **GSW.830C**:
 Part No. **GST-160** for shanks 3/8" – 5/8".
 Part No. **GST-230** for shanks 5/8" – 7/8".



**GSW 444
 Quick-
 Change
 Chuck**

Part No. **GSW 444** quick-change tapping chuck with MT4 connection (for MAB 1300). Collets not included.

Order Number	Tap Collet	Shank Diameter	Square Drive
GSS.420	20mm	16mm	12mm
GSS.422	22mm	18mm	14.5mm
GSS.427	27mm	20mm	16mm
GSS.433	33mm	32mm	20mm
GSS.442	42mm	32mm	24mm



**GSS-4xx
 Collet**

Clamping Devices

MobilCLAMP

A true advance in magnetic drilling technology: MobilCLAMP converts a magnetic drilling machine into a portable drill press.

MobilCLAMP extends the functionality of your portable magnetic drill - converting it to a drill press that can be easily transported to the jobsite. This unit makes it possible to drill, countersink, ream or tap small parts in any location with a flat surface.

The magnetic drill can be mounted onto the MobilCLAMP with only the power of the machine's magnet - no screws, clamps or other connections between the drill and the base. The magnetic drill becomes a multi-purpose machine for applications involving an annular cutter, twist drill, tap, countersink or reamer.

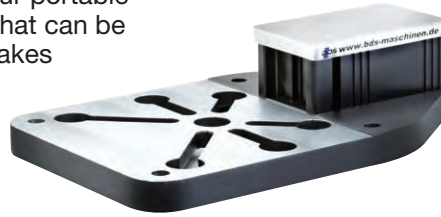

Drill not included.

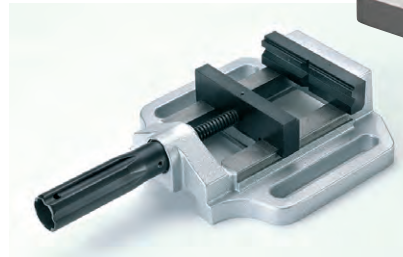

MobilCLAMP	
Order No.	ZMC 200 N
Jaw Width	4" (100mm)
Clamping Range	4" (100mm)

ZMC 200 N includes ZMC 200 base, ZST 300 vise, (2 qty.) ZTN 100 screw and (2 qty.) ZSN 100 hexagon nut with collar

Drilling stand and vise for hand drills



Drill not included.

- Industrial drilling pillars for commercial hand drills with 43mm chuck journal diameter.
- Optimum stability by cast base plate combined with a pillar top of the MAB series.
- Versatile usability by a drill vise with 4" (100mm) jaw width (special accessories).
- Screws for slots are available for additional security under higher loads (special accessories).
- Working stroke of 9" - 17" (230 - 425mm).

Magnetic Drilling Pillar

Order No. **MBS 300**

For hand drills with a 1-11/16" collar diameter and 7" stroke.



Drill not included.

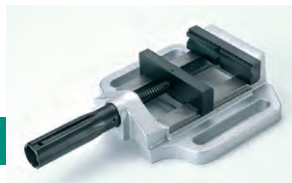

Vise

Order No. **ZST 300**
 jaw width: 4" (100mm)
 clamping range: 4" (100mm)

Drilling Pillar

Order No. **ZBS 100**



Accessories

- Screws for T-Slots – Order No. **ZTN 100**
- Hexagon Nut with Collar – Order No. **ZSM 100**

Vacuum Plates

For applications where drill alone will not adhere to surface

Vacuum Plate for Channeled Plates

Order No. **ZAV 301** (vacuum plate only)
 Order No. **ZAV 310** (vacuum plate and vacuum pump, 110V)

Ideal for channeled plates. High-performance vacuum pump with circular oil lubrication. Clamping plate diameter: 11.8"

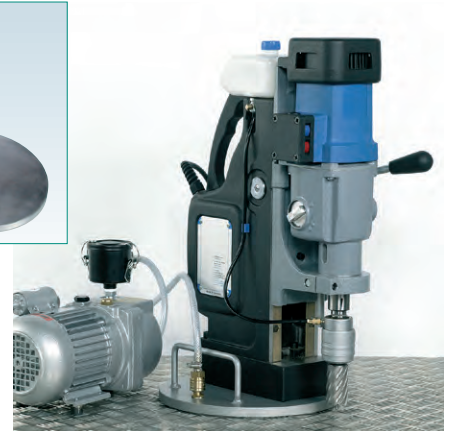

Vacuum Plate for Smooth Surfaces

Order No. **ZAV 401** (vacuum plate only)
 Order No. **ZAV 410** (vacuum plate and vacuum pump, 110V)

Ideal for smooth surfaces. High-performance vacuum pump with circular oil lubrication. Clamping plates with two suction surfaces and cut-through drilling area.



Metal Chip Cleanup Tools

- Easily clean up sharp-edged drill chips, screws and other metal parts
- Ideal for hard-to-reach spaces

Power Cleaner – POW 200

Two-in-one tool for removing chips



- Hook pulls away metal swarf from drill
- Brush cleans fine chips



Power Worker – POW 100

Simple cleanup of metal chips

- Items are safely ejected off of Power Worker without hand contact
- Rare earth magnet cleans metal parts and shavings

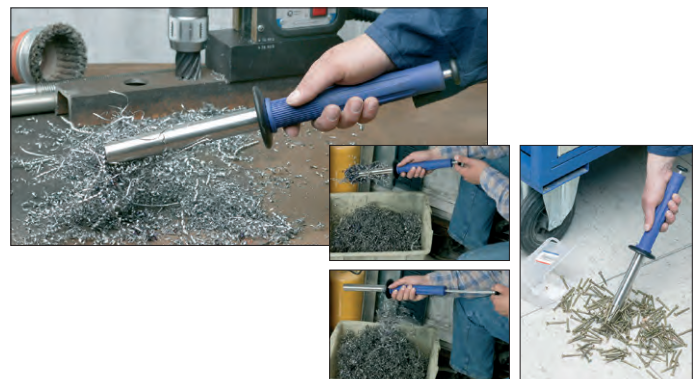

Pipe Saddle Clamp System

Ensures safe, secure drilling of pipes and tubular material



Ideal for applications requiring the flexibility of clamping on pipes from 3-1/4" to 20" diameter. These pipe clamp systems are flexible and easy to use. Swivelling V-blocks fit the contour of the pipe while the heavy-duty tension chains securely affix the clamps to the piece being drilled. The drilling position can be easily and safely adjusted.

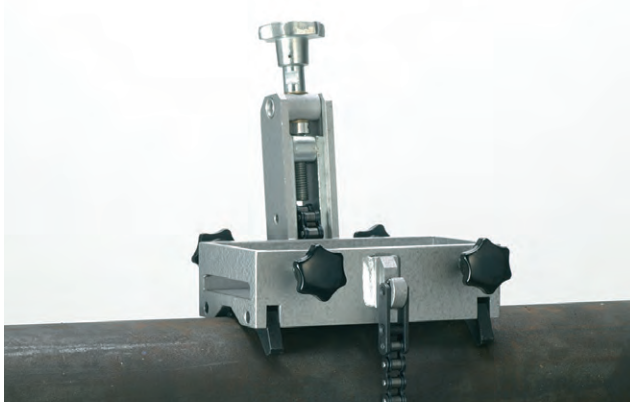

ZRO 250 Pipe Saddle Clamp System

Pipe diameters 3¹/₄" - 10"

Chain length: 35¹/₂"

If using on pipe larger than 10", need 1 qty. ZRO 001 extension chains.

For models: MABasic 200, MABasic 400, MABasic 450, MAB 455, MAB 465, MAB 485 and CSU 32RL



ZRO 500 Pipe Saddle Clamp System

Pipe diameters 6" - 20" (extension chain available)

Chain length: 65"

If using on pipe larger than 20", need 2 qty. ZRO 001 extension chains.

For models: MABasic 850, MAB 525, MAB 825, MAB 845, CSU 50 Series, CSU 100/3RL, AB-4300-2 and HB 4400

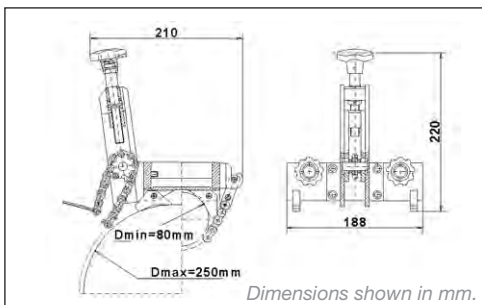

Order No. **ZRO 001** extension chain for ZRO 250 and ZRO 500 pipe saddle clamps. 35" length.

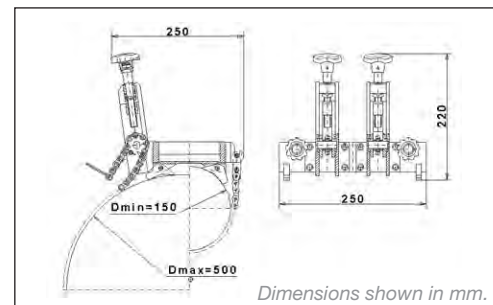

Electric Drills and Drive Units

High-torque, multi-gearred and variable-speed motors



Model EHB 16/2.4 S R/L C



Model EHB 20/2.4



Model EHB 32/4.2



Model EHB 16/1.4 S



Model EAU 34/4 CB



Model EAU 36/4 R R/L CB

Heavy-Duty Drills for Industry and Construction:

- High-torque output
- Variable-speed, two- and four-gearred drills for optimum speed selection
- Reversible motors and electronic torque control on selected models
- Ideal for special applications including valve turning, tube rolling and other jobs
- Safety slip clutch on 1¹/₄" capacities to protect operator and tool
- Drilling capacities up to 1¹/₄" in steel
- Special OEM motors available on request
- One-year warranty



Model No.	Motor Power (Amps)	Voltage	Load Speed (RPM)	Drilling Capacity in Steel	Max. Torque Output (ft./lbs.)	Reversible	Chuck/Arbor	Weight (lbs.)
EHB 16/1.4 S	7.3	110V	0-500	5/8"	12	NO	5/8" Keyless	6.8
EHB 16/1.4 S R/L	9.6	110V	0-450	5/8"	19	YES	5/8" Keyless	7
EHB 16/2.4 S R/L C	10	110V	0-430/0-760	5/8"	19	YES	5/8" Geared	7
EAW 16/2 R/L	9	110V	510/950	N/A	8	YES	5/8" X 16 UN	7
EHB 20/2.4	10.5	110V	250/450	3/4"	32	NO	MT2	9.2
EHB 32/4.2	15.5	110V	110/175/245/385	1 ¹ / ₄ "	112	NO	MT3	15.2
EAU 34/4 CB**	20	110V	80/130/360/570	-	203	YES	MT3	19.5
EAU 36/4 R R/L CB** with 4-speed gearbox and variable speed	22	110V	50-120 80-190 110-270 180-420	-	187	YES	MT3	20

* All units available in 220 Volt / 50Hz

** EAU 34/4 CB and EAU 36/4 R R/L CB include control box Special Motors available upon request.

Electric Drills and Drive Units

Slow Speed: two-gearred, variable-speed reversible motors



Model ETE 32/2.3 R/RL
(shown with optional Square Drive adapter)

- High-torque, two-gearred and variable-speed reversible motors
- Ideal for drilling, reaming and tapping steel
- Driving applications include mills, spindles, bar boring, pipe beveling and valve turning
- Perfect for tube rolling and expanding for fire tube and water tube boilers
- Mechanical safety clutch prevents operator injury or damage to the tool
- Morse Taper #3 arbor
- One-year warranty



Model EHB 32/2.2 R/RL
Model ETE 32/2.3 R/RL



Up to 1 1/4" twist drill capacity

1/2" and 3/4" Square Drive accessories allow motor compatibility for various drive applications.*



Model No.	Motor Power (Amps)	Voltage**	Load Speed (RPM)	Drilling Capacity in Steel	Tube Rolling (max.)	Reversible	Torque Output (ft./lbs.)	Torque Control	Arbor	Weight (lbs.)
EHB 32/2.2 R/RL	16.3	110V	60-140/ 200-470	1 1/4"	2"	YES	95 max.	YES	MT3	14
ETE 32/2.3 R/RL	16.3	110V	30-75/ 90-230	N/A	3" ***	YES	174 max.	7	MT3	15

** All units available in 220 Volt / 50Hz

*** With Expander (Up to 2 1/2" with Bead Roller)

* 1/2" Square Drive with MT3 – Part No. 830-1230-050

3/4" Square Drive with MT3 – Part No. 830-1230-075

Special Electric Motor Options

High-torque, reversible electric drill motors for custom applications

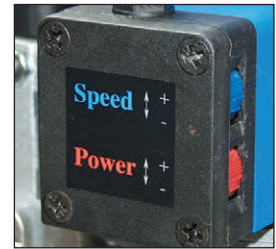
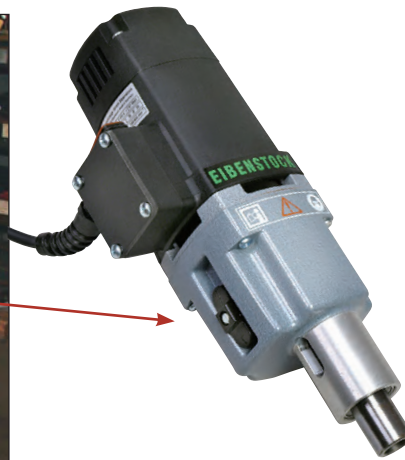
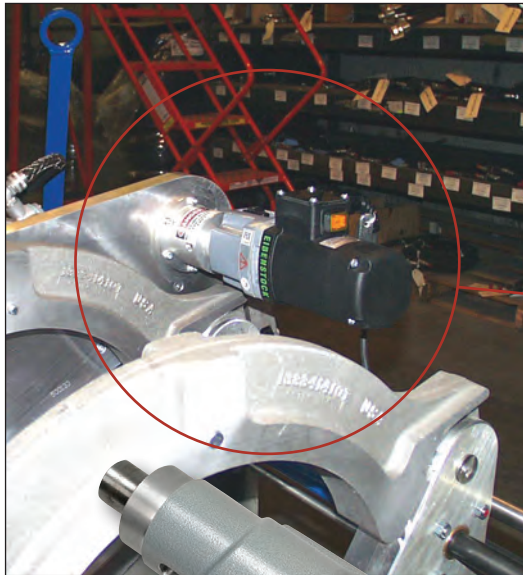

Control Boxes with On/Off, Variable Speed

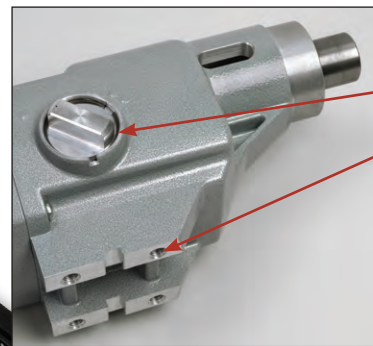

**Gear Selection Knob
Holes for Mounting
(Model EAU 34/4 only)**

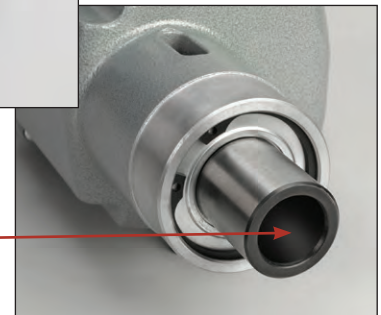

**Spindle Options:
MT2 / MT3
Square Drive
or Threaded**

Driving applications include mills, spindles, bar boring, tube rolling, valve turning and more.

Custom Design Options Include:

- ✓ **Forward/Reverse**
- ✓ **Variable Speeds**
- ✓ **Multiple Gears**
- ✓ **Spindle: MT or Special**
- ✓ **Multifunctional Control Boxes or Handles**
- ✓ **1/2 to 4 HP**
- ✓ **Modular Design**

Contact us today to configure the motor that meets your specific driving applications.



**Forward/Reverse Control
Electronic Torque Control
Variable-speed Dial**

Custom-Engineered Machines

Design a custom machine for your specific needs

Unusual applications require unique solutions. We can help you build custom drills for a wide variety of applications. With our considerable experience building custom drills, our engineers can assist you to create machines that can drill on uneven surfaces, in various directions, and more.

We enjoy a challenge! Contact us today for a professional solution for your unique application. Our capabilities include:

- In-house CAD design
- Prototype construction
- Manufacturing of special accessories

Custom Machine Options Include:

- ✓ **Reverse Drilling**
- ✓ **Alternative Mounting Configurations**
- ✓ **Magnet Variations**
- ✓ **Motor Customization**
- ✓ **Adjustable Drilling Depth**

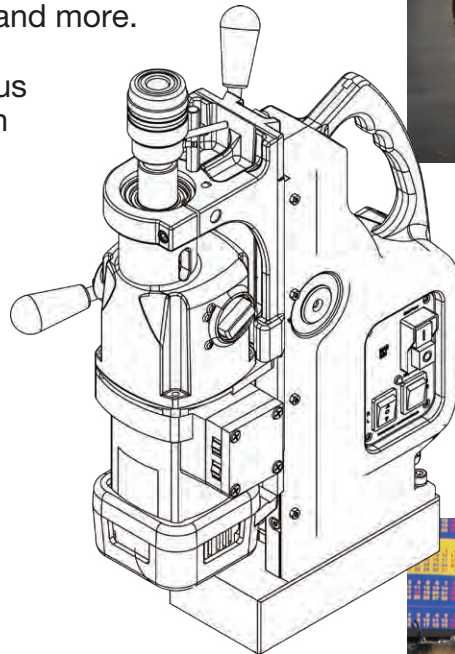

Machine rendering above shows reverse-mount motor for drilling upside down.

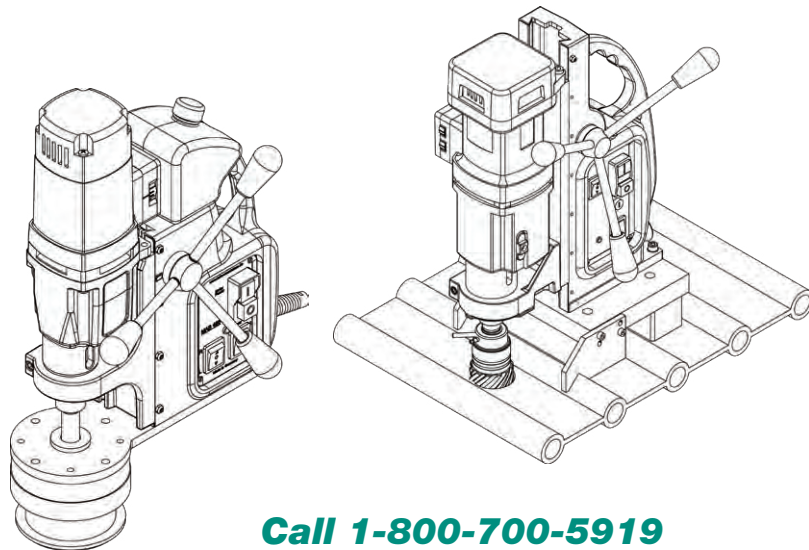

**Call 1-800-700-5919
for design assistance.**

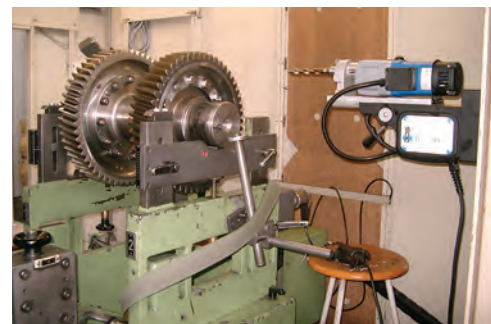
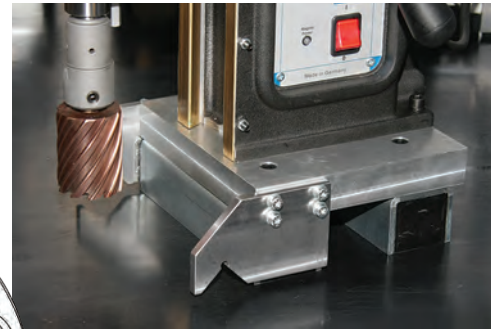

Pneumatic Drills and Drive Units

High-torque reversible drilling and tapping machines

ATEX



- High-torque reversible drilling, tapping and threading machines
- Ideal for drilling, reaming, tube rolling, tube expanding and tapping
- Special applications include mills, spindles, slides, controllers, pipe tapping, valve turning and more
- Drill chucks and Morse Taper arbors
- Hammer drills for drilling concrete with up to 2200 blows per minute
- Special OEM air motors available on request
- 6-month warranty

Morse Taper Drills w/ Feed Spindle



Model
2 2089 0030
with reverse and
safety twist throttle

D-handle Drills



Model
2 1310 0010

Pneumatic Hammer Drills



Model 2 1266 0010

Pneumatic Pistol Drills



Model
2 1261 0010



See page 78
for Rotary
Hammer Drills

Model No.	Motor Power (HP)	Load Speed (RPM)	Reversible	Chuck/ Arbor	Drilling Capacity in Steel	Tube Rolling Capacity	Torque Output (ft./lbs.)	CFM at 90 PSI	Length	Feed Length	Weight (lbs.)
Pistol Drills											
2 1261 0010	0.7	850	NO	1/2" Chuck	1/2"	N/A	7 max.	21	9 ³ / ₄ "	N/A	4.6
Hammer Drills (for concrete and underwater applications)											
2 1266 0010	0.75	950	NO	1/2" Chuck	1/2"	N/A	7 max.	21	12"	N/A	6.7
D-Handle Drills											
2 1310 0010	0.8	650	NO	1/2" Chuck	1/2"	N/A	8 max.	24	12 ¹ / ₂ "	N/A	12
2 1311 0010	0.8	650	NO	MT1	5/8"	N/A	8 max.	24	11"	N/A	12
Morse Taper Drills w/ Feed Spindle											
2 2089*	1.7	250	YES	MT3	1 ¹ / ₄ "	1"	36 max.	24	26 ¹ / ₂ "	1 ⁵ / ₈ "	28
2 2506*	2.5	220	YES	MT3	1 ¹ / ₄ "	2"	63 max.	70	26 ¹ / ₂ "	2 ¹ / ₂ "	32
2 2502*	2.5	80	YES	MT4	2"	2 ¹ / ₂ "	173 max.	70	26 ¹ / ₂ "	2 ¹ / ₂ "	37

* The last four digits of the Model No. identify the type of throttle.
Please specify the four digits when ordering: 0010 for Lever Throttle or 0030 for Safety Twist Throttle.

Corner Drills and Drives

ATEX



Pneumatic, electric and hydraulic: high-torque drilling, reaming and driving units



Model 2 1801 0030

Corner Drills and Bridge Reamers

- Small side-to-side distance for tight spaces
- Self-closing roll throttle
- Built-in oiler for motor
- Ideal for bridge reaming and drilling applications
- 6-month warranty
- Visit www.csunitec.com for dimensions

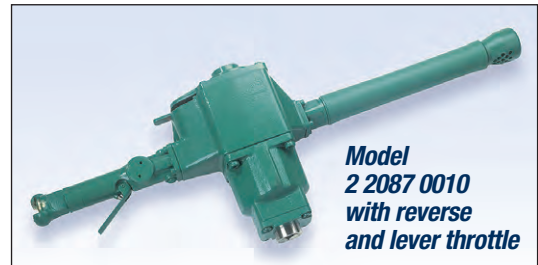
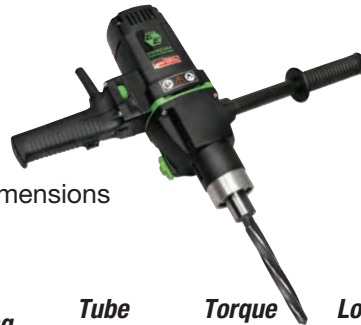

Model 2 2087 0010 with reverse and lever throttle

- Ideal for heavy-duty reaming, tube expanding and tapping
- Perfect for special driving applications, including pipe tapping and valve turning

Square Drive Accessories

- 2 2089 7020 – 7/8" Male Sq. Drive to 3/4" Male Sq. Drive
- 2 2089 7070 – 7/8" Male Sq. Drive to 1" Male Sq. Drive
- 6 1016 7940 – 7/8" Male Sq. Drive to 1" Male Sq. Drive with retaining pin

Pneumatic Corner Drill Model No.	Morse Taper	Drilling (in steel)	Reaming (in steel)	Tube Rolling Capacity	Torque Output (ft./lbs.)	Load Speed (RPM)	Motor Power (HP)	CFM at 90 PSI	Length	Weight (lbs.)
Nonreversible										
2 1602 0030	#1	5/8"	1/2"	N/A	7	500	0.7	21	12.5"	7
2 1701 0030	#2	7/8"	5/8"	N/A	35	270	1.8	49	20.9"	19
2 1801 0030	#3	1 1/4"	1"	N/A	53	260	2.6	63	22.5"	25
Reversible										
2 2104 0030	#4	2 1/8"	2"	2"	86	2 1/2"	3.0	71	23.8"	37

Model No. 2 1602 0030 has a 3/8" NPT air inlet. 1/2" (13mm) hose is recommended. All other models have 3/4" NPT air inlet. A 1/2" (13mm) hose is recommended for model 2 1701 0030. A 5/8" (15mm) hose is recommended for models 2 1801 0030 and 2 2104 0030.

Hydraulic Corner Drill Model No.	Morse Taper	Drilling (in steel)	Reaming (in steel)	Tube Rolling Capacity	Torque Output (ft./lbs.)	Load Speed (RPM)	Motor Power (HP)	Oil Flow/PSI	Length	Weight (lbs.)
2 1806 0010	#3	1 1/4"	1"	N/A	60	220	3.8	4 GPM @ 2000	21"	25

Electric Drill Model No.	Motor Power (Amps)	Voltage	Load Speed (RPM)	Drilling (in steel)	Tube Rolling Capacity	Reversible	Torque Output (ft./lbs.)	Torque Control	Arbor	Weight (lbs.)
EHB 32/2.2 R/RL	16.3	110	60-140, 200-470	1 1/4"	2"	Yes	92 max.	Yes	MT3	14

Pneumatic Drive Unit Model No.	Square Drive ID	Torque Output (ft./lbs.)	Load Speed (RPM)	Reversible	Tube Rolling Capacity	Tapping Capacity	Motor Power (HP)	CFM at 90 PSI	Height x Length	Weight (lbs.)
2 2081*	13/16"	413	20	YES	3"	1 1/2"	1.35	53	10.9" x 26.5"	29
2 2087*†	7/8"	413	5/8"	N/A	3"	1 1/2"	1.35	53	10.9" x 26.5"	29
2 2087*†	7/8"	138	2"	2"	2"	3/4"	1.35	53	10.9" x 26.5"	29

* The last four digits of the Model No. identify the type of throttle. † Square drive accessories available (see above). Please specify the four digits when ordering: 0010 for Lever Throttle or 0030 for Safety Twist Throttle.

SDS Rotary Hammer Drills

ATEX

Pneumatic and hydraulic: powerful percussion drilling for concrete and masonry

- SDS Plus or SDS Max models
- Safety clutch protects against overloading and jamming
- Hammer drill holes in concrete, brick and masonry
- Rotary drilling mode for straight drilling of steel and wood
- Open center hydraulic standard, closed center optional

SDS Max – Modes of Operation

2" bit capacity for drilling concrete and masonry

Hammer with Rotation
Ideal for concrete drilling

Rotation Only For drilling steel and wood (not reversible)



Air Model 2 2417 0010
SDS Max



Hydraulic Model 2 2418 0010
SDS Max

Second handle position
SAE #8 port for hydraulic hose connection



Air Model 2 2404 0010
SDS Plus up to 1" dia.



SDS Plus – Hammer and Drill

1" bit capacity for drilling concrete and masonry

Drill concrete anchor holes, thru holes, piping and mechanical openings for construction and repair work. Switches to rotary drilling mode for steel and wood.



Hydraulic Model 2 2426 0010
SDS Plus

SAE #8 oil port

Closed Center Flow Control Valve

Optional accessory – Part No. 38632



SDS Drill Bits



Small Masonry Bits
SDS Plus up to 1" dia.



Large Masonry Bits
SDS Max up to 2" dia.

Hydraulic Pressure Reducing Valves

PRV Part No. 2 2406 9700 reduces output pressure of standard hydraulic power units from 2000 PSI (140 bar) to 1160 PSI (80 bar). Included with SDS Plus Hydraulic Hammer Drill 2 2426 0010 and SDS Max Hydraulic Hammer Drill 2 2418 0020.

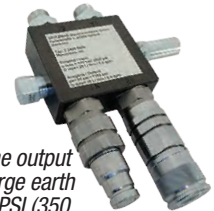

Pressure Reducing Valve Part No. 2 2406 9900 reduces the output pressure of larger-output hydraulic units (i.e. backhoes, large earth tractors, excavators, service trucks, etc.) from max. 5075 PSI (350 bar) to 1160 PSI (80 bar) working pressure.

Pneumatic Hammer Drill Model No.	Blows/Minute (BPM)	Drill Speed (RPM)	Solid Bit Capacity (concrete)	Core Bit Capacity (concrete)	Twist Drill (wood)	Motor Power (HP)	CFM at 90 PSI	Tool System	Dimensions (inches)	Weight (lbs.)
2 1266 0010*	0-2000	0-950	1/2" dia.	1" dia.	3/8" dia.	0.75	21	1/2" Chuck	12 x 8 1/2 x 4	7
2 2404 0010	0-3000	0-625	1" dia.	3" dia.	3/4" dia.	0.70	21	SDS Plus	16 x 8 1/2 x 4	11
2 2404 0030*	0-3000	0-625	1" dia.	3" dia.	3/4" dia.	0.70	21	SDS Plus	16 x 8 1/2 x 4	11
2 2417 0010*	0-2500	0-250	2" dia.	6" dia.	1 1/4" dia.	1.60	53	SDS Max	19 1/2 x 9.8 x 4 1/2	26

* Underwater model – optional underwater air tool line conditioner to displace moisture, Part No. MS 9105. See page 79.

Hydraulic Hammer Drill Model No.	Blows/Minute (BPM)	Drill Speed (RPM)	Solid Bit Capacity (concrete)	Core Bit Capacity (concrete)	Twist Drill (wood)	Motor Power (HP)	Oil Flow/PSI	Tool System	Dimensions (inches)	Weight (lbs.)
2 2426 0010	0-3400	0-625	1" dia.	3" dia.	3/4" dia.	0.8	5.8-13.2 GPM @ 1160 PSI	SDS Plus	18 x 10 1/4 x 4	15
2 2418 0010	0-2500	0-250	2" dia.	6" dia.	1 1/4" dia.	1.8	2.6-13.2 GPM @ 1160 PSI	SDS Max	16 x 8 1/2 x 4	11
2 2418 0020	Same as 2 2418 0010 above. Includes 2 2406 9700 Pressure Reducing Valve for 2000 PSI.									

* Hydraulic Hammer Drills operate at hydraulic pressures of 1160 PSI max. Pressure reducing valves are available to reduce pressure from 2000 PSI or 5000 PSI. See above. Available with optional closed center.

SDS ROTARY HAMMER DRILLS

Woodboring Air Drills, Reversible

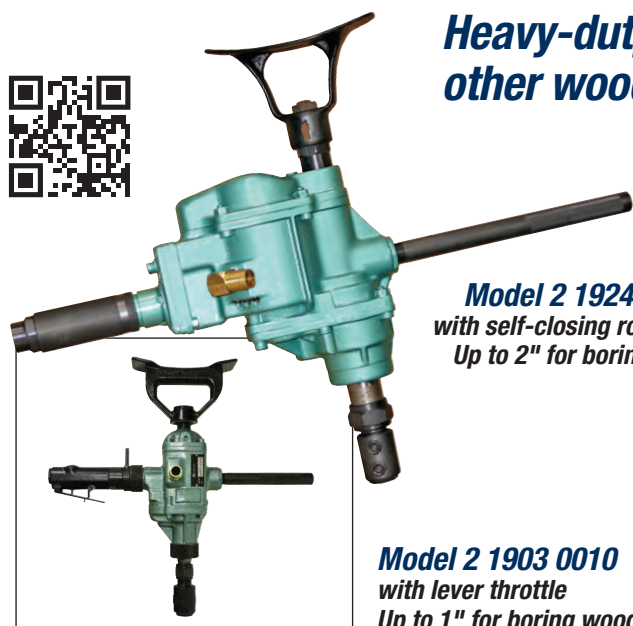

Heavy-duty power for underwater drilling and other wood boring applications



Model 2 1924 0010
with self-closing roll throttle
Up to 2" for boring wood

Model 2 1903 0010
with lever throttle
Up to 1" for boring wood

- Ideal for drilling wood in marine timbers, underwater use and railroad repair work
- Thrust bearing support for long life and efficient operation
- Lever throttle and durable spur gearing
- Breast plate and dead handle included
- Includes threaded exhaust port
- Use underwater with Air Tool Line Conditioner (shown below)

Accessories and woodboring drill bits from 1/2" dia. to 1 1/8" dia. in lengths from 12" to 36"

Specifications	Model 2 1903 0010	Model 2 1924 0010	Model 2 1924 0010
Capacity in Wood	1" Diameter	2" Diameter	3" Diameter
Reversible	Yes	Yes	Yes
Power	2 HP	3 HP	3 HP
Chuck Style	1/2" Woodboring	1/2" Woodboring	1/2" Woodboring
Spindle	Stub Taper	#2 Morse Taper	#3 Morse Taper
Free Speed	750 RPM	700 RPM	380 RPM
Recommended Hose Size	1/2"	1/2"	1/2"
Overall Height	17 1/2"	18 1/2"	18 1/2"
Weight	14 1/2" lbs.	24 3/4" lbs.	24 3/4" lbs.
Air Inlet Thread	1/2" ID	1/2" ID	1/2" ID
Air Exhaust Thread	1/2" NPT	1/2" NPT	1/2" NPT
Air Consumption at 90 PSI	39 CFM	39 CFM	39 CFM
Optional Geared Drill Chuck	Part No. DE-99C	Part No. IBC 22 (MT2)	Part No. IBC 21 (MT3)

AirPac Extends life of pneumatic power tools



Model CSAP-2

- Eliminates air motor downtime caused by water and dirt
- Connections for two tools; max. air flow 185 CFM

- Removes moisture and dirt from air lines; a float valve automatically ejects water and dirt
- Includes automatic oiler; prevents tools from freezing in cold environments

Air Tool Line Conditioner

Underwater air tool conditioner for marine applications. Displaces moisture and inhibits rust/corrosion of air motors.

MS 9105 – 1 quart/liter



Nut Runners - High Torque

ATEX

Pneumatic and hydraulic: ideal for turning valves, tightening, tapping, reaming, pipe beveling, expanding and more



- Worm gear drive provides high torque – up to 554 ft.-lbs.
- Lightweight and reversible
- Compact angle head allows access to confined spaces



Available with Male or Female Square Drives, in a variety of sizes



Male Sq. Drive Head
1/2" or 3/4"



Female Sq. Drive Head
3/4" or 7/8"

Model numbers pictured above (listed from top to bottom): **6 1055 0075** (with male drive), **6 1055 0010** (female), **6 1014 0075** (with male drive)

Square Drive Accessories

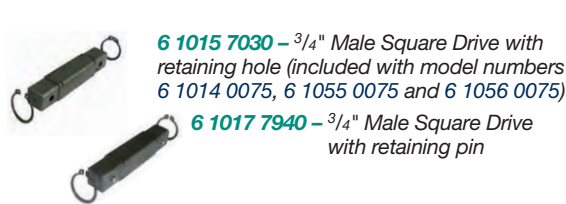

6 1015 7030 – 3/4" Male Square Drive with retaining hole (included with model numbers 6 1014 0075, 6 1055 0075 and 6 1056 0075)

6 1017 7940 – 3/4" Male Square Drive with retaining pin



6 1018 7940 – 1/2" Male Square Drive with retaining pin (included with model numbers 6 1014 0099, 6 1055 0099 and 6 1056 0099)

6 1016 7940 – 1" Male Square Drive

Pneumatic Nut Runner Model No.	Square Drive F=Female M=Male	Stall Torque at 90 PSI (ft.-lbs.)	Free Speed (RPM)	Load Speed (RPM)	Power (HP)	CFM at 90 PSI	Side to Center Distance	Length	Weight (lbs.)	Air Connection	Hose ID
6 1014 0075*	3/4" M	95	200	100	0.9	46	1"	22"	11	3/8" NPT	1/2"
6 1014 0099	1/2" M	95	200	100	0.9	46	1"	22"	11	3/8" NPT	1/2"
6 1055 0075*	3/4" M	405	40	22	0.9	46	1"	21"	10	3/8" NPT	1/2"
6 1055 0099	1/2" M	405	40	22	0.9	46	1"	21"	10	3/8" NPT	1/2"
6 1056 0075*	3/4" M	133	120	67	0.9	46	1"	21"	11	3/8" NPT	1/2"
6 1056 0099	1/2" M	133	120	67	0.9	46	1"	21"	11	3/8" NPT	1/2"
6 1057 0075*	3/4" M	73.5	250	125	0.9	46	1"	21"	11	3/8" NPT	1/2"
6 1057 0099	1/2" M	73.5	250	125	0.9	46	1"	21"	11	3/8" NPT	1/2"
6 1061 0010	7/8" F	405	40	22	0.9	46	1"	21"	11	3/8" NPT	1/2"

* Also available with 3/4" Female Square Drive – use 0010 instead of 0075 in model number.

Hydraulic Nut Runner Model No.	Square Drive F=Female M=Male	Drive Torque (ft.-lbs.)	Free Speed (RPM)	Load Speed (RPM)	Power (HP)	Oil Flow (GPM)	Oil Pressure (PSI)	Side to Center Distance	Length	Weight (lbs.)	Connection Quick Couplers
3 6242 0010*	3/4" F	369	40	22	1.6	4-13	90-2000	1"	20"	22	1/2" FF
3 6243 0010*	3/4" F	125	180	90	1.6	4-13	1300-2000	1"	20"	22	1/2" FF

* Also available with 1/2" (3 6242 0099) and 3/4" (3 6242 0075) Male Square Drive

ATEX Directive

ATEX classified power tools ensure a high level of safety in explosive atmospheres

ATEX Directive 94/9/EC defines requirements for controlling explosive atmospheres, as well as the standards for the equipment used in them. An explosive atmosphere is an atmosphere where enough flammable gas, mist, vapor or dust is mixed with air to cause an explosion if ignition occurs.

What is ATEX?

ATEX (ATmospheres EXplosibles) is a directive for those who design, manufacture or sell any equipment intended for use in potentially explosive atmospheres. Technical and quality objectives must be certified by a third-party certification association. The ATEX directive has been a legal requirement for all European Union States since July 2003. The ATEX symbol is recognized internationally, providing assurance to users around the world that the product was manufactured to high levels of safety.

How are ATEX tools classified?

Five elements are used to ensure that a specific piece of equipment is appropriate for its intended purpose and can be safely used in a particular application. These five elements are: 1. Industrial or Mining Application; 2. Equipment Category; 3. Atmosphere; 4. Gas; and 5. Temperature (see chart below).

What types of tools receive ATEX certification?

Pneumatic, hydraulic and electric power tools for construction and industry can be ATEX certified. CS Unitec offers a comprehensive line of power tools for the oil, gas and energy industries. ATEX certified power tools from our line include select models of reciprocating saws, hacksaws, rotary hammer drills, impact wrenches, portable band saws, nut runners, magnetic drills, axial fans and more.

How can I tell if my tool is ATEX certified?

The tool will be marked with the appropriate ATEX classification label and Ex symbol .

Equipment Group	Equipment Category	Atmosphere	Gas Groups	Temperature <i>(tool surface temp. does not exceed)</i>
II Surface Industry	1 Very High Level of Protection <i>[Zone 0, 1, 2 or 20, 21, 22]</i>	Gc Atmosphere Containing Gas, Vapors or Mist	IIA Propane (acetone, petroleum fuel, ammonia, ethane, methanol, carbon monoxide, propane, n-butane, ethanol, diesel fuel, kerosene, avgas fuel, ethyl nitrite)	T1 842°F/450°C
	2 High Level of Protection <i>[Zone 1, 2 or 21, 22]</i>	Dc Atmosphere Containing Dust		T2 572°F/300°C
	3 Normal Level of Protection <i>[Zone 2 or 22]</i>			T3 392°F/200°C
IM Mining Applications (underground and above-ground facilities)			IIB* Ethylene (coal gas, ethylene, ethyl oxide, hydrogen sulphide) <small>* IIA and IIB are in increasing order of sensitivity to ignition sources, so equipment designed for use in IIB is also safe to use in IIA.</small>	T4 275°F/135°C
				T5 212°F/100°C
				T6 185°F/85°C

CAUTION: The user is responsible for following all safety regulations (OSHA, etc.) when choosing the appropriate tool for the hazards present.

For ATEX information, visit: <http://ec.europa.eu/growth/sectors/mechanical-engineering/atex/>

For more information and product specifications on CS Unitec's ATEX classified industrial power tools, call 1-800-700-5919 (203-853-9522 international) or email info@csunitec.com.

For a FREE poster explaining Ex zones, visit www.csunitec.com/poster.

Tool Classification Examples:

Industry with explosion group for specified types of gas:

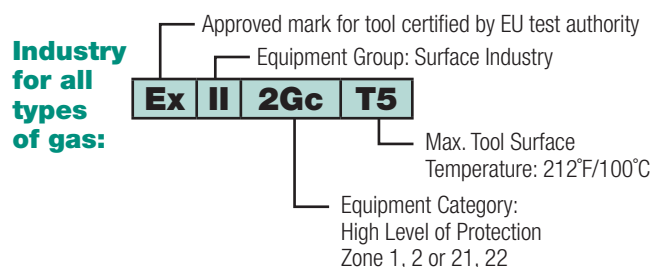
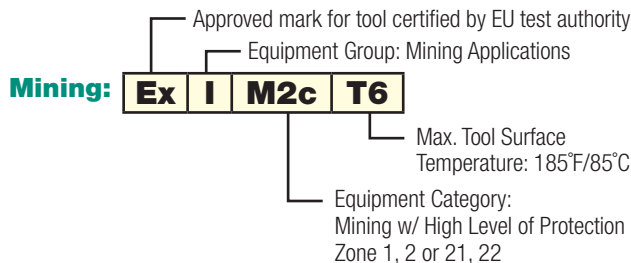
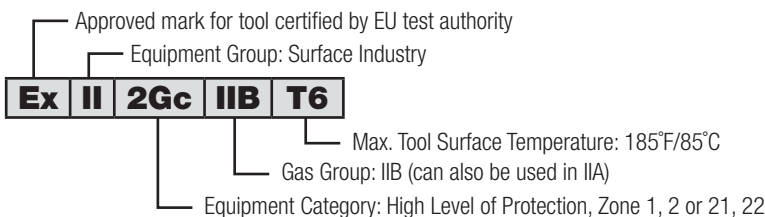

For a complete list of CS Unitec's ATEX tools, visit: www.csunitec.com/specialty/atex-power-tools

UNITEC Surface Finishing Tools & Accessories

The value is in the engineering... the payback is in the performance.™

CS Unitec offers professional power tools and abrasive accessories for surface finishing on **STEEL, STAINLESS STEEL, ALUMINUM** and other metals, as well as rigid plastics and wood.

Innovation is the engine of efficiency!™

Innovations in machine design, abrasive materials and production methods have led the way to:



Hollow-core abrasives for linear grinding

The PTX Eco Smart is a linear surface finishing machine with a finned shaft for quick abrasive changing – simply slide on the abrasives and they secure automatically. This saves time and the abrasive wheels cost less. (Patented!)

Belts with buttonhole fastening system for grinding and polishing closed pipe constructions. (Patented!)



5/8"-11 SPEED NUT changeover

The **EASY-LOCK SPEED NUT** allows you to change flap discs in seconds, without tools. It is easily hand tightened and eliminates the need for wrenches or expensive hubs. (Patented!)

Important advancements in flap disc technology

- PLANTEX® high-tech hemp fiber compound (Patented!)
- POLY-MAGIC-WHEEL for dry polishing inside corners
- MAGNUM® FLEECE TOP for surface conditioning, fine finishing and polishing



Hemp fiber is an almost ideal base material for backing plates of flap discs... and it is a renewable resource!

Safer and more efficient!

CS Unitec is the source for flap discs and abrasives that are free of fiberglass, mineral fibers and epoxy resin. They offer superior material removal, longer service life and smoother ergonomic handling.

Better for the environment!

The fiber in the high-tech PLANTEX® compound is derived from the hemp plant – a sustainable raw material which counteracts greenhouse emissions as it grows. The PTX hollow-core abrasives not only improve production efficiencies, but also minimize pollution from production to waste disposal... no plastic insert!

Better for your bottom line!

In addition to their time-saving features and high quality, flap discs and abrasives from CS Unitec can save you money – their cost of production is lower, their quality is among the best and they offer superior service life. Hollow-core abrasive wheels from CS Unitec are more affordable than traditional solid-core abrasives since they can be produced from less raw material. These new hollow-core abrasive wheels can also be used on traditional finishing machines with the aid of a simple core adapter (see page 85).



View product demonstrations at www.csunitec.com.

Surface Finishing Tools and Abrasives Index:

Surface Finishers		p. 84-91
PTX Eco Smart – electric		p. 84-86
Abrasives, Belts, Brushes, Grinding Wheels, etc.		p. 87-91
Multipurpose Grinders		p. 92-93
MULTI-MAX Stationary Multipurpose Grinder		p. 92-93
Flexible Shaft - flexible drive shaft for use with VARILEX® and MULTI-MAX		p. 93
All-in-One Angle Grinder/Finishing, Blending & Polishing Machine		p. 94-95
VARILEX® Speed-controlled Grinder/Finisher/Polisher – 4" to 7" diameter		p. 94-95
Flap Discs and Abrasives for Grinding, Blending and Finishing		p. 96-109
PLANTEX® SUNFIRE – for high performance on all metals		p. 100-101
PLANTEX® UNIVERSAL – for blending stainless steel		p. 102
PLANTEX® CERAMIC – for ALL METALS		p. 103
PLANTEX® COOL TOP® – for stainless steel		p. 102
PLANTEX® TIGER SHARK® – for blending aluminum		p. 104
FIX HOOK & LOOP SYSTEM – flexible backing disc for finishing		p. 105-107
POLY-MAGIC-WHEEL – for dry polishing in corners		p. 108
MAGNUM® TOPMIX – for increased material removal		p. 108
MAGNUM® FLEECE TOP – for conditioning, finishing and polishing		p. 109
MAGNUM® CLEAN – for pore-deep cleaning of metals		p. 109
Pipe Sanders and Multifunctional Grinders		p. 110-111
PIPE-MAX – weld seam grinder and pipe sander		p. 110
GLADIUS® 1800 Multifunctional Grinder		p. 111
Deburring, Beveling and Faceting Machines		p. 112-117
Sheet Metal Deburring, Beveling and Faceting Machines		p. 112-115
Portable Beveling Machines		p. 116-117



PTX ECO SMART



PLANTEX®



VARILEX®

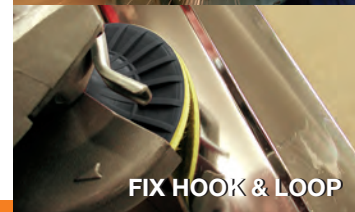

FIX HOOK & LOOP



DEBURRING



BEVELING

Safety Guidelines

Use all products according to the safety regulations of OSHA and directives by ANSI (American National Safety Institute) B7.1, European DIN EN 13743 and all other applicable international safety standards.

PTX ECO SMART

The professional linear finishing system for hard, continuous use.

A revolution in linear grinding! Simply slide on the abrasives and they secure themselves automatically when the machine turns. Fast and easy!

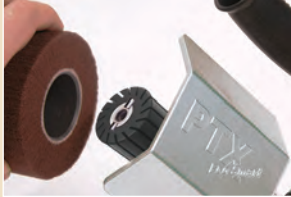
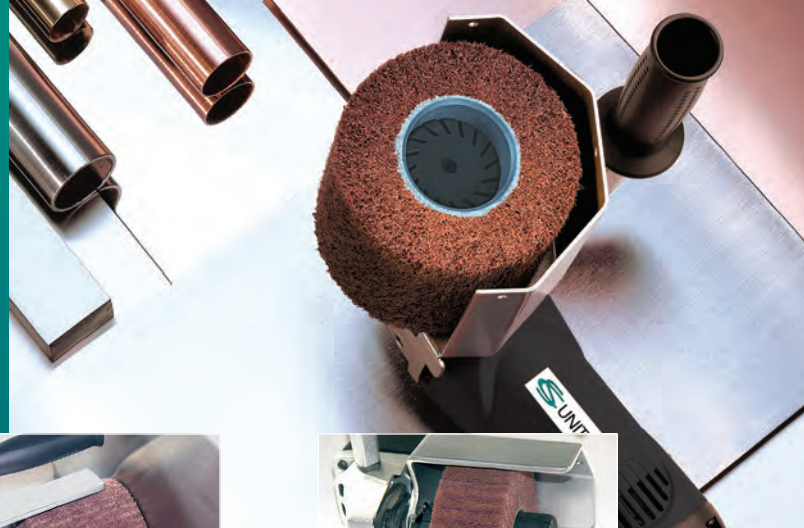

Press the spindle lock and simply slide on the abrasive wheels or brushes, turning in the correct direction onto the finned shaft. They will be secured automatically.



Grinding in corners is easy – simply slide the abrasive wheel on the finned shaft a little towards the outside.



Even narrow abrasive wheels can be used on the PTX Eco Smart and positioned freely on the finned shaft (no spacer rings required).

LINEAR GRINDING SYSTEM



1 Adjustable handle for right and left-handed users. Anti-vibration handle for comfortable, fatigue-free working.



2 Simple speed control during operation. Tachogenerator for stable speeds.



3 QUICK-LOCK cable for fast, easy replacement if cable is damaged. 13 ft., included. **Part Number: 52004-2**



4 Infinitely adjustable cover guard with securing points for the extraction cover. **Part Number: 40005**



5 Extended polycarbonate cover guard for grinding wheel widths up to 6". **Part Number: 52706**



6 Hollow core shaft adapter for roller wheel widths up to 6" and vibration-free operation. **Part Number: 42004**



PTX Eco Smart

110 Volt
or 220 Volt



3

Perfect finishes on large surfaces, with no shadows or streaks.



New abrasive mounting system saves time, reduces cost and eliminates vibration.

PTX Eco Smart is a multi-functional grinding and polishing system for flat surfaces and open or closed pipe constructions.

- Grind from coarse to shadow-free matte finish, up to a mirror polish
- Remove welds, deep scratches, oxidation and rust
- Ideal for stainless steel, steel and nonferrous metals including aluminum, brass, bronze and copper, as well as wood and rigid plastic
- Complete line of grinding wheels, belt sleeves, special brushes, polishing and maintenance abrasives available
- Balanced straight-line handling, high torque and electronic speed control
- Abrasive mounting system allows quick changeover, vibration-free operation and 100% concentricity
- Core-free abrasives save money and produce less waste



Satin finishing using interleaf fleece wheel.



A wide selection of hollow-core abrasives is available for the PTX Eco Smart. The lack of a core insert means that the abrasives are lighter, easier to use and less expensive.

NOTE: We do continue to carry abrasives with core insert adapters for older LP 1503 VR model grinders and other machines. Contact us for more information.

PTX Eco Smart Specifications

Order No.	PTX ECO SMART	
Motor Power	15 Amp (1710 Watts); 110 Volt/60Hz (Also available: 230 Volt / 50 Hz)	
Speed Control Dial	Variable speed control from 1000 to 3800 RPM with tachogenerator for constant speed, even under load	
Wheel Width	2", 4" or 6" wide abrasives	
Wheel Diameter	up to 4 ¹ / ₂ "	
Weight	7.25 lbs.	
Standard Equipment	4" Interleaf (combi) wheel – P/N 47312 Shaft Adapter – P/N 42004	



A range of professional PTX Eco Smart kits is available for a variety of applications. See page 86 for more information.

Accessories



Hollow-core Shaft Adapter

Allows user to utilize more economical hollow-core abrasives on traditional surface finishers. Fits 3/4" dia. x 4" long shaft and 1/4" keyway(s). Overall diameter of adapter is 1-3/4" (45mm)
Part Number: 42004

The PTX Bench Grinder – MULTI-MAX

Multipurpose sander with two shaft mountings for grinding discs, angle grinders and grinding rollers for longitudinal grinders. Uses all PTX abrasive wheels and discs. (See page 92 for more details.)



PTX Eco Smart Kits

PTX Professional Kit For Metalworking

This set comes in a strong, impact-resistant transport case and contains everything you need for shadow-free industrial finishes. Match or create any finish up to a mirror finish on metals. Prevent marks and fingerprints with newly developed cleaning products and preservatives.

Part Number 47004A



PTX Professional Kit for Metalworking includes:

- 1 PTX Eco Smart machine
- 1 Professional Case (P/N 80002)
- 1 40 grit flap wheel, 4" x 4-1/8" (P/N 47211)
- 1 80 grit Interleaf (Combi) wheel, 4" x 4-1/8" (P/N 47312)
- 1 Expansion roller, 3-1/2" x 4" (P/N 47005)
- 2 80 grit grinding belt sleeve, 3-1/2" x 4" (P/N 42080)
- 1 Fine fleece (Nonwoven) sleeve, 3-1/2" x 4" (P/N 42012)
- 1 Medium fleece (Nonwoven) sleeve, 3-1/2" x 4" (P/N 42011)
- 2 A45 TZ Pyramid sleeves, 3-1/2" x 4" (P/N 42245)
- 2 A30 TZ Pyramid sleeves, 3-1/2" x 4" (P/N 42230)
- 2 A16 TZ Pyramid sleeves, 3-1/2" x 4" (P/N 42216)
- 2 A06 TZ Pyramid sleeves, 3-1/2" x 4" (P/N 42206)
- 3 SuperPolish sleeves, 3-1/2" x 4" (P/N 42013N)
- 1 Belt driving roller (P/N 47006)
- 2 80 grit grinding belts, 1.2" x 24" (P/N 49080)
- 1 Medium fleece (Nonwoven) belt, 1.2" x 26" (P/N 49002)
- 2 A45 TZ Pyramid belts, 1.2" x 24" (P/N 49345)
- 2 A30 TZ Pyramid belts, 1.2" x 24" (P/N 49330)
- 2 A16 TZ Pyramid belts, 1.2" x 24" (P/N 49316)
- 2 A06 TZ Pyramid belts, 1.2" x 24" (P/N 49306)
- 3 SuperPolish belts, 1.2" x 26" (P/N 49004N)
- 1 Mini high gloss polishing paste, pink (P/N 40015T)
- 2 Mini polishing pastes, white and blue [P/N 40013 (white) P/N 40014 (blue)]
- 1 PTX Brightex® scatter can (P/N 40029)
- 5 Microfiber cloths (P/N 40031)
- 1 Brilliance-Clean spray bottle (P/N 40050)
- 1 INOX-Protect spray bottle (P/N 40040)

PTX Basic Kit for Metal

Basic set for coarse finishing to #4 finish on flat surfaces and pipes.

Part Number 47003A

PTX Basic Kit for Metal includes:

- 1 PTX Eco Smart machine
- 1 Carrying Case (P/N 40008)
- 1 60 grit flap wheel, 4" x 4-1/8" (P/N 47212)
- 1 80 grit Interleaf (Combi) wheel, 4" x 4-1/8" (P/N 47312)
- 1 Expansion roller, 3-1/2" x 4" (P/N 47005)
- 1 Medium fleece (Nonwoven) sleeve, 3-1/2" x 4" (P/N 42011)
- 1 Belt driving roller (P/N 47006)
- 1 80 grit grinding belt, 1.2" x 24" (P/N 49080)
- 1 Medium fleece (Nonwoven) belt, 1.2" x 26" (P/N 49002)
- 1 40 grit grinding belt, 3.6" x 4" (P/N 42040)
- 1 60 grit grinding belt, 3.6" x 4" (P/N 42060)
- 1 80 grit grinding belt, 3.6" x 4" (P/N 42080)
- 1 120 grit grinding belt, 3.6" x 4" (P/N 42120)



PTX Kit For Woodworking

The complete set for treating wooden surfaces. Strong transport case with PTX Eco Smart and a range of brush wheels for various wood structures. Suction cover for extracting grinding dust particles.

Part Number 40004-3A

PTX Basic Kit for Woodworking includes:

- 1 PTX Eco Smart machine
- 1 Carrying Case (P/N 40008)
- 1 Suction cover (P/N 40005)
- 1 Spacer ring (P/N 40007)
- 1 PTX stranded wire wheel (P/N 46301)
- 1 Bristle wheel (P/N 46101)
- 1 Fiber wheel (P/N 46400)



PTX Grinding Wheels for Coarse and Fine Finishing

PTX abrasives from CS Unitec are made according to high quality standards. A unique production process guarantees high concentricity for vibration-free grinding – ideal for fatigue-free working and perfect surface finishes with no transitions or shadows. **Simply try it!** You will be surprised how much smoother a PTX grinding wheel or brush wheel is.



PTX FLEECE (Nonwoven) Wheel

Flexible nylon fleece impregnated with abrasives for a first-class finish. Produces shadow-free matte, satin and polished finishes. For removing oxidation on stainless steel and nonferrous metals and also suitable for smoothing wooden surfaces. Very high fleece content by fleece compression.

Diameter: 4"
Width: 2", 4-1/8" or 6"
Grit: 60, 80, 180, 280, 400, 600



PTX Interleaf (Combi) Wheel

Nylon fleece combined with abrasive flaps for matte finishing, burnishing and removing light scratches, oxidation and handling marks on stainless steel and all metals. For removing old paint on wood while smoothing at the same time.

Diameter: 4"
Width: 2", 4-1/8" or 6"
Grit: 60, 80, 180



PTX Flap Wheel

With radial abrasive cloth flaps in various grit sizes for removing rust, oxidation layers, minor scratches and for the regraining and burnishing of metals.

Diameter: 4"
Width: 2" or 4-1/8"
Grit: 24, 40, 50, 60, 80, 120, 180, 240



PTX CLEAN Wheel

Made of hard-textured, nonwoven fleece for cleaning and descaling welds, pore-deep removal of rust, oxidation and coatings, cleaning beams, bricks, etc. Produces an effective linear finish on stainless steel.

Diameter: 4"
Width: 2" or 4"
Grit: Medium



PTX GUM Wheel

Soft rubber impregnated with abrasive grit for the removal of minor scratches. Ideal for a bright, decorative linear finish on stainless steel and nonferrous metals and for smoothing wooden fibers.

Diameter: 4"
Width: 2" or 4"
Grit: 60, 180

HOLLOW-CORE ABRASIVES HAVE MANY ADVANTAGES:

- Easy to mount – simply slide on and off
- 100% concentricity – no vibration
- Lower cost and higher productivity!

We continue to carry abrasives with core inserts.
Contact us for more information.

PTX Fleece Nonwoven Wheels

Part No.	Grit	Size (dia. x width)
47411	60	4" x 4 1/8"
47412	80	4" x 4 1/8"
47413	180	4" x 4 1/8"
47414	280	4" x 4 1/8"
47415	400	4" x 4 1/8"
43601*	600	4" x 4 1/8"
47401	60	4" x 2"
47402	80	4" x 2"
47403	180	4" x 2"
47404	280	4" x 2"
47405	400	4" x 2"
47422	80	4" x 6"
47423	180	4" x 6"

* Keyed shaft

PTX Interleaf (Combi) Wheels

Part No.	Grit	Size (dia. x width)
47311	60	4" x 4 1/8"
47312	80	4" x 4 1/8"
47313	180	4" x 4 1/8"
47301	60	4" x 2"
47302	80	4" x 2"
47303	180	4" x 2"
47322	80	4" x 6"
47323	180	4" x 6"

PTX Flap Wheels

Part No.	Grit	Size (dia. x width)
47211	40	4" x 4 1/8"
47212	60	4" x 4 1/8"
47213	80	4" x 4 1/8"
47214	120	4" x 4 1/8"
47215	180	4" x 4 1/8"
47201	24	4" x 2"
47202	40	4" x 2"
47204	60	4" x 2"
47205	80	4" x 2"
47206	120	4" x 2"
47207	180	4" x 2"
47208*	240	4" x 2"

* Keyed shaft

PTX CLEAN Wheels

Part No.	Grit	Size (dia. x width)
47511	Medium (black)	4" x 4"
40018A*	Medium (black)	4" x 2"

* Keyed shaft

PTX GUM Wheels

Part No.	Grit	Size (dia. x width)
45061*	60	4" x 4 1/8"
45181*	180	4" x 4 1/8"
45180*	180	4" x 2"

* Keyed shaft



Expansion Roller

Use with sanding belts, fleece and felt sleeves. The sleeves are simply pushed over the expansion roller and held securely in place by the centrifugal force. **3-1/2" dia. x 4" wide – Part Number: 47005**

TIPS & TRICKS

Expansion Roller – Hard Rubber

Internal expansion slots now allow easier sleeve replacement and improved adjustment to the workpiece, as well as vibration absorption and concentricity.

Part Number: 47005



Belt Sleeves for Expansion Roller

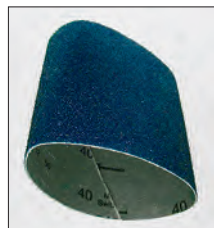

PTX Zirconium Grinding Belt Sleeve

Made of zirconium. Removes deep scratches and grinds weld seams on metals. Far less rework is required as a result of using the time-saving linear grinding technique.

3-1/2" dia. x 4" wide
Grit: 40, 60, 80, 120, 150, 180



PTX Ceramic Grinding Belt Sleeve

High-performance ceramic aluminum oxide grain. Increased removal rate and longest life for highest productivity. Excels in all metals.

3-1/2" dia. x 4" wide
Grit: 40, 60, 80

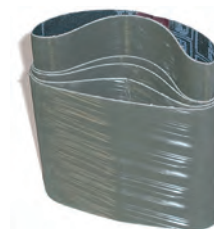

PTX TZ Pyramid Sleeve

New abrasive cloth with pyramid-shaped grit structure. High material removal while producing a very fine finish, reducing the amount of work required when compared to grinding belt sleeves and fleece sleeves. Ideal for pre-polishing for fine mirror finishes and removing scratches and spot welds.

Even roller scale can be removed easily.

3-1/2" dia. x 4" wide
Grit: A65/320, A45/400, A30/600, A16/1200, A06/2000



PTX Fleece "Nonwoven" Sleeve

Nylon impregnated with abrasive grit for removing minor to medium scratch marks and oxidation coatings, matte and satin finishing and deburring applications.

3-1/2" dia. x 4" wide
Grit: Coarse, Medium, Fine, Superfine

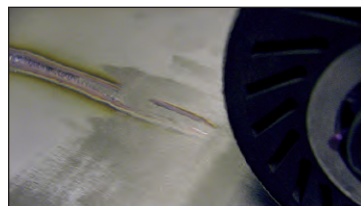

The expansion roller is helpful when grinding large areas and removing large welds.

PTX Zirconium Grinding Belt Sleeves

Part No.	Grit	Size (dia. x w)	Quantity
42040	40	3 1/2" x 4"	10 per pack
42060	60	3 1/2" x 4"	10 per pack
42080	80	3 1/2" x 4"	10 per pack
42120	120	3 1/2" x 4"	10 per pack
42150	150	3 1/2" x 4"	10 per pack
42180	180	3 1/2" x 4"	10 per pack

PTX Ceramic Grinding Belt Sleeves

Part No.	Grit	Size (dia. x w)	Quantity
42440	40	3 1/2" x 4"	10 per pack
42460	60	3 1/2" x 4"	10 per pack
42480	80	3 1/2" x 4"	10 per pack

PTX TZ Pyramid Sleeves

Part No.	Grit	Size (dia. x w)	Quantity
42270	A100/220	3 1/2" x 4"	10 per pack
42265	A65/320	3 1/2" x 4"	10 per pack
42245	A45/400	3 1/2" x 4"	10 per pack
42230	A30/600	3 1/2" x 4"	10 per pack
42216	A16/1200	3 1/2" x 4"	10 per pack
42206	A06/2000	3 1/2" x 4"	10 per pack

TZ PYRAMID GRIT COMPARISON TABLE

Corresponds to grit size	A65	A45	A30	A16	A06
	320	400	600	1200	2000

PTX Fleece "Nonwoven" Sleeves

Part No.	Grit	Size (dia. x w)	Quantity
42010	coarse (brown)	3 1/2" x 4"	4 per pack
42011	medium (red)	3 1/2" x 4"	4 per pack
42012	fine (blue)	3 1/2" x 4"	4 per pack
42009	superfine (grey)	3 1/2" x 4"	4 per pack

FLEECE COMPARISON TABLE

Corresponds to grit size	Coarse (brown)	Medium (red)	Fine (blue)	Superfine (grey)
	80	180	280	400

TIPS & TRICKS



To remove the grinding sleeve, place the expansion roller on a round object that is slightly smaller than the roller. Then push the sleeve down slightly using both hands.

Special Brushes for Metals, Wood and Hard Plastics



PTX Stranded Wire Wheels
Sturdy steel wire brush. For deburring, rust removal, roughing and cleaning metal. For brushing out soft annual rings on timber, leaving a rough rustic effect.
4" dia. x 2-7/8" wide – **Part No. 46301***
4" dia. x 1" wide – **Part No. 47702***
* Requires spacer ring 40007



PTX Bristle Wheel
Elastic nylon brush impregnated with abrasive grit. For roughing and deburring metal, as well as creating a rustic effect with even annual ring transitions on timber.
4" dia. x 2-7/8" wide – **Part No. 46101***
4" dia. x 1" wide – **Part No. 46102N***
* Requires spacer ring 40007



PTX Stainless Steel Wire Wheels
Elastic stainless steel wire brush. For cleaning welds, deburring, removing rust, roughing and removing coatings.
4" dia. x 2-7/8" wide – **Part No. 47721***
4" dia. x 1" wide – **Part No. 46202N***
* Requires spacer ring 40007



PTX Fiber Wheel
Elastic fiber brush. For polishing stained wood, satin finishing, pore-deep dust removal and cleaning applications.
4" dia. x 4" wide – **Part No. 46400**

Note: Above wheels are configured for keyed shaft. Hollow-core shaft adapter not necessary.



Stranded wire wheel for creating a rustic effect on wood



Cotton Buffing Wheel
Cotton yarn wheel for use with compounds. Produces a very bright high mirror finish. Use on flat, contoured or irregular surfaces.



4" dia. x 2" wide
Part No. CS 2405*
4" dia. x 4" wide
Part No. CS 2410
4" dia. x 6" wide
Part No. CS 2420
* Requires spacer ring 40007

Abrasives for Polishing to High-Gloss and Mirror Finish



PTX Felt Sleeve
Made of soft merino (endless) for polishing large stainless steel and nonferrous surfaces quickly to a mirror finish. Also suitable for hard plastics. Must be used with the expansion roller.
3-1/2" dia. x 4" wide (4 per pack)
Part No. 42013



PTX SuperPolish Sleeve
Revolutionary special fleece produces perfect brilliant, shadow-free mirror finishes on stainless steel and nonferrous metal surfaces using polishing compounds (white and blue) and pink polishing cream. SuperPolish fleece is absorbent, does not smear and saves significant work time. Must be used with the expansion roller.
3-1/2" dia. x 4" wide (4 per pack)
Part No. 42013N



Poly-PTX Cotton Rings
Fleece rings for polishing narrow or uneven stainless steel and nonferrous metal surfaces using polishing compounds (white and blue) and pink polishing cream. A separate Poly-PTX Cotton Ring must be used for each compound or cream so as not to mix different compound grits.
For polishing narrow or uneven stainless steel surfaces:
100mm x 12mm (4" dia. x 1/2" wide), 8 per pack, **Medium Part No. 40019M**
100mm x 12mm (4" dia. x 1/2" wide), 8 per pack, **Soft Part No. 40019-T**
For polishing aluminum, brass and other nonferrous metals:
100mm x 12mm (4" dia. x 1/2" wide)
Part No. 250 521

See page 90 for pre-grinding and polishing compounds, mirror finish creams, cleaners and protective sprays for finished metal surfaces.



Polishing and Maintenance Products (cont'd)



PTX Pre-grinding & Polishing Compound

Essential for polishing all metals, including stainless steel, aluminum, etc.

PTX WHITE pre-polishing compound (23 oz.) – **Part No. 40013**

PTX BLUE finishing compound (23 oz.) – **Part No. 40014**

PTX WHITE and BLUE mini pastes (approx 4.2 oz. ea.) – **Part No. 40009**



PTX Brightex® Softclean Powder (non-caustic)

For removing cream and compound residues. Scatter on the surface and wipe off with a microfiber cloth.

Aluminum scatter container with Brightex® (approx. 7 oz.) – **Part No. 40029**

Bag, 2.2 lbs. – **Part No. 40028**

Scatter container only – **Part No. 40020**



PTX Polishing Cream, Pink

For high reflective finishing. Produces a perfect mirror finish on stainless steel and nonferrous metals when used with the SuperPolish Sleeve or Belt.

Miniature tube, 2 oz. – **Part No. 40015T**

Can, 2.2 lbs. – **Part No. 40015**

Microfiber Cloths

For pore-deep cleaning and even distribution of maintenance products and polishes. Our microfiber cloths produce a top finish on all materials.

Size: 13" x 14", package of 25 – **Part No. 40031**



INOX-Protect (hard sealant)

Protects finished and polished metal surfaces (stainless steel, steel, aluminum, brass, copper, etc.) with a clear, dry adhesive film. Removes fingerprints and other dirt.

Canister (w/ spray bottle), 1.3 gal. – **Part No. 40041**

Spray bottle, 17 oz. – **Part No. 40040**



Brilliance-Clean

For streak- and residue-free cleaning of all surfaces, including stainless steel, steel, aluminum, brass and copper. Brilliance-Clean is not harmful to plastics, wood or coated surfaces. Remove fingerprints, dust, compound residue, minor oil and grease marks and adhesive residue. Evaporates quickly without leaving residue.

Canister (w/ spray bottle), 1.3 gal. – **Part No. 40051**

Spray bottle, 17 oz. – **Part No. 40050**



POLY Protection (oil film)

For cleaning and preserving finished and polished stainless steel and nonferrous metal surfaces. Protects against shadows and finger and water marks for a long time. Spray on and rub off with a microfiber cloth. Produces a darker effect on finished surfaces.

Canister (w/ spray bottle), 1.3 gal. – **Part No. 40012**

Spray bottle, 17 oz. – **Part No. 40011**

TIPS & TRICKS

A perfect mirror finish on stainless steel

The newly developed grinding and polishing system, featuring special **TZ Pyramid** and **SuperPolish** fabrics from CS Unitec, produces a perfect mirror finish quickly and in just a few steps.

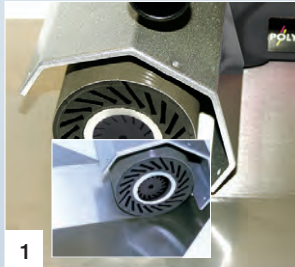

Step 1 - Pre-grinding

Prepare with **TZ Pyramid** sleeve grit A45 (possibly A65) to remove mill skin, scratches and minor unevenness.



Step 2 - Intermediate grinding

Rework with **TZ Pyramid A30** and complete with **TZ Pyramid A16**. Use very little grinding pressure and grind perpendicular and diagonally.

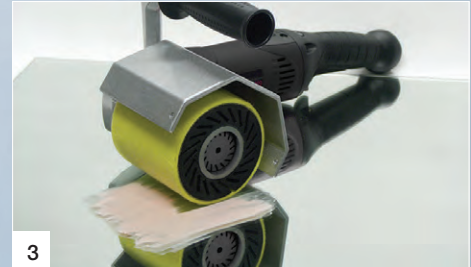

Step 3 - Mirror finish polish

Use the **SuperPolish** sleeve with **white polishing paste**, then with **blue polishing paste**. Use a different sleeve for each paste grit. Polish diagonally. For a high-gloss finish, use the **SuperPolish** sleeve with the **pink high-gloss polishing cream**. Polish in one direction only.

Tip: After each step, remove the compound residue from the workpiece with **PTX Brightex® Softclean Powder** and a microfiber cloth.

The result... a brilliant mirror finish!



Maintain and protect finished or polished stainless steel surfaces.

Compound and cream residues can be removed using **PTX Brightex® Softclean powder**. Simply scatter on the softclean powder and wipe it off using a microfiber cloth.

Compound residues, fingerprints, dust, minor oil and grease marks and adhesive residue can be removed effortlessly with **Brilliance-Clean**. Any residue will evaporate immediately.

To protect finished or polished metal surfaces, spray **INOX-Protect** on the surface, rub off with a microfiber cloth, wipe the surface dry and then polish briefly. The surface will be protected by a dry, invisible film for several weeks. Polished finishes will not be darkened by this product.

Abrasives for Pipe Constructions – Open or Closed

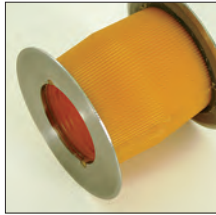

PTX Grinding Belt Roller with stainless steel flanges
For use with grinding, fleece, SuperPolish and felt belts. The belt roller is made of wear-resistant soft Vulculan with stainless steel discs on the sides. The surface is grooved to ensure that the abrasive belt does not slip.
Diameter: 3.5" x 2.8" Part No. 47006

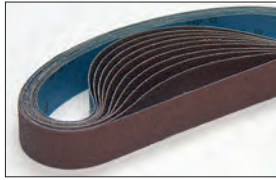

PTX Grinding Belt in high-quality aluminum oxide (closed)
For coarse and initial grinding, rust removal and smoothing round metal pipes. For use with grinding belt rollers. For use on closed pipe constructions, see TIPS & TRICKS below. **Dimensions: 1.2" x 24"**
Grit: 40, 60, 80, 120, 150, 180, 240
See ordering information at right.



PTX TZ Pyramid Belt (closed)
Abrasive fabric with pyramid-shaped grit structure for removing scratches, roller scale and spot welds. TZ Pyramid belts allow high material removal while producing a very fine finish. They are ideal for initial grinding before polishing to a mirror finish. Because grit fineness is increased slowly, it is possible to omit several operations. Use with grinding belt rollers. For use on closed pipe constructions, see TIPS & TRICKS below.
Dimensions: 1.2" x 24", Grit: A65, A45, A30, A16, A06
See ordering information at right.



PTX Fleece Nonwoven Belt (open)
Buttonhole fastening system for fine grinding and pre-polishing open and closed pipe constructions and handrails. The fleece belt can be opened and closed as often as necessary. For use with grinding belt rollers. International patent and design protected.
Dimensions: 1.2" x 26", Grit: coarse, medium, fine, superfine. See ordering information at right.

With buttonhole – **PATENTED!**

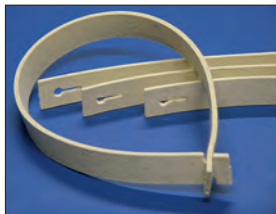

PTX Felt Belt (open)
Made of merino felt with buttonhole fastening system for polishing open and closed pipe constructions and handrails. The polishing belt can be opened and closed as often as necessary. Use with grinding belt rollers and our polishing compounds and creams. Use a separate felt belt for each compound and cream grit - do not mix grits. International patent and design protected.
Dimensions: 1.2" x 26" Part No. 49004



PTX SuperPolish Belt (closed)
For a perfect mirror finish on pipe constructions and handrails. SuperPolish is a new, special micro fleece that produces a perfect, brilliant mirror finish on stainless steel and nonferrous metals. Smears and shadows are eliminated when used with our polishing compounds (white and blue) and pink cream. SuperPolish is absorbent and saves time. Use with grinding belt rollers.
Dimensions: 1.2" x 26" (not available with buttonhole fastening system) Part No. 49004N

PTX Grinding Belts (Aluminum Oxide)

Part No.	Grit	Size (w x l)	Quantity
49040	40	1.2" x 24"	10 per pack
49060	60	1.2" x 24"	10 per pack
49080	80	1.2" x 24"	10 per pack
49120	120	1.2" x 24"	10 per pack
49150	150	1.2" x 24"	10 per pack
49180	180	1.2" x 24"	10 per pack
49240	240	1.2" x 24"	10 per pack

PTX TZ Pyramid Belts

Part No.	Grit	Size (w x l)	Quantity
49365	A65/320	1.2" x 24"	10 per pack
49345	A45/400	1.2" x 24"	10 per pack
49330	A30/600	1.2" x 24"	10 per pack
49316	A16/1200	1.2" x 24"	10 per pack
49306	A06/2000	1.2" x 24"	10 per pack

PTX Fleece Nonwoven Belts (open)*

Part No.	Grit	Size (w x l)	Qty.
49001	coarse (brown)	1.2" x 26"	1
49002	medium (red)	1.2" x 26"	1
49003	fine (blue)	1.2" x 26"	1
49007	superfine (grey)	1.2" x 26"	1

* Feature buttonhole fastening system

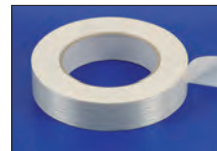

PTX Special Adhesive Tape
Integrated glass fabric for joining grinding belts. Strong, heat-resistant adhesive. Join PTX grinding and TZ Pyramid belts for use on closed pipe constructions. Wrap tape around

entire length of grinding belt, overlapping approximately 370°.
Dimensions: 1" x 165' Part No. 49000



INOX Miter Tape
Protect adjacent finishes when grinding. Self-adhering 304 Stainless tape for use when creating distinct edges on finishes. Excellent for creating mitered corners. Easily cut with scissors, fast application and residue-free removal.

Minimal thickness for accurate grinding lines.
Dimensions: One roll measures 6" x 8.2 ft. Part No. 40070

TIPS & TRICKS

Grinding and polishing closed pipe constructions

Fleece and felt belts with the patented buttonhole fastening system are ideal for working on closed pipe constructions and handrails. The grinding belt can be placed over the pipe and closed or opened again in a twist using the buttonhole system. Changing a belt is quick and easy. The belt can be opened and closed as often as required.

Closed belts such as the high-quality aluminum oxide belt or the TZ Pyramid belt must be cut open to work on closed pipe constructions. Place the belt over the pipe and join using our special adhesive tape (P/N 49000) over the entire length (approx. 370°).



MULTI-MAX

Stationary multipurpose grinder for all workshop grinding, blending and finishing jobs.

Uses all PTX abrasive wheels and discs with 5/8"-11 UNC threads or 7/8" arbor.

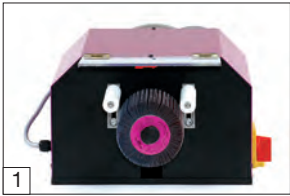
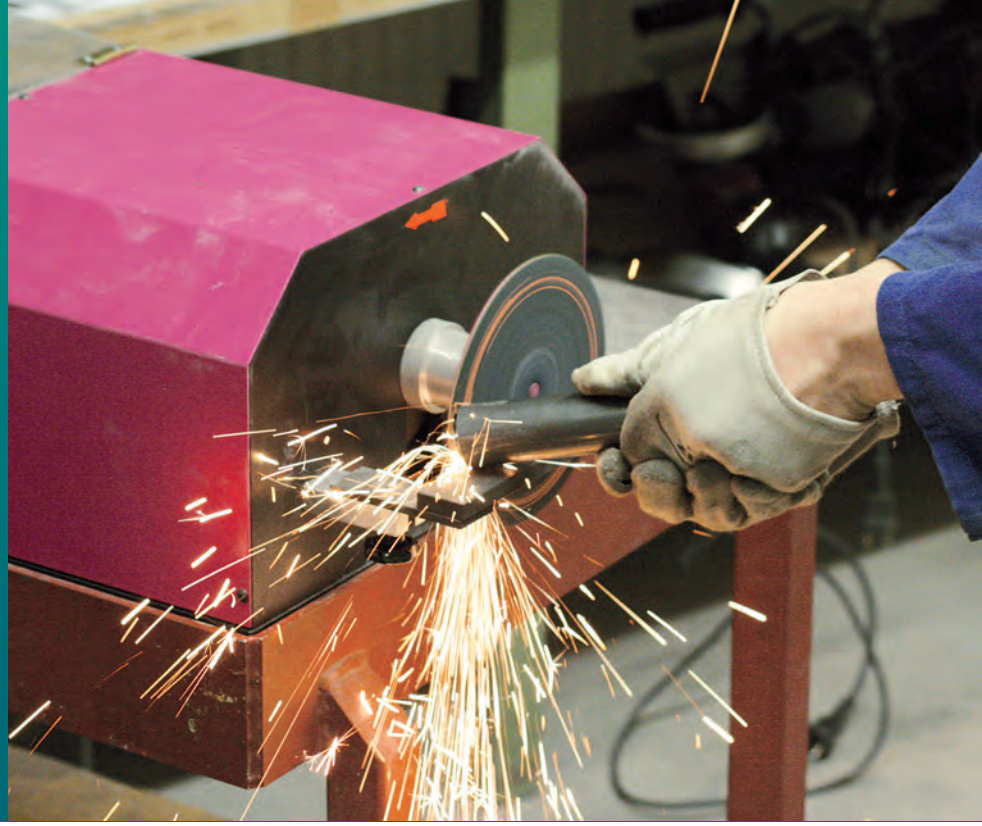

1 Shaft mounting for all abrasives from the PTX ECO SMART system. (See page 84-90)

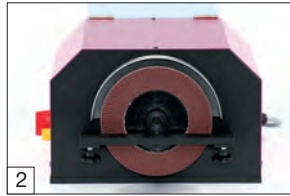

2 5/8"-11 UNC spindle thread for grinding discs or a 7/8" arbor.



3 Uses the FIX HOOK AND LOOP SYSTEM (See pages 105-107). For replacement flap discs, see page 93.



4 Compatible with the new flexible shaft attachment. (See page 93)

Extensive selection of accessories
(See pages 86-90 & 105-107)



Uses all PTX abrasive wheels and discs



MULTI-MAX
220 - 240V, 3-phase
Part No. 30402

MULTI-MAX

A versatile bench grinder

- Two shaft mountings. – uses grinding discs with 5/8"-11 UNC or 7/8" mounting and abrasive grinding wheels for longitudinal surface finishers
- Fast deburring, trimming, grinding, brushing and more
- Uses Poly-PTX grinding wheels for longitudinal grinding, satin finishing, etc. (See page 84-90)
- Uses FIX HOOK & LOOP system for plain grinding, fine grinding and more (see pages 105-107)
- Powerful 3-phase, 750 watt AC motor, 220 volt
- Transparent, hinged grinding guard
- Roller support for more accurate work
- Adjustable support rail with safety hood for grinding discs up to 7"
- Drive motor can be used with the flexible shaft for grinding in narrow and awkward spots (see right)
- For a safe, upright working position, use with the MULTI-MAX machine stand (P/N 30420)



MULTI-MAX Specifications

Order No.	30402
Power	220-240V, 3-Phase
Speed	2,800 RPM
Abrasives	4" to 7" dia.
Disc Mounting	5/8"-11 UNC or 7/8" arbor
Wheel Mounting	Hollow core or Keyway
Weight	5.2 lbs.
Standard Equipment	Multi-Max Tool, 220V PTX Flap Wheel, 80 grit (2 P/N 41080) PTX Interleaf, 180 grit (1) Mini polishing pastes, white (P/N 40013) and blue (P/N 40014) Spacer ring set (1 P/N 40007) Flat flap disc, 80 grit (1 P/N 36080) FIX backing pad (1 P/N 80150JF) FIX Zirconium discs, 40, 60, 80 120 grit (1 ea.) FIX Pyramid discs, 400, 600, 1200 grit (1 ea.) FIX SuperPolish disc (1 P/N 80750N)
Replacement Discs	Flat flap disc, 60 grit (1 P/N 36060) Flat flap disc, 80 grit (1 P/N 36080) Flat flap disc, 120 grit (1 P/N 36120)

Flexible Shaft

for use with VARILEX®, Angle Grinders and MULTI-MAX



The new flexible drive shaft with a sturdy core and 5/8"-11 thread means that the MULTI-MAX can now be upgraded to a powerful professional drive motor. Ideal for narrow and awkward spots. Accepts 1/8" or 1/4" shaft abrasives and with an adapter for polishing rings up to 6" diameter. The Flexible Shaft features an ergonomic handgrip with vibration reduction.

5/8"-11 UNC connecting thread can also be used with the VARILEX® WSF 1800 or Angle Grinders!

See page 94-95 for details about the VARILEX® WSF 1800.



Flexible Shaft Ordering Information

Item	Part No.
Flexible shaft with 5/16" steel wire and 5/8" thread	10015
Separate 1/8" collet for flexible shaft	10011A
Separate 1/4" collet for flexible shaft	10011B
Machine holder (powder-coated steel) incl. clamping screw for VARILEX® WSF 1800	10008

VARILEX® WSF 1800 Professional

The most powerful speed-controlled angle surface finishing and blending tool in its class.

Variable speed from 2000 to 7600 RPM, 15 Amp (1710 W) power, disc change in seconds without tools. For disc diameters of 4", 4-1/2", 5", 6" and 7".



VARILEX® is designed to efficiently maximize the capabilities of flap, grinding and cutting discs and the Hook & Loop system.

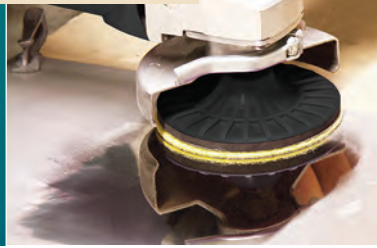

1 Simple, fast disc changing - with no tools - using the **5/8"-11 EASY-LOCK SPEED NUT**. P/N 65008-1



2 New ergonomic design with vibration-damping handle for comfortable, fatigue-free working.



3 Adjustable cover guard. P/N 65008-1



4 Dust-tight field coil with special coating.

Very powerful and infinitely adjustable



VARILEX® WSF 1800 Part No. 65000A

Safety Notice: Always use the protective wheel guard and follow all applicable safety instructions and regulations.



FLEXIBLE SHAFT - The new flexible drive shaft can now upgrade the VARILEX® WSF 1800 to a powerful professional drive motor for all applications. See page 93 for details.



5 Service cover allows the carbon brushes to be changed quickly.



6 Easy speed control during operation.



7 Ergonomically positioned locking ON/OFF switch.



8 QUICK-LOCK cable for fast, easy replacement if cable is damaged. 13 ft., included. P/N 52004-2

More than just an angle grinder – the most powerful single-handed multi-function machine available!

Change discs in seconds, without tools.



The VARILEX® has an infinitely adjustable speed between 2000 and 7600 RPM, for applications from grinding to blending, pre-polishing and polishing

- Ideal for use with both flap discs and polishing discs, as well as grinding and cutting wheels
- Balanced handle ensures fatigue-free grinding
- Tachogenerator keeps speed constant, even when grinder is operating at full load
- Variable-speed control doubles disc service life, prevents glazing of disc and workpiece heat deformation and reduces noise level
- Motor design allows exceptional performance at low RPM – without motor overheating or burnout
- EASY-LOCK clamping nut and spindle lock allows disc changeover in seconds

The VARILEX® is not designed for continuous use at low speed for polishing paint in the automotive trade.



VARILEX® WSF 1800 Specifications

Order No.	65000A	
Motor Power	15 Amp (1710 Watts); 110 Volt/60Hz (Also available: 230 Volt / 50 Hz)	
Speed Control Dial	Infinitely adjustable from 2000 to 7600 RPM	
Wheel Diameter	4" to 7"	
Spindle Thread	5/8"-11 UNC	
Arbor Size	7/8"	
Weight	6.2 lbs.	

Use with various discs and safety guards

Available with optional 7" safety guard for use with various-size grinding discs from 4" to 7" diameter (typical disc diameters are 4", 4-1/2", 5", 6" and 7").

Kit sets for VARILEX® WSF 1800 Professional Multifunction Tool



VARILEX® WSF 1800 Basic Starter Kit Part No. 80053

VARILEX® Basic Starter Kit includes 1 VARILEX® WSF 1800, 110 V with 5/8"-11 spindle, 1 Wheel guard for discs up to 5", 1 Carrying Case, 1 EASY-LOCK SPEED NUT, 2 PLANTEX® CERAMIC 5" grit 40, 2 PLANTEX® 5" grit 40, 2 PLANTEX® CERAMIC 5" grit 60, 2 PLANTEX® 5" grit 60.

FIX Hook & Loop System Kits

See page 105 for two versatile FIX Hook & Loop System kits.



5/8"-11 EASY-LOCK SPEED NUT Clamping System



Using the **EASY-LOCK SPEED NUT**, you can change the abrasive disc on the VARILEX® in a matter of seconds – without tools!

Easy hand tightening eliminates the need for wrenches and expensive 5/8"-11 hubs. **Part No. 65008-1**

➤ TIPS & TRICKS



Polish stainless steel to a mirror finish with the VARILEX® WSF 1800 Professional

(1) Initial grinding (remove scratches and roller scale, level welds) with TZ Pyramid disc A45 (grit 400) or A65 (grit 320). Finish with TZ Pyramid disc A30 (grit 600) and A16 (grit 1200). (→ page 106)

(2) Main polish with SuperPolish disc and white polishing compound, then with blue polishing compound. Important: Use a separate disc for each compound grit.

(3) Mirror finish with SuperPolish disc and pink polishing cream. (→ page 107)

FLAP DISCS

Longer, faster and
better grinding.

Unbeatable technology
and performance



Speed and endurance tests ensure superior results and progressive developments.

Speed test

Grinding discs are tested on a centrifugal test machine to ensure that they can withstand the sort of speeds that are required for grinding work. The test system can test discs at speeds of up to 30,000 RPM.

Endurance grinding test

Endurance tests are conducted to measure the material removal and service life of flap discs. New fabrics are tested to ensure their suitability and their grinding properties on various materials.

Strength and safety properties calculated using the finite element method (FEM).

PLANTEX® flap discs are approved for 260 ft./sec. to DIN EN 13743, approved by the MPA (Material Testing Institute) in Hanover and by the BGIA (Professional Association Institute for Industrial Safety). Compliant with ANSI B7.1.

Almost 50 years of experience and unbeatable technology go into the manufacture of every CS Unitec flap disc. In terms of material removal capacity, service life and grinding quality, PLANTEX® Flap Discs – made of hemp fiber high-tech compound – are among the best in the world.

Hard-Pressed Flaps

- Avoid chatter and vibration
- Maximize grit adhesion for extended grinding performance
- Consistent grinding/finishing results
- Stronger flap construction to minimize tearing

Hemp-Based Backing Plate

70% Natural Hemp Fiber, 30% Polypropylene

- Increased flexibility for improved performance
- Better absorbs vibration, noise and heat
- Environmentally friendly - remaining disc can be incinerated, leaving almost no residue
- No fiberglass, mineral fibers or epoxy resin

Complete Disc - Backing Plate and Flaps

- Patented adhesive system
- Adhesion process occurs throughout entire hardening process
- Results in a solid, compact, long-lasting abrasive

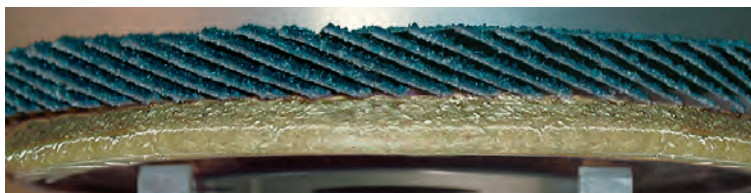

CS Unitec Flap Disc

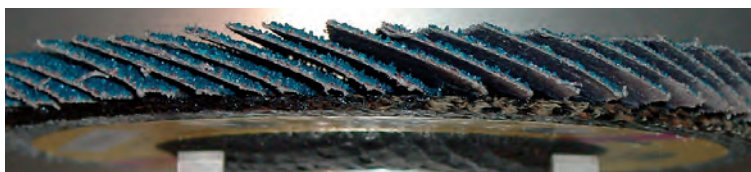

Standard Flap Disc

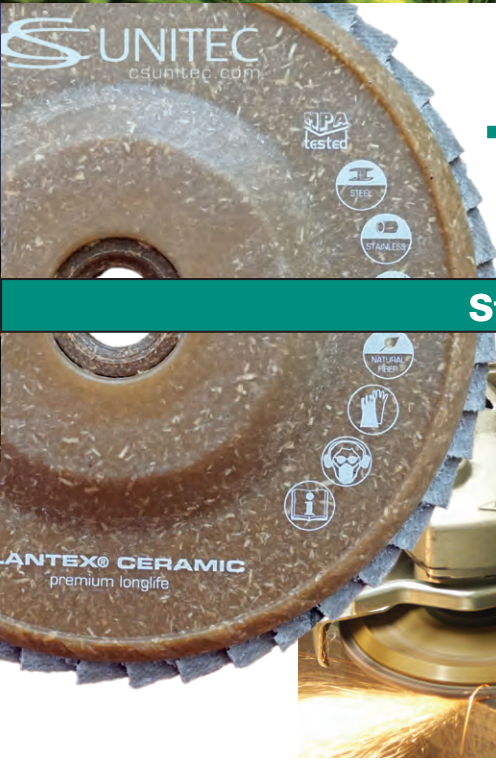

The **PLANTEX**® Advantage

Hightech-Compound

Steel/Stainless Steel/Aluminum

More Efficient Grinding

- Greater surface area contact resulting in higher metal removal rates
- Runs cooler with no smearing on workpiece

Safer Working Conditions

- No fiberglass, no mineral fibers, no epoxy resin
- No harsh fumes
- Reduced vibration and noise

Environmentally Friendly

- Majority of backing plate composed of hemp, a renewable resource
- Disposal of backing plate is safe and easy: Polypropylene combusts to approx. 1% carbon

Competitively Priced

- 100% service life - use to last fraction of an inch of abrasive flap
- Lower cost of production
- Efficient grinding requires fewer discs per project



The flexibility of the **PLANTEX**® backing plate better conforms to workpiece, providing greater surface contact, higher metal removal rates and cooler runs.

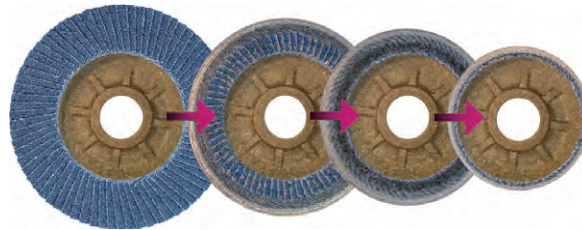
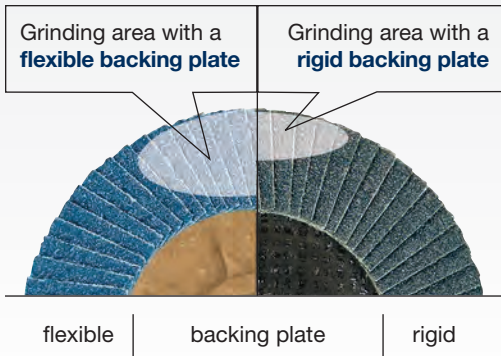

100% Service Life!

Use down to the last abrasive flap by automatic trimming during grinding or trimming using cutting tools on a sharp steel edge.

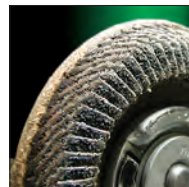

Trimming with cutting tools produces soft, harmless chips that can be disposed of as domestic waste (smell is similar to wood chips).

PATENTED!

Made in Germany







Grinding & Polishing Discs

CS Unitec flap discs are available in a wide range of grits and styles to meet your grinding, sanding, deburring, blending, cleaning and finishing needs.



Grinding/Weld Blending							
Grinding/Deburring							
Blending							
		Blending/Cleaning/Finishing					
						Fine Finishing	
40 Grit	50 Grit	60 Grit	70 Grit	80 Grit	90 Grit	100 Grit	120 Grit
PLANTEX® SUNFIRE™: All Metals							
PLANTEX® Universal: Steel, Stainless and Non-Ferrous Metals							
PLANTEX® CERAMIC: All Metals							
PLANTEX® COOL TOP®: Stainless							
PLANTEX® TIGER SHARK®: Aluminum							

Flap Disc	Page No.	Flap Material	Available Dia.	Arbor	Grits	Max. Speed 4-1/2" disc
Ideal for all metals – stainless steel, steel, aluminum, titanium, bronze and special alloys:						
 PLANTEX® SUNFIRE™	100	Ceramic	4-1/2", 5"	5/8" x 11 threaded	Multigrain 40/60	13,200
Ideal for steel, stainless steel and nonferrous metals:						
 PLANTEX® Universal	102	Zirconium	4", 4-1/2" 5", 7"	5/8" x 11 threaded; 5/8" or 7/8"	40, 60, 80, 120	13,200
Ideal for all metals – stainless steel, steel, aluminum, titanium, bronze and special alloys:						
 PLANTEX® CERAMIC	103	Zirconium blend	4", 4-1/2" 5", 7"	5/8" or 7/8"	40, 60	13,200
Ideal for steel and stainless steel:						
 PLANTEX® COOL TOP®	102	Zirconium blend	4", 4-1/2" 5", 7"	5/8" or 7/8"	40, 60	13,200
Ideal for aluminum:						
 PLANTEX® TIGER SHARK®	104	Ceramic/Corundum, with grinding aid	4", 4-1/2" 5", 7"	5/8" or 7/8"	40, 60, 80, 120	15,000

Grinding & Polishing Pads & Discs

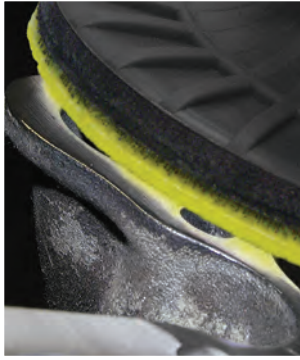

FIX HOOK & LOOP SYSTEM

Highly flexible backing disc with strong Hook & Loop fastening for outstanding finish quality. **See page 105-107**



FIX Zirconium Disc

Abrasive disc with Hook & Loop fastening and an outstanding grinding capacity. Ideal for body shops and car workshops.

Diameter: 4-1/2" and 6"
Grits: 40, 60, 80, 120

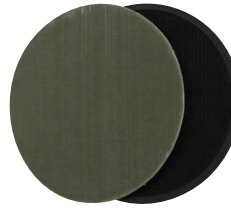

FIX TZ Pyramid Disc

Abrasive fabric with pyramid-shaped grit structure for high material removal while producing a very fine finish. Ideal for pre-polishing for mirror finishes and for removing scratches and spot welds.

Diameter: 4-1/2" and 6"
Grits: A65, A45, A30, A16, A06



FIX Fleece (Nonwoven) Disc

Versatile disc for fine surface conditioning and pre-polishing.

Diameter: 4-1/2" and 6"
Grits: coarse, medium, fine, superfine



FIX-Klett (Nonwoven) Disc

The FIX-Klett disc is a superfine soft nylon-fleece material for pre-polishing aluminum or other soft, nonferrous materials to a mirror finish.

Diameter: 4-1/2" and 6"
Grit: Superfine



FIX SuperPolish Disc

SuperPolish is a special needle fleece that produces a perfect, brilliant mirror finish on stainless steel and nonferrous metals.

Diameter: 4-1/2" and 6"
Thickness: 1/4"

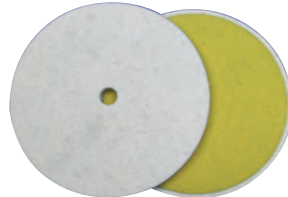

FIX SuperPolish Felt Disc

Special merino wool felt that produces a perfect, brilliant mirror finish on stainless steel and nonferrous metals.

Diameter: 4-1/2" and 6"
Thickness: 1/4"

GRINDING & FINISHING DISCS

Options for grinding and polishing, stainless steel and more. **See page 108-109**



POLY-MAGIC-WHEEL

Highly compressed fleece discs, ideal for grinding and dry polishing in corners (and on bead and corner welds).

Diameter: 6-1/2"
Grits: 80, 900



MAGNUM® TOPMIX

Increased material removal for removing spot welds and deep scratches on stainless steel, steel and nonferrous metals.

Diameter: 5"
Grit: 80

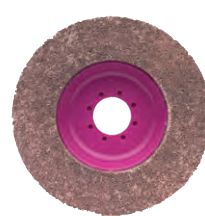

MAGNUM® FLEECE TOP

Versatile disc for surface conditioning, fine finishing and polishing – special material blend resists glazing and loading.

Diameter: 5"
Grits: 80, 180, 280, 400, 600, 900



MAGNUM® CLEAN

Designed for pore-deep cleaning of metals – cleans without harming the base material. Ideal for body shops and car workshops.

Diameter: 5"
Grit: Medium

Finishing & Maintenance Products



Pre-grinding and polishing compound, polishing cream, cleaning powder, microfiber cloths, hard sealant, mirror finish cleaner and polish protectant.



Use 100% of Disc

**PATENTED
multi-grain
grit structure**

PLANTEX® SUNFIRE™ CERAMIC GRIND, BLEND + FINISH... WITH ONE DISC!

- Remove up to 9 lbs. of metal with 1 disc
- Grind like a 40, blend and finish like a 60
- Patented multi-grain grit structure
- Ideal for steel, stainless steel, titanium, aluminum, bronze and more
- 5/8" x 11 hub



PLANTEX® - The Natural Advantage

Building on the strength of natural hemp fiber and its long history of use in industry, CS Unitec's PLANTEX® flap discs are a strong, reliable, chemical-resistant alternative to conventional fiberglass-backed discs. The hemp-based natural fiber backing plate is environmentally friendly and does not emit harsh fumes or glass splinters when in use. Industrial hemp, a natural renewable resource, is one of the strongest and most durable of all naturally grown fibers.



PLANTEX® SUNFIRE™ CERAMIC

40/60 Multi-Grain Grit – Ideal for all metals



Trimnable and elastic hemp fiber high-tech compound backing plate

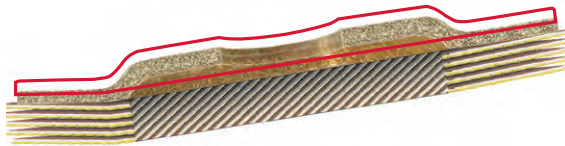

Easy Spin-On!
5/8"x11 Threaded Hub

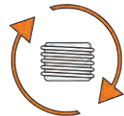

FLAPS:

- 40/60 combination multi-grain grit grinds like a 40, blends and finishes like a 60
- Innovative ceramic-hybrid grit structure provides aggressive material removal as well as controlled blending and finishing

BACKING PLATE:

- Composed of a high-tech, fiberglass-free compound
- Fiber backing is 70% natural hemp, a renewable resource
- High-strength construction, yet flexible to conform to the surface of the workpiece
- Extremely versatile – easily trimmable for a wide variety of applications and use in tight spaces
- Runs safer – no harsh fumes, airborne fibers or sharp pieces

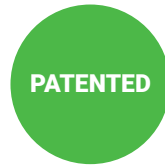
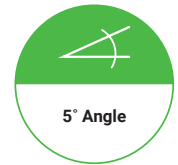
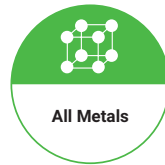

PLANTEX®
TRIMMABLE HEMP
BACKING PLATE



PLANTEX® SUNFIRE™ Ceramic Specifications

Dimensions	4 1/2" and 5" diameter	
Max. Speed	13,200 RPM for 4 1/2" diameter	
Ideal Speed	6000 to 9000 RPM	
Complies with	ANSI B7.1, 260 ft./sec. DIN EN 13743	
Grits	Multigrain 40/60	
Arbor Size	5/8" x 11	

PLANTEX® SUNFIRE Ordering Information

Part No. (Pack of 10)	Diameter	Grit	Ideal Speed (RPM)	Max. Speed (RPM)	Backing Plate
93520	4-1/2"	Multigrain 40/60	6,000 to 9,000	13,200	PLANTEX® 70% natural hemp fiber, 30% polypropylene
93521	5"			12,200	

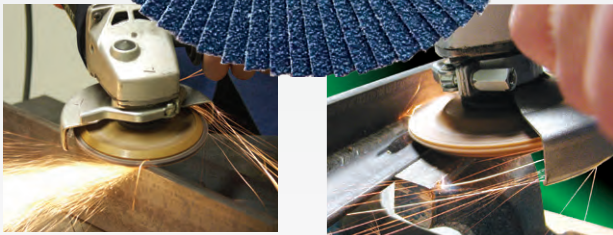

PLANTEX® UNIVERSAL Specifications

Dimensions	4 1/2" and 5" diameter
Max. Speed	13,200 RPM for 4 1/2" diameter
Ideal Speed	5000 to 8000 RPM
Complies with	ANSI B7.1, 260 ft./sec. DIN EN 13743
Grits	40, 60, 80, 120
Arbor Size	5/8"x11 threaded; 5/8" or 7/8"



PLANTEX® COOL TOP Specifications

Dimensions	4, 4 1/2", 5" and 7" diameter
Max. Speed	13,200 RPM for 4 1/2" diameter
Ideal Speed	5000 to 8000 RPM
Complies with	ANSI B7.1, 260 ft./sec. DIN EN 13743
Grits	40, 60 <i>(for finer grits, use PLANTEX UNIVERSAL 80 & 120)</i>
Arbor Size	5/8" or 7/8"

PLANTEX® UNIVERSAL

Flexible flap disc for general use.

The PLANTEX® high-tech compound is the standard flap disc for many companies. The flexible hemp-fiber backing plate is easily trimmed. High grinding performance is achieved with the 100% RZ-Zirconium abrasive fabric.

Easy Spin-On!
5/8"x11 Threaded Hub

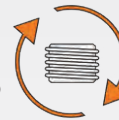

PLANTEX® UNIVERSAL Threaded Hub Ordering Info

Part No. (Pack of 10)	Diameter	Arbor	Grit	Ideal Speed (RPM)	Max. Speed (RPM)	Backing Plate
93564	4 1/2"	5/8" x 11 thread	40	5,000 to 8,000	13,200	PLANTEX® 70% natural hemp fiber, 30% poly- propylene
93566			60			
93568			80			
93569	120					
93574	5"		40	6,000 to 8,000	12,200	
93576			60			
93578		80				
93579			120			

PLANTEX® UNIVERSAL Ordering Information*

Part No. (Pack of 10)	Diameter	Arbor	Grit	Ideal Speed (RPM)	Max. Speed (RPM)	Backing Plate
93514	4"	5/8"	40	5,000 to 8,000	15,000	PLANTEX® 70% natural hemp fiber, 30% poly- propylene
93516			60			
93518			80			
93519			120			
93524	4 1/2"	7/8"	40	5,000 to 8,000	13,200	
93526			60			
93528			80			
93529			120			
93534	5"		40	6,000 to 8,000	12,200	
93536			60			
93538			80			
93539			120			

* 7" dia. with 7/8" arbor also available in 40, 60, 80 and 120 grits

PLANTEX® COOL TOP®

Cool performance for grinding stainless.

The PLANTEX® COOL TOP® high-tech compound has been specifically developed for grinding stainless steel.

Abrasive fabric with additional top coating improves grinding performance and service life and provides additional cooling.

PLANTEX® COOL TOP® Ordering Information

Part No. (Pack of 10)	Diameter	Arbor	Grit	Max. Speed (RPM)	Backing Plate
93614	4"	5/8"	40	13,200	PLANTEX® 70% natural hemp fiber, 30% poly- propylene
93616	4"	5/8"	60	13,200	
93634	5"	7/8"	40	12,200	
93636	5"	7/8"	60	12,200	
93644	7"	7/8"	40	12,200	

PLANTEX® CERAMIC

Ceramic high-performance flap disc with exceptional grinding performance for universal use on stainless steel and hard-to-grind metals. Save labor and time – one flap disc for all metals.

- Advanced high-performance ceramic grain improves production with maximum material removal and reduced grinding temperature
- Fiberglass-free hemp fiber backing plate offers increased disc flexibility and reduced vibration



The PLANTEX® CERAMIC high-tech compound has been specifically developed for grinding all metals including stainless steel, steel, aluminum, titanium, bronze and special alloys. Self-trimming backing pad allows for 100% use of abrasive.

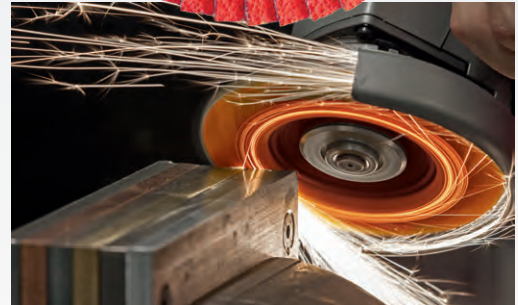

PLANTEX® CERAMIC Ordering Information

Part No. (Pack of 10)	Diameter	Arbor	Grit	Max. Speed (RPM)	Backing Plate
93552	4 1/2"	7/8"	80	13,200	PLANTEX® 70% natural hemp fiber, 30% poly- propylene
93555	5"		40	12,200	
93556			60		
93557			80		

PLANTEX® CERAMIC Specifications

Dimensions	4 1/2" and 5" diameter
Max. Speed	13,200 RPM for 4 1/2" diameter
Ideal Speed	5000 to 8000 RPM
Complies with	ANSI B7.1, 260 ft./sec. DIN EN 13743
Grits	40, 60, 80
Arbor Size	7/8"

↓ TIPS & TRICKS

EASY-LOCK SPEED NUT SAVES TIME, WEIGHT AND MONEY!

Never has changing a grinding disc been so quick and efficient

The secret behind it – the self-clamping **EASY-LOCK SPEED NUT**

Part No. 65008-1 (5/8"-11 UNC)

The **EASY-LOCK SPEED NUT** allows abrasive discs to be changed in seconds without tools. The **SPEED NUT** works with any abrasive with a hemp or ABS backing plate and a 7/8" arbor. That means you can change abrasives on an angle grinder in a matter of seconds. It easily hand tightens and eliminates the need for wrenches or heavy, expensive 5/8"-11 hubs.

The clamping collar shape on the top of the **EASY-LOCK SPEED NUT** can secure flap discs and abrasives with a "thicker" backing disc as well as centering them. "Thin" abrasives such as cutting discs, etc. can simply be secured using the reverse of the **EASY-LOCK SPEED NUT** clamping nut.

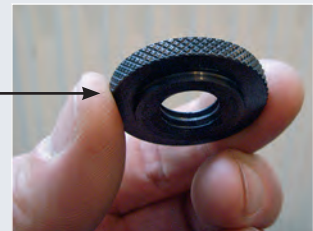

1. Secure the disc loosely by hand using the SPEED NUT.
2. Press the spindle lock and tighten the disc by turning it clockwise by hand. That's all there is to it!
3. To release the disc, press the spindle lock and turn the disc counter-clockwise by hand.



PLANTEX® TIGER SHARK® & KANGAROO ALU-FIX® OIL

The new dimension for grinding aluminum.

PLANTEX® TIGER SHARK® elastic discs are unbeatable for the difficult grinding of aluminum.

- High material removal, reduced grinding temperature and no glazing with aluminum particles
- Ceramic/corundum cotton abrasive fabric
- Ideal for curved surfaces and shapes; often used in car body shops, car workshops and for tool making
- Optional Kangaroo ALU-FIX® OIL minimizes loading and increases material removal rate by up to 300%, as well as improves finish quality (see below)



PLANTEX® TIGER SHARK® Specifications

Dimensions	4, 4 1/2", 5" and 7" diameter
Max. Speed	13,200 RPM for 4 1/2" diameter
Ideal Speed	5000 to 8000 RPM
Complies with	ANSI B7.1, 240 ft./sec. DIN EN 13743
Grits	40, 60, 80 120
Arbor Size	5/8" or 7/8"



Unique flap discs with a PLANTEX® flexible backing disc.

PLANTEX® TIGER SHARK® Ordering Information

Part No. (Pack of 10)	Diameter	Arbor	Grit	Max. Speed (RPM)	Backing Plate
93814	4"	5/8"	40	15,000	PLANTEX® 70% natural hemp fiber, 30% poly- propylene
93816			60		
93818			80		
93819			120		
93824	4 1/2"	7/8"	40	13,200	
93826			60		
93828			80		
93829			120		
93834	5"	7/8"	40	12,200	
93836			60		
93838			80		
93839			120		
93844	7"	7/8"	40	8600	
93846			60		
93848			80		
93849			120		

Kangaroo ALU-FIX® OIL

Spray on aluminum workpiece to improve the removal rate and increase abrasive life. Available in a 1-pint spray bottle or a 1.3 gallon canister with a spray bottle.

- 1-pint spray bottle – **Part No. 40010**
- 1.3 gal. canister and spray bottle – **Part No. 40010K**

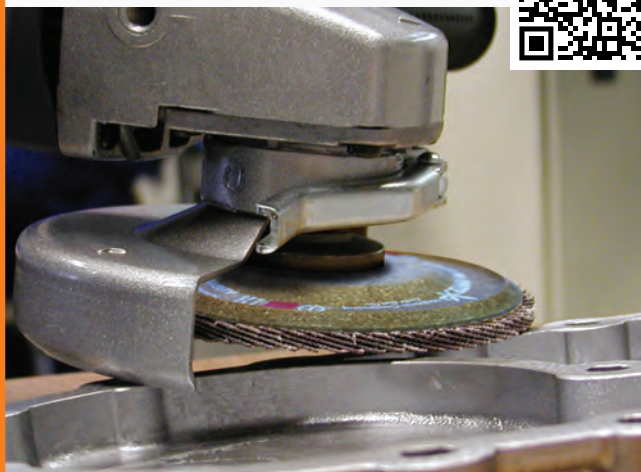
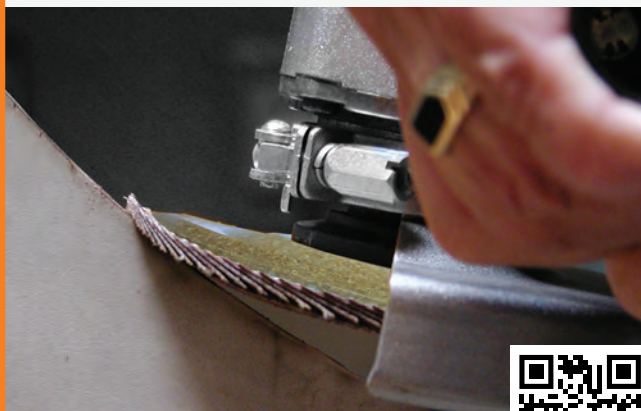

FIX HOOK & LOOP SYSTEM

PATENTED!

Highly flexible backing disc for high-quality finishes. Ideal for surface conditioning and polishing up to a mirror finish.

The FIX Hook & Loop system takes advantage of a flexible backing pad and allows a disc to be changed in seconds without tools.

The FIX Hook & Loop system is a good fit wherever disc flexibility and frequent changeover are required. It will save time in industrial metalworking applications such as car body shops and repair shops.

The system requires a speed-controlled angle grinder, such as the VARILEX® WSF 1800 Professional. A wide range of abrasives are available for all steps – from rough grinding up to a mirror finish.

The FIX Hook & Loop's "green" backing disc is made of natural materials. The flexibility of the abrasives allows you to achieve results similar to stationary grinding machines.

The FIX family of abrasives must be used with the FIX original backing disc.



The FIX Hook & Loop system is an essential surface finishing and polishing system for all sheet metal applications.

FIX Hook & Loop System Kits



FIX Test Kit

This kit contains all the FIX Hook & Loop System components to go from rough grinding up to a mirror finish. **Part No. 80051U**

- 1 Carrying case
- 1 FIX backing pad
- 8 FIX Zirconium discs 4-1/2"
(2 each - 40, 60, 80, 120 grit)
- 10 FIX TZ Pyramid discs 4-1/2"
(2 each - 320, 400, 600, 1200, 2000 grit)
- 8 FIX Surface Conditioning discs 4-1/2"
(2 each - coarse, medium, fine, superfine)
- 6 FIX SuperPolish discs 4-1/2"
- 2 Mini-polishing pastes, white and blue
- 1 PTX polishing cream pink
- 1 PTX Brightex® Softclean Powder scatter can
- 2 PTX microfiber cloths
- 1 Sample size PTX Poly Protection
- 1 Sample size PTX Brilliance Clean



FIX Starter Kit

This kit includes a range of FIX Hook & Loop components, as well as a VARILEX® WSF 1800 Angle Grinder. **Part No. 80050U**

- 1 VARILEX® WSF 1800, 110V, 5/8" spindle
- 1 Carrying case
- 1 FIX backing pad - 4-7/16"
- 1 Wheel guard for discs up to 5"
- 3 FIX fleece discs 4-1/2" (1 each - coarse, medium, fine)
- 1 EASY-LOCK SPEED NUT
- 2 FIX FLEECE TOP 4-1/2" (1 each - grit 80, 180)
- 2 FIX flap discs 4-1/2" (1 each - grit 40, 60)
- 2 FIX SuperPolish discs 4-1/2"
- 1 FIX clean 4-1/2"
- 1 PTX Brightex® Softclean Powder scatter can
- 4 FIX Zirconium discs 4-1/2" (1 each - grit 40 - 120)
- 2 Mini-polishing pastes, white and blue

Abrasives for the FIX Hook & Loop System

The FIX family of abrasives must be used with the FIX original backing disc.



Special FIX Backing Pad (without Foam) with Centering Pin

For use with the FIX Zirconium disc, FIX TZ Pyramid disc and FIX SuperPolish disc. The backing disc is made of special elastic material with a centering pin for perfect alignment.

Diameter: 4-1/2" with 5/8"-11 thread – **Part No. 80115U**
 Diameter: 6" with 5/8"-11 thread – **Part No. 80150U**



Special FIX Backing Disc with PUR Foam Absorption Coating and Centering Pin

For use with the FIX Zirconium disc, FIX TZ Pyramid disc and FIX Super-Polish disc. The backing disc is made of flexible PUR with a special 1/4" absorption coating with a centering pin for perfect alignment.

Diameter: 4-1/2" with 5/8"-11 thread – **Part No. 80115UF**
 Diameter: 6" with 5/8"-11 thread – **Part No. 80150UF**



FIX Zirconium Disc

Abrasive disc with Hook & Loop fastening and an outstanding grinding capacity. Ideal for body shops and car workshops.

Diameter: 4-1/2" and 6"
Grits: 40, 60, 80, 120

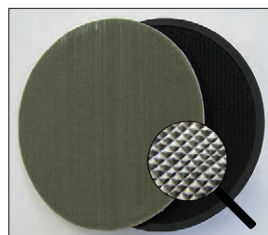

FIX TZ Pyramid Disc

Abrasive fabric with pyramid-shaped grit structure for high material removal while producing a very fine finish. FIX TZ Pyramid discs reduce the amount of work required compared to grinding belt sleeves and fleece sleeves. Ideal for pre-polishing for mirror finishes and for removing scratches and spot welds. An additional

absorption coating dramatically reduces the grinding temperature and protects the Hook & Loop components and the workpiece.

Diameter: 4-1/2" and 6"; Grits: A65, A45, A30, A16, A06
 (see grit equivalents on below)

FIX Zirconium Disc Ordering Information

Part No.	Diameter	Grit	Quantity
80904	4 1/2"	40	50 pack
80906		60	
80908		80	
80909		120	
80914	6"	40	50 pack
80916		60	
80918		80	
80919		120	

FIX Zirconium Disc Ordering Information

Part No.	Diameter	Grit	Quantity
80932	4 1/2"	A65/320	10 pack
80940		A45/400	
80960		A30/600	
80970		A16/1200	
80980		A06/2000	
80985	6"	A65/320	10 pack
80986		A45/400	
80987		A30/600	
80988		A15/1200	
80989		A06/2000	

Grit Equivalents

A100 = Grit 220
 A65 = Grit 320
 A45 = Grit 400
 A30 = Grit 600
 A16 = Grit 1200
 A06 = Grit 2000



FIX Fleece (Nonwoven) Disc

Versatile disc for fine surface conditioning and pre-polishing.

Diameter: 4-1/2" and 6"
Grits: coarse, medium, fine, superfine

FIX Fleece (Nonwoven) Disc Ordering Information

Part No.	Diameter	Grit	Quantity
80615	4 1/2"	coarse (brown)	10 pack
80616		medium (red)	
80617		fine (blue)	
80618		superfine (grey)	
80650	6"	coarse (brown)	10 pack
80651		medium (red)	
80652		fine (blue)	
80653		superfine (grey)	



FIX-Klett (Nonwoven) Disc

The new FIX-Klett disc is a superfine soft nylon-fleece material for pre-polishing aluminum or other soft, nonferrous materials to a mirror finish.

Diameter: 4-1/2"; Superfine grit, **Part No. 80680 (10 pack)**
 Diameter: 6"; Superfine grit, **Part No. 80690 (10 pack)**

SuperPolish Discs for the FIX Hook & Loop System



FIX SuperPolish Disc

SuperPolish is a special needle fleece that produces a perfect, brilliant mirror finish on stainless steel and nonferrous metals. Use with our polishing compounds (white and blue)

and pink cream to avoid smears and shadows. SuperPolish is absorbent, does not smear and saves time.

Diameter: 4-1/2"; Thickness: 1/4", Part No. 80715N (10 pack)

Diameter: 6"; Thickness: 1/4", Part No. 80750N (10 pack)

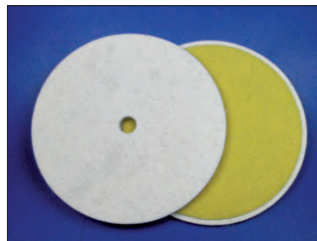

FIX SuperPolish Felt Disc

Special merino wool felt that produces a perfect, brilliant mirror finish on stainless steel and nonferrous metals. Use with our polishing compounds (white and blue) and pink cream to avoid smears and shadows.

Diameter: 4-1/2"; Thickness: 1/4", Part No. 80715 (10 pack)

Diameter: 6"; Thickness: 1/4", Part No. 80750 (10 pack)

When polishing with **FIX SuperPolish Discs**, use a separate SuperPolish disc for each compound and cream. The different compound grits must not be mixed. Remove compound and cream residues from the workpiece after each stage using PTX Brightex® Softclean Powder and a microfiber cloth.

Polishing and Maintenance Products



PTX Pre-grinding & Polishing Compound

Essential for polishing all metals, including stainless steel, aluminum, etc.

PTX WHITE pre-polishing compound (23 oz.) – Part No. 40013

PTX BLUE finishing compound (23 oz.) – Part No. 40014

PTX WHITE and BLUE mini pastes (approx 4.2 oz. ea.) – Part No. 40009



PTX Polishing Cream, Pink

For high reflective finishing. Produces a perfect mirror finish on stainless steel and nonferrous metals when used with the SuperPolish Sleeve or Belt.

Miniature tube, 2 oz. – Part No. 40015T

Can, 2.2 lbs. – Part No. 40015



PTX Brightex® Softclean Powder (non-caustic)

For removing cream and compound residues. Scatter on the surface and wipe off with a microfiber cloth.

Aluminum scatter container with Brightex® (approx. 7 oz.) – Part No. 40029

Can, 2.2 lbs. – Part No. 40028

Scatter container only – Part No. 40020



Microfiber Cloths

For pore-deep cleaning and even distribution of maintenance products and polishes. Our microfiber cloths produce a top finish on all materials.

Size: 13" x 14" – Part No. 40031



INOX-Protect (hard sealant)

Protects finished and polished metal surfaces (stainless steel, steel, aluminum, brass, copper, etc.) with a clear, dry adhesive film. Removes fingerprints and other dirt.

Canister (w/ spray bottle), 1.3 gal. – Part No. 40041

Spray bottle, 17 oz. – Part No. 40040



Brilliance-Clean

For streak- and residue-free cleaning of all surfaces, including stainless steel, steel, aluminum, brass and copper. Brilliance-Clean is not harmful to plastics, wood or coated surfaces. It removes fingerprints, dust, compound residue, minor oil and grease marks and adhesive residue

effortlessly. Evaporates quickly without leaving any residue on the surface.

Canister (w/ spray bottle), 1.3 gal. – Part No. 40051

Spray bottle, 17 oz. – Part No. 40050



POLY Protection (oil film)

For cleaning and preserving finished and polished stainless steel and nonferrous metal surfaces. Protects against shadows and finger and water marks for a long time. Spray on and rub off with a microfiber cloth. Produces a darker effect on finished surfaces.

Canister (w/ spray bottle), 1.3 gal. – Part No. 40012

Spray bottle, 17 oz. – Part No. 40011

TIPS & TRICKS

Perfect mirror finish on stainless steel and nonferrous metals

The new TZ Pyramid and SuperPolish discs for the FIX Hook & Loop system can be used with an angle grinder to create perfectly polished finishes on stainless steel and nonferrous metals.

Pre-grinding to remove scratches and level welds using TZ Pyramid discs with grit A30.

Fine grinding using TZ Pyramid discs with grit A16.

These two stages prepare the surface for polishing. TZ Pyramid is an aggressive abrasive, so there is no need to slowly increase the grit fineness. Use only contact pressure to grind – the weight of the grinder is generally sufficient.

Pre-polish with SuperPolish disc and white polishing compound.

Main polish with SuperPolish disc and blue polishing compound.

Perfect mirror finish with SuperPolish disc and pink cream.

Use a separate SuperPolish disc for each step – the different compound grits must not be mixed. Remove compound and cream residues after each stage using PTX Brightex® Softclean Powder and a microfiber cloth.

POLY-MAGIC-WHEEL

Dry polish stainless steel in corners up to a mirror finish!

The POLY-MAGIC-WHEEL is designed for finishing and dry polishing in corners, producing up to a perfect mirror finish in just two steps. These discs are composed of highly compressed fleece material, made by compressing single flaps that are then impregnated with foam for greater strength. This special process allows considerably more abrasive material to be used than on conventionally wound "unitized wheels and discs."

The POLY-MAGIC-WHEEL is ideal for grinding and polishing bead and corner welds. It may only be used frontally.

Ideal for speed-controlled angle grinders.



Polishing corner welds with the POLY-MAGIC-WHEEL

Obtaining good polish quality when finishing corner welds is difficult, especially for the fabrication of railings. The POLY-MAGIC-WHEEL was designed to help you more easily produce a truly perfect finish in these applications. This highly compacted fleece disc was designed specifically for grinding and polishing bead and corner welds.

Carry out the initial grinding and leveling of welds with the red disc, grit A (80 grit).

Then polish to a mirror finish using the POLY-MAGIC gray disc, grit B (900 grit). These discs are very aggressive and improve productivity. No polishing compounds or creams are required for polishing with the POLY-MAGIC-WHEEL (dry polish).

POLY-MAGIC-WHEEL

Dimensions	6 1/2" dia. x 7/8" arbor
Max. Speed	5000 RPM
Ideal Speed	3000 to 4000 RPM
Grits	A/80 (red): for initial grinding and leveling welds (P/N 96720, 5 pk.)
	B/900 (gray): for polishing to a perfect mirror finish (P/N 96721, 5 pk.)

Mirror finish in 2 steps:



1 POLY-MAGIC-WHEEL A (80 grit)



2 POLY-MAGIC-WHEEL B (900 grit)



MAGNUM® TOPMIX

Increased material removal, longer service life.

The MAGNUM® TOPMIX was developed to increase material removal during finishing while also improving service life. The 80 combination grit is much more aggressive than our MAGNUM® FLEECE TOP 80 grit (see next page). Individual flaps with foamed and compressed fleece offer a much higher removal capacity, making it ideal for removing spot welds and deep scratches on stainless steel, steel and nonferrous metals. The coordinated fleece combination additionally ensures that a good finish is achieved. The MAGNUM® TOPMIX also offers excellent service life, making deburring and cleaning of cast parts and welds a breeze.

Ideal for speed-controlled angle grinders.

MAGNUM® TOPMIX

Dimensions	5 dia. x 7/8" arbor
Max. Speed	6000 RPM
Ideal Speed	2000 to 4500 RPM
Grits	40/80 (P/N 96705, 5 pk.)



MAGNUM® FLEECE TOP

Made of foamed, compressed grit, interspersed nonwoven fleece.

The MAGNUM® FLEECE TOP is a versatile fleece disc for surface conditioning, fine finishing and polishing, offering up to 8x the service life of traditional fleece and surface conditioning discs. The FLEECE TOP is an ideal disc for metalworking that requires fine grinding and pre-polishing to a uniform clean finish. It is effective at descaling and removing oxidation, scratches, rust, burrs and paint. It replaces a wire brush, abrasive paper and grinding rubbers and is self cleaning, with a special mixture that prevents glazing and loading. The foamed fleece ring is approx. 5/8" thick. This highly compressed quantity of fleece material ensures an extra-long service life.

Ideal for speed-controlled angle grinders.

MAGNUM® FLEECE TOP

Dimensions 4 1/2" dia. x 7/8" arbor

Max. Speed 8000 RPM

Ideal Speed 2000 to 4500 RPM

Grits
80 (P/N 96710, 5 pk.)
180 (P/N 96711, 5 pk.)
280 (P/N 96712, 5 pk.)
400 (P/N 96713, 5 pk.)
600 (P/N 96714, 5 pk.)
900 (P/N 96715, 5 pk.)

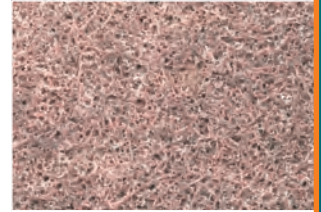
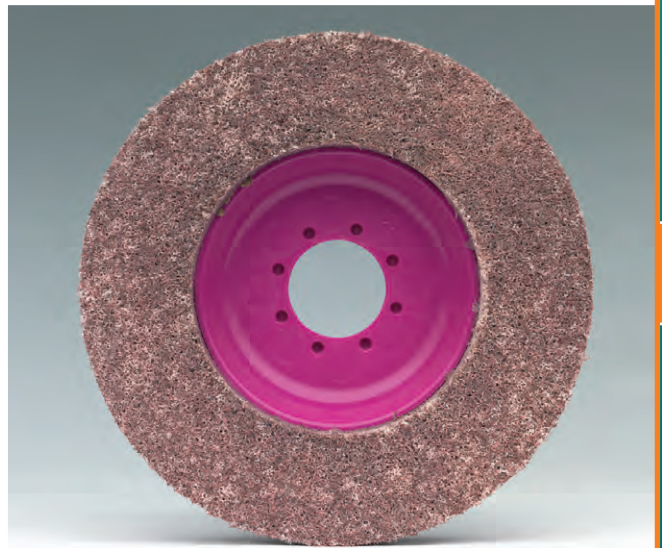

MAGNUM® CLEAN

For pore-deep cleaning of metals (sandblasting effect).

MAGNUM CLEAN® is a flexible cleaning disc for the pore-deep cleaning of metals. This flexible coarse fleece disc is interspersed with silicon carbide grit and cleans without harming the base material. The disc itself is iron free, which means that there is no risk of corrosion. The coarse fleece material will not glaze or load, even if exposed to heavy contamination. MAGNUM CLEAN® is the ideal cleaning disc for pore-deep removal of paint, rust, scale and oil smears, as well as for cleaning and exposing without material removal. It is ideal for use in body shops (cleans thin sheet metal with no material removal) and in the automotive industry, and it is also suitable for undersealing, renovating, painting and building work. MAGNUM CLEAN® is particularly good for removing paint and other coatings on wood, stone and metal (including window frames, doors and frames, furniture, house facades, graffiti, railings, fences, supports and machines).

Ideal for speed-controlled angle grinders.

MAGNUM® CLEAN

Dimensions 5 dia. x 7/8" arbor

Max. Speed 5000 RPM

Ideal Speed 2000 to 4500 RPM

Grits **Medium** (P/N 96700, 5 pk.)

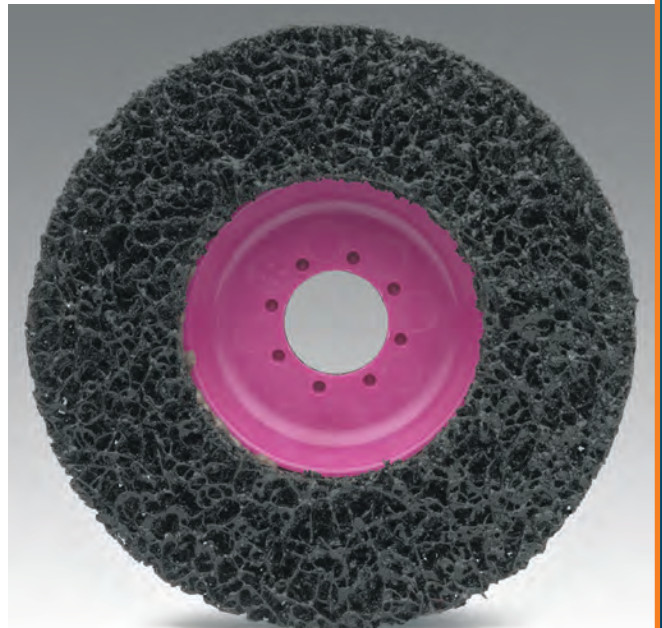

PIPE-MAX

Pipe Belt Grinder

Combination pipe belt sander and grinder for diameters up to 14"

Follow contours to grind and polish pipes and handrails up to a high-gloss finish

- Grinds weld seams on flat surfaces – leaves no edges
- Belt wraps around pipe and requires only a few steps to polish entire circumference
- Powerful 15 Amp motor and variable-speed control from 950 to 3500 RPM
- Quick and easy changing of sanding belts
- Ideal for stainless steel, aluminum and high-quality metals

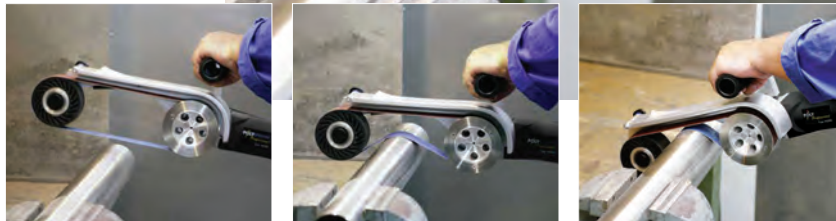

You can follow the external contour of the pipe diameter with light, uniform contact pressure. The new contour concept with the elastic return roller allows the grinding and polishing belts to conform around the external diameter of the pipes without great force.



1 Gas pressure cylinder allows belt to conform to contour of pipe with proper pressure.



2 Additional handle for comfortable, overhead working.



3 The drive roller with the rubber rings ensures that the grinding belts will not slip.



The soft grinding roller made of PUR material also allows comfortable longitudinal grinding of flat surfaces, for example to remove spot welds or eliminate deep scratches.

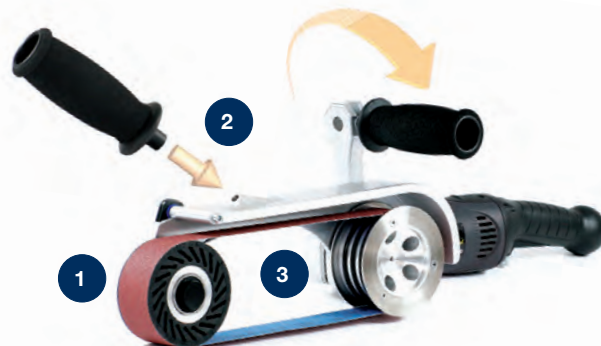

PIPE-MAX Specifications

Order No.	38502A
Belt Size	30.7" L x 1.5" W*
Power	15 Amp (1710 W) / 110V
Pipe ø Max.	14"
Weight	11.25 lbs.

Standard Equipment

1 PIPE-MAX basic machine, 110V	2 PIPE-MAX SC-fleece belts, medium
1 QUICK-LOCK cable, 13 feet	2 PIPE-MAX SC-fleece belts, fine
1 additional handgrip	3 spare rubber rings
PIPEMAX grinding belts, 2 each grits 40, 60, 80 and 120	

* Exact belt size is 780mm x 40mm 220 Volt also available

PIPE-MAX Accessories

PIPE-MAX Belts: Belt Size – 30.7" x 1.5" (780mm x 40mm)

10 belts per package

4 belts per package

Abrasive Grinding Belts		Abrasive Grinding Belts – Ceramic		TZ Pyramid Belts		Abrasive Surface Conditioning Fleece Belts		SuperPolish Belt
Grit	Part No.	Grit	Part No.	Grit	Part No.	Grit	Part No.	Part No.
24	38523	24	38124	A100/220	38544	Coarse (brown)	38531	38850
40	38524	36	38136	A65/320	38545	Medium (red)	38532	
50	38525	40	38520	A45/400	38546	Fine (blue)	38533	
60	38526	60	38160	A30/600	38547	Superfine (grey)	38534	
80	38528	80	38180	A16/1200	38548			
120	38529	100	38100					

Gladius® 1800 Multifunctional Grinder

Ideal for hard-to-reach areas such as corners, angles and tight spaces.

- Grind, deburr, blend and polish ferrous and nonferrous metals, wood and plastic
- Long, sword-shaped, belt-driven tool for finishing hard to reach areas
- Infinitely adjustable speed control from 1000 to 3800 RPM
- Tachogenerator provides constant speed, even under load
- Innovative design allows use of the full length of both sides of the arm for smooth grinding, blending and polishing
- Integrated dust extraction port reduces airborne particles when connected to an industrial vacuum



Gladius® 1800 Pro Kit Specifications

Order No.	38652A
Belt Size	30.7" L x 1.5" W*
Power	15 Amp / 110V
Speed	1000 - 3800 RPM
Weight	10 lbs.

* Exact belt size is 780mm x 40mm



The Gladius® 1800 uses the same abrasive belts as the PIPE-MAX. See page 110 for more information.

Gladius® 1800 Professional Kit

Part No. 38652A



Professional Kit includes:

- 1 Gladius® basic machine (110V)
- 1 QUICK-LOCK power cord (P/N 52004-2)
- 1 Machine stand (P/N 38660)
- 2 SC-fleece belts, medium grit (P/N 38532)
- 2 SC-fleece belts, fine grit (P/N 38533)
- 2 40 grit Zirconium abrasive grinding belt (P/N 38524)
- 2 60 grit Zirconium abrasive grinding belt (P/N 38526)
- 2 80 grit Zirconium abrasive grinding belt (P/N 38528)
- 2 120 grit Zirconium abrasive grinding belt (P/N 38529)
- 1 Aluminum carrying case (P/N 50102)

Convert the Gladius® 1800 to a bench-mounted grinder with optional machine stand for precision grinding and polishing.
Optional machine stand: Part No. 38660



ROLEI® BE 5 Sheet Metal Deburring Machine – 2 Speeds

Double-sided deburring of sheet metal up to 0.2" thick can be achieved in a single operation with no additional treatment. The machine's flap wheels can be easily adjusted as they wear. One set of wheels lasts for approximately 6500 feet of stainless steel sheet. Supplied standard with two 80 grit flap wheels, the ROLEI® BE 5 can be used with other optional grits to suit the facet width and materials of your particular application.



Features two-speed operation:

- Speed 1: fine deburring, 600 RPM
- Speed 2: standard deburring, 1200 RPM

Optional accessories:

- Spare flap wheels (40, 60, 80, and 120 grit)
- Machine stand, made from strong steel
- Port for industrial dust extractor (Part No. 30330)

ROLEI® BE 5 Specifications

Order No.	30310A (220 Volt) 30310 (380 Volt)
Motor	220V 3-phase, 2 speeds, .2 KW, 0.9 Amp 380V 3-phase, 2 speeds, .2 KW, 0.45 Amp
Dimensions	19.7" x 12.8" x 7.9"
Weight	64 lbs
Options	Machine stand, dust extractor connection port, teflon tape

ROLEI® BE 5 Flap Wheels

Part No.	Grit	Qty.
37040	40	2 discs per pack
37060	60	2 discs per pack
37080	80	2 discs per pack
37120	120	2 discs per pack

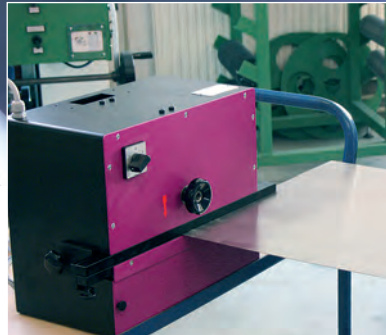
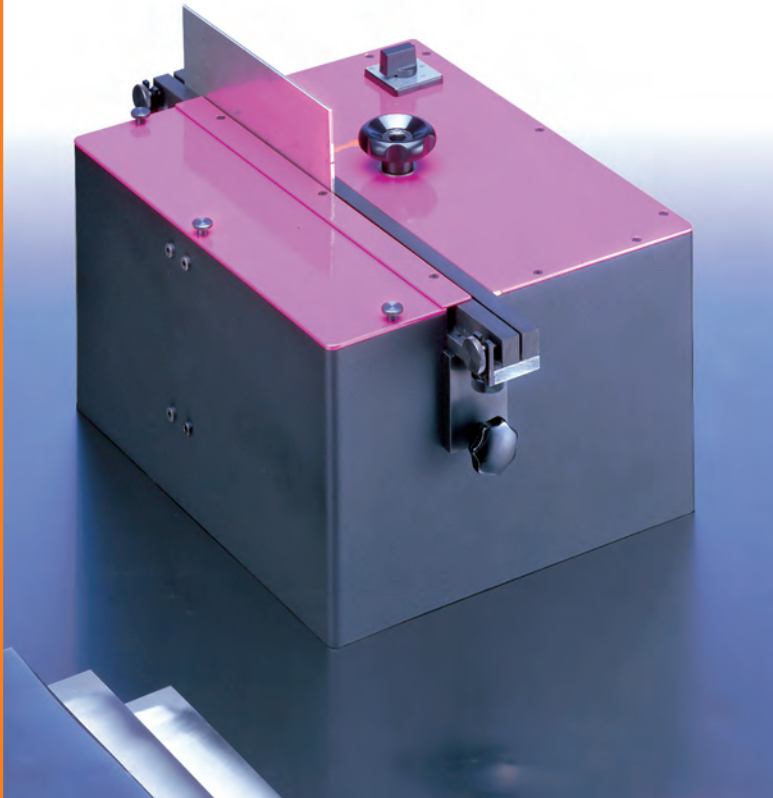

Can also be used on its side with roller tables for large thin sheets.

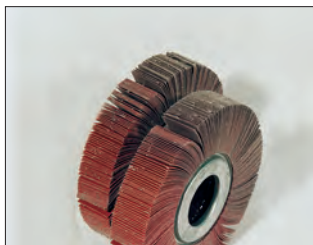
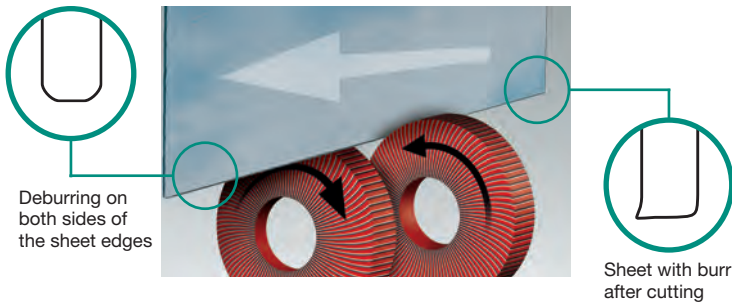

Spare flap wheels for sheet metal deburring machine BE 5
Grit 40, 60, 80, 120



Machine stand - Part No. 30320
Strong steel machine stand with black powder coating



Dust extraction port (end and bottom views shown above)
Part No. 30330



Teflon protective tape – self-adhesive (2 required)
Part No. 30341 (27.5" L x 3/4" W)
For extension rail to protect from scratching the workpiece

ROLEI® EF 115 Hand-held Deburring and Faceting Machine

This handy deburring machine is designed for awkward, heavy parts, such as machine tables, frame constructions or large sheets of metal. Easy to handle, with good edge control. The EF 115 is also ideal for chamfering welds. Fixed beveling angle of 45°, infinitely adjustable facet width from 0" to 3/8".



ROLEI® EF 115
110 V / 60 Hz
Variable speed: 2,000 to 7,600 RPM

ROLEI® EF 115 Specifications

Order No.	30116
Universal Motor	15 Amp (1710 W) 110/60 Hz (230V / 50 Hz, 1600 W also available)
Speed	Infinitely adjustable from 2000 to 7600 RPM
Weight	9 lbs
Options	Sliding Guide rail, plastic (Part no. 30117, 2-piece set)

The handy ROLEI® EF 115 can deburr and facet large, heavy parts with ease. The precise edge control guarantees clean bevels at an angle of 45°.



QUICK-LOCK cable for fast, easy replacement, e.g. if the cable is damaged. 13 ft., included. Part No. 52004-2



Simple disc changing.

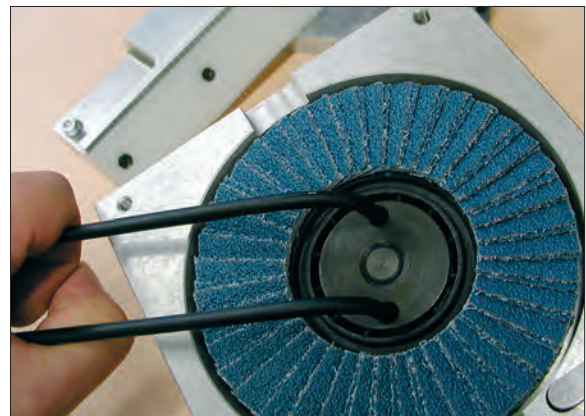

ROLEI® EF 115 Flap Discs

Part No.	Grit	Quantity
21050A	50	10 discs per pack
21060A	60	10 discs per pack
21080A	80	10 discs per pack
21120A	120	10 discs per pack

ROLEI® EF 165

Beveling and deburring machine for facets at an angle of 45°.

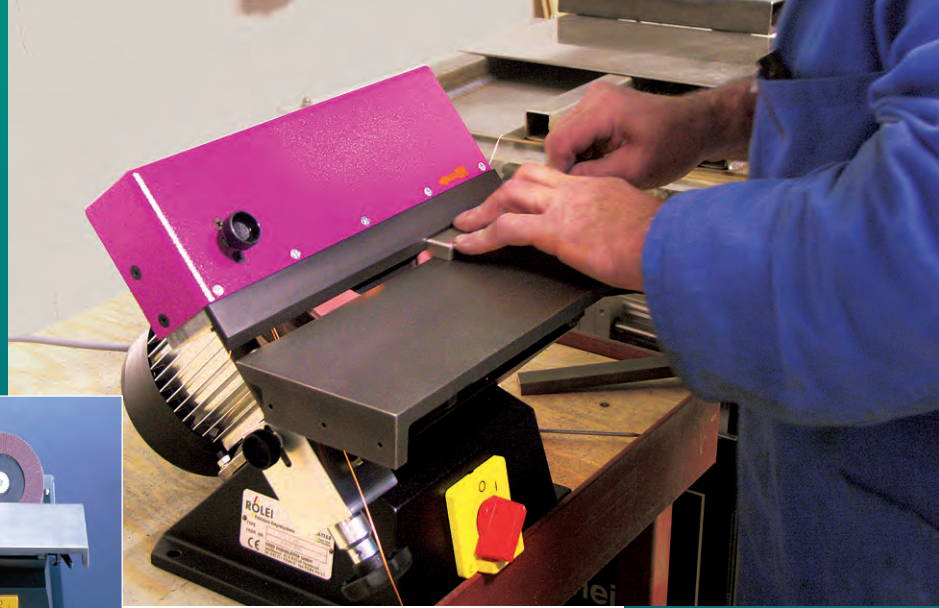

Optional dust extraction port
Part No. 30130

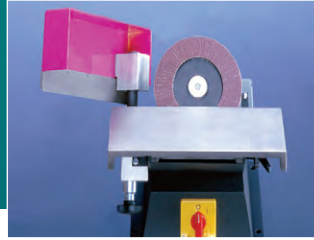

Beveling and deburring machine with a fixed beveling angle of 45° and an infinitely adjustable beveling width from 0" to 3/8" for all metals from stainless steel to aluminum. Precise adjustment of the face width using a hand wheel.

Optional accessories:

- Table extension (2 pieces, 5" x 13" each)
- Machine stand
- Extraction port for industrial dust extractor
- Spare flap discs (60, 80, 120 grit)



Machine stand
Part No. 30120
Sturdy steel machine stand with black powder coating.



Extended support table
Part No. 30110
Made of sliding grey cast material. 27-1/2" long



Spare flap discs
The flat disc with special hard compression for deburring machines. Self-sharpening and extremely long service life!

- 60 Grit Part No. 36060
80 Grit Part No. 36080
120 Grit Part No. 36120

ROLEI® EF 165
Speed: 2800 RPM



ROLEI® EF 165 Specifications

Order No.	30101 (220 Volt) 30100 (380 Volt)
Motor	220V single-phase or 380V 3-phase
Dimensions	14" x 13" x 12"
Support Table	5" x 13"
Weight	40 lbs.
Options	Table extension, machine stand, extraction port for dust extractor connection



Supplied as standard with 80 grit disc. Other grits can also be used to suit the facet width and materials.

ROLEI® PEF 500

Beveling and deburring machine for facets at angles of 30° to 60°.

Precision beveling and faceting machine for all metals from stainless steel to aluminum. Infinitely adjustable beveling angle from 30° to 60° and infinitely adjustable face width from 0" to 3/8" (precise adjustment using knob).

Optional accessories:

- Extraction port for dust (Part No. 30230)
- Sliding feed plate, plastic (Part No. 30210)
- Replacement flap discs (see below right)

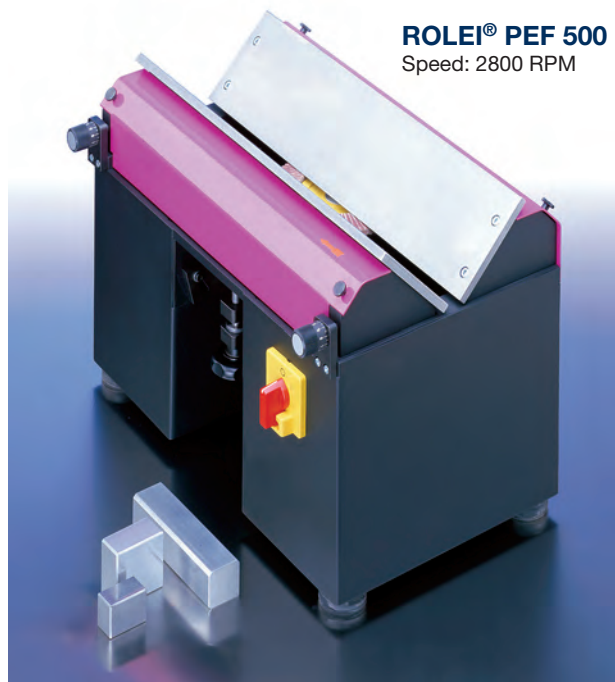

ROLEI® PEF 500
Speed: 2800 RPM

ROLEI® PEF 500 Specifications

Order No.	30201 (220 Volt) 30200 (380 Volt)	
Motor	220V single-phase or 380V 3-phase	
Dimensions	20" x 14" x 14"	
Weight	88 lbs.	
Options	Machine stand, extraction port for dust extractor connection	

Supplied as standard with 80 grit disc. Other grits can also be used to suit the facet width and materials.

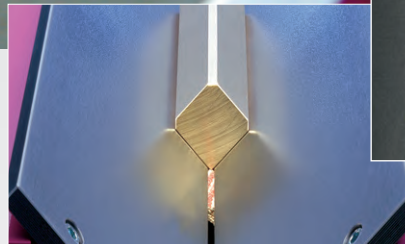

Parts are beveled with perfect cross-grinding – absolutely no opposite burr.



The face width can be adjusted precisely using a hand wheel.



The disc wear is adjusted using a hand wheel with a threaded spindle. The face angle can be adjusted using a motorized system.

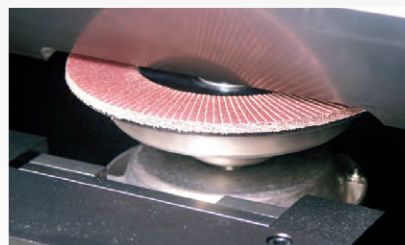

The easily interchangeable flat flap disc produces a chamfer which creates zero opposite burr.

- Replacement flap discs**
 60 Grit [Part No. 36060](#)
 80 Grit [Part No. 36080](#)
 120 Grit [Part No. 36120](#)



Infinitely adjustable facet angle from 30° to 60°

Multipurpose Beveling Machines

Bevel, deburr and chamfer edges of steel plate faster and cleaner than angle grinders.

- Bevel 30°, 45°, 2.5mm or 1.6mm radius on steel, stainless, nonferrous metals, brass and plastics
- Deburr and chamfer; straighten edges, internal and external radii; and countersink holes from 7/8" dia.
- Fine adjustment feature for slight chamfers when deburring for the preparation of weld seams
- Ideal for: **Boiler and process plant construction** (prepare weld seams on heat exchangers); **Mechanical engineering** (deburr machine parts, chamfer edges to protect against paint peeling and create visible edges); **Sheet metal** (deburr cut edges); **Moldmaking** (straighten edges, internal and external radii and countersink holes from 7/8" dia.)



Three Milling Options

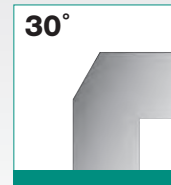

Milling cutter 30°, Chamfer 0 - 1/4"

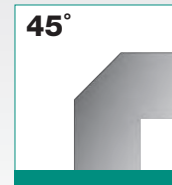

Milling cutter 45°, Chamfer 0 - 1/4"

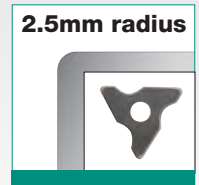

Milling cutter 2.5mm radius (0.098")



0-1/4" beveling width

Three Models:
EKF 300.3 - 30°
EKF 450.3 - 45°
EKF 452.3 - 2.5R

Also available:
1.6mm / 0.063"
cutting inserts (SHM 201).
Contact us for details.



Fine adjustment
Precise control of chamfer when deburring for weld seam preparation



0-9/16" (15mm) beveling width

Two Models:
EKF 630 - 30°
EKF 645 - 45°

Standard equipment includes milling head and two inserts, SW22 key, carrying case and user's manual. See our Price List for available accessories.



Specifications	Model EKF 300.3*	Model EKF 450.3*	Model EKF 452.3*	Model EKF 630	Model EKF 645
Beveling Angle	30°	45°	2.5mm (0.098")	30°	45°
Bevel Width (max.)***	1/4"	1/4"	1/4"	9/16"	9/16"
Motor Power	13.5 Amp/110V**			19.1 Amp/110V**	
Cutting Speed	3000 SFPM			1200-1500 SFPM	
Cutting Inserts Qty.	3			20	
Available Inserts (Sold as pack of 10)	SHM200; SHM 200-E (for stainless steel); SHM 202 (2.5mm radius); SHM 201 (1.6mm radius)			SHM 900	
Dimensions	12 ¹ / ₂ " L x 5 ¹ / ₂ " W x 11 ⁵ / ₈ " H			15 ³ / ₄ " L x 13 ¹³ / ₁₆ " W x 11 ¹³ / ₁₆ " H	
Weight	10.5 lbs.			22.5 lbs.	

*Heads are interchangeable *220 V / 50 Hz also available

***Max bevel width may require several passes, depending on material hardness

SKF Beveling Machine for Plates and Pipes

Fast, easy preparation of weld seams and bevels on plate or pipe.

- Bevel 15° to 60° angles and land width up to 3/4" on steel, stainless steel, aluminum and nonferrous metal plates and pipe
- Work on welding angles and weld preparation on pipes/tubes with a minimum OD of 6-1/4" (160mm) with built-in pipe roller guide; ideal for beveling pipe 6-1/4" OD and larger
- Robust design, single operator control and easy handling
- Anti-vibration system for operator comfort



SKF 025



Standard equipment includes one milling head, 10 sintered carbide reversible cutting inserts, tools for assembly, built-in pipe roller guide, steel carrying case and user's manual. Please see our Price List for available accessories.

Cutting Plates - Sold as pack of 20
Part No. **SHM 800 N:** for beveling carbon and stainless steel

SKF Portable Beveler Specifications

Order No.	SKF 025
Beveling Width	3/4" max.***
Motor Power	15 Amp
Voltage	110V (220V / 50 Hz also available)
Cutting Speed	1800 SFPM
Cutting Inserts	10
Dimensions	16 1/2" L x 13" H
Weight	43 lbs.

***Max bevel width may require several passes, depending on material hardness

AutoCUT 500 Automatic Edge Processing Machine

Powerful, self-guiding beveling machine for 15° to 60° edges on plate up to 1.5" thick.



- Bevel 15° to 60° angles and land width up to 1-3/16" on steel, stainless steel, aluminum and nonferrous metal plates and pipe
- Unit propels itself on the plate, no need for a cart or stand
- Automatic feed and return
- Reversible carbide cutting inserts

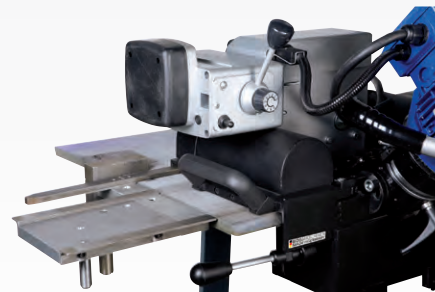
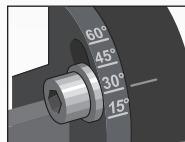
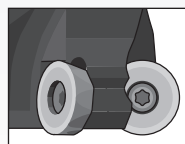

Automatic Edge Processing Machine Specifications

Order No.	AutoCUT 500
Beveling Width	1 3/16" max.***
Motor Power	10 Amp
Voltage	230V, 3-phase
Cutting Speed	2750 SFPM
Cutting Inserts	6
Dimensions	23 1/2" L x 24" W x 20 1/2" H
Weight	110 lbs.



***Max bevel width may require several passes, depending on material hardness

Portable Saws and Accessories

Saws for Pipes, Structural Steel, Profiles and more p. 118-127

Dry Cutting Circular Saws - Pneumatic	p. 118-119
Portable Reciprocating Saws and Blades - Pneumatic, Hydraulic	p. 120-121
Portable Band Saws and Blades - Pneumatic, Electric, Hydraulic	p. 122-123
Power Hacksaws and Blades - Pneumatic, Electric, Hydraulic	p. 124-125
Pipe Cutting Machine - Pneumatic, Hydraulic	p. 126-127

7-1/2" dia. Heavy-Duty Dry Cutting Air Saw

Cut up to 2-1/2" depth at 90° and 1-1/2" at 45°

Air power ideal for petrochemical, marine, demolition and fabrication industries

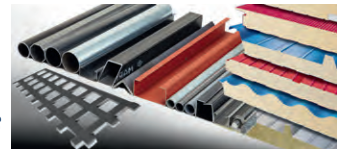

1.7 HP
Air Motor

- Heavy-duty air-powered circular saw, ideal for wet and dirty conditions
- Pneumatic power eliminates burn out from stalls
- 7-1/2" max. blade capacity
- D-handle design with inside trigger and safety lock button to prevent accidental starting



Optional Carbide-Tipped 7" (180mm) Dry Cut Saw Blade

P/N 9 2503 0120, 36T, for standard use - dry cuts metal, plastics and wood

7-1/2" dia. Heavy-Duty Dry Cut Air Saw

Order No.	5 1116 0020
Motor Power	1.7 HP (1.3 kW)
Blade Diameter	7-1/2" (190mm)
Max. Depth of Cut	2-1/2" at 90° / 1-1/2" at 45°
Speed (Free)	3,200 RPM
Air Consumption	53 CFM at 90 PSI
Air Connection	1/2" NPT
Vibration	<2.5 m/s ²
Length, Weight	13-1/2", 19 lbs.

* Model 5 1116 0020 also accepts 7-1/4" dia. blades
Standard equipment includes rip fence and blade wrench. Blade not included.

9" dia. Dry Cutting Air Saw for 90° and 45° Cuts

Dry cut up to 3-1/4" depth and 3/8" thick steel plate



ATEX Certified



- Cut steel, nonferrous metal, plastic, grating, composite and corrugated materials
- Cuts at 90° and 45° angles
- Ideal for petrochemical, marine, demolition and fabrication applications

2 HP Air Motor



9" dia. Dry Cut Air Saw for 90° & 45° Cuts

Order No.	5 1115 0020 N
Motor Power	2 HP (1.5 kW)
Blade Diameter	9"
Max. Depth of Cut	3-1/4" at 90° / 2-1/8" at 45°
Speed (Free)	1,700 RPM
Air Consumption	71 CFM at 90 PSI
Air Connection	1/2" NPT
Vibration	<2.5 m/s ²
Weight	19 lbs.

Standard equipment includes an impact-resistant carrying case and Ultra-Thin LBS blade (P/N 722-23060).

9" diameter
(1" arbor)

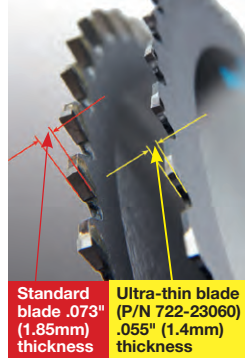

Standard blade .073" (1.85mm) thickness	Ultra-thin blade (P/N 722-23060) .055" (1.4mm) thickness
-----------------------------------------	----------------------------------------------------------

Dry Cutting TCT Saw Blades

9" Laser Beam Saw (LBS) ultra-thin blade for all-purpose use features:

- Thinner than conventional saw blades: LBS = .055" vs. Std. = .073" thickness
- Shock-resistant, less vibration
- Produces 35% fewer chips



Part No.	Teeth	Thickness
722-23060*	60	.055"

* Standard with Model 5 1115 0020 Pneumatic Metal Saw.

Tungsten Carbide-Tipped Dry Cutting Blades, 9" dia., .073" thick for Model 5 1115 0020

P/N 721-23048, 48T, for standard use P/N 721-23068, 68T, for thin-wall metal
P/N 721-23060, 60T, for aluminum P/N 721-23084, 84T, for sheet metal

DRY CUTTING CIRCULAR SAWS - PNEUMATIC

Dry Cutting Circular Saws – Pneumatic

Cut I-beams, 3/8" thick steel plate, insulation boards, sandwich panels, aluminum, plastics and more

- Heavy-duty air-powered circular saw
- Pneumatic power eliminates burn out from stalls and dusty jobsite conditions
- Powerful 2.4 HP motor for demanding applications
- Cuts 3/8" thick steel plate and up to 4-3/4" in other materials
- 12-5/8" max. blade capacity
- Suction nozzle and internal chip collector for clean operation
- D-handle design with inside trigger and safety lock button to prevent accidental starting
- Ideal for steel construction, demolition and more



Model 5 1117 0020 N
4-3/4" max. cutting depth;
Cuts 3/8" thick steel plate



12-5/8" dia. Dry Cut Air Saw

Order No.	5 1117 0020 N
Motor Power	2.4 HP (1.8 kW)
Blade Diameter	12-5/8"
Max. Depth of Cut	4-3/4"
Speed (Free)	1,200 RPM
Air Consumption	71 CFM at 90 PSI
Air Connection	1/2" NPT
Vibration	<2.5 m/s ²
Weight	24 lbs.

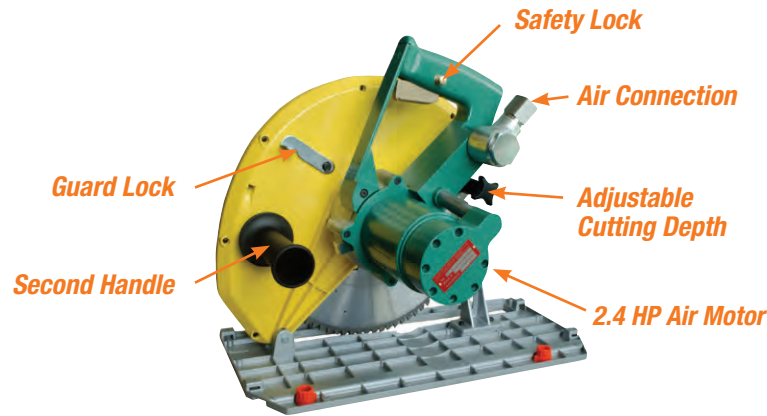

**12-5/8" Dry Cutting
 Saw Blade included
 (P/N 608276).**



Dry Cutting Circular Saw Accessory: Guide Rail with Clamping System (P/N 608275 SET)

Ideal for straight cutting of sandwich panels and sheets, guide rail and clamping system provides secure and jam-free guidance of saw blade through material. Rail provides straight edge length up to 55" (1,400mm).

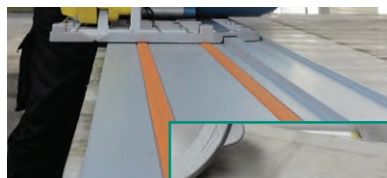

12-5/8" Saw Blades for Model 5 1117 0020

P/N 608276, 84T
 for standard use

P/N 608276SI, 84T
 for stainless steel

Portable Reciprocating Saws Air • Hydraulic

Hand-held or clamp-on cutting in tough environments

Ideal for a wide range of industries, including subsea, gas utilities, offshore oil, petrochemical, power generation, industrial plant maintenance and construction

- Fast cutting of pipe, structural steel, bolts, nails, pallets and other material
- The best power-to-weight ratios in the industry; compact size for cutting in confined spaces

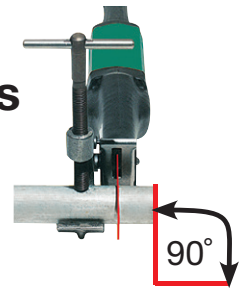

The CAT Model 5 1217 0020

1.3 HP, Cuts steel pipe and channel 1/2" to 6" dia., plastic pipe to 8" dia.

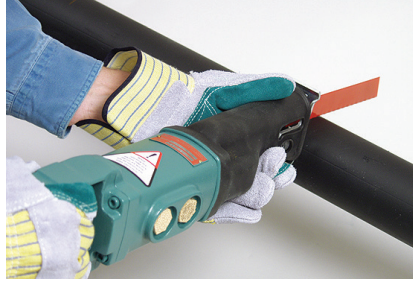

The SHARK Model 5 1219 0010

2 HP, cuts pipe up to 6" dia., wood up to 8" dia., metal plate up to 3/4" dia.



Pipe Vise Clamps for 90° Cutting

Cut faster by increasing your leverage 5x while safely securing the saw.

- For 1/8" - 2" Pipe: Model No. 563 000
- For 2 1/2" - 4" Pipe: Model No. 563 100
- For 4" - 6" Pipe: Model No. 563 200



CAT Saw Kit (5 1217 0070) includes saw, 4" and 6" pipe clamps, case and five No. 1001 heavy-duty blades.



Model Number	Motor Specifications	Stroke Length	Strokes per Minute	Connection	Length	Weight (lbs.)
The CAT – Pneumatic						
5 1217 0020	1.3 HP, 46CFM @ 90 PSI	1-1/8"	0-1800	1/2" NPT (ID)	16"	9
The SHARK – Hydraulic						
5 1219 0010	2 HP, Oil Pressure 2000 PSI, Oil Flow 6 GPM (up to 13 GPM)	1-1/8"	1700	M 18 x 1.5 Female	18"	13.2

Low Vibration/Low Air Volume – Compact, Quiet & Reliable

Workhorses for use in the fabrication, shipbuilding, ship repair, oil and petrochemical, boat building and aircraft maintenance fields, as well as by fire and rescue professionals

- Piston air motors use low air volume while maintaining cutting speed
- Heavy-duty cast steel and aluminum saw bodies; built-in motor lubrication
- Safety STOP/Isolator button disconnects air supply



For use in hazardous areas and around gas and other flammable materials



PL Series



CL Series



Optional inside trigger for hand-held use only. Add FT to Model No.

Model No.	Motor Power (@ 90 PSI)	Stroke Length	Strokes per Minute	Dimensions (LxHxW)	Weight (lbs.)	Connection	Noise Level dB(A)	Vibration Levels m/s ²
PL905	1 HP, 4 CFM	7/8"	2000	11 ³ / ₄ " x 5 ¹ / ₄ " x 1 ⁵ / ₈ "	5.25	1/4" NPT ID	69	1.73
CL50	1 HP, 5.75 CFM	1-3/4"	1200	15 ³ / ₄ " x 5 ¹ / ₄ " x 1 ⁵ / ₈ "	5.5	1/4" NPT ID	83	3.69
CL75	1 HP, 5.75 CFM	1-3/4"	1200	15 ³ / ₄ " x 5 ¹ / ₄ " x 1 ⁵ / ₈ "	5.5	1/4" NPT ID	83	3.69

Models above have outside trigger. Optional inside trigger for hand-held use only – add FT to Model No. (ex: PL905FT)

Reciprocating Saw Blades & Accessories

Super quick and precise for pipe, steel, plastic, etc.

Extra-Thick Blades for 90° Cutting with a Pipe Clamp, Double Shank*

Heavy-duty Blades – These blades are much thicker than standard blades and have a stronger double-tang mount for heavy-duty cutting, either free-hand or with a clamp.

No. 1001	Cuts pipe up to 2"	8 TPI	6" L x 1" W x .060" T
No. 1002	Cuts pipe up to 4"	8 TPI	8" L x 1" W x .060" T
No. 007D/200*	Cuts pipe up to 4"	M-Tooth	8" L x 1" W x .050" T

* 007D/200 has universal 1/2" tang



Ask for special blades to cut steel.

Heavy-Duty HSS Bi-metal Blades for Freehand Sawing, Double Shank

Made of tough, resilient steel with 10/14 variable tooth pitch. Large blade width and double-shank mount deliver excellent cutting performance and durability.



No. 1005	10/14 TPI	6" L x 1" W x .035" T
No. 1003	10/14 TPI	8" L x 1" W x .035" T
No. 1004	10/14 TPI	12" L x 1" W x .035" T

Mega Sharp M-Tooth Saw Blades for Freehand Cutting with Standard 1/2" Shank

CUTS 2x FASTER THAN ORDINARY BLADES! M42 Bi-metal for cutting steel and stainless steel
The teeth of the patented M-Tooth saw blade cut on the forward and back strokes, saving time.

Metal up to 1/8" Thick

No. 006/150	M-Tooth	6" L x 3/4" W x .035" T
No. 006/200	M-Tooth	7" L x 3/4" W x .035" T

Metal 1/8" and Thicker

No. 007/150	M-Tooth	6" L x 3/4" W x .035" T
No. 007/200	M-Tooth	8" L x 3/4" W x .035" T
No. 007/280	M-Tooth	12" L x 3/4" W x .035" T



Cengar Air Saw Blades

1/2" Wide Bi-metal Blades (CL50 / PL905)

HB300/18	Hand	18 TPI	12" L
HB300/24	Hand	24 TPI	12" L
HB300/32	Hand	32 TPI	12" L
MC220/18	Machine	18 TPI	8 ^{3/4} " L
MC220/24	Machine	24 TPI	8 ^{3/4} " L
MYN150/18	Notched Yellow	18 TPI	6" L
MYT150/18	Tapered Yellow	18 TPI	6" L

3/4" Wide Bi-metal Blades (CL75)

MB150/18	Machine	18 TPI	6" L
MB200/10-14	Machine	10/14 TPI	8" L
MB200/18	Machine	18 TPI	8" L
MB200/24	Machine	24 TPI	8" L
MB250/18	Machine	18 TPI	10" L
MB250/24	Machine	24 TPI	10" L
MB300/10-14	Machine	10/14 TPI	12" L
MB300/18	Machine	18 TPI	12" L



AirPac Dryer/Cleaner

Model CSAP-2

- Removes moisture and dirt from air lines; a float valve automatically ejects water and dirt
- Includes automatic oiler; protects tools from freezing in cold environments
- Eliminates air motor downtime caused by water and dirt
- Connections for two tools, max. air flow 185 CFM



Air Tool Lubricant
ProLube-ATL - P/N CS 7043-001 (gallon)

Air Tool Lubricant with Anti-Freeze
ProLube-ATL/AF - P/N CS 7049-001 (gallon)

Air Tool Line Conditioner/Cleaner
For use in underwater air tools – displaces moisture and inhibits rust and corrosion of air motors - P/N MS 9105 (quart)

Hydraulic Power Unit

Model P95

- Ideal for use with our hydraulic power tools.
- Delivers 5 GPM or 8 GPM at 2000 PSI
- Easy to move with lift and latch handle
- Weights 330 lbs.
- 18 HP gas engine



The Hydraulic Power Unit is available with gas, electric or diesel engines. Contact us for more information.

Portable Band Saws Air • Electric • Hydraulic

Fast, on-site cutting of pipe up to 8" diameter

Cold cutting saws for industry, including refineries, chemical plants, utilities, construction, offshore oil, mining, marine and demolition



Pneumatic AirBand™ Saws



Standard:
Cut 4³/₄" round or 4¹/₂" x 4³/₄"



5 6093 0010:
Cut 4" round or 4" x 4"
Includes stationary cutting table and vise



Deep Throat™:
Cut 7" round or 7" x 7"

Wide Mouth™:
Cut 8" round or 9" x 8¹/₂"

Electric Band Saws



Standard:
Cut 4" round or 4" x 4"

Deep Throat™:
Cut 7" round or 7" x 7"

Wide Mouth™:
Cut 8" round or 9" x 8¹/₂"

Hydraulic Band Saws

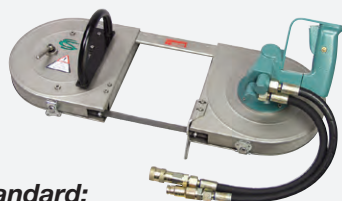

Standard:
Cut 4" round or 4" x 4"

Deep Throat™:
Cut 7" round or 7" x 7"

Wide Mouth™:
Cut 8" round or 9" x 8¹/₂"

- Fast, deep, cold cutting of pipe, conduit, bolts, cable, angle iron, structural steel, chain and more
- Cut steel, stainless steel, Inconel, chrome, Hastelloy, aluminum, copper, iron, fiberglass, plastics, wood and more
- Vise clamps available for straight cutting of round, square and angular materials

Pneumatic Band Saws

Model No.	Cutting Capacity	Motor Power	Blade Speed (ft/sec)	Overall Length	Wt. (lbs.)
Standard AirBand™ – Aluminum Housing; 1/4" NPT ID Air Connection; 3/8" Air Hose					
5 6003 0011	4 ³ / ₄ " OD / 4 ¹ / ₂ " x 4 ³ / ₄ "	90 PSI @ 20 CFM	2.2-3.3 (var.)	21 ¹ / ₂ "	14
5 6093 0010	4" OD / 4" x 4"	90 PSI @ 19 CFM	5.75	25"	17*
Deep Throat™ AirBand – Stainless Steel housing; 1/2" NPT ID Air Connection; 1/2" Air Hose					
5 6031 0010 N	7" OD / 7" x 7"	90 PSI @ 43 CFM	4.0-4.9 (var.)	28 ³ / ₄ "	28
Wide Mouth™ AirBand – Stainless Steel housing; 1/2" NPT ID Air Connection; 1/2" Air Hose					
5 6062 0010	8" OD / 9" x 8 ¹ / ₂ "	90 PSI @ 43 CFM	4.0-4.9 (var.)	30 ³ / ₄ "	35

* Weight of saw only. Weight of saw, stationary cutting table and vise is 48 lbs.

Electric Band Saws

6 Amp, 220VAC

Model No.	Cutting Capacity	Blade Speed (ft/sec)	Overall Length	Wt. (lbs.)
Standard – Aluminum housing; Includes stationary cutting table and vise				
5 6020 0010-220	4" OD / 4" x 4"	3.3/4.4 (2 speeds)	25"	18**
Deep Throat™ – Stainless Steel housing				
5 6078 0010-220	7" OD / 7" x 7"	2.0-4.9 (var.)	28 ³ / ₄ "	28
Wide Mouth™ – Stainless Steel housing				
5 6079 0010-220	8" OD / 9" x 8 ¹ / ₂ "	2.0-4.9 (var.)	30 ³ / ₄ "	34

** Weight of saw only. Weight of saw, stationary cutting table and vise is 40 lbs.

Hydraulic Band Saws

1.6 HP; Oil Flow: 4 GPM @ 2000 PSI; 1/2" FF (HTMA) Couplings

Model No.	Cutting Capacity	Blade Speed (ft/sec)	Overall Length	Wt. (lbs.)
Standard – Stainless Steel housing				
5 6043 0010	4" OD / 4" x 4"	4.2	22"	23
Deep Throat™ – Stainless Steel housing				
5 6041 0010	7" OD / 7" x 7"	4.2	28 ³ / ₄ "	28
Wide Mouth™ – Stainless Steel housing				
5 6054 0010	8" OD / 9" x 8 ¹ / ₂ "	4.2	30 ³ / ₄ "	35.6

Optional blade guards available for CS Unitec Band Saws

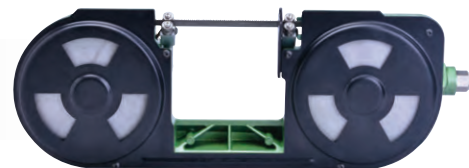

Portable Band Saw Blades and Accessories

M42 Cobalt Steel SuperBand™ Saw Blades

Blades for Models 5 6093 0010 and 5 6020 0010-220 (3/pk.)

Exact blade dimensions: 1335mm L x 13mm W x .65mm T

No. 9 2506 0690	24 TPI	Cuts material 1/8" - 1/4" thick
No. 9 2506 0680	18 TPI	Cuts material 3/16" - 1/2" thick
No. 9 2506 0660	10/14 TPI*	Cuts material 3/16" - 1/2" thick
No. 9 2506 0650	8/12 TPI*	Cuts material 1/2" and thicker

52.56"

Blades for Model 5 6003 0011 and 5 6043 0010 (per pc.)

Blade dimensions: 44 7/8" L x 1/2" W x .025" T

No. 9 2506 0010	18 TPI	Cuts material 1/8" - 1/4" thick
No. 9 2506 0020	14 TPI	Cuts material 3/16" - 1/2" thick
No. 9 2506 0030	10/14 TPI*	Cuts material 3/16" - 1/2" thick
No. 9 2506 0040	8/12 TPI*	Cuts material 1/2" and thicker

44 7/8"

Deep Throat™ Blades (Models 5 6031 0010, 5 6040 0010-220 and 5 6041 0010) (per pc.)

Blade dimensions: 66" L x 5/8" W x .025" T

No. 9 2506 0220	14 TPI	Cuts material 3/16" - 1/2" thick
No. 9 2506 0230	10/14 TPI*	Cuts material 3/16" - 1/2" thick
No. 9 2506 0240	8/12 TPI*	Cuts material 1/2" and thicker
No. 9 2506 0200	8 TPI	Cuts material 3/4" and thicker

66"

Wide Mouth™ Blades (Model Nos. 5 6062 0010, 5 6079 0020-220 and 5 6054 0010) (per pc.)

Blade dimensions: 71" L x 5/8" W x .025" T

No. 9 2506 0350	10/14 TPI*	Cuts material 3/16" - 1/2" thick
No. 9 2506 0340	8/12 TPI	Cuts material 1/2" and thicker
No. 9 2506 0330	6/10 TPI	Cuts material 3/4" and thicker

71"

* Variable tooth pitch (10/14 TPI and 8/12 TPI) saw blades cut faster and last longer than standard pitch blades. Varying tooth size and gullet depth reduce harmonic vibration for quieter, more efficient cutting.

Vise Clamps for Accurate Cuts

- Securely clamp to round, square and angular materials for straight cutting
- Easily attach to CS Unitec Portable Band Saws

Clamp-on vise for 4-3/4" Band Saws

Model No. 5 6030 9000

(for saw 5 6043 0010)

Max. material size – rounds: 4 3/4"; squares: 4 1/2"; angles: 4 1/2"

Clamp-on vise for 7" Deep Throat™ Band Saws

Model No. 5 6031 9400

(for saw 5 6031 0010, 5 6078 0010-220 and 5 6041 0010)

Max. material size – rounds: 7"; squares: 5"; angles: 5"

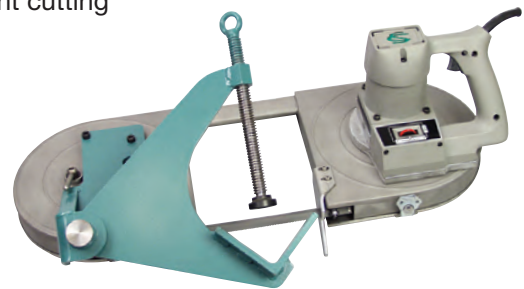

Power Hacksaws Air • Electric • Hydraulic

Cold cutting of large pipe up to 30" diameter and structural steel – on site

Ideal for a wide range of industries, including refineries, chemical plants, utilities, construction, offshore oil, mining, marine and demolition

- Cold cutting of large pipe, structural steel, tanks, profiles and more
- Compact size for cutting in confined spaces
- Accessories include wide variety of heavy-duty blades and clamps for 90° cuts



Model 5 1212 0050

AIR



Model 5 1215 0070

ELECTRIC



Model 5 1220 0050

HYDRAULIC



Model No.	Power	Throttle	Motor Specifications	Strokes per Min.	Blade Stroke	Hose	Wt. (lbs.)
Pneumatic – 3/4" ID NPT Air Connection							
5 1212 0010	1.5 HP	Roll	Air Consumption: 51 CFM Air Pressure: 90 PSI	100-350	2 ³ / ₈ "	1/2"	15.4
5 1212 0050	1.5 HP	Lever		100-350	2 ³ / ₈ "	1/2"	15.4
Electric – 11 Amps / 110 Volt (Also available as 220 Volt/50 Hz)							
5 1215 0070	1.5 HP	Trigger	110V/60 Hz	200-400	2 ³ / ₈ "	Cable	13
Hydraulic – 1/2" FF (HTMA) Couplings							
5 1220 0050	3.8 HP	Lever	Oil Flow: 4 GPM at 2000 PSI	100-500	2 ³ / ₈ "	1/2" ID	13.5

Throttle Types for Pneumatic Saws:



Roll Throttle

(air model 5 1212 0010 only) – used only with automatic feed pipe clamp (see next page)

Lever Throttle

(model 5 1212 0050) – provides on/off paddle switch for manual cutting with clamp

Carrying Case

Optional metal carrying case for all hacksaws.

Order no. 9 9910 0080

Assorted pipe clamps for pipes up to 30" OD or profile clamps for structural steel

Manual or automatic feed

Heavy-duty saw blades from 8" to 37" long

HSS, HSS-SL, and carbide-coated blades available

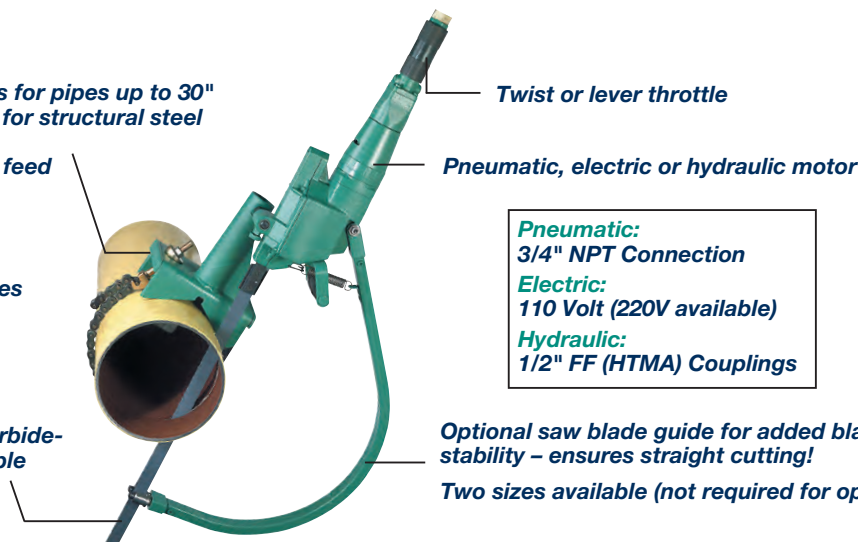

Pneumatic:
3/4" NPT Connection
Electric:
110 Volt (220V available)
Hydraulic:
1/2" FF (HTMA) Couplings

Optional saw blade guide for added blade stability – ensures straight cutting!
Two sizes available (not required for operation)

PORTABLE POWER HACKSAWS

Power Hacksaw Blades and Accessories

Hacksaw Blades – 8" to 37" length

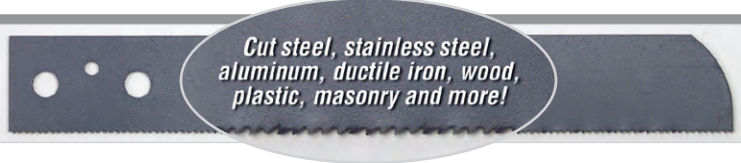

Order No.	Dimensions			Material	Max. Dia. of Cut
	Length	Teeth/Inch	Thickness		
Z22-9 HSS	8"	8	1/16"	Steel/Aluminum	3 1/8"
Z22-10 HSS	8"	16	1/16"	Steel	3 1/8"
Z22-11 HSS	8"	24	1/16"	Sheet Metal	3 1/8"
Z22-6 HSS	12"	16	1/16"	Steel	6 5/8"
Z22-6 HSS-SL*	12"	16	1/16"	Stainless Steel	6 5/8"
Z22-31 HSS	12"	12	1/16"	Steel	6 5/8"
Z22-7 HSS	16"	16	1/16"	Steel	10 5/8"
Z22-29 HSS	16"	8	1/16"	Steel/Aluminum	10 5/8"
Z22-33 HSS	16"	6	1/16"	Cast Iron	10 5/8"
Z22-72 HSS	20"	14	5/64"	Steel	14 5/8"
Z22-30 HSS	21"	12	1/16"	Steel	15 5/8"
Z22-30 HSS-SL*	21"	12	1/16"	Stainless Steel	15 5/8"
Z22-73 HSS	24"	14	5/64"	Steel	18 1/2"
Z22-74 HSS	24"	8	5/64"	Steel/Aluminum	18 1/2"
Z22-75 HSS	30"	12	5/64"	Steel	24 7/8"
Z22-75 HSS-SL*	30"	12	5/64"	Stainless Steel	24 7/8"
Z22-76 HSS	30"	6	5/64"	Cast Iron	24 7/8"
Z22-37 HSS	37"	12	5/64"	Steel	31 7/8"

* Use HSS-SL Blades for best cutting performance on stainless steel and hard metal. Blades for plastic, wood and masonry also available.

Hacksaw Clamps and Blade Guides

Model No.	Cutting Diameter	Description
5 1207 9910	2" to 6"	Pipe Clamp
5 1202 9960	4" to 12 3/4"*	Pipe Clamp
5 1207 9970	Up to 13" OD	Blade Guide
5 1207 8910	Up to 21" OD	Blade Guide
5 1207 8970	21 5/8" x 11 3/8"	Profile Clamp
5 1208 9980	Up to 12 3/4"*	Automatic - Self-feeding Clamp (for pneumatic saws)
5 1208 9990	Up to 12 3/4"*	Automatic - Self-feeding (for electric and hydraulic saws)



Model 5 1202 9960 Pipe Clamp for 4" to 12 3/4" dia.*



Model 5 1208 9990 Self-feeding Pipe Clamp for up to 12 3/4" dia. electric and hydraulic saws*

* Cut up to 30" OD with two extension chains (order 2x P/N 5 1201 9030)

ProLube™ Lubricants

Cutting tools work cooler, longer and more efficiently. Ideal for cutting steel, stainless steel and hard metals.

- Prolong tool life by reducing friction and wear
- Unique composition provides excellent adhesion to cutting tools for maximum lubrication
- Corrosion inhibitor
- Ideal for saw blades and drill bits
- Non-toxic



ProLube Paste

CS 7030-712
12 oz. tub

ProLube Solid

CS 7020-013
1.6 oz. push tube
CS 7020-000
14.5 oz. push tube

ProLube Liquid

Water soluble 16:1
CS 7010-504
1 gal. bottle



Pipe Cutting Machine



ATEX Certified

Cut pipe up to 63" dia. with wall thickness up to 2"

Ideal for use in municipal water and gas utilities, petrochemical, power generation, plant maintenance, pipe line construction, marine and demolition applications.

- Heavy-duty, versatile air and hydraulic pipe cutting machines
- Cut pipe quickly from 6" to 63" dia. with wall thicknesses from 1/4" to 2"
- Use on steel, ductile iron, nonferrous metal, HDPE, plastic, concrete pipe and more
- Cut pipe underground with minimal excavation
- 7" blade with adjustable cutting depth and fully enclosed blade guard
- Machine is manually guided with hand lever feed to make a 360° cut in pipe at 90 degrees
- Guide chain is adjustable by adding and removing chain links
- ATEX certified for use in Ex Zones (ATEX II 2 GcT6)

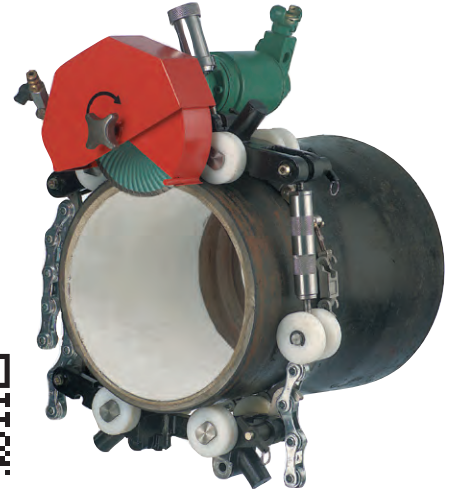

*Pneumatic Model
No. 5 8010 0050*

Features include:

- **Fast cutting of pipe**
- **Adjustable cutting depth**
- **Fully enclosed blade guard**
- **Cooling water connection**
- **Carbide-tipped or diamond-coated blades**

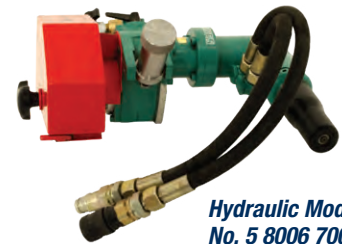

*Hydraulic Model
No. 5 8006 7000*

When ordering, specify pipe diameter and application for assistance with determining required blade, feed handle, guide carriage & chain and tensioning chain & tensioner.

Model Number	Power	Blade Arbor	Motor Specifications	Speed (RPM)	Blade Dia.	Hose Connection	Weight (lbs.)
Pneumatic Motor							
5 8002 7000	2.4 HP	7/8"	77 CFM @ 90 PSI	350/1800	7"	1/2" NPT	28
5 8010 0050	4 HP	7/8"	106 CFM @ 90 PSI	1800	7"	3/4" NPT	28
Hydraulic Motor							
5 8006 7000	4 HP	7/8"	6-13 Gallons @ 2000 PSI	350/1800	7"	1/2" FF (HTMA)	28

Pipe Cutting Machine

Pipe Cutting Machine Kits

For Pipe Diameters	Pneumatic Kit Part No.	Hydraulic Kit Part No.
6" to 16" (150-400mm)	5 8010 16PK	5 8006 16HK
6" to 32" (150-800mm)	5 8010 32PK	5 8006 32HK
6" to 63" (150-1600mm)	5 8010 63PK	5 8006 63HK

For a list of contents included with hydraulic kits, visit our website at: www.csunitec.com/saws/pipe-cutting-machines

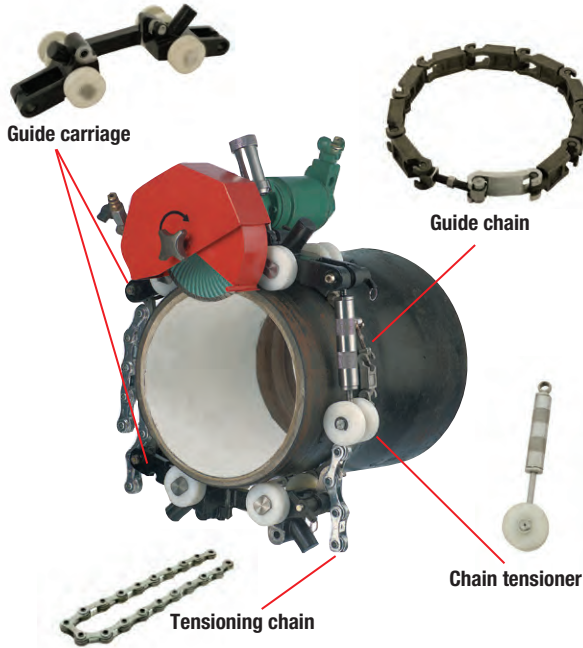

Pneumatic Kits



Select Appropriate Kit Based on Pipe Diameter
For cutting pipe with diameter greater than 63", please contact CS Unitec for help identifying necessary components.

6" to 16" (150-400mm)	6" to 32" (150-800mm)	6" to 63" (150-1600mm)
Kit 5 8010 16PK	Kit 5 8010 32PK	Kit 5 8010 63PK
(1) Drive Unit P/N 5 8010 0050	(1) Drive Unit P/N 5 8010 0050	(1) Drive Unit P/N 5 8010 0050
(1) Guide Carriage, small P/N 5 8010 8090	(1) Guide Carriage, small P/N 5 8010 8090	(2) Guide Carriage, small P/N 5 8010 8090
(1) Chain Tensioner, small PN 5 8003 8300	(1) Chain Tensioner, small PN 5 8003 8300	(1) Chain Tensioner, small PN 5 8003 8300
(1) Guide Chain, 16" OD (24 chain links) P/N 5 8002 8760	(1) Guide Carriage, large P/N 5 8010 8100	(2) Guide Carriage, large P/N 5 8010 8100
(1) 7" Dia. Carbide-tipped blade P/N 9 2503 0120	(1) Chain Tensioner, large P/N 5 8002 8400	(2) Chain Tensioner, large P/N 5 8002 8400
(1) 7" Dia. Diamond blade P/N 9 2503 0100	(1) Tensioning Chain P/N 5 8002 8710	(2) Tensioning Chain P/N 5 8002 8710
(1) Tool Kit P/N 5 8002 9200	(1) Guide Chain, 32" OD (46 chain links) P/N 5 8002 8780	(1) Guide Chain, 63" OD (90 chain links) P/N 5 8002 8830
(1) Steel Transport Box P/N 5 8002 9300	(1) 7" Dia. Carbide-tipped blade P/N 9 2503 0120	(1) 7" Dia. Carbide-tipped blade P/N 9 2503 0120
	(1) 7" Dia. Diamond blade P/N 9 2503 0100	(1) 7" Dia. Diamond blade P/N 9 2503 0100
	(1) Tool Kit P/N 5 8002 9200	(1) Tool Kit P/N 5 8002 9200
	(1) Steel Transport Box P/N 5 8002 9300	(1) Steel Transport Box P/N 5 8002 9300

Guide Chain

All guide chains include tightener

Part No.	Description
5 8002 8760	24 chain links
5 8002 8770	35 chain links
5 8002 8780	46 chain links
5 8002 8810	57 chain links
5 8002 8790	68 chain links
5 8002 8820	79 chain links
5 8002 8830	90 chain links



	Chain Link Part No. 5 8001 8750 (Length: 2-1/4")
	Chain Link Set (5 connected links) Part No. 5 8001 8860 (Length: 11-1/4")
	Tightener – Part No. 5 8002 6800

Tensioning Chain

Small Chain Tensioner
Part No. 5 8003 8300

	Large Chain Tensioner Part No. 5 8002 8400		Tensioning Chain Length: 37-3/8" (950mm) Part No. 5 8002 8710
-------------------------------------------------------------------------------------	------------------------------------------------------	-------------------------------------------------------------------------------------	----------------------------------------------------------------------------

Guide Carriages

	Small Guide Carriage – Part No. 5 8010 8090
	Large Guide Carriage – Part No. 5 8010 8100
	Feeding Pipe – Part No. 5 8002 9500

7" Saw Blades – for 2" max. cutting depth

	Carbide-Tipped Blade Part No. 9 2503 0120 For steel, stainless steel (min. 1/4" wall thickness), plastics, HDPE and PVC		Diamond Blade Part No. 9 2503 0100 For cast iron, ductile iron, cement, concrete and clay
-------------------------------------------------------------------------------------	---------------------------------------------------------------------------------------------------------------------------------------------------	---------------------------------------------------------------------------------------	---------------------------------------------------------------------------------------------------------------------

View a demonstration
of our versatile pipe
cutting machine:

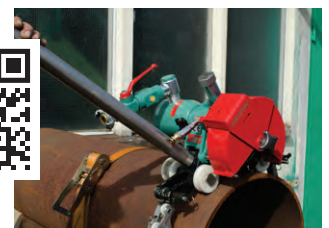

Also Available from CS Unitec

CS Unitec, Inc. specializes in industrial power tools and safety tools for construction and industry.

Innovation and high quality are synonymous with CS Unitec's power tools. In 1991, the company invented the first pneumatic portable band saw. CS Unitec has added to its list of industry firsts with the widest range of portable magnetic drills and hand-held concrete core drills. The line also includes surface preparation tools for metal, concrete and masonry, air, electric and hydraulic portable band saws, reciprocating saws, hacksaws, nut runners, rotary hammer drills, rolling motors, non-sparking safety tools, portable mixers and dust extraction vacuum systems.

For tool specifications and ATEX and Ex Zone information, visit www.csunitec.com.

Call 1-800-700-5919 or 203-853-9522 to request any of the catalogs shown below.



Concrete Tools:

Surface Preparation Tools, Concrete Grinders, Dust Collection Systems, Diamond Core Drills, Air Concrete Saws and more



View demo videos at www.csunitec.com



Metalworking Tools:

Surface Preparation Tools, Dust Collection Systems, Dry Cutting Portable Saws, Portable Magnetic Drills, Bridge Reamers and more



Portable Mixers:

Portable Mixing Machines for Mortar, Concrete, Plaster, Flooring Adhesives, Grout, Coatings, Paint, Self-Leveling Compounds and more



Portable Saws:

Hacksaws, Reciprocating Saws, Band Saws, Chain Saws, Cut-off Saws and more

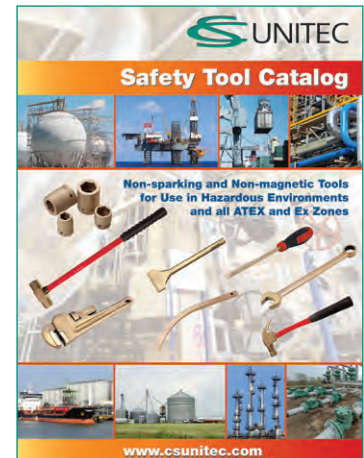

Non-Sparking Hand Tools:

Non-Sparking Hand Tools Power Tools for use in Ex Zones, ATEX Zones and Hazardous Environments



CS UNITEC, Inc. 22 Harbor Avenue, Norwalk, CT 06850
4330 Center St., Deer Park, TX 77536

Phone 800-700-5919 • 203-853-9522 • Fax 203-853-9921

Email info@csunitec.com • www.csunitec.com

 View product demonstrations at www.csunitec.com.

ALL SPECIFICATIONS ARE SUBJECT TO CHANGE

© Copyright 2019, CS Unitec, Inc., 10-19-10M

IDEMCO

W : www.idemcosb.com.my

E : idemco@idemcosb.com.my

T : +6 03-7781 7973