



CABLE-SHEATH STRIPPERS



760

Cable-sheath strippers.....	760
Longitudinal/helicoidal cable-sheath stripper	761
Multifunction sheath strippers.....	762
Coax cable-sheath strippers	762

WIRE STRIPPERS



763

Automatic wire stripper.....	763
Automatic lateral wire strippers	764
Automatic cutting strippers.....	764
End wire strippers.....	765

CRIMPING PLIERS



766

For pre-insulated terminals.....	766
For tubular terminals and sleeves	769
Crimping dies	770
For open cylinder connectors	771
For wire tips.....	771
For transmission connectors	772
Terminal sets	773

WIRING TOOLS



774

Sleeving pliers	774
Plastic cable-tie pliers.....	774
Glue gun	775
Wrenches for cabinet.....	775

WIRE PULLER AND ACCESSORIES

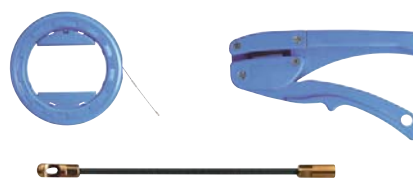

776

Nylon rods	776
Glass fibre rods.....	777
Accessories	777
Consumables for nylon and glass fibre rods.....	778
Accessories for nylon steel rods.....	779

PUNCHES



780

Standard hole punches with PG circular cutout	781
Standard hole punches with ISO circular cutout	782
Hydraulic devices for hole punches.....	784
Accessories	785
Hole punch sets.....	786

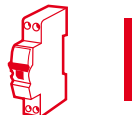
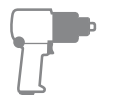
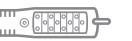

PHYSICAL MEASUREMENT

788



Testers.....	788
Thermometer.....	789

VE SERIES 1,000 VOLT INSULATED PLIERS

790



Diagonal cutters	790
End cutters	791
Half-round nose pliers	791
Standard multigrip pliers	792
Combination pliers	792
Flat nose pliers	793
Round nose pliers	793
Standard wire strippers	793

VE SERIES 1,000 VOLT INSULATED SCREWDRIVERS

794



Insulated screwdrivers for slotted head screws.....	794
Insulated screwdrivers for Phillips® screws.....	794
Insulated screwdrivers for Pozidriv® screws.....	795
Insulated screwdriver sets	795

VSE SERIES 1,000 VOLT INSULATED TOOLING

796



Multigrip pliers	797
Cutters	797
Combination pliers	798
Grip pliers	798
Wire stripper	799
Cable cutters	800
Hacksaw frame	800
Knife.....	801
Open-end wrenches	801
Ring wrenches.....	801
Adjustable wrenches	802
Offset keys	802
Box wrenches	802
1/4" sockets	803
1/4" ratchets and accessories	803
1/4" sockets and accessories sets.....	804
3/8" sockets	804
3/8" ratchets and accessories	805
3/8" sockets and accessories sets	806
1/2" sockets	806
1/2" ratchets and accessories	807
1/2" sockets sets.....	808
Insulated gloves	809
Safety overgloves	809
Insulated mats.....	810
Insulated pliers	810
Insulated tool sets	810

Cable-sheath strippers

MULTIFUNCTION SHEATH STRIPPER

Easy sheath stripping trigger for 30% less effort



PVC cables
Ø 4>28 mm

Pivoting blade for faster and easier sheath stripping



Easy blade change

- Easy blade change by pressing the release and locking point.



DOUBLE SAFETY

- Cutting blade out => trigger locked.
- Stop blade.



- | | |
|---------------------------------------|------------------------|
| ① Trigger system. | ⑥ Stripping point. |
| ② Adjustment screw. | ⑦ Spare pivot blade. |
| ③ Pivoting blade. | ⑧ Pivot blade locking. |
| ④ + ⑤ Double safety. | ⑨ Pivot blade release. |
| ④ Cutting blade out=> trigger locked. | |
| ⑤ Stop blade. | |



Ergonomic comfort grip handle

872271 Multifunction trigger sheath-stripper



- Trigger system: 30% less effort.
 - Self-swivelling blade: fast and easy sheath removal.
 - Double safety:
 - Cutting blade out = trigger locked.
 - Lock back blade.
 - Capacity: round PVC cable 4 to 28 mm diameter.
 - Stripping zone.
- Weight: 150 g.

872272: set of 6 spare blades (5 self-swivel blades and 1 knife blade).

PIVOTING BLADE SHEATH STRIPPER



Extended hook for easy cable placing.



Easy, handy thumb wheel adjustment.



Ergonomic "low effort" push-button.



Rounded handle for a perfect grip.

Jivare



Sheath strippers



985951



985955



985956

- "Effort reducer" push button.
- Spare blade stored in the handle.
- Easily accessible adjustment knob.
- Self-swivel blade.
- 985955 straight blades.
- 985956 hooked blades.

986061: Set of 5 auto-swivel blades for sheath strippers
985951 - 985952 - 985953 - 985954 985955 - 985956.

Code	Capacity Cubic Ø maxi [mm]	ΔΔ [g]
985951	16	65
985952	28	65
985953	35	65
985954	50	65
985955	28	75
985956	28	75

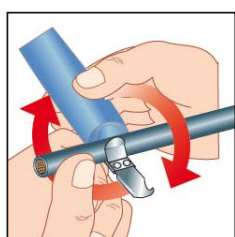
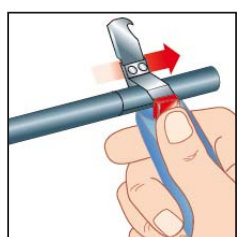

Longitudinal/helicoidal cable-sheath stripper

985957 Rotary sheath and insulation stripping tool

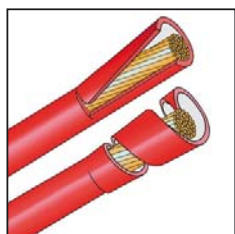
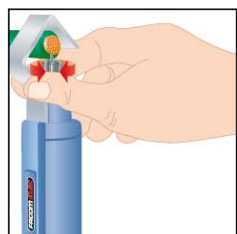

- Tool perfectly suited to stripping sheaths over long lengths.
- 2 possibilities of use:
 - Longitudinal sheath stripping.
 - Helicoidal sheath stripping by simple head rotation.
- Capacity: diameter 4.5 to 29 mm.
- Length: 137 mm.
- Weight: 97 g.

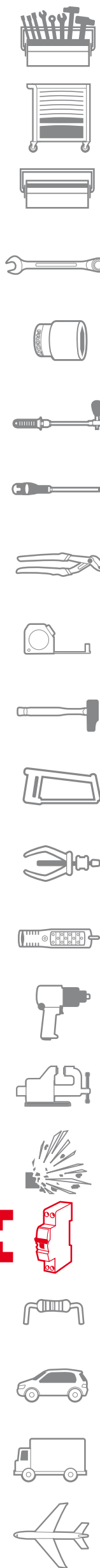

Cable-sheath strippers

Multifunction sheath strippers

■ 985962 Multifunction sheath stripper



- Ideal for stripping sheaths on cables at the bottom of embedding boxes.
 - Allows for stripping without prior adjustment.
 - Also allows for stripping coax cables.
 - Sheath stripping: diameter 4 to 13 mm.
 - Stripping: section 0.5 to 16 mm².
 - Coax cables: diameter 4 to 8 mm.
- Weight: 90 g.

■ 985936 Coax and multipair cable sheath stripper and stripper



- Tool facilitating sheath stripping of coax and twisted multipair (UTP and STP) cables and optical fibers.
 - Capacity: diameter 11 mm.
- Weight: 35 g.

Coax cable-sheath strippers

■ 985964 Sheath and insulation stripper for coaxial and twisted-pair cables



- 2 useful sides:
 - Sheath stripping.
 - Stripping.
 - Capacity: diameter 4.8 to 7.5 mm.
- Weight: 26 g.

■ 838.CX58 Strippers for coax cables types RG.58, RG.59 and RG.62



- Stripper pre-adjusted to strip coax cables in a single operation.
- Stripping obtained allows direct fitting of BNC connectors used in computing, video, radio-telephony.
- Compact, non adjustable without tool.
- Reversible blade cassette doubling the time of use, supplied with calibration shim.

838.CX58L: Spare blade cassette.

Automatic wire strippers

AUTOMATIC WIRE STRIPPER

THE ALL-PURPOSE STRIPPER!

One tool for cutting and stripping wires from 0.02 to 10 mm².

- Adjustable stripping depth.
- Soft grips.
- Jaw force adjustment according to temperature conditions: indoors or outdoors working, hard or soft insulation.
- Mechanism designed for smooth, effortless wire stripping.
- Very easy blade change.



Tested to 150,000 cycles



■ **793936 SWINGO® automatic stripper**



- 2 functions: cutting and stripping.
 - Play take-up mechanism for smooth and easy stripping.
 - Stripping capacity: 0.02 to 10 mm² (AWG: 32 - 8).
 - Stripping length adjusted from 3 to 18 mm.
 - Built-in cutting function:
 - Cutting up to: 1.5 mm² single strand wire.
 - Cutting up to: 10 mm² multi strand wire.
 - Ergonomic body in glass charged nylon.
- Weight: 136 g.

793207: Spare jaw.
793210: Set of 2 spare pads.

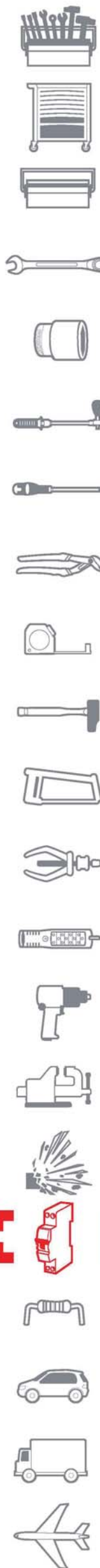

Automatic lateral wire strippers

Automatic lateral wire strippers

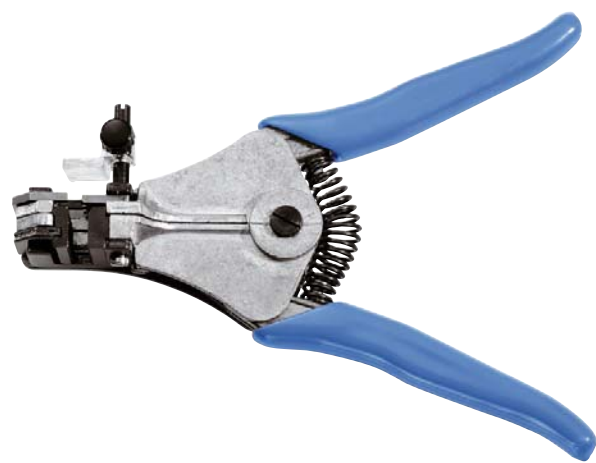

- These strippers offer high precision stripping with a diameter suited to each conductor.

175.E: Spare knife for 986058.

175.T: Spare knife for 986059.

Pattern	ΔΔ [g]
986058 Ø : 0,6 - 0,8 - 1,0 - 1,2 - 1,6 - 2,0 - 2,5 mm ²	370
986059 Ø : 2,0 - 2,4 - 3,1 - 4,0 mm ²	370

165.1 High precision strippers for Teflon insulators



- High precision to cut the insulator circularly without damaging the conductor.
 - Offset jaws designed to avoid marking insulators.
 - AWG: 26 - 24 - 22 - 20 - 18 - 16.
 - Die diameter: 0.55 - 0.65 - 0.82 - 1.05 - 1.30 - 1.55 mm.
- Weight: 370 g.

165.U: Spare knife.

Automatic wire cutters-strippers

985761 Automatic wire cutter-stripper



- For single or multiple strand with automatic adjustment to wire diameter.
 - 1 tool only, 1 gesture for 2 operations:
 - Cutting.
 - Stripping.
 - Stripping capacity: 0.4 to 4 mm²
 - Stripping length adjusted by button: 4 to 17 mm.
 - Cutting diameter: 0.7 to 2.3 mm.
 - AWG: 21 - 11.
 - Length: 160 mm.
- Weight: 340 g.

162-L1: Spare knives.

985762 Dual automatic wire cutter-stripper

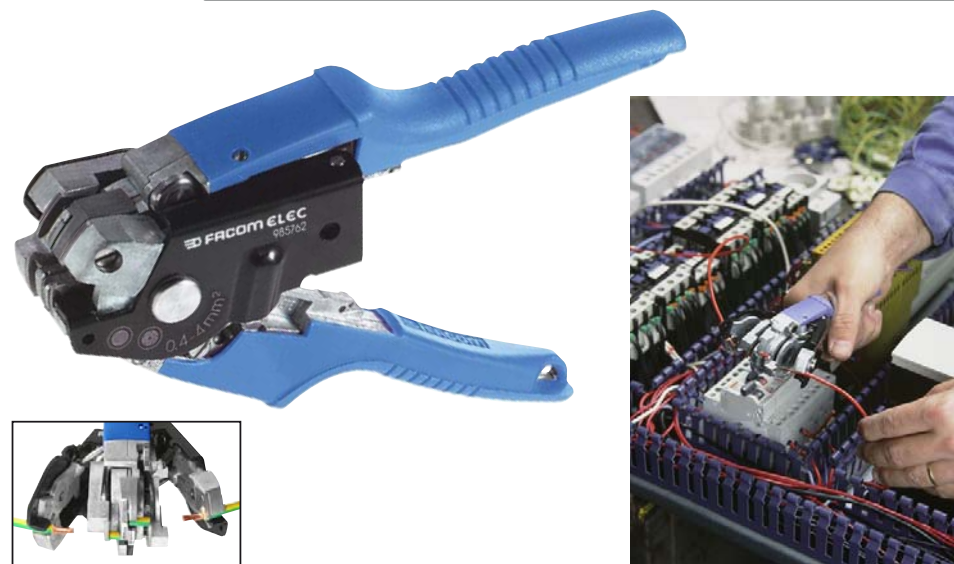

- Allows to cut and strip the wire on both sides for fast wiring operations.
 - The wire is pre-stripped automatically at the right length.
 - Stripping capacity: 0.4 to 4 mm².
 - Stripping length adjusted by button: 4 to 17 mm.
 - Cutting diameter: 0.7 to 2.3 mm.
 - AWG: 21 - 11.
 - Length: 160 mm.
- Weight: 430 g.

162-2L1: Spare knives.

163 Wire cutter and stripper



- For multistrand cutting and stripping:
- Diameter: 1.0 - 1.3 - 1.7 - 2.0 - 2.4 - 3.0 mm.
- Section: 0.8 - 1.3 - 2.3 - 3.0 - 4.5 - 7.0 mm².
- AWG: 20 - 18 - 16 - 14 - 12 - 10.
- 6 dies calibrated by grinding.
- End nipper.
- Return and lock spring.
- Length: 150 mm.
- Weight: 115 g.

End wire strippers

194.12 Extra-slim wire strippers



- For single and multistrand wires:
- Max diameter: 1.5 mm.
- Max section: 1.8 mm².
- Max AWG: 14.
- Narrow knives.
- Cutting depth adjusted by end stop.
- Length: 130 mm.
- Thickness: 4 mm.
- Finish: burnished, PVC grip.
- Weight: 70 g.

Wire strippers

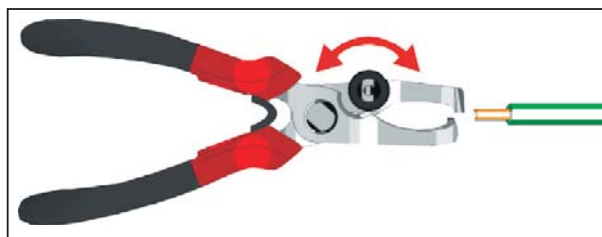
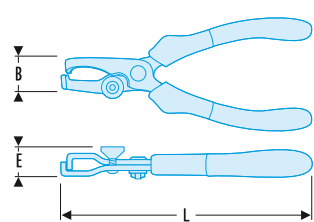

- For single or multiple strand wires 0.5 to 6 mm².
- Adjustment screw with lock nut.
- Metal return screw.
- Standard forged pliers.

➤	B [mm]	E [mm]	L [mm]	ΔΔ [g]
194.17CPE	17	8,5	170	185

173A Coated wire strippers



- Treated steel blades.
- Plastic stops avoiding hand fatigue.
- Finish: burnished blades.
- Dimensions: L.135 x W.10 mm.
- Weight: 40 g.

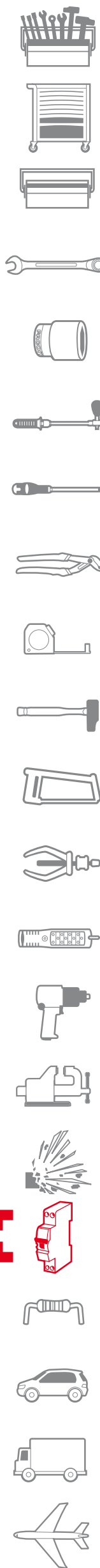

Pre-insulated terminal crimping pliers

PRE-INSULATED TERMINAL CRIMPING PLIERS

The 3-in-1 pliers to cut, strip and crimp

- New multi-function pliers: one tool to cut, strip and crimp wire ends, insulated terminals as well as open core terminals.

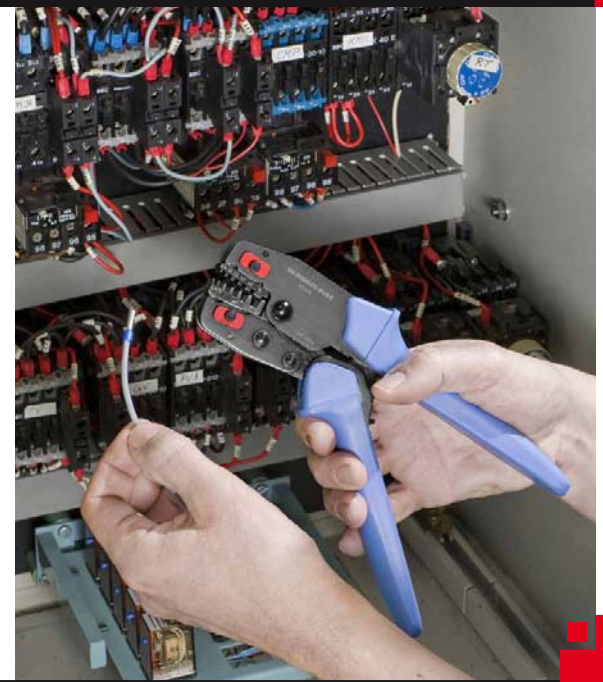

821415 Interchangeable multifunction crimping pliers



- The 3 in 1 pliers: cuts, strips, and crimps.
- Crimping system with ratchet for a perfect result, unlocking always possible.
- Ultra simple crimping die change.
- Once fitted, the dies are held by pins, no risk of escape.
- Crimps:
 - Cable terminations from 0.14 to 10 mm².
 - Pre-insulated terminals 0.5 to 6 mm².
 - Open core terminals 0.5 to 6 mm².
- Cuts flexible wires up to 6 mm².
- Strips from 0.5 to 6 mm².
- Dimensions: L.250 x H.35 x W.75 mm.
- Weight: 496 g.

821440 Cable termination die



DIN 46247

- 6 cavity die:
 - 0.14 to 0.75 mm².
 - 1.0 to 1.5 mm².
 - 2.5 mm².
 - 4.6 mm².
 - 6.0 mm².
 - 10.0 mm².
- Weight: 52 g.

821431 Die for pre-insulated terminals



CEI 760

- 3 cavity die:
 - Red cavity: 0.5 to 1 mm²; 20 - 16 AWG.
 - Blue cavity: 1.5 to 2.5 mm²; 16 - 14 AWG.
 - Yellow cavity: 4 to 6 mm²; 4 - 6 AWG.
- Weight: 53 g.

821458 Open core terminal die

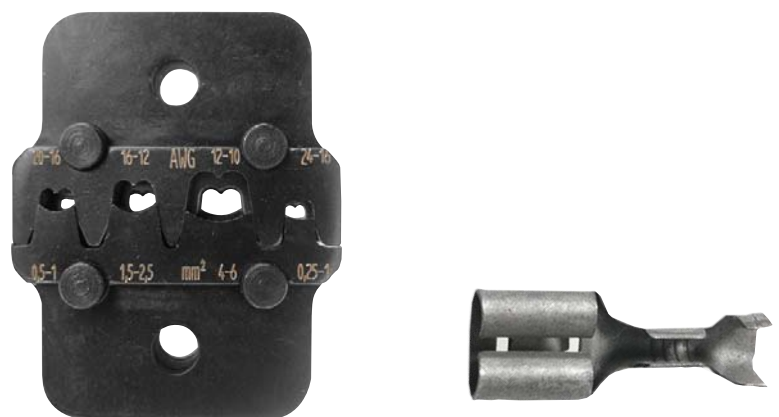

- Parallel crimping profile to crimp the contact and insulator in a single operation.
- Weight: 46 g.

819809 Special electricity set



Complete set including:

- Crimping and stripping pliers 821415.
 - Set of 3 crimping dies for:
 - Cable terminations from 0.14 to 10 mm².
 - Pre-insulated terminals 0.5 to 6 mm².
 - Open core terminals 0.5 to 2.5 mm² and 4 to 6mm².
 - Swingo® strippers 793936.
 - Jivaro® sheath-strippers 985856.
- Weight: 1,350 g.

819391 Standard crimping set



- Crimping and stripping pliers 821415.
 - Set of three crimping dies.
- Weight: 1,128 g.

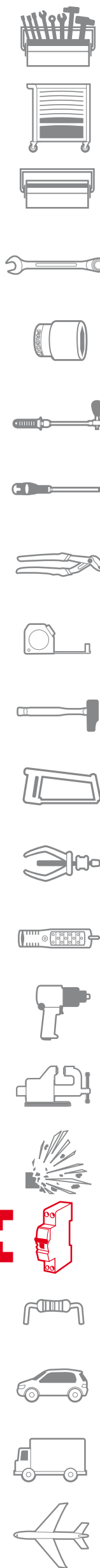

CRIMPING PLIER INSPECTION SERVICE

ISO 9000 quality assurance systems require crimping equipment to be periodically checked for compliance with the standards and recommendations. That is why Facom's laboratory offers this service.

Pliers covered by the inspection service

- Pliers for insulated terminals to CEI 760- 985753, 985894, 673838.
- Pliers for cable terminals to NFC 20130- 985754, 985755, 985756, - 985896, 985897, 985895.

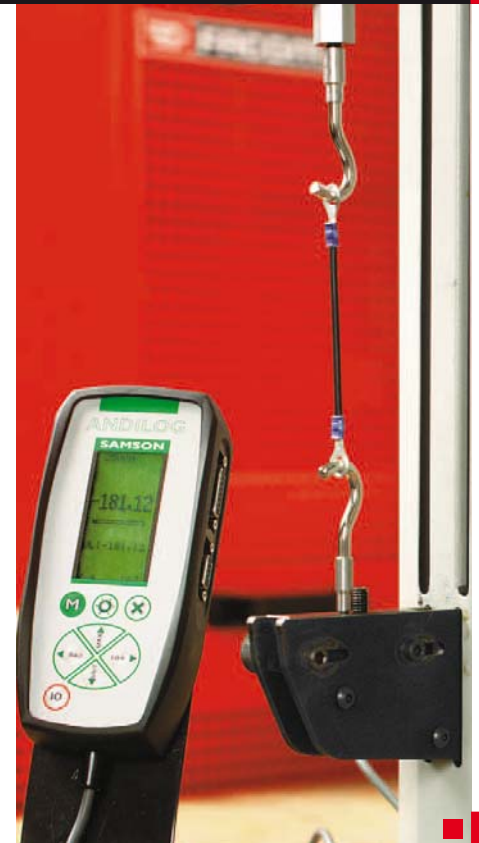

673838

CRIMPING PLIERS FOR INSULATED TERMINALS WITH LOCATOR

A THIRD HAND!

Complies with NFC 63-023

- Automatically positions the terminal to guarantee a secure attachment.
- Stainless steel dies ensuring good wear resistance.
- Reverse crimping for precision and visibility.
- Left/right-hand operation.
- Soft comfortable grips.

Serkan

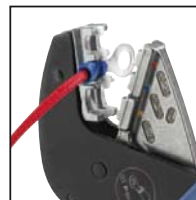

Holds the terminal on the pliers.



Perfectly positions the wire in the terminal.



Holds the terminal and the wire after crimping.



673838 SERKAN® ratchet crimping pliers for insulated terminals with locator



NFC 63-023

- Lower fixed jaw: easy terminal fitting.
 - Double crimping with die marking on the insulator.
 - Stainless steel die with 3 cavities:
 - Red cavity: 0.5 to 1.5 mm².
 - Blue cavity: 1.5 to 2.5 mm².
 - Yellow cavity: 4 to 6 mm².
 - Right/left handed pliers.
- Weight: 490 g.

▣ **985894** Maintenance crimping pliers for pre-insulated terminals



CEI60352-2, CEI 60760

- Double crimping for pre-insulated terminals in compliance with the standard, with holding on the conductor core and the insulator.
- Unlocking accessible at all times.
- Reversed crimping: terminal positioned on the fixed part for more effectiveness and precision.
- Stainless steel die with 3 cavities:
 - Red cavity: 0.5 --> 1.5 mm².
 - Blue cavity: 1.5 --> 2.5 mm².
 - Yellow cavity: 4 --> 6 mm².
- Shape allowing hand setting.
- Soft touch.
- Length: 230 mm.
- Weight: 490 g.

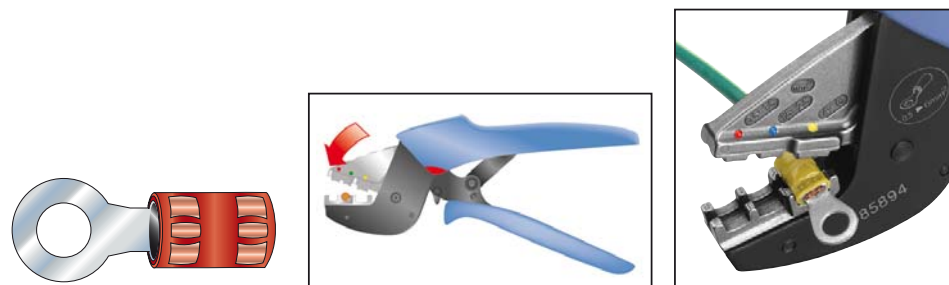

▣ **985753** Production crimping pliers for insulated terminals



CEI 60760

- Extended handle for 2-hand grip.
- Disengaging possible during crimping.
- Double crimping of the terminal.
- 3 cavity die:
 - Red cavity: 0.5 to 1 mm².
 - Blue cavity: 1.5 to 2.5 mm².
 - Yellow cavity: 4 to 6 mm².
- Comfort grip.
- Length: 255 mm.
- Weight: 540 g.

▣ **449B** Standard crimping pliers for insulated terminals

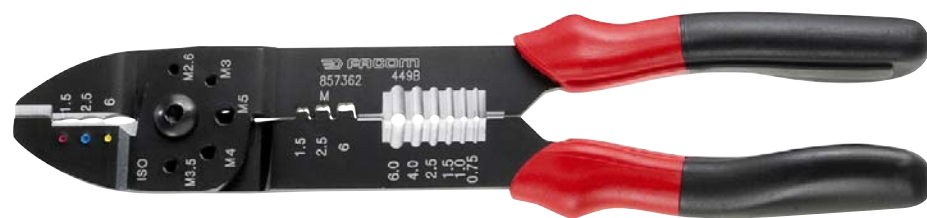

- Crimping pre-insulated terminals: 1.5-2.5-6 mm².
- Crimping bare terminals: 1.5-2.5-6 mm².
- Stripping: 0.75 to 6 mm².
- Built-in wire cutting function.
- Weight: 260 g.

Tubular terminal and sleeve crimping pliers

▣ **985966** Crimping pliers for tubular terminals



NFC 20-130

- Ratchet pliers with possibility of unlocking in case of mishandling.
- Extended handle for 2-hand grip.
- Capacity 4 to 10 mm².
- Comfort grip.
- Length: 255 mm.
- Weight: 500 g.

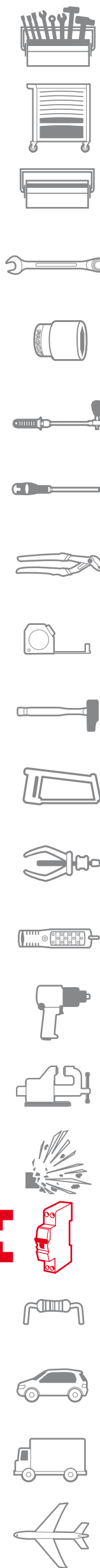
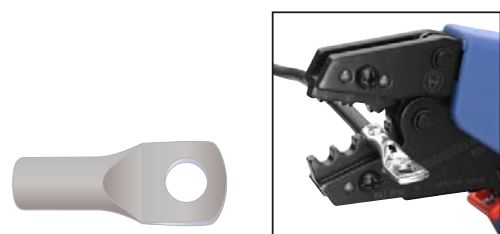

Crimping pliers

986095 Crimping pliers for tubular terminals with rotating dies



NFC 20-130

- Rotating dies indexable in 6 positions: 6 - 10 - 16 - 25 - 35 - 50 mm².
- The pliers can be disengaged during crimping.
- Capacity 6 to 50 mm².
- Length: 390 mm.
- Weight: 1.185 g.

985913 Hydraulic trigger crimping pliers for tubular terminals and sleeves



NFC 20-130

- 35 kN.
- Travel adjustable from 5 to 8 mm by rotation of the notched bush reducing the number of pump strokes for smaller sections.
- Rotating head 360°.
- Automatic trigger with audible "click" upon crimping.
- Piston return by discharge lever.
- Supplied in box.
- Weight: 2.130 g.

Crimping dies

Hexagonal crimping dies

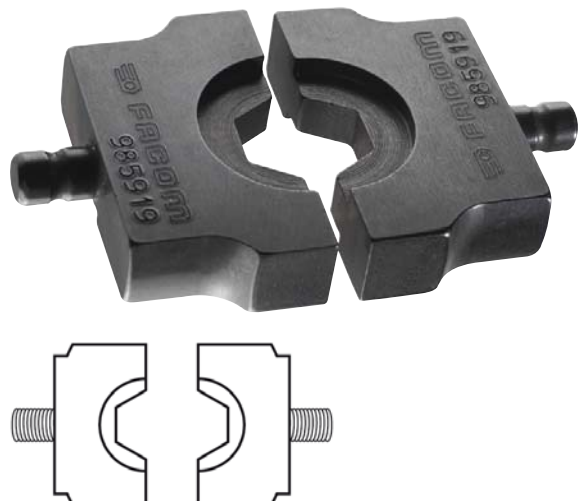

NFC 20-130

- For crimping pliers 985913.
- For tubular terminals and sleeves.

Section [mm ²]	
6	985914
10	985915
16	985916
25	985917
35	985918
50	985919
70	985920
95	985921
120	985922
150	985923

Open core connector crimping pliers

985757 Open core connector crimping pliers



DIN 46249

- Die with 3 cavities for open core terminals with 1.5; 2.5 and 6 mm² section.
- Capacity 1.5 to 6 mm².
- Length: 195 mm.
- Weight: 250 g.

Wire end crimping pliers

985895 Wire end crimping pliers

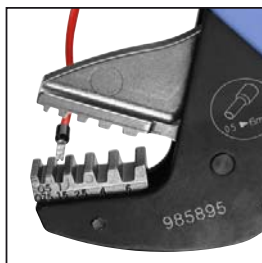
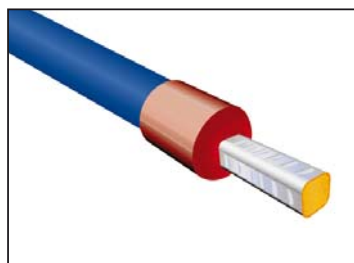

NFC 63-023

- Stainless steel 5-cavity dies:
 - 0.5 to 0.75 mm².
 - 1 to 1.5 mm².
 - 2.5 mm².
 - 4 mm².
 - 6 mm².
- Unlocking accessible at all times.
- Reversed crimping: terminal positioned on the fixed part for more effectiveness and precision.
- Capacity 0.5 to 6 mm².
- Shape allowing hand setting.
- Soft touch.
- Length: 230 mm.
- Weight: 490 g.

985898 Auto-adjustable wire end crimping pliers

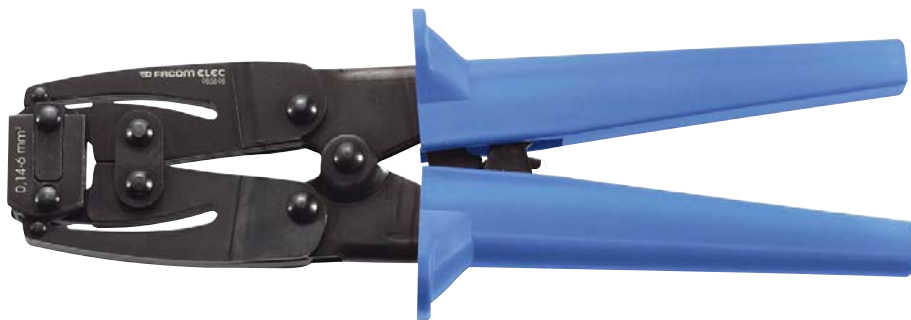

NFC 63-023

- Allows to use the same cavity to crimp terminations from 0.14 to 6 mm² with or without insulation.
- With ratchet system guaranteeing proper crimping.
- Easy unlocking in case of mishandling.
- Comfort grip.
- Length: 210 mm.
- Weight: 500 g.

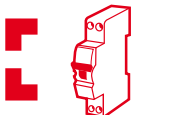
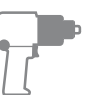
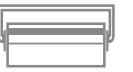

Crimping pliers

985899 Standard wire end crimping pliers



- Capacity: 0.5 to 2.5 mm².
- End nipper.
- Length: 140 mm.
- Weight: 115 g

Production wire end crimping pliers



- Easy unlocking in case of mishandling.
- Comfort grip.

➤	L [mm]	Capacity Cubic [mm ³]	Pattern	ΔΔ [g]
985755	195	0,5 -> 6,0 mm ²	5	250
985756	195	4,0 -> 10,0 mm ²	3	500
985896	255	10,0 -> 25,0 mm ²	3	500
985897	255	35,0 -> 50,0 mm ²	2	500

Transmission connectors crimping pliers

985902 Phone connector crimping pliers



- Pliers supplied in a case with the 986022 die for RJ45 connectors.
- Length: 205 mm.
- Weight: 450 g

Crimping dies for phone connectors

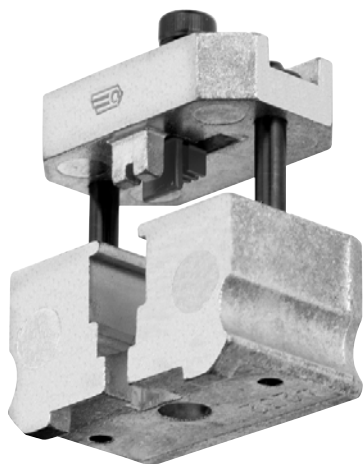

- For crimping pliers 985902.

➤	d [mm]	ΔΔ [g]
986014	RJ11	50
986015	RJ9 - RJ22	50
986022	RJ45	50
986026	MMJ	50

▣ 985758 Coax connector crimping pliers



- For BNC connector RG58 - RG59 - RG62.
- Crimping die for coax connectors:
 - 5.36 - 5.46 for RG58.
 - 6.43 - 6.53 for RG59, RG 62.
 - 1.64 - 1.74 for the core.
- Safety rack guaranteeing complete crimping.
- Length: 195 mm.
- Weight: 250 g

Terminal sets

▣ 449.Z3A "general electricity" set



- Including:
- Crimping pliers 449B.
 - Selection of 20 models of pre-insulated terminals and accessories:
 - Eyelets.
 - Fork terminals.
 - Sleeves.
 - Male and female terminals.
- Weight: 1.850 g

▣ 855367 "industrial electricity" set



- Including:
- Multifunction crimping pliers 821415.
 - 2 dies for pre-insulated terminals 0.5 to 6 mm².
 - 2 dies for open core terminals 0.5 to 6 mm².
 - 2 dies for cable terminations from 0.25 to 10 mm².
 - Selection of 20 models of pre-insulated terminals and accessories:
 - Eyelets.
 - Fork terminals.
 - Sleeves.
 - Male and female terminals.
- Weight: 1.950 g

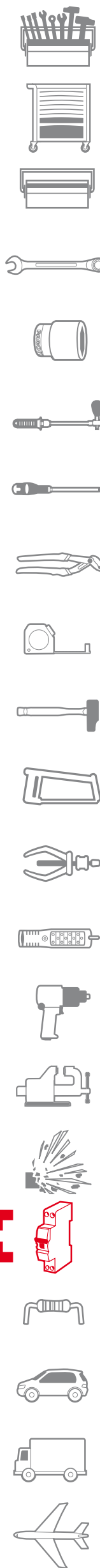

Sleeving pliers

▣ Sleeving pliers

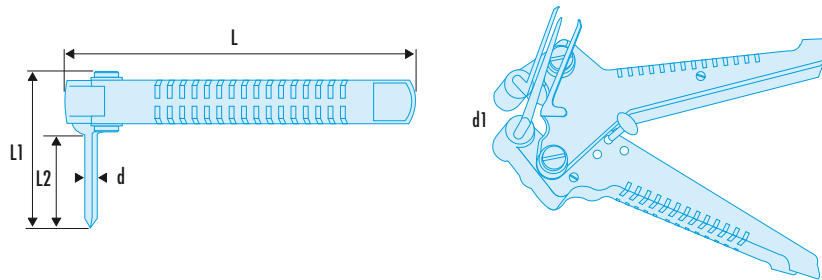

➤	d [mm]	d1 [mm]	L [mm]	L1 [mm]	L2 [mm]	Wire Ø [mm]	ΔΔ [g]
985763	3,5	12- 16 - 24	140	52	23	1,25 -> 4,50	165
985764	4,5	13 - 18 - 24	140	56	30	1,75 -> 9,00	165
985765	5,0	14 - 18 - 25	140	66	40	3 -> 15	165
640171	10,0	19,5 - 22,5 - 30,0	150	82	56	10 -> 28	149

Plastic cable-tie pliers

▣ Plastic cable-tie pliers

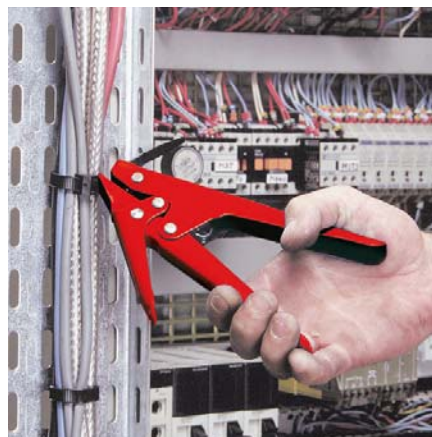
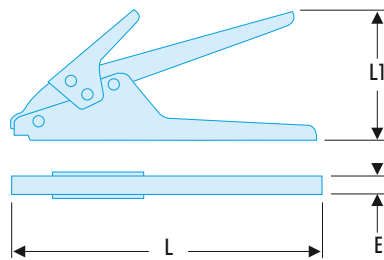

- For all cable-ties 2.4 to 9 mm wide.
 - Sturdy and easy to use, very good demultiplication.
 - Long travel for a fast approach.
 - Manual cable-tie tail cutting.
- Weight: 310 g

➤	E [mm]	L [mm]	L1 [mm]	ΔΔ [g]
455B	17	190	100	310

▣ **986075** Automatic plastic cable-tie pliers



- For cable-ties 2.2 to 4.8 mm wide and 1.6 mm thick.
 - Adjustable tightening strength.
 - Automatic cable-tie tail cutting.
- Weight: 290 g

Glue gun

■ E.900A Glue gun



- To glue plastic, synthetic foam, fabric, wood and stratified in the fields of construction, furniture, in assembly shops of electrical and electronic assemblies, in the garage.
- Voltage: 110-240 Volts (without automatic switch).
- Maximum power: 45 W.
- Fusion temperature: 206 °C.
- Preheating time: 7 to 10 min.
- Supplied in a box with three sticks of all-purpose glue.
- Dimensions: 260 x 210 x 60 mm.
- Weight: 620 g

- E.905J50: "refractory" glue:
 - Set of 50 sticks: diam. 11.3 mm, length 90 mm.
- E.906J100: "all-purpose" glue:
 - Set of 100 sticks: diam. 11.3 mm, length 200 mm.

Cabinet keys

■ 838305 Multi-cavity cross brace

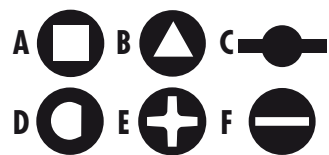
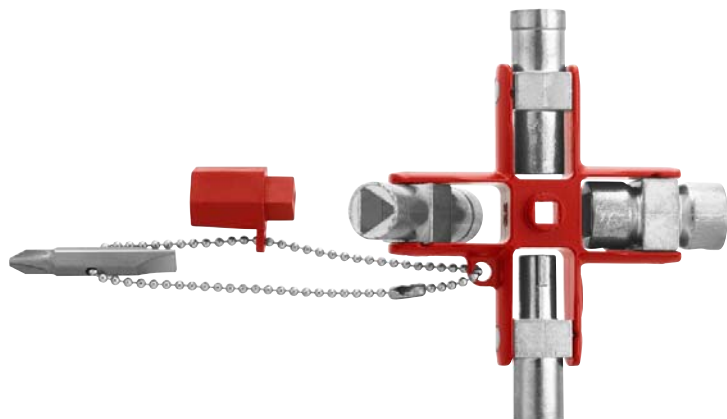

- Good access, opens most doors and elements, whether in industry or in construction.
- 9 cavities in a light, compact and very handy tool.
 - 4 square cavities: 5, 6, 7-8, 9-10 mm (A).
 - 3 triangular cavities: 7, 8-9, 10-11 mm (B).
 - 1 slotted cylindrical cavity: 3-5 mm (C).
 - 1 round cavity with flat: 6 mm (D).
- 1 bit with 2 screwing cavities Phillips® PH 2 (E) and slotted head 7 mm (F), linked with the wrench by a removable chain with bit adapter.
- Weight: 210 g

■ 985548 Four-way wrench for cabinets

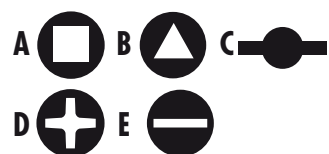
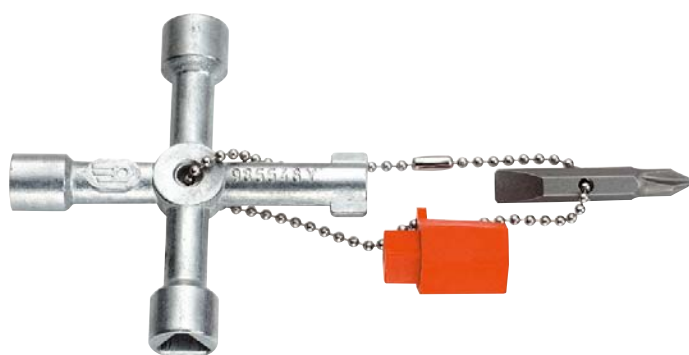

- Toll supplied with 6-point adaptor for 1/4" - 6.35 mm drive bits.
- 4 cavities:
 - 2 square cavities: 6, 8 mm (A).
 - 1 triangular cavity: 9 mm (B).
 - 1 slotted cylindrical cavity: 5-14 mm (C).
- 1 bit with 2 screwing cavities Phillips® PH 2 (D) and slotted head 7 mm (E).
- Weight: 75 g

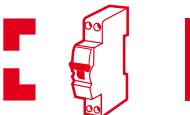
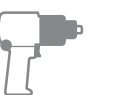
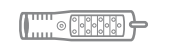

Nylon rods

FISH TAPES

3 TYPES OF WIRE PULLER



Nylon

- Relatively uncongested cable ducts with average bends, Distance < 20 m.
- Very high tensile strength.



Glass fibre

- Congested cable ducts with multiple bends, 20 m < distance < 40 m.
- Material has excellent dynamic.
- Maintains its efficiency after passing an obstacle.



Nylon-coated steel

- Long runs in highways 30 m < distance < 50 m.
- Excellent dynamic properties.
- Pushing force for tubes Ø 24 mm and over.



Nylon rods



- Supplied with:
 - 1 flexible guiding head.
 - 1 pulling eye.
- Breakage load: 120 kN.
- Diameter: 4 mm.

➤	L [m]	d [mm]
629731	10	4
629757	20	4

Nylon rod 20 m + needle holder casing

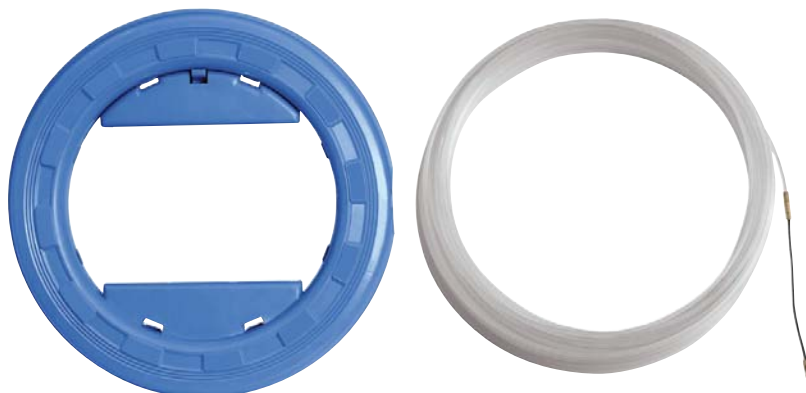

- Supplied with:
 - 1 flexible guiding head.
 - 1 pulling eye.
- Breakage load: 120 kN.
- For poorly clogged and medium curved ducts.
- For distance below 20 m.

➤	d [mm]	L [m]
669273	4	20

629765 Needle holder casing

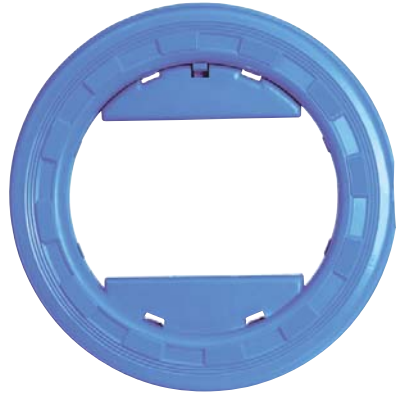

- For a rod 10 to 40 m long.
- Housing for accessories and repair kit.

Glass fibre rods

629853 Glass fibre rods

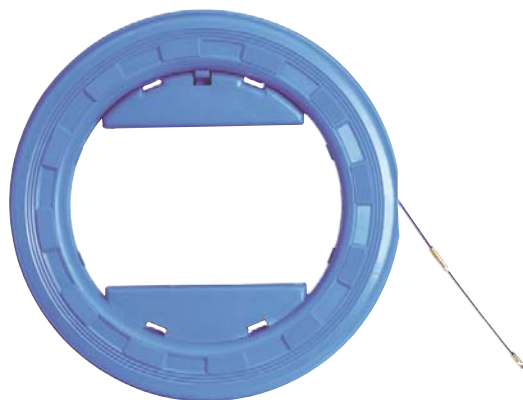

- Supplied in a needle holder casing with:
 - 1 flexible guiding head.
 - 1 pulling eye.
 - 1 repair set.
- Breakage load: 120 kN.

	d [mm]	L [m]
629853	3	30
629861	3	40

Accessories

629888 Glass fibre rod repair kit



- Including:
- 2 bits.
 - 1 seal.
 - 1 specific glue.

629773 Fish tape pulling pliers

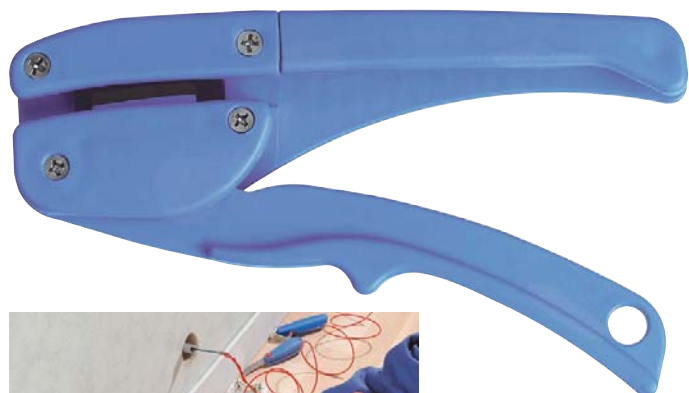

- Easy handling of rods without damaging them and avoiding hand injuries.
- Shock-proof material.

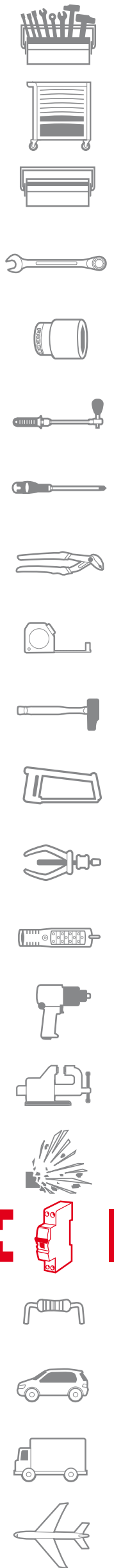

▣ 629984 Lubricant



- To be sprayed on the cable before pulling it.
 - Facilitates pulling.
 - Supplied in 1-litre bottle.
- Weight: 1.100 kg

Consumables for nylon and glass fibre rods

▣ 629781 Flexible guiding head for nylon and glass fiber rods



- Female part: M4 threading.

▣ 629790 Pulling eye

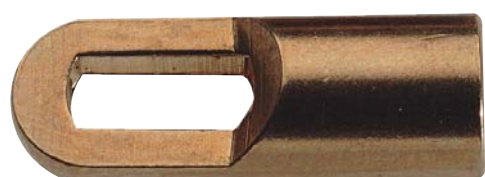

- Female threading.
- Breakage load: 120 kN.

▣ 629896 Nylon steel rod

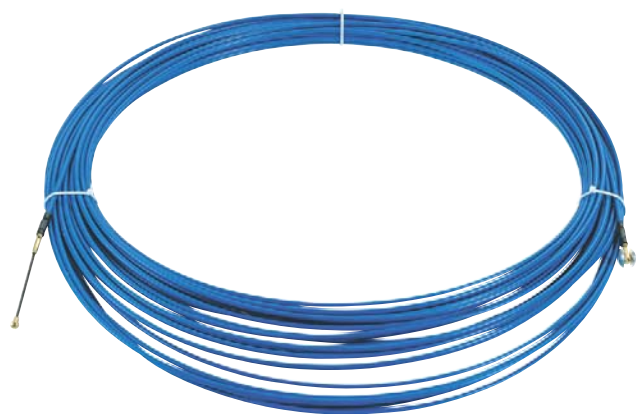

- Ideal for long ducts.
- High traction power.
- Breakage load: 200 kN.
- Rod length: 50 m.
- Diameter 6 mm.
- Supplied with:
 - 1 flexible guiding head.
 - 1 slide wheel with swage.
 - 1 snap hook.

Accessories for nylon steel rods

▣ 629909 Tropic-proof steel reel

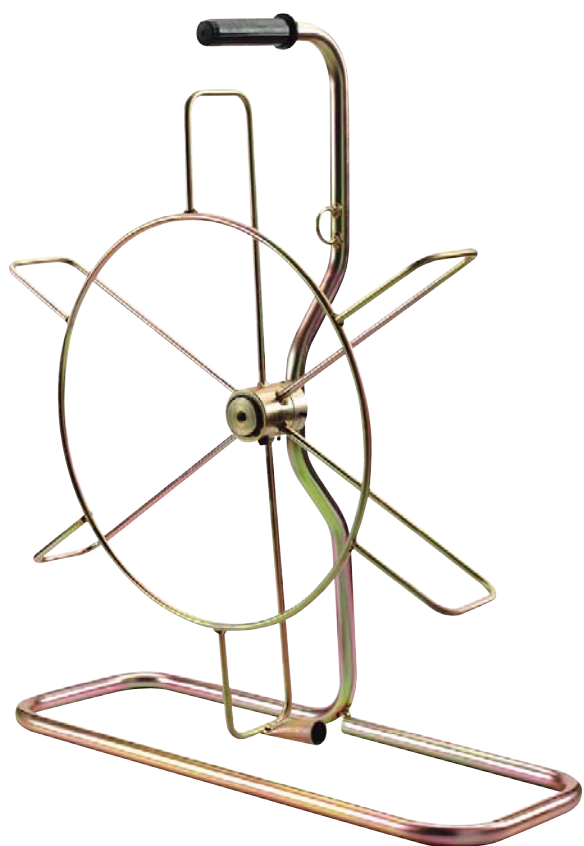

- Fast guiding and winding of the the rod.
 - Ideal for long rods.
 - Storage of nylon steel rods up to 150 m.
 - Axis on ball bearing.
 - Withstands heat and humidity.
- Weight: 5.900 kg

▣ 629984 Lubricant



- To be sprayed on the cable before pulling it.
 - Facilitates pulling.
 - Supplied in 1-litre bottle.
- Weight: 1.100 kg

▣ 629968 Snap hook



- Breakage load: 400 kN.

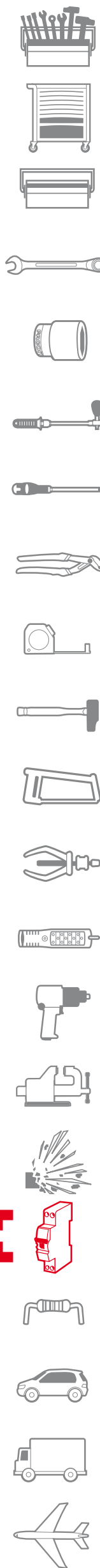

HOLE PUNCHES FOR ISO HOLE SIZES

HOLE PUNCH FOR ISO HOLE SIZES

- 3 section ISO splitting punch.
- Spread: ISO 12 to ISO 63.
- Blanks split into three, thus preventing the actuating screw from jamming.
- Cutting-point geometry ensures longer life.
- Available with or without a thrust-bearing screw.

1 - For ordinary steel ST37

- Max. sheet thickness: 2 mm.
- Pilot hole: - Screw \varnothing + min 0.2 mm.



2 - For stainless steel

- Max stainless steel plate thickness:
 - 2 mm with screw \varnothing 11.1 mm.
 - 3 mm with screw \varnothing 19 mm.
- Pilot hole:
 - Screw \varnothing + min 0.2 mm.
- High alloy cutting edges for increased durability.



HOLE PUNCH FOR PG HOLE SIZES

- Spread: PG7 to PG48.

3 - For ordinary steel ST37

- 3-point punch.
- Circular blank automatically drops out after punching with a couple more turns of the wrench.
- Max. thickness:
 - 2 mm with screw \varnothing 9.5 mm.
 - 3 mm with screw \varnothing 19 mm.
- Pilot hole: - Screw \varnothing + min 0.2 mm.



4 - For stainless steel

- Max stainless steel plate thickness:
 - 2 mm with screw \varnothing 9.5 mm
 - 3 mm with screw \varnothing 19 mm
- Pilot hole: Screw \varnothing + min 0.2 mm.
- High alloy cutting edges for increased durability.



FACOM HOLE PUNCHES CAN BE OPERATED IN THE FOLLOWING WAYS:



With a wrench

For hole punches fitted with a thrust-bearing screw.



With a

hydraulic driver

DIMENSIONS (mm):

ISO12	ISO16	ISO20	ISO25	ISO32	ISO40	ISO50	ISO63		
12.5	16.5	20.5	25.5	32.5	40.5	50.5	63.5		
PG7	PG9	PG11	PG13	PG16	PG21	PG29	PG36	PG42	PG78
12.7	15.2	18.6	20.4	22.5	28.3	37	47	54	60

ISO EN 50262 REQUIREMENTS

- This international standard specifies the electrical functions and performance of cable entries.
- It stipulates that only ISO metric threads are to be used for cable glands since September '99.
- The use of PG threads will still be allowed for the maintenance of existing equipment despite no longer being covered by any national or international standard.

Remember to apply lubricant to the screw/pin for optimum operation of the punch.

CUSTOM SIZE KNOCKOUT PUNCH

Please consult us for your specific punch size or shape requirements.

■ Punches for PG size holes with actuating screw



- For circular cut out in metal sheet and plastic.
- Operated with a wrench or ratchet/socket set.
- Fast, clean and burr-free cut out.
- For all diameters PG 7 to PG 48.
- Parts greased for better use.
- TIP: the round cut falls much easier when applying 2 or 3 additional turns with the tightening wrench after cutting out.
- Supplied with punc, die, and ball stop screw.

Table caption:

- d = PG diameter/mm.
- d1 = drilling diameter/mm.
- Screw = dimension on flat (mm)/ operating screw.
- E = max/thickness steel/soft.

⇒	d [mm]	d1 [mm]	E [mm]	PG	Screw Size [mm]
985968	12,7	11	2	7	17
985969	15,2	11	2	9	17
985972	18,6	11	2	11	17
985974	20,4	11	2	13	17
985978	22,5	11	2	16	17
985984	28,3	11	3	21	17
985995	37,0	11	3	29	27

■ Punches and dies for PG size holes without screw



- For circular cut out in metal sheet and plastic.
- Control with Hydraulic gun 643743 (one position) or 986108 (2 positions) or hydraulic pump.
- Fast, clean and burr-free cut out.
- For all diameters PG 7 to PG 48.
- Parts greased for better use.
- TIP: the round cut falls much easier when applying 2 or 3 additional pump strokes once cutting complete.
- Supplied with punch, die.

Table caption:

- d = PG diameter/mm.
- d1 = drilling diameter/mm.
- Screw = dimension on flat (mm)/ operating screw.
- E = max/thickness steel/soft.

⇒	d [mm]	d1 [mm]	E [mm]	PG	Actuating Pin
985734	12,7	11	2	7	986064
985801	15,2	11	2	9	986064
985817	18,6	11	2	11	986064
985818	20,4	11	2	13	986064
985820	22,5	11	2	16	986064
985824	28,3	22	3	21	986065
985826	37,0	22	3	29	986065
985829	47,0	22	3	36	986065
985836	54,0	22	3	42	986065
985933	60,0	22	3	48	986065

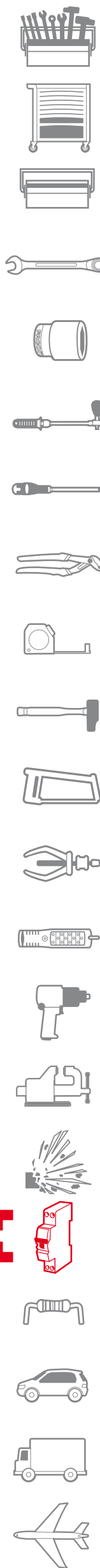

Standard circular punches for ISO size holes

▣ Punches for ISO size holes with actuating screw



- For circular cut out in metal sheet and plastic.
- Operated with a wrench or ratchet/socket set.
- Fast, clean and burr-free cut out.
- For all ISO diameters from M12 to M63.
- Parts greased for better use.
- PRODUCT PLUS: the round is slit into three parts and falls automatically at the end of the cutting operation.
- Supplied with punch, die, and ball stop screw.

Table caption:

- d = ISO diameter/mm.
- d1 = drilling diameter/mm.
- Screw = dimension on flat (mm)/ operating screw.
- E = max/thickness steel/soft.

➤	d [mm]	d1 [mm]	E [mm]	ISO	Screw Size [mm]
693716	12,5	11	2	M12	17
697590	16,2	11	2	M16	17
693695	20,4	11	2	M20	17
697602	25,4	11	2	M25	17
697611	32,5	22	2	M32	27
697645	40,5	22	2	M40	27
697637	50,5	22	2	M50	27
697653	63,5	22	2	M63	27

▣ Punches for ISO size holes without actuating screw



- For circular cut out in metal sheet and plastic.
- Control with hydraulic gun 643743 (one position) or 986108 (2 positions) or hydraulic pump.
- Fast, clean and burr-free cut out.
- For all ISO diameters from M12 to M63.
- Parts greased for better use.
- PRODUCT PLUS: the round is slit into three parts and falls automatically at the end of the cutting operation.
- Supplied with punch, die.

Table caption:

- d = ISO diameter/mm.
- d1 = drilling diameter/mm.
- Screw = dimension on flat (mm)/ operating screw.
- E = max/thickness steel/soft.

➤	d [mm]	d1 [mm]	E [mm]	ISO	Actuating Pin
693708	12,5	11	2	M12	657539
664499	16,2	11	2	M16	986064
693687	20,4	11	2	M20	986064
664510	25,4	11	2	M25	986064
664536	32,5	22	2	M32	986064
664501	40,5	22	2	M40	986065
664528	50,5	22	2	M50	986065
664544	63,5	22	2	M63	986065

Punches - ISO Plus dies for stainless steel plate



- For circular cut out in metal sheet and plastic.
- Control with hydraulic gun 643743 (one position) or 986108 (2 positions) or hydraulic pump.
- Fast, clean and burr-free cut out.
- For all ISO diameters from M12 to M63.
- Parts greased for better use.
- PRODUCT PLUS: the round is slit into three parts and falls automatically at the end of the cutting operation.
- Supplied with punch, die.

Table caption:

- d = ISO diameter/mm.
- d1 = drilling diameter/mm.
- Screw = dimension on flat (mm)/ operating screw.
- E = max/thickness steel/soft.

	d [mm]	d1 [mm]	E [mm]	ISO PLUS	Actuating Pin
697469	16,2	11,5	2	M16	657547
697493	20,4	11,5	2	M20	657547
697506	25,4	11,5	2	M25	657547
697514	32,5	22	2	M32	986065
697522	40,5	22	2	M40	986065
697549	50,5	22	2	M50	986065
697531	63,5	22	2	M63	986065



Hydraulic hole punch equipment

986108

HYDRAULIC PUNCH DRIVER

ROTATING HEAD HYDRAULIC DRIVER!

- Two operating positions.
- Fast cutting, short piston stroke.
- Demultiplication of effort for fast, easy working.

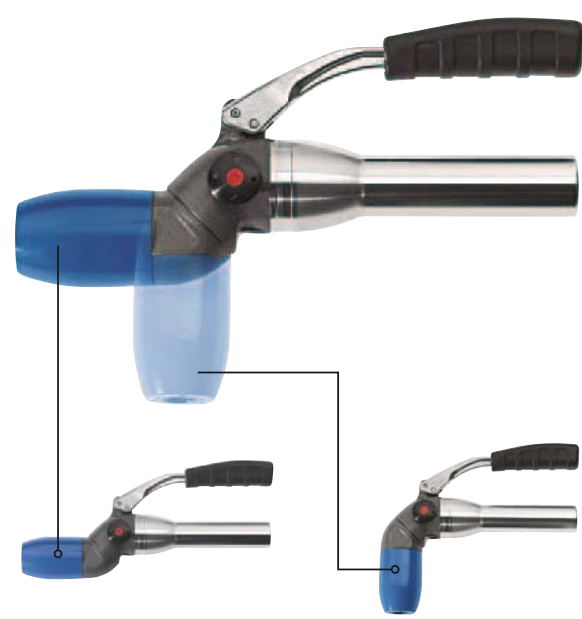

986052 Dual-position hand-operated hydraulic driver and accessories



- Hydraulic tool to cut steel panel diameter 12.5 to 63 mm.
 - The 180° swivel head allows for 2 work positions:
 - Straight for direct work on the cabinet.
 - Right angle to work on workbench.
 - Jack power 7 kN.
 - Pressure 700 bar.
 - Piston travel 20 mm.
 - Pressure limiter.
 - Set supplied in a plastic box with:
 - Manual 2-position hydraulic device (986108).
 - Spacer bush no.1 (986110).
 - Spacer bush no.2 (986111).
 - Control axis 9.5 mm (986064).
 - Control axis 19 mm (5986065).
 - Control axis 6 mm (657539).
 - Drill bit 11 mm (986051).
- Weight: 2.450 kg

986108 Dual-position hand-operated hydraulic driver without accessories



- The 180° swivel head allows for 2 work positions:
 - Straight for direct work on the cabinet.
 - Right angle to work on workbench.
 - Piston travel 20 mm.
 - Jack power 7 kN.
 - Pressure 700 bar.
 - Pressure limiter.
 - Device supplied without accessories:
 - Packaging: cardboard box.
- Weight: 2.300 kg

653255 Single-position hand-operated hydraulic driver and accessories



- Hydraulic tool to cut steel panel diameter 12.5 to 63 mm.
- Piston travel 20 mm.
- Jack power 7 kN.
- Set supplied in a plastic box with:
 - Manual single position hydraulic device (643743).
 - Spacer bush no.1 (986110).
 - Spacer bush no.2 (986111).
 - Drive axis 9.5 mm (986064).
 - Drive axis 19 mm (986065).
 - Drive axis 6 mm (657539).
 - Drill bit 11 mm (986051).
- Weight: 2.350 kg

643743 Single-position hand-operated hydraulic driver without accessories



- Piston travel 20 mm.
- Jack power 7 kN.
- Device supplied without accessories:
- Packaging: cardboard box.
- Weight: 2.200 kg

Accessories

ISO staged drill bit



- For cylindrical high accuracy drilling in all diameters.
- Does not require a tapping hole.
- Cylindrical shank with 3 flats for proper drive, avoiding micro locking.
- Marking of different diameters.
- 678014: Special PG cable gland.
- Panel drilling capacity up to 4 mm thickness.
- Shank diameter 10 mm.
- Min - max diameter: 6.5 - 8.5 - 10.5 - 12.5 - 16.5 - 20.5 - 25.5 - 29 - 32.5 - 36.5 - 40.5 mm.
- Length 96 mm.

678006	d1 [mm]	L [mm]	ΔΔ [g]
678006	10	96	310

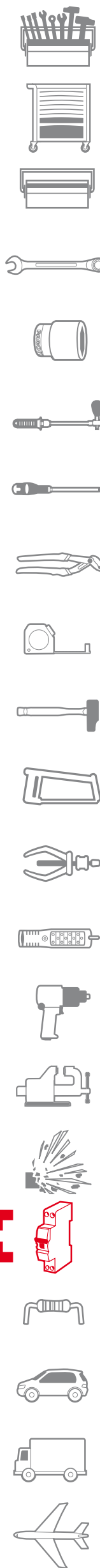

Hole punches

PG staged drill bit



- For cylindrical high accuracy drilling in all diameters.
- Does not require a tapping hole.
- Cylindrical shank with 3 flats for proper drive, avoiding micro locking.
- Marking of different diameters.
- 678014: Special PG cable gland.
- Panel drilling capacity up to 4 mm thickness.
- Shank diameter 10 mm.
- Min - max diameter: 6 - 9 - 12.5 - 15.2 - 18.6 - 20.4 - 22.5 - 26 - 28.3 - 30.5 - 34 - 37 mm.
- Length 100 mm.

➤	d1 [mm]	L [mm]	ΔΔ [g]
678014	10	100	300

986051 Drill bit diameter 11 mm



- Drill bit diameter 11 mm for tapping hole.

986107 Lubricating paste



- To lubricate the screws and drive axes.
- Weight: 1.470 kg

Hole punch sets

985510 Single-position hydraulic driver and PG size hole punch set



- Set including:
 - 1 manual single position hydraulic device.
 - 2 drive axes 9.5 mm and 19 mm.
 - 2 spacers no.1 and no.2.
 - 1 drill bit diameter 11 mm.
 - 1 series of 10 circular-shaped hole punches diameter 12.7 to 60 mm: PG 7, 9, 11, 13, 16, 21, 29, 36, 42, 48.
 - 1 pot of lubricating paste.
 - 1 storage case.
- Weight: 7.100 kg

587110 Dual-position hydraulic driver and PG size hole punch set



- Set including:
 - 1 manual 2-position hydraulic device.
 - 2 drive axes 9.5 mm and 19 mm.
 - 2 spacers no.1 and no.2.
 - 1 drill bit diameter 11 mm.
 - 1 series of 10 circular-shaped hole punches diameter 12.7 to 60 mm: PG 7, 9, 11, 13, 16, 21, 29, 36, 42, 48.
 - 1 pot of lubricating paste.
 - 1 storage case.
- Weight: 7.460 kg

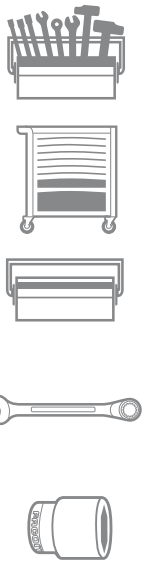

658689 Dual-position hydraulic driver and ISO size hole punch set



- Set including:
 - 1 2-position hydraulic device.
 - 3 drive axes 6 - 9.5 - 19 mm.
 - 2 spacers no.1 and no.2.
 - 1 drill bit diameter 11 mm.
 - 1 series of 8 ISO hole punches from M12 to M50: M 12, 16, 20, 25, 32, 40, 50, 63.
 - 1 pot of lubricating paste.
 - 1 storage case.
- Weight: 7.280 kg



661600 PG size hole punch set



- Hole punch set including:
 - 1 drill bit diameter 11 mm.
 - 1 series of 10 PG hole punches from diam. 12.7 mm to diam. 60 mm: PG 7, 9, 11, 13, 16, 21, 29, 36, 42, 48.
 - 2 drive screws diameter 9.5 and 19 mm.
 - 1 pot of lubricating paste.
 - 1 storage case.
- Weight: 4.900 kg



702571 ISO size hole punch set



- Hole punch set including:
 - 1 drill bit diameter 11 mm.
 - 1 series of 8 ISO hole punches from M12 to M63: M 12, 16, 20, 25, 32, 40, 50, 63.
 - 3 drive screws diameter 6 - 9.5 and 19 mm.
 - 1 pot of lubricating paste.
 - 1 storage case.
- Weight: 6.190 kg

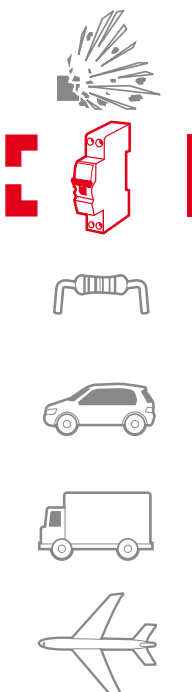

Testers

THE RIGHT TESTER FOR YOUR NEEDS

Simple

- Automatic calibration: easy to use, no risk of error.
- Wide screen providing clear, detailed readings.

Safe

- Meets safety standard requirements.
- Contact-free measurement with the testing tips.

Operational

- Shock-proof coating: resistant to industrial environments.
- Cable storage: saves time.



711A Multimeter



- Maintenance multimeter.
- Ideal for repairing electronic or electromechanical assemblies and for teaching.
- DC / AC voltmeter: 0 to 600 V.
- DC / AC ammeter: 0 to 10 A.
- Ohmmeter: 0 to 40 MO.
- Capacimeter: 0 to 100 μ F.
- Frequency meter: 0 to 100 KHZ.
- Cyclic ratio: 5% to 99 %.
- Diode test.
- Continuity test with buzzer.
- RMS 600 V CAT III.

711A.P500 Clip-on ammeter



- Allows current measurements without contact.
- Compatible with most multimeters.
- Automatic zero point adjustment, perfectly suited to FACOM multimeters 711, 711A, 714 and 714A.
- AC / DC measurement: 0 to 600 A.
- Frequency response: 50 Hz - 60 Hz.
- RMS 600 V CAT III.

712A Clip-on multimeter



- Multimeter for mobile maintenance.
- Current measurement without contact, withstands difficult environments.
- DC / AC voltmeter: 0 to 600 V.
- DC / AC ammeter: 0 to 400 A.
- Ohmmeter: 0 to 40 MO.
- Continuity test with buzzer.
- Diode test.
- Temperature measurement with K thermocouple.
- RMS 600 V CAT III.

VAT DETECTOR: WORK SAFELY

- Check the absence of voltage before starting work around or on a component likely to be live.
- Directive C18-510 imposes the use of a VAT tester, such as the FACOM 701B VAT.
- The FACOM 701B is a must for professionals in construction, industrial maintenance and electricians, ensuring safe and fast work.



701B DAT VAT safety tester



NF EN 601010 - 600 V, IEC 612 43 - 3

- Indispensable for construction and repairing in industrial environments.
- The VAT test allows to check the lack of voltage on a circuit before starting the works.
- Auto test.
- Hazardous voltage detection.
- Phase detector.
- Continuity test with buzzer.
- Differential circuit breaker test: 30 mA.
- Phase rotation indicator.
- 600 V CAT III.

Thermometer

DX.T100 Combination electronic thermometer



- Infrared thermometer with laser aiming.
- Connector for measuring with "K" thermocouples.
- Adjustable emissivity.
- Infrared measurement range: -60°C to +600°C.
- D/S ratio: 11/1.
- Mode: differential, minimum, maximum, average, alarm.

DX.12 Temperature probes



Model	For
DX.12-06	Flexible probe
DX.12-08	Bracelet probe
DX.12-11	Standard needle probe
DX.12-15	Extension
DX.12-17	Surface contact probe
DX.12R	Air probe

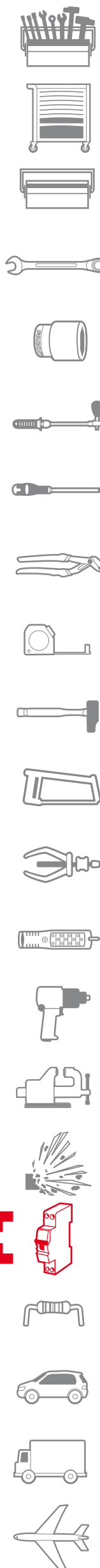

VE series 1,000 Volt insulated diagonal cutting pliers

VE SERIES

1,000 VOLT INSULATED PLIERS



SPATULA-SHAPED PRESSURE AREA, + 20% MORE SLIP-RESISTANT

Guard

- Firm, comfortable grip for pushing or pulling pressure.

Return spring for added safety

- The elastomer spring closes off the metal parts of the tool and prevents the finger slipping towards the uninsulated area.

Insulation tests

Tools to EN 60900 specifications

- 1 Dielectric test
- 2 Penetration test
- 3 Insulation adhesion test
- 4 Impact test
- 5 Non-flammability test

INFORMATION

- Compliance with European standard EN 60900.
- For working on live components up to 1,000 volt AC.
- Each and every tool is tested to 10,000 volt for 10 seconds at the end of the manufacturing cycle.
- Our production site is accredited and certified to produce insulated tools.



Guard



Return spring for added safety

SAFETY

- Prevent damage to insulation from:
 - Heat (-20 to +70°C working temperature)
 - Chemicals
 - Cuts or perforations.
- Check insulation is sound before using a tool.
- Wear insulating gloves and eye protection.



192.VE - 1,000 Volt insulated high-performance diagonal cutters



NF ISO 5749, NF EN 60900, ISO 5749, EN 60900, DIN ISO 5749, DIN EN 60900, ASME B107.500

- For your safety, all pliers are tested individually at 10,000 Volt for 10 seconds, at the end of the manufacturing cycle.
- Cutting edges designed to cleanly cut through all types of wire: piano wire, soft wires, modern materials, etc.
- Minimum cutting force thanks to long lever arm and offset axis.
- High durability thanks to Chrome-Molybdenum-Vanadium steel (hard cutting edges: 61/63 HRC).
- Removable return spring.
- Ergonomic anti-slip grips.
- Finish: polished, varnished.

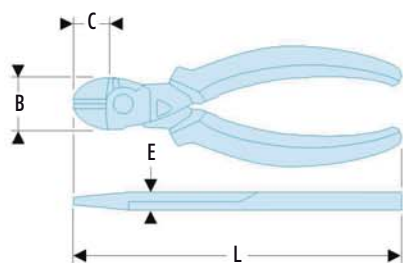

	B [mm]	C [mm]	E [mm]	L [mm]	200 kg/mm ² [Ø mm]	Cu - Ø max [mm]	ΔΔ [g]
192.14VE	21,5	15,5	9,5	145	1,5	0,7 - 3,0	160
192.16VE	24,0	18,0	10,0	160	2,0	0,7 - 4,0	200
192.18VE	26,0	20,0	11,0	180	2,2	0,7 - 4,5	260

1,000 Volt insulated electricians diagonal cutters

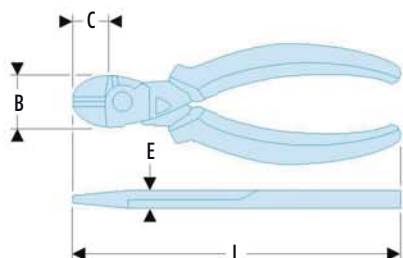

NF ISO 5749, NF EN 60900, ISO 5749, EN 60900, DIN ISO 5749, DIN EN 60900, ASME B107.500

- For your safety, all pliers are tested individually at 10,000 Volt for 10 seconds, at the end of the manufacturing cycle.
- Slim head for confined access (electric cabinets, wiring works, etc.).
- Semi-flush cutting edges to cleanly cut through all types of wire: hard wire, thin copper wires, modern materials, etc.
- Minimum cutting force thanks to long lever arm and offset axis.
- High durability thanks to Chrome-Molybdenum-Vanadium steel (hard cutting edges: 61/63 HRC).
- Removable return spring.
- Ergonomic anti-slip grips.
- Finish: polished, varnished.

	B [mm]	C [mm]	E [mm]	L [mm]	160 kg/mm ² [Ø mm]	Cu - Ø max [mm]	ΔΔ [g]
391.16VE	19	21	9	165	1,6	0,7 - 3,5	190

VE series 1,000 Volt insulated front cutting pliers

1,000 Volt insulated high-performance end cutters

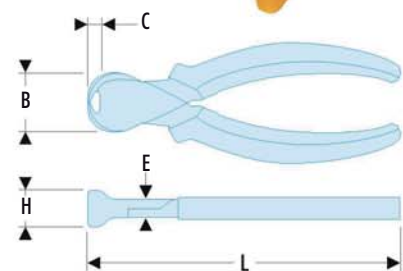

NF ISO 5748, NF EN 60900, ISO 5748, EN 60900, DIN ISO 5748, DIN EN 60900, ASME B107.500

- For your safety, all pliers are tested individually at 10,000 Volt for 10 seconds, at the end of the manufacturing cycle.
- Cutting edges designed to cleanly cut through all types of wire: piano wire, hard and soft wires.
- Minimum cutting force thanks to long lever arm and offset axis.
- High durability thanks to Chrome-Molybdenum-Vanadium steel (hard cutting edges: 61/63 HRC).
- Removable return spring.
- Ergonomic anti-slip grips.
- Finish: polished, varnished.

	B [mm]	C [mm]	E [mm]	L [mm]	200 kg/mm ² [Ø mm]	ΔΔ [g]
190.16VE	28	6,5	11,5	160	1,6	200

VE series 1,000 Volt insulated 1/2 round nose pliers

185-195.VE - 1,000 Volt insulated long half-round nose pliers



185.20VE



195.20VE

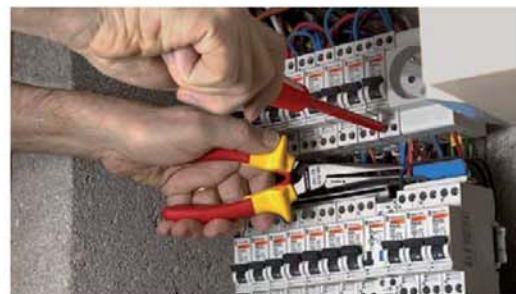
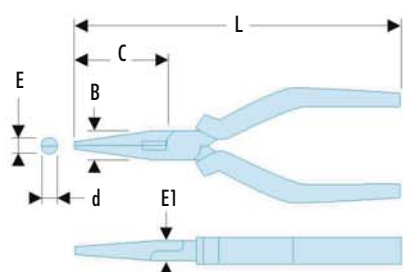

NF ISO 5745, NF EN 60900, ISO 5745, EN 60900, DIN ISO 5745, DIN EN 60900, ASME B107.500

- For your safety, all pliers are tested individually at 10,000 Volt for 10 seconds, at the end of the manufacturing cycle.
- Slim, fine serrated noses.
- Lateral wire cutter for copper and hard steel wire.
- 185.VE: straight nose. Checked by VDE.
- 195.VE: 40° angled nose.
- Removable return spring.
- Ergonomic anti-slip grips.
- Finish: polished, varnished.

	B [mm]	C [mm]	d [mm]	E [mm]	E1 [mm]	L [mm]	160 kg/mm ² [Ø mm]	Cu - Ø max [mm]	ΔΔ [g]
185.20VE	18	75	2,9	3,6	9	200	1,6	0,7 - 3,5	192
195.20VE	18	69	2,9	3,6	9	200	1,6	0,7 - 3,5	192

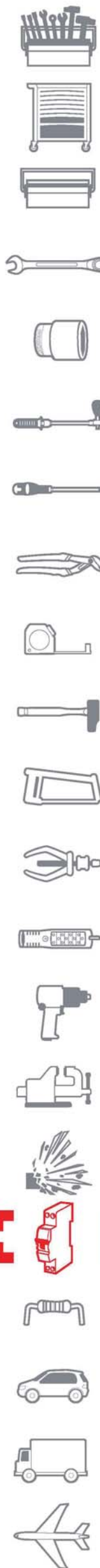

VE series 1,000 Volt insulated pliers

193-195.VE - 1,000 Volt insulated short half-round nose pliers

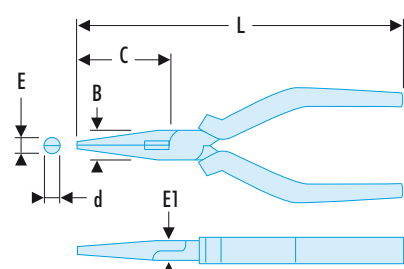

NF ISO 5745, NF EN 60900, ISO 5745, EN 60900, DIN ISO 5745, DIN EN 60900, ASME B107.500

- For your safety, all pliers are tested individually at 10,000 Volt for 10 seconds, at the end of the manufacturing cycle.
- Slim, fine serrated noses.
- Lateral wire cutter for copper and hard steel wire.
- 193.VE: straight nose.
- 195.VE: 40° angled nose.
- Removable return spring.
- Ergonomic anti-slip grips.
- Finish: polished, varnished.

	B [mm]	C [mm]	d [mm]	E [mm]	E1 [mm]	L [mm]	160 kg/mm ² [Ø mm]	Cu - Ø max [mm]	ΔΔ [g]
193.16VE	17	50	2,5	3	9	160	1,6	0,7 - 3,0	177
195.16VE	17	50	2,5	3	9	160	1,6	0,7 - 3,0	177

VE series 1,000 Volt insulated standard multigrip pliers

High capacity 1,000 Volt insulated multigrip pliers

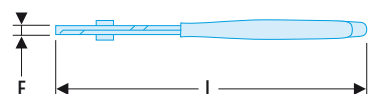
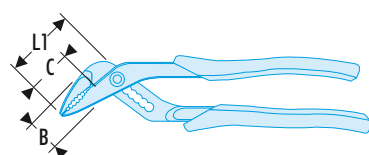

NF ISO 8976, NF EN 60900, ISO 8976, EN 60900, DIN ISO 8976, DIN EN 60900, ASME B107.500

- For your safety, all pliers are tested individually at 10,000 Volt for 10s, at the end of the manufacturing cycle.

	A [mm]	B [mm]	C [mm]	E [mm]	E1 [mm]	L [mm]	L1 [mm]	ΔΔ [g]
180.VE	30	30	35	8	22	250	58	360

VE series 1,000 Volt insulated universal pliers

187.VE - 1,000 Volt insulated combination pliers

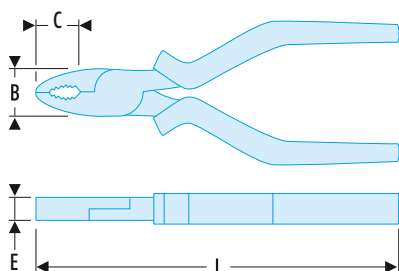

NF ISO 5746, NF EN 60900, ISO 5746, EN 60900, DIN ISO 5746, DIN EN 60900, ASME B107.500

- For your safety, all pliers are tested individually at 10,000 Volt for 10 seconds, at the end of the manufacturing cycle.
- Cutting edges designed to cut through all types of wire: piano wire, soft wires, modern materials, etc.
- Minimum cutting force thanks to long lever arm and offset axis.
- High durability thanks to Chrome-Molybdenum-Vanadium steel (hard cutting edges: 61/63 HRC).
- Removable return spring.
- Ergonomic anti-slip grips.
- Finish: polished, varnished.

	B [mm]	C [mm]	E [mm]	L [mm]	200 kg/mm ² [Ø mm]	ΔΔ [g]
187.16VE	21	34	9,5	165	1,6	195
187.18VE	23	36	10,0	185	1,8	225

VE series 1,000 Volt insulated flat nose pliers

188.VE - 1,000 Volt insulated flat nose pliers

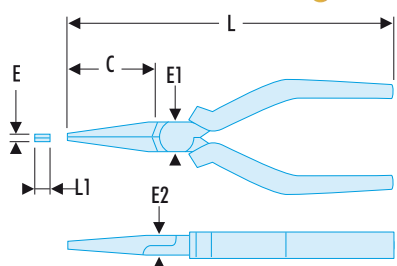

NF ISO 5745, NF EN 60900, ISO 5745, EN 60900, DIN ISO 5745, DIN EN 60900, ASME B107.500

- For your safety, all pliers are tested individually at 10,000 Volt for 10 seconds, at the end of the manufacturing cycle.
- Serrated nose for stronger grip.
- Removable return spring.
- Ergonomic anti-slip grips.
- Finish: polished, varnished.

➤	C [mm]	E [mm]	E1 [mm]	L [mm]	L1 [mm]	ΔΔ [g]
188.16VE	46	4	18	168	6,5	140
188.20VE	75	4	18	200	6,5	200

VE series 1,000 Volt insulated round nose pliers

1,000 Volt insulated round nose pliers

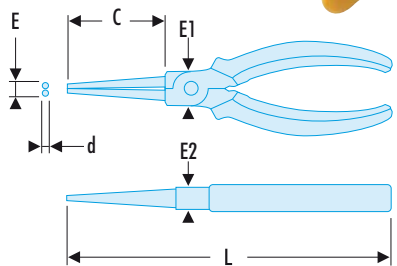

NF ISO 5745, NF EN 60900, ISO 5745, EN 60900, DIN ISO 5745, DIN EN 60900, ASME B107.500

- For your safety, all pliers are tested individually at 10,000 Volt for 10 seconds, at the end of the manufacturing cycle.
- To make loops, angles or rings.
- Nose finely serrated inside for stronger grip.
- Diameter of each nose at the end: 2 mm.
- Removable return spring.
- Ergonomic anti-slip grips.
- Finish: polished, varnished.

➤	C [mm]	d [mm]	E [mm]	E1 [mm]	L [mm]	ΔΔ [g]
189.17VE	41	2	4	18	170	135

VE series 1,000 Volt insulated standard wire strippers

1,000 Volt insulated strippers

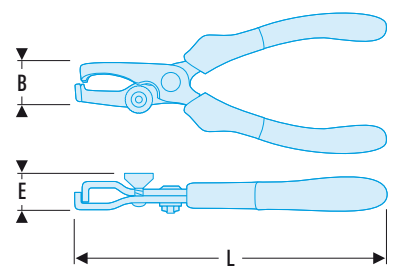

NF EN 60900, EN 60900, DIN EN 60900

- For your safety, all pliers are tested individually at 10,000 Volt for 10 seconds, at the end of the manufacturing cycle.
- For multiple or single strand wires 0.5 --> 6 mm².
- Adjustment screw with lock nut.
- Metal return screw.
- Ergonomic anti-slip grips.
- Finish: polished, varnished.

➤	B [mm]	E [mm]	L [mm]	ΔΔ [g]
194.17VE	17	8,5	170	185

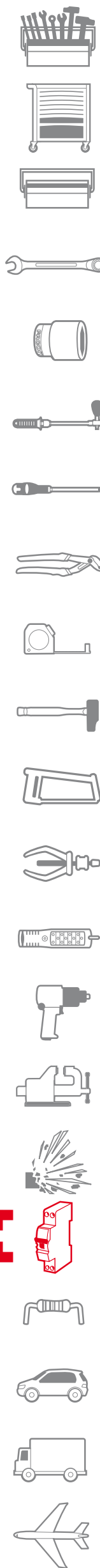

VE series 1,000 Volt insulated screwdriver

Insulated screwdrivers for slotted head screws

▣ A.VE - PROTWIST® 1,000 Volt insulated screwdrivers for slotted-head screws

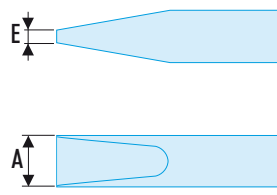
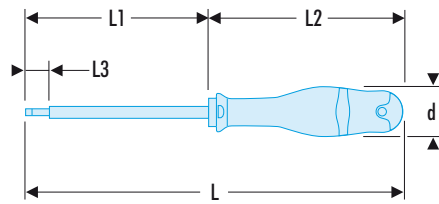

NF ISO 2380-1, NF ISO 2380-2, NF EN 60900, ISO 2380-1, ISO 2380-2, EN 60900, DIN ISO 2380-1, DIN ISO 2380-2, DIN EN 60900, ASME B107.600

- For your safety, each screwdriver is tested individually at 10,000 Volt for 10 seconds, at the end of the manufacturing cycle.
- 1,000 Volt sheathed round blade.
- Milled blade: --> 5.5 mm included.
- Fillet blade: 6.5 --> 12 mm.
- Bi-material grip resists to impacts, abrasion, and chemicals.

➤	A	d	E	L	L1	L2	L3	ΔΔ
	[mm]	[mm]	[mm]	[mm]	[mm]	[mm]	[mm]	[g]
A2X75VE	2,0	19	0,4	170	40	95	18	23
A2,5X50VE	2,5	25	0,4	153	50	103	18	30
A2,5X75VE	2,5	25	0,4	178	75	103	18	32
A3X75VE	3,0	25	0,5	178	75	103	18	38
A3X100VE	3,0	25	0,5	202	100	103	18	39
A3,5X75VE	3,5	25	0,6	179	75	104	18	42
A3,5X100VE	3,5	25	0,6	204	100	104	18	44
A4X100VE	4,0	30	0,8	210	100	110	18	48
A4X150VE	4,0	30	0,8	260	150	110	18	53
A5,5X125VE	5,5	30	1,0	235	125	110	18	88
A5,5X150VE	5,5	30	1,0	260	150	110	18	92
A5,5X200VE	5,5	30	1,0	310	200	110	18	106
A6,5X150VE	6,5	36	1,2	270	150	120	18	120
A6,5X200VE	6,5	36	1,2	320	200	120	18	170
A8X150VE	8,0	40	1,2	275	150	125	18	160
A8X200VE	8,0	40	1,2	325	200	125	18	180
A10X200VE	10,0	40	1,6	325	200	125	18	240
A12X250VE	12,0	40	2,0	375	250	125	18	360

Insulated screwdrivers for Phillips® screws

▣ AP.VE - PROTWIST® 1,000 Volt insulated screwdrivers for Phillips® head screws

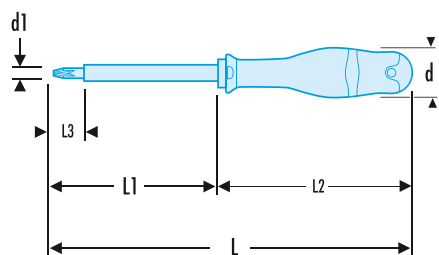

NF ISO 8764-1, NF ISO 8764-2, NF EN 60900, ISO 8764-1, ISO 8764-2, EN 60900, DIN ISO 8764-1, DIN ISO 8764-2, DIN EN 60900, ASME B107.600

- For your safety, each screwdriver is tested individually at 10,000 Volt for 10 seconds, at the end of the manufacturing cycle.
- 1,000 Volt sheathed round blade.
- Bi-material grip resists to impacts, abrasion, and chemicals.

➤	Phillips	d	d1	L	L1	L2	L3	ΔΔ
	[No]	[mm]	[mm]	[mm]	[mm]	[mm]	[mm]	[g]
APOX75VE	PH0	25	3,0	179	75	104	18	46
AP1X100VE	PH1	30	4,5	210	100	110	18	77
AP2X125VE	PH2	36	6,0	245	125	120	18	127
AP3X150VE	PH3	40	8,0	275	150	125	18	195
AP4X200VE	PH4	40	10,0	325	200	125	18	278

Insulated screwdrivers for Pozidriv® screws

AD.VE - PROTWIST® 1,000 Volt insulated screwdrivers for Pozidriv® head screws

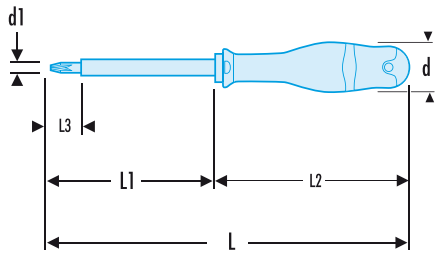
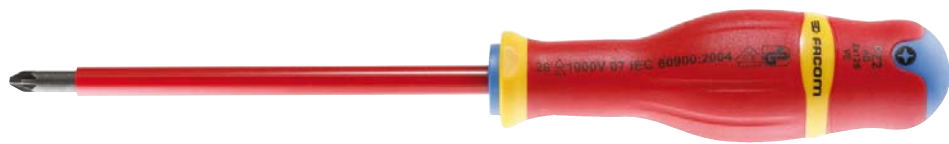

NF ISO 8764-1, NF ISO 8764-2, NF EN 60900, ISO 8764-1, ISO 8764-2, EN 60900, DIN ISO 8764-1, DIN ISO 8764-2, DIN EN 60900, ASME B107.600

- For your safety, each screwdriver is tested individually at 10,000 Volt for 10 seconds, at the end of the manufacturing cycle.
- 1,000 Volt sheathed round blade.
- Bimaterial ergonomic handle, resistance to impact, abrasion and chemical agent.

	Pozidriv [No]	d [mm]	d1 [mm]	L [mm]	L1 [mm]	L2 [mm]	L3 [mm]	ΔΔ [g]
ADOX75VE	PZ0	25	3,0	179	75	104	18	46
AD1X100VE	PZ1	30	4,5	209	100	109	18	77
AD2X125VE	PZ2	36	6,0	245	125	120	18	127
AD3X150VE	PZ3	40	8,0	275	150	125	18	195

Insulated screwdriver sets

A.VE - Sets of PROTWIST® 1,000 Volt insulated screwdrivers



- For your safety, each screwdriver is tested individually at 10,000 Volt for 10 seconds, at the end of the manufacturing cycle.
- Supplied in a box.

	ΔΔ [g]
AD.J5VE	430
AP.J5VE	430
AD.J8VE	650

BORNEO SCREWDRIVER

Borneo®

▶ For our range of Borneo® screw drivers for electrical terminals. See p.408



1000VOLTS
EN 60900

PORTABLE FABRIC BAG

▶ FOR PORTABLE FABRIC BAGS, SEE P. 144 AND 163 IN SECTION 3



FACOM VSE

A COMPREHENSIVE RANGE OF 1,000 VOLT INSULATED TOOLS

For use on live components!

“SAFETY” colour coding

ORANGE: 1,000 V protection.

YELLOW visible: STOP and change tool.



- ❶ **Basic tool:** Facom performance and safety.
- ❷ **Insulation:** Certified and accredited Facom production site. Tested and approved products.
- ❸ **2-colour warning insulation:** ORANGE = 1,000 V protection. YELLOW VISIBLE = STOP and change tool.
- ❹ **Ribbing on flexible insulation:** More secure grip.
- ❺ **Generously-sized guards:** Hand stays clear of the metal.
- ❻ **Hot markings:** Permanent safety data. Traceability.

“CERTIFIED” safety

CORRECT USE OF INSULATED TOOLS

ALWAYS wear insulating gloves and eye protection. Check insulation is sound before using a tool.

- Never use a tool with cracked, cut or damaged insulation in any way.
 - Discard tools if their insulation looks unsafe.
 - Don't alter the insulation.
 - Don't let other people use your insulated tools.
 - Always use the correct tool.
 - Check that the tool bears standard and approval markings.
 - Read safety recommendations and keep the instructions.
- These products come with safety recommendations.
- Beware of electrical hazards.
 - Prevent damage to insulation from :
 - Heat (-20 to 70°C working temperature),
 - Cuts or perforations.,
 - Chemicals. Visually check the insulation before use.
 - Wear insulating gloves and eye protection.
 - 2-colour insulation :
 - Orange = safe.
 - Yellow = STOP.

TOOLS TO EN60900 SPECIFICATIONS

- **Individual production test:** Each and every tool is tested to 10,000V for 10 seconds at the end of the manufacturing cycle.

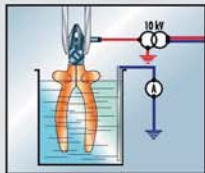

Dielectric test: After 24 hours immersion, the tool is wiped and tested to 10,000 V for 3 minutes between metal and sheath surface. Leakage current should not exceed specified limits.

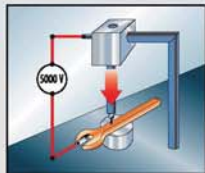

Penetration test: After a penetration test on the most vulnerable part of the tool, followed by heating and cooling, no breakdown or flashover should occur when 5,000 volts is applied for a period of 3 minutes.



Insulation adhesion test: A 50 kg tear test is carried out for 3 minutes at ambient temperature on a tool heated to 70°C for 168 hours. Sheath and guard should remain bonded to the metal.

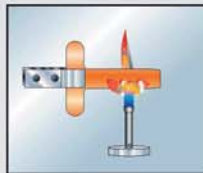

Non-flammability test: After exposure to a flame for 10 seconds, flame spread over the tool should not exceed 120 mm high within the next 20 seconds.

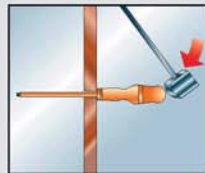

Impact test: A standard force is repeatedly applied to the handle end of a tool cooled to -25°C for 2 hours. The sheathing should not crack.



Multigrip pliers

VSE series 1,000 Volt insulated multigrip pliers

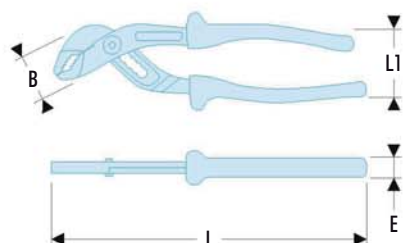

NF ISO 8976, NF EN 60900, ISO 8976, EN 60900, DIN ISO 8976, DIN EN 60900

- Insulation with "safety" colour coding.

Model	B [mm]	E [mm]	L [mm]	L1 [mm]	ΔΔ [g]
180.VSE	40	35	250	85	360

Cutting pliers

FACOM VSE 1,000 VOLTS®



Tools built for electrical safety to European standard EN 60900. For working on live components up to 1,000 Volt AC and 1,500 Volt DC.

SAFETY COLOUR-CODING

- ORANGE:** 1,000 Volt protection
- YELLOW VISIBLE:** STOP and change tool.



192.AVSE - VSE series 1,000 Volt insulated diagonal cutting pliers for hard wire

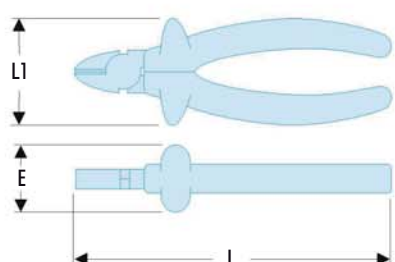

NF ISO 5749, NF EN 60900, ISO 5749, EN 60900, DIN ISO 5749, DIN EN 60900, ASME B107.500

- Tempered cutting edges for hardness above 60 HRc.
- 3 cutting diameters/200 kg/mm²: 1.4 - 1.6 - 1.8 mm.
- Insulation with "safety" colour coding.
- Finish: burnished head.

Model	E [mm]	L [mm]	L1 [mm]	200 kg/mm ² [Ø mm]	ΔΔ [g]
192.14AVSE	30	145	70	1,4	210
192.16AVSE	35	165	75	1,6	270
192.18AVSE	40	185	75	1,8	370

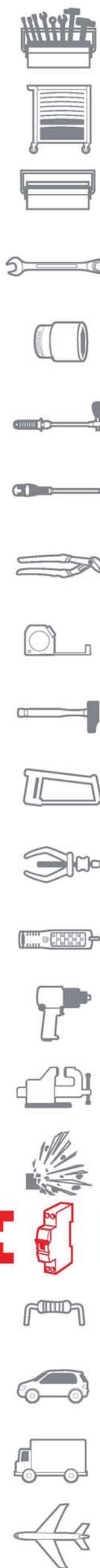

■ VSE series 1,000 Volt insulated diagonal cutting pliers for copper

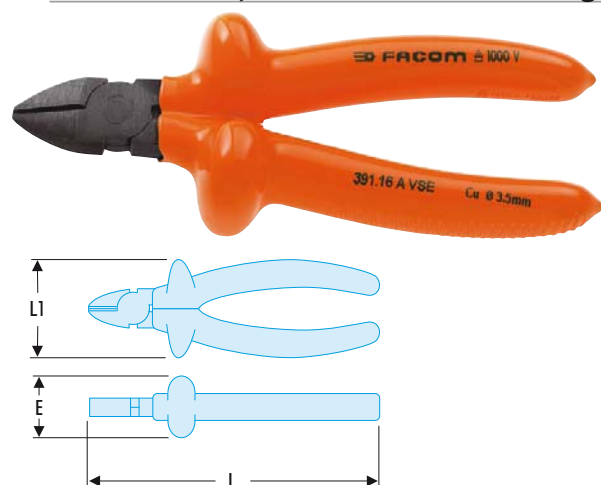

NF ISO 5749, ISO 5749, DIN ISO 5749, ASME B107.500

- Embedded meshing model.
- CU cutting diameter: 3.5 mm.
- Insulation with "safety" colour coding.
- Finish: burnished head.

➤	E [mm]	L [mm]	L1 [mm]	Cu - Ø max [mm]	ΔΔ [g]
391.16AVSE	35	165	70	3,5	270

■ VSE series 1,000 Volt insulated end nippers for hard wire

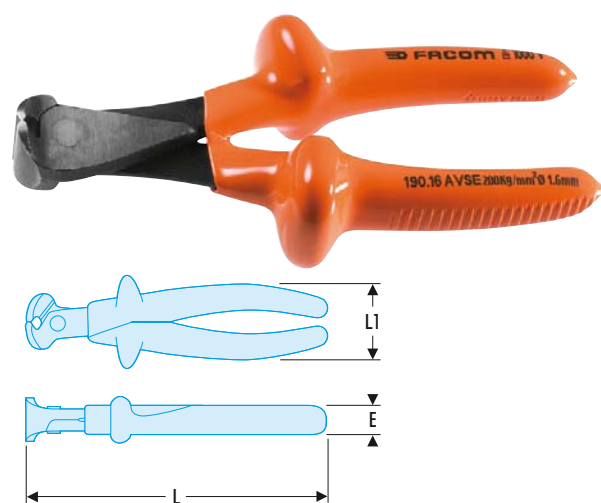

NF ISO 5748, NF EN 60900, ISO 5748, EN 60900, DIN ISO 5748, DIN EN 60900, ASME B107.500

- Tempered cutting edges for hardness above 60 HRc.
- Cutting diameter/200 kg/mm²: 1.6 mm.
- Insulation with "safety" colour coding.
- Finish: burnished head.

➤	E [mm]	L [mm]	L1 [mm]	200 kg/mm ² [Ø mm]	ΔΔ [g]
190.16AVSE	77	165	35	1,6	250

Combination pliers

■ 187.AVSE - VSE series 1,000 Volt insulated combination pliers

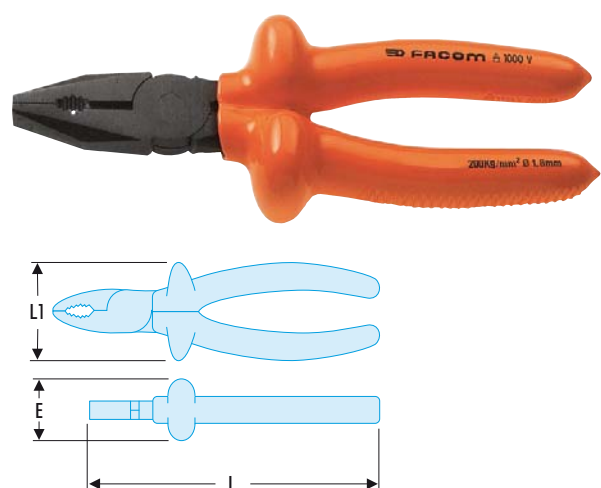

NF ISO 5746, NF EN 60900, ISO 5746, EN 60900, DIN ISO 5746, DIN EN 60900, ASME B107.500

- Tempered pliers for general strength.
- Second treatment on cutting edge for cutting edge hardness above 60 HRc.
- Insulation with "safety" colour coding.
- Finish: burnished head.

➤	E [mm]	L [mm]	L1 [mm]	140 kg/mm ² [Ø mm]	200 kg/mm ² [Ø mm]	Cu - Ø max [mm]	ΔΔ [g]
187.16AVSE	35	165	65	2,0	1,6	3,3	265
187.18AVSE	35	185	70	1,8	1,8	3,7	320
187.20AVSE	40	205	70	2,0	2,0	4,0	410

Grip pliers

■ VSE series 1,000 Volt insulated flat nose pliers

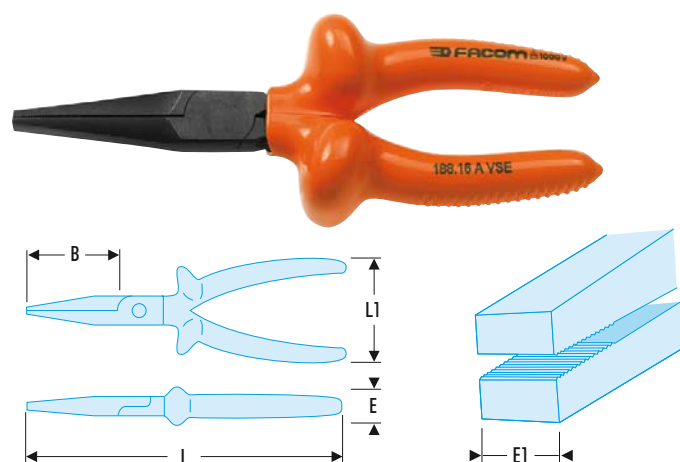

NF ISO 5746, NF EN 60900, ISO 5746, EN 60900, DIN ISO 5746, DIN EN 60900, ASME B107.500

- Serrated nose tips.
- Insulation with "safety" colour coding.
- Finish: burnished head.

➤	B [mm]	E [mm]	E1 [mm]	L [mm]	L1 [mm]	ΔΔ [g]
188.16AVSE	50	37	7	165	60	170

VSE series 1,000 Volt insulated semi-round nose pliers

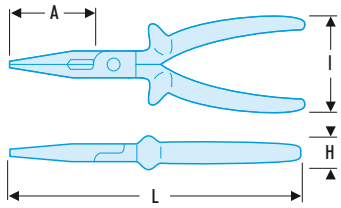

NF ISO 5745, ISO 5745, DIN ISO 5745, ASME B107.500

- Model with wire cutter.
- Serrated inner side of jaws facilitating grip.
- Insulation with "safety" colour coding.
- Finish: burnished head.

➤	A [mm]	E [mm]	L [mm]	L1 [mm]	140 kg/mm ² [∅ mm]	ΔΔ [g]
193.16AVSE	50	32	170	70	1,6	180

VSE series 1,000 Volt insulated long semi-round nose pliers

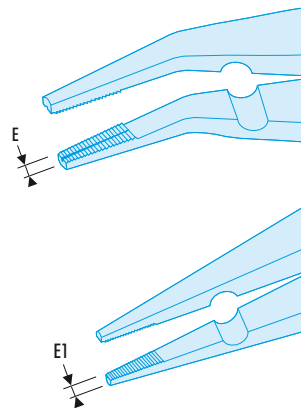
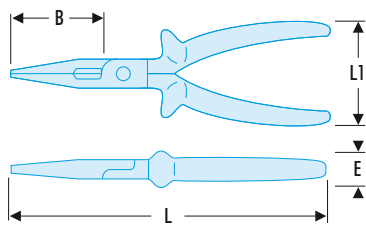

NF ISO 5745, NF EN 60900, ISO 5745, EN 60900, DIN ISO 5745, DIN EN 60900, ASME B107.500

- Models with wire cutter.
- Insulation with "safety" colour coding.
- Finish: burnished head.
- 185: straight nose.
- 195: angled nose.

➤	A [mm]	B [mm]	E1 [mm]	L [mm]	L1 [mm]	Cu - ∅ max [mm]	ΔΔ [g]
185.20AVSE	69	69	3,0	200	65	3,5	250
195.20AVSE	64	64	3,5	200	63	3,5	250

VSE series 1,000 Volt insulated round nose pliers

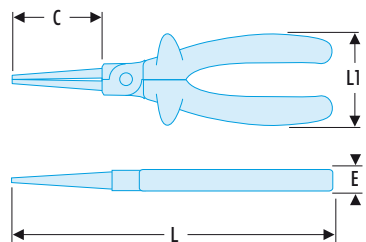

- Model with long, slim, serrated nose for making angles or terminals for all types of wires.
- Insulation with "safety" colour coding.
- Finish: burnished head.

➤	A [mm]	B [mm]	E [mm]	L [mm]	L1 [mm]	ΔΔ [g]
189.17AVSE	45	45	33	170	60	175

Wire strippers

VSE series 1,000 Volt insulated strippers

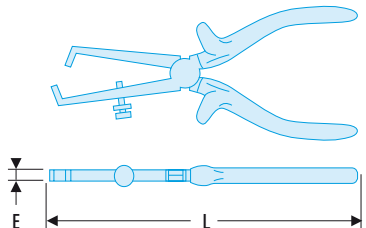

- Strips all current wires in electrical installations.
- Max diameter: 2.5 mm.
- Insulation with "safety" colour coding.
- Finish: burnished head.

➤	E [mm]	E1 [mm]	L [mm]	ΔΔ [g]
194.17AVSE	8	8	170	200

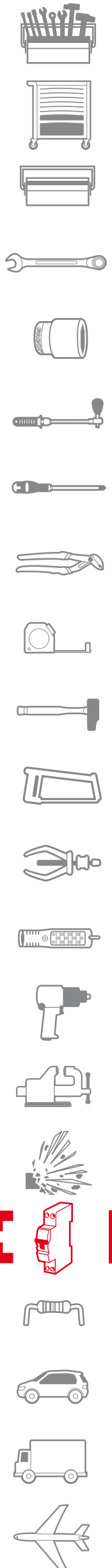

Cable cutter

412.AVSE - VSE series 1,000 Volt insulated copper-alu cable cutter



NF EN 60900, EN 60900, DIN EN 60900

- Particularly efficient for limited size.
- Forged safety stops.
- Insulation with "safety" colour coding.
- Finish: burnished head.

FACOM	B [mm]	B1 [mm]	E [mm]	E1 [mm]	L [mm]	L1 [mm]	Cu - Ø max [mm]	ΔΔ [g]
412.10AVSE	25	35	10	35	195	80	8	390
412.14AVSE	30	35	13	35	230	80	14	510
412.150AVSE	60	70	16	70	450	155	32	220

414.AVSE - VSE series 1,000 Volt insulated ratchet cable cutter



NF EN 60900, EN 60900, DIN EN 60900

- One-hand cutting.
- No distortion of the cable cut.
- Tempered forged steel blade.
- Insulation with "safety" colour coding.

414.45AVSE

- Cutting dimension: 45 mm.
- Max cutting cross-section copper 300 mm² and alu. 400 mm².
- Copper sector cable: 3x70.
- Alu sector cable: 4x70.

414.52AVSE

- Cutting dimension: 52 mm.
- Max cutting cross-section copper 400 mm².
- Max cutting cross-section HVA: 240 mm².
- LV sector cable: 3*150+70 or 3*240+95.

FACOM	B [mm]	E [mm]	L [mm]	ΔΔ [kg]
414.45AVSE	135	42	260	1,00
414.52AVSE	140	37	280	1,05

Hacksaw frame

602.AVSE SE series 1,000 Volt insulated hacksaw frame



NF E 73-073, NF EN 60900, EN 60900, DIN 6473, DIN EN 60900

- Hacksaw frame for 300 mm blade.
 - 2 blade positions.
 - Tension by wing nut.
 - Supplied with one bimetal blade.
 - Dimensions: 470 x 130 x 20 mm.
- Weight: 590 g

Knife

1820.AVSE VSE series 1,000 Volt insulated knife



NF EN 60900, EN 60900, DIN EN 60900

- Model with thick, angled, flat end blade.
 - Soft bi-material handle.
 - Storage case.
 - Active blade length: 60 mm.
 - Max dimensions: 185 x 52 x 25 mm.
- Weight: 90 g

Open-end wrenches

46.AVSE - VSE series 1,000 Volt insulated open end wrenches

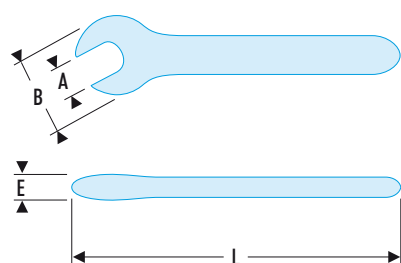

NF ISO 4229, NF EN 60900, ISO 4229, EN 60900, DIN 3114, DIN EN 60900

- Insulation with "safety" colour coding.

Model	A [mm]	B [mm]	E [mm]	L [mm]	ΔΔ [g]
46.8AVSE	8	22	8	105	30
46.9AVSE	9	24	9	105	35
46.10AVSE	10	25	9	105	40
46.11AVSE	11	29	10	115	50
46.12AVSE	12	30	10	125	60
46.13AVSE	13	32	11	135	70
46.14AVSE	14	34	11	145	80
46.15AVSE	15	36	11	145	90
46.16AVSE	16	38	12	155	105
46.17AVSE	17	41	12	155	120
46.18AVSE	18	42	12	160	135
46.19AVSE	19	45	12	165	150
46.21AVSE	21	50	14	185	180

Ring wrenches

55.AVSE - VSE series 1,000 Volt insulated offset ring wrenches

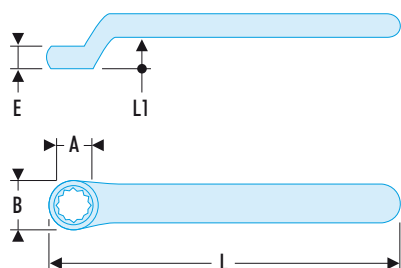

NF EN 60900, EN 60900, DIN EN 60900

- OGV® profile ring.
- Insulation with "safety" colour coding.

Model	A [mm]	B [mm]	E [mm]	L [mm]	L1 [mm]	ΔΔ [g]
55.8AVSE	8	16	8	150	16	50
55.9AVSE	9	17	9	151	17	55
55.10AVSE	10	19	9	157	17	60
55.11AVSE	11	20	10	160	19	70
55.12AVSE	12	21	11	165	20	100
55.13AVSE	13	23	12	165	20	105
55.14AVSE	14	25	12	180	21	120
55.15AVSE	15	26	12	183	21	130
55.16AVSE	16	27	13	195	26	160
55.17AVSE	17	30	14	198	27	180
55.18AVSE	18	30	14	215	27	200
55.19AVSE	19	32	14	215	27	205
55.21AVSE	21	35	16	245	31	300

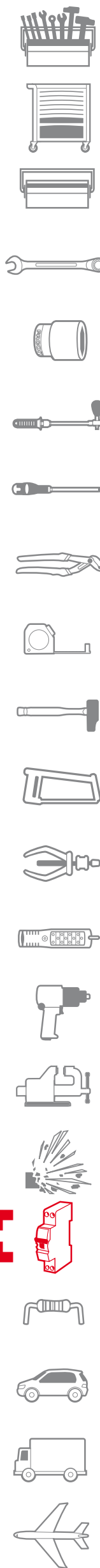

Adjustable wrenches

113.AVSE - VSE series 1,000 Volt insulated adjustable wrenches

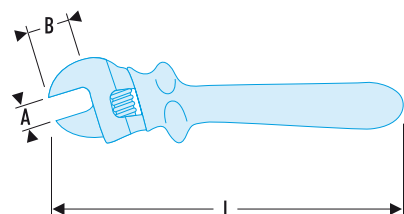

NF ISO 6787, NF EN 60900, ISO 6787, EN 60900, DIN EN 60900, ASME B107.100

- Models with finger stop.
- Worm: left-hand rotation.
- Insulation with "safety" colour coding.
- Finish: burnished.

➤	A [mm]	B [mm]	L [mm]	ΔΔ [g]
113.8TAVSE	27	24	210	385
113.10TAVSE	30	29	260	655
113.12TAVSE	34	34	310	950
113.15TAVSE	44	44	385	1935

Offset keys

83.AVSE - VSE series 1,000 Volt insulated keys

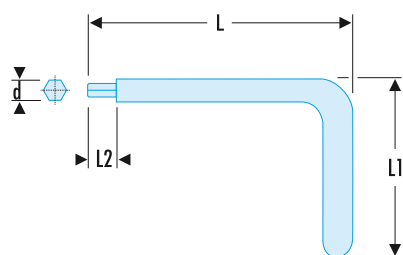
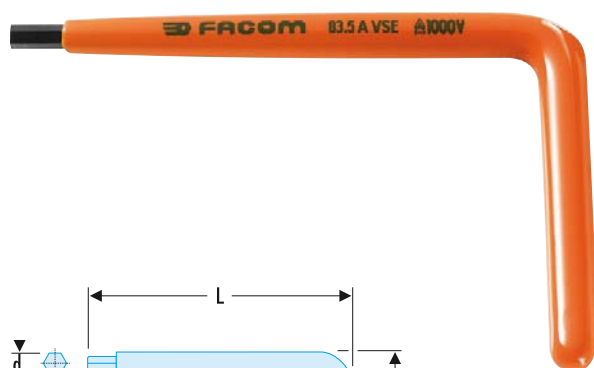

NF ISO 2936, NF EN 60900, ISO 2936, EN 60900, DIN ISO 2936, DIN EN 60900

- Key made in allied steel treated for strength above specifications of standards.
- Insulation with "safety" colour coding.

➤	d [mm]	L [mm]	L1 [mm]	L2 [mm]	ΔΔ [g]
83.3AVSE	3	125	85	12	20
83.4AVSE	4	125	85	12	30
83.5AVSE	5	125	85	12	50
83.6AVSE	6	125	85	12	70
83.8AVSE	8	125	85	12	110
83.10AVSE	10	125	85	12	150
83.12AVSE	12	125	85	12	210

Box wrenches

94T-TL.AVSE - VSE series 1,000 Volt insulated box wrenches

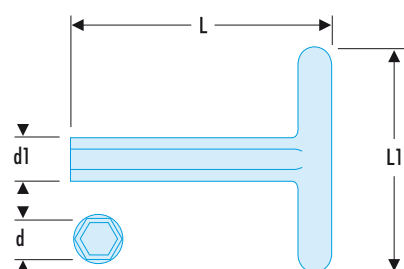

NF EN 60900, EN 60900, DIN EN 60900

- 94T.AVSE: box wrenches length 135 mm.
- 94TL.AVSE: box wrenches length 300 mm.

➤	d [mm]	d1 [mm]	L [mm]	L1 [mm]	ΔΔ [g]
94T.6AVSE	6	13	135	115	150
94T.8AVSE	8	15	135	115	160
94T.10AVSE	10	19	135	115	185
94T.11AVSE	11	23	135	115	185
94T.12AVSE	12	24	135	115	210
94T.13AVSE	13	25	135	115	225
94T.14AVSE	14	26	135	115	240
94TL.10AVSE	10	21	300	205	420
94TL.13AVSE	13	25	300	205	520
94TL.16AVSE	16	30	300	205	800
94TL.17AVSE	17	30	300	205	840
94TL.19AVSE	19	33	300	205	910

FACOM VSE 1,000 VOLT INSULATED RATCHETS AND SOCKETS

A COMPREHENSIVE RANGE OF TOOLS FOR WORKING ON LIVE COMPONENTS

- 1 Comprehensive range of accessories: extensions, Tee handles, etc.
- 2 Variety of socket lengths.
- 3 Square drives: 1/2", 3/8", 1/4" for overcoming accessibility problems.



And complete box sets.

Sockets 1/4"

R.AVSE - VSE series 1,000 Volt insulated 6-point 1/4" sockets

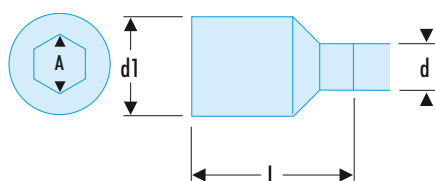

NF ISO 2725-1, NF ISO 1711-1, NF EN EN 60900, ISO 2725-1, ISO 1711-1, EN 60900, DIN 3124, DIN EN 60900, ASME B107.5

- Manual use sockets.
- Drive bit 1/4" - 6.35 mm.

	A [mm]	d [mm]	d1 [mm]	L [mm]	ΔΔ [g]
R.6AVSE	6	22	16	22	10
R.7AVSE	7	22	17	22	16
R.8AVSE	8	22	17	22	16
R.10AVSE	10	22	18	22	20
R.12AVSE	12	22	22	22	30

RT.AVSE - VSE series 1,000 Volt insulated 6-point 1/4" bit sockets

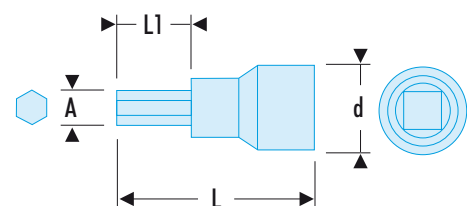

NF EN 60900, EN 60900, DIN EN 60900

- Manual use sockets.
- Drive bit 1/4" - 6.35 mm.

	A [mm]	d [mm]	L [mm]	L1 [mm]	ΔΔ [g]
RT.4AVSE	4	22	37	11	20
RT.5AVSE	5	22	37	13	20
RT.6AVSE	6	22	37	14	20

Ratchets and accessories 1/4"

R.151AVSE VSE series 1,000 Volt insulated 1/4" ratchet



NF ISO 3315, NF EN 60900, ISO 3315, EN 60900, DIN 3122, DIN EN 60900, ASME B107.10

- Drive bit 1/4" - 6.35 mm.
 - Sockets and accessories held by spring ball (9 N).
 - Insulation grip with "safety" colour coding.
 - Dimensions: 125 x 45 x 35 mm.
- Weight: 140 g

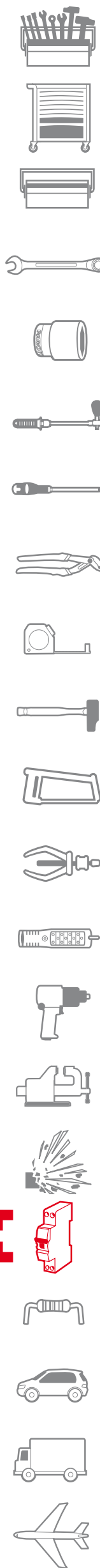

VSE series 1,000 Volt insulated tooling

▣ VSE series 1,000 Volt insulated 1/4" extension



NF ISO 3316, NF EN 60900, ISO 3316, EN 60900, DIN 3123, DIN EN 60900, ASME B107.10

- Drive bit 1/4" - 6.35 mm.

▣	d [mm]	L [mm]	ΔΔ [g]
R.210AVSE	16,6	116	65

Socket sets and accessories 1/4"

▣ R.400AVSE Set of 10 VSE series 1,000 Volt insulated tools



- Including:
 - 5 sockets 6, 7, 8, 10, 12 mm.
 - 3 6-point bit sockets 4, 5, 6 mm.
 - 1 ratchet R.151AVSE.
 - 1 extension R.210AVSE.
- Case dimensions: 322 x 136 x 53 mm.
- Weight: 650 g.

Sockets 3/8"

▣ J.AVSE - VSE series 1,000 Volt insulated 12-point 3/8" sockets

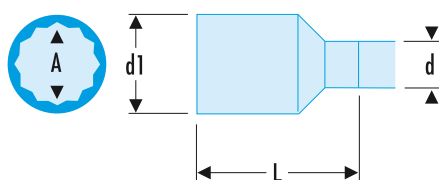

NF ISO 2725-1, NF ISO 1711-1, NF EN 60900, ISO 2725-1, ISO 1711-1, EN 60900, DIN 3124, DIN EN 60900, ASME B107.5

- Manual use sockets.
- Drive bit 3/8" - 9.53 mm.
- OGV® profile.

▣	A [mm]	d [mm]	d1 [mm]	L [mm]	ΔΔ [g]
J.8AVSE	8	18	17	43	30
J.10AVSE	10	18	18	43	34
J.11AVSE	11	18	20	43	35
J.12AVSE	12	18	21	46	35
J.13AVSE	13	18	22	46	45
J.14AVSE	14	18	23	46	45
J.15AVSE	15	18	25	46	45
J.16AVSE	16	18	25	46	45
J.17AVSE	17	18	27	46	48
J.18AVSE	18	18	27	46	66
J.19AVSE	19	18	29	50	68

Long reach sockets 3/8"

J.LAVSE - VSE series 1,000 Volt insulated long 12-point 3/8" sockets

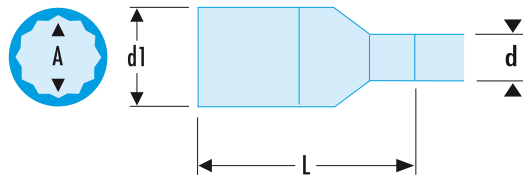

NF ISO 2725-1, NF ISO 1711-1, NF EN 60900, ISO 2725-1, ISO 1711-1, EN 60900, DIN 3124, DIN EN 60900, ASME B107.5

- Manual use sockets.
- Drive bit 3/8" - 9.53 mm.
- OGV® profile.

➤	A [mm]	d [mm]	d1 [mm]	L [mm]	ΔΔ [g]
J.8LAVSE	8	18	19	63	66
J.13LAVSE	13	18	23	63	75
J.14LAVSE	14	18	23	63	98
J.16LAVSE	16	18	25	69	147
J.17LAVSE	17	18	27	76	147
J.18LAVSE	18	18	28	76	157
J.19LAVSE	19	18	29	76	166

Bit sockets 3/8"

JT.AVSE - VSE series 1,000 Volt insulated male 6-point 3/8" bit sockets

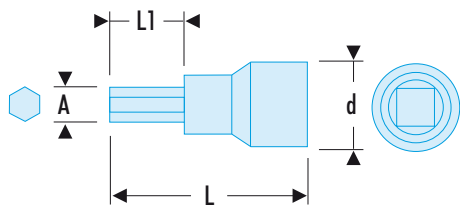

NF EN 60900, EN 60900, DIN EN 60900

- Manual use sockets.
- Drive bit 3/8" - 9.53 mm.

➤	A [mm]	d [mm]	L [mm]	L1 [mm]	ΔΔ [g]
JT.4AVSE	4	18	66	10	43
JT.5AVSE	5	18	66	10	43
JT.6AVSE	6	18	66	10	44
JT.7AVSE	7	18	66	10	48
JT.8AVSE	8	18	66	10	56
JT.10AVSE	10	18	66	10	63

Ratchets and accessories 3/8"

J.151AVSE VSE series 1,000 Volt insulated 3/8" ratchet



NF ISO 3315, NF EN 60900, ISO 3315, EN 60900, DIN 3122, DIN EN 60900, ASME B107.10

- Drive bit 3/8" - 9.53 mm.
- Sockets and accessories held by spring ball set (16 N).
- Insulation grip with "safety" colour coding.
- Dimensions: 180 x 50 x 48 mm.
- Weight: 250 g

J.121AVSE VSE series 1,000 Volt insulated 3/8" handle



NF EN 60900, EN 60900, DIN EN 60900, ASME B107.10

- Handle with drive bit 3/8" - 9.53 mm.
- Sockets and accessories held by spring ball set (16 N).
- Insulation grip with "safety" colour coding.
- Dimensions: 205 x 165 x 35 mm.
- Weight: 380 g



VSE series 1,000 Volt insulated tooling

▣ J.AVSE - VSE series 1,000 Volt insulated 3/8" extensions



NF ISO 3316, NF EN 60900, ISO 3316, EN 60900, DIN 3123, DIN EN 60900, ASME B107.10

- Drive bit 3/8" - 9.53 mm.

▣	d [mm]	L [mm]	ΔΔ [g]
J.210AVSE	17	150	150
J.215AVSE	17	260	290

Socket sets and accessories 3/8"

▣ J.400AVSE Set of 9 VSE series 1,000 Volt insulated tools



- Including:
 - 6 12-point sockets 8, 10, 11, 12, 13, 14 mm.
 - 1 ratchet J.151AVSE.
 - 2 extensions J.210AVSE, J.215AVSE.
- Dimensions: 390 x 160 x 68 mm.
- Weight: 1.740 kg

▣ J.401AVSE Set of 17 VSE series 1,000 Volt insulated tools



- Including:
 - 9 12-point sockets 8, 10, 11, 12, 13, 14, 15, 17, 19 mm.
 - 5 6-point bit sockets 4, 5, 6, 7, 8 mm.
 - 1 ratchet J.151AVSE.
 - 1 handle J.121AVSE.
 - 1 extension J.210AVSE.
- Dimensions: 345 x 280 x 65 mm.
- Weight: 2.250 kg

Sockets 1/2"

▣ S.AVSE - VSE series 1,000 Volt insulated 12-point 1/2" sockets



NF ISO 2725-1, NF ISO 1711-1, NF EN EN 60900, ISO 2725-1, ISO 1711-1, EN 60900, DIN 3124, DIN EN 60900, ASME B107.5

- Manual use sockets.
- Drive bit 1/2" - 12.7 mm.
- OGV® profile.

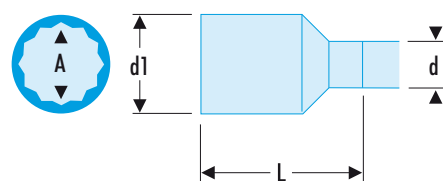

▣	A [mm]	d [mm]	d1 [mm]	L [mm]	ΔΔ [g]
S.8AVSE	8	22	17	52	70
S.9AVSE	9	22	18	52	70
S.10AVSE	10	22	19	52	75
S.11AVSE	11	22	20	52	75
S.12AVSE	12	22	22	52	75
S.13AVSE	13	22	23	52	75
S.14AVSE	14	22	24	52	80
S.17AVSE	17	22	28	52	90
S.19AVSE	19	22	32	52	95
S.21AVSE	21	22	33	52	130
S.22AVSE	22	22	34	52	145

Long reach sockets 1/2"

■ S.LAVSE - VSE series 1,000 Volt insulated long 12-point 1/2" sockets

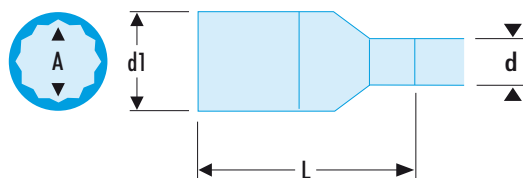

NF ISO 2725-1, NF ISO 1711-1, NF EN EN 60900, ISO 2725-1, ISO 1711-1, EN 60900, DIN 3124, DIN EN 60900, ASME B107.5

- Manual use sockets.
- Drive bit 1/2" - 12.7 mm.
- OGV® profile.

☞	A [mm]	d [mm]	d1 [mm]	L [mm]	ΔΔ [g]
S.12LAVSE	12	22	22	77	125
S.13LAVSE	13	22	23	77	135
S.14LAVSE	14	22	24	77	135
S.16LAVSE	16	22	27	77	150
S.17LAVSE	17	22	28	77	161
S.18LAVSE	18	22	29	77	167
S.19LAVSE	19	22	32	77	180

Bit sockets 1/2"

■ ST.AVSE - VSE series 1,000 Volt insulated male 6-point 1/2" bit sockets

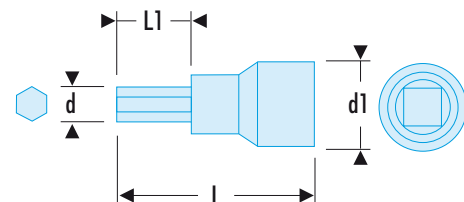

NF EN 60900, EN 60900, DIN EN 60900

- Manual use sockets.
- Drive bit 1/2" - 12.7 mm.

☞	d [mm]	d1 [mm]	L [mm]	L1 [mm]	ΔΔ [g]
ST.8AVSE	8	22	70	10	90
ST.10AVSE	10	22	70	12	90
ST.12AVSE	12	22	92	12	145
ST.14AVSE	14	22	92	17	150
ST.17AVSE	17	22	92	19	175

Ratchets and accessories 1/2"

■ S.151AVSE VSE series 1,000 Volt insulated 1/2" ratchet



NF ISO 3315, NF EN 60900, ISO 3315, EN 60900, DIN 3122, DIN EN 60900, ASME B107.10

- Drive bit 1/2" - 12.7 mm.
- Sockets and accessories held by spring ball set (38 N).
- Insulation grip with "safety" colour coding.
- Dimensions: 265 x 55 x 70 mm.
- Weight: 580 g

■ S.121AVSE VSE series 1,000 Volt insulated 1/2" handle



NF EN 60900, EN 60900, DIN EN 60900

- Handle with drive bit 1/2" - 12.7 mm.
- Sockets and accessories held by spring ball set (38 N).
- Insulation grip with "safety" colour coding.
- Dimensions: 210 x 165 x 25 mm.
- Weight: 520 g



▣ S.AVSE - VSE series 1,000 Volt insulated 1/2" extensions



NF ISO 3316, NF EN 60900, ISO 3316, EN 60900, DIN 3123, DIN EN 60900, ASME B107.10

- Drive bit 1/2" - 12.7 mm.

▣	d [mm]	L [mm]	ΔΔ [g]
S.210AVSE	22	145	250
S.215AVSE	22	145	470

Socket sets and accessories 1/2"

▣ S.400AVSE Set of 12 VSE series 1,000 Volt insulated tools



NF EN 60900, EN 60900, DIN EN 60900

- Including:
 - 9 12-point sockets 8, 9, 10, 11, 12, 13, 14, 17, 19 mm.
 - 1 ratchet S.151AVSE.
 - Extensions S.210AVSE and S.215AVSE .
- Dimensions: 390 x 160 x 68 mm.
- Weight: 2.460 kg

▣ S.401AVSE Set of 17 series 1,000 Volt insulated tools



NF EN 60900, EN 60900, DIN EN 60900

- Including:
 - 9 12-point sockets 8, 9, 10, 11, 12, 13, 14, 17, 19 mm.
 - 5 bit sockets 8, 10, 12, 14, 17 mm.
 - 1 ratchet S.151AVSE.
 - Handle S.121AVSE.
 - S.210AVSE Extension.
- Dimensions: 345 x 280 x 65 mm.
- Weight: 3.430 kg

Torque wrench

■ J.306-50VSE VSE series 1,000 Volt insulated torque wrench



NF EN ISO 6789, NF EN 60900, ISO 6789, EN 60900, DIN EN ISO 6789, DIN EN 60900

- Safe precision.
 - Adjustment system locking ring.
 - Wrench compliant with the ISO EN 6789 standard for torque control.
 - Accuracy + or - 4 % for 5,000 cycles min.
 - Automatic trigger and reset.
 - Re-calibratable wrench: typical procedure for torque wrenches.
 - Drive bit 3/8".
 - Capacity 10 to 50 N.m.
 - One-way wrench.
 - Wrench compliant with the EN 60900 standard for insulated tools.
 - Protection up to 1,000 Volt AC and 1500 Volt direct.
 - Wrench checked at dielectric test per unit on the manufacturing line.
 - Wrench supplied with inspection report.
 - Length: 380 mm.
- Weight: 1.274 kg

Insulated gloves

■ BC.VSE - Insulated gloves



NF EN 60903, EN 60903, DIN EN 60903

- Natural latex gloves, AZM classification:
 - Resistance to acid: A.
 - Resistance to ozone: Z.
 - High mechanical strength: M.
 - Length: 360 mm.
 - Supplied in anti-UV opaque bag.
- Weight: 150 g

Icon	Size [mm]	E [mm]	Class	Voltage/Volt
BC.80VSE	9 (B)	0,5	00	500
BC.81VSE	10 (C)	0,5	00	500
BC.90VSE	9 (B)	1,0	0	1000
BC.91VSE	10 (C)	1,0	0	1000

Safety overgloves

■ BC.VSE - Safety overgloves



NF EN 60903, EN 60903, DIN EN 60903

- Silicon coated leather gloves protecting from mechanical risks.
- Used to protect latex insulated gloves.
- Physical and mechanical grade as per standard EN 388: 2, 1, 2, 1.
- Abrasion: 2.
- Cuts: 1.
- Tears: 2.
- Perforation: 1.

Icon	Size [mm]	ΔΔ [g]
BC.109VSE	9 (B)	160
BC.110VSE	10 (C)	160

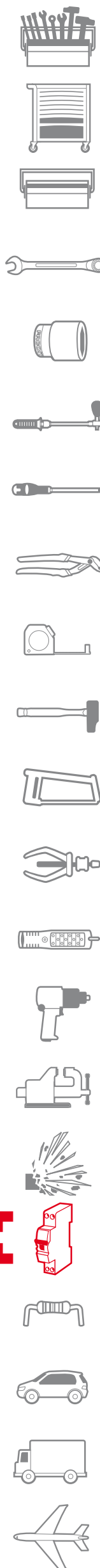

Insulated mats

BC.VSE - Insulated mats



NF C 18-421

- Rubber mat for insulation by cladding grounds.
- Thickness: 3.2 mm.
- Hardness: 60 DIDC.
- Dimensions:
 - BC.20VSE: 1 x 0,6 m.
 - BC.21VSE: 1 x 1 m.

⇒	ΔΔ [kg]
BC.20VSE	2,500
BC.21VSE	4,200

Insulated pliers

BC.25VSE Set of 4 insulated pliers



- Powerful clamping resin pliers for assembly of insulating mats.
- Fitted with a suspension hook.
- Max opening: 40 mm.
- Length: 155 mm.
- Weight: 70 g

Insulated tool sets

2180B.VSE 10-piece set of 1,000 Volt insulated tools



- Basic set for shop electrical maintenance.
- Supplied in leather bag BV.100.
- Dimensions: 350 x 120 x 120 mm.
- Weight: 2.025 kg.

⇒	Qtys	Set Description
BC.90VSE	1	Low temperature insulating gloves S9
189.17AVSE	1	1,000 Volt insulated round nose pliers
194.17AVSE	1	1,000 Volt insulated strippers
391.16AVSE	1	1,000 Volt insulated diagonal cutters for copper
187.18AVSE	1	1,000 Volt insulated combination pliers

⇒	Qtys	Set Description
1820.AVSE	1	1,000 Volt insulated knife
A4X100VE	1	1,000 Volt insulated screwdriver for slotted heads 4x100 mm
A5,5X150VE	1	1,000 Volt slotted head screwdrivers 5.5x150 mm
AP1X100VE	1	1,000 Volt screwdrivers for Phillips® PH 1 head
BV.100	1	Compact leather bag

2185C.VSE 20-piece set of 1,000 Volt insulated tools



- In chest with modular storage.
 - This general purpose selection includes 20 basic tools in a plastic box.
 - Volume available for additional tools.
 - Dimensions: 524 x 320 x 214 mm.
- Weight: 9.300 kg.

Icon	Qtys	Set Description
	1	Low temperature insulating gloves S9
	1	Safety overgloves S9
	1	Plastic folding rule (2 m)
	1	1,000 Volt insulated adjustable wrench 30 mm
	1	1/4" 1,000 Volt insulated tool set
	1	1,000 Volt insulated flat nose pliers
	1	1,000 Volt insulated cutters for hard wire
	1	1,000 Volt insulated strippers
	1	1,000 Volt insulated diagonal cutters for copper
	1	1,000 Volt insulated copper/aluminum cable cutter 14 mm
	1	1,000 Volt insulated knife
	1	1,000 Volt insulated combination pliers
	1	Voltage tester screwdriver 90 to 480 Volts

Icon	Qtys	Set Description
	1	1,000 Volt insulated screwdriver for slotted heads 4x100 mm
	1	1,000 Volt slotted head screwdrivers 5.5x150 mm
	1	1,000 Volt slotted head screwdrivers 6.5x150 mm
	1	1,000 Volt insulated screwdriver for slotted heads 8x125 mm
	1	1,000 Volt screwdrivers for Phillips® PH1 head
	1	1,000 Volt screwdrivers for Phillips® PH2 head
	1	Probox tool box

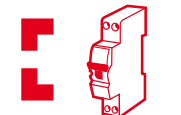
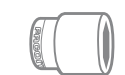

2187C.VSE 32-piece set of 1,000 Volt insulated tools



- For electrical equipment installers.
- Supplied in leather wallet BV.7A.
- Dimensions: 445 x 330 x 185 mm.
- Weight: 8.500 kg.

➤	Qtys	Set Description
BC.90VSE	1	Low temperature insulating gloves S9
BC.109VSE	1	Safety overgloves S9
R.400AVSE	1	10-piece 1/4" insulated tool set
113.10TAVSE	1	1,000 Volt insulated adjustable wrench 30 mm
188.16AVSE	1	1,000 Volt insulated flat nose pliers
194.17AVSE	1	1,000 Volt insulated strippers
391.16AVSE	1	1,000 Volt insulated copper diagonal cutters
189.17AVSE	1	1,000 Volt insulated round nose pliers
187.18AVSE	1	1,000 Volt insulated combination pliers
412.14AVSE	1	1,000 Volt copper/alu cable cutter 14 mm
AV.HT1B	1	Voltage tester screwdriver 90 to 480 V
701B	1	Multifunction tester
46.8AVSE	1	1,000 Volt insulated open-end wrench 8 mm
46.10AVSE	1	1,000 Volt insulated open-end wrench 10 mm
46.11AVSE	1	1,000 Volt insulated open-end wrench 11 mm
46.12AVSE	1	1,000 Volt insulated open-end wrench 12 mm
46.13AVSE	1	1,000 Volt insulated open-end wrench 13 mm
46.14AVSE	1	1,000 Volt insulated open-end wrench 14 mm
46.17AVSE	1	1,000 Volt insulated open-end wrench 17 mm

➤	Qtys	Set Description
46.19AVSE	1	1,000 Volt insulated open-end wrench 19 mm
83.3AVSE	1	1,000 Volt insulated keys 3 mm
83.4AVSE	1	1,000 Volt insulated keys 4 mm
83.6AVSE	1	1,000 Volt insulated keys 6 mm
A3,5X100VE	1	1,000 Volt insulated slotted head screwdrivers 3.5x100 mm
A4X100VE	1	1,000 Volt insulated screwdriver for slotted heads 4x100 mm
A5,5X150VE	1	1,000 Volt slotted head screwdrivers 5.5x150 mm
A6,5X150VE	1	1,000 Volt slotted head screwdrivers 6.5x150 mm
A8X150VE	1	1,000 Volt insulated screwdriver for slotted heads 8x150 mm
APOX75VE	1	1,000 Volt screwdrivers for Phillips® PH 0 head
AP1X100VE	1	1,000 Volt screwdrivers for Phillips® PH 1 head
AP2X125VE	1	1,000 Volt screwdrivers for Phillips® PH 2 head
BV.7A	1	Folding front panel leather case

2184C.VSE 41-piece set of 1,000 Volt insulated tools



- For electrical equipment shops, worksites.
- Supplied in leather case BV.5A.
- Dimensions: 425 x 215 x 320 mm.
- Weight: 14.130 kg.

Code	Qtys	Set Description
BC.20VSE	1	Insulating mat 1 m x 0.6 m
BC.90VSE	1	Low temperature insulating gloves S9
180.VSE	1	1,000 Volt insulated multiple grip pliers
188.16AVSE	1	1,000 Volt insulated flat nose pliers
195.20AVSE	1	1,000 Volt insulated long half-round nose pliers
190.16AVSE	1	1,000 Volt insulated cutters for hard wire
192.16AVSE	1	1,000 Volt insulated cutters for hard wire
391.16AVSE	1	1,000 Volt insulated copper diagonal cutters 14 mm
189.17AVSE	1	1,000 Volt insulated round nose pliers
187.18AVSE	1	1,000 Volt insulated combination pliers
194.17AVSE	1	1,000 Volt insulated strippers
412.14AVSE	1	1,000 Volt insulated copper-alu cable cutter 14 mm
414.45AVSE	1	1,000 Volt insulated ratchet cable cutter 45 mm
46.8AVSE	1	1,000 Volt insulated open-end wrench 8 mm
46.10AVSE	1	1,000 Volt insulated open-end wrench 10 mm
46.12AVSE	1	1,000 Volt insulated open-end wrench 12 mm
46.13AVSE	1	1,000 Volt insulated open-end wrench 13 mm
46.14AVSE	1	1,000 Volt insulated open-end wrench 14 mm
46.17AVSE	1	1,000 Volt insulated open-end wrench 17 mm
46.19AVSE	1	1,000 Volt insulated open-end wrench 19 mm
46.21AVSE	1	1,000 Volt insulated open-end wrench 21 mm
701B	1	Multifunction tester
83.3AVSE	1	1,000 Volt insulated keys 3 mm
83.4AVSE	1	1,000 Volt insulated keys 4 mm

Code	Qtys	Set Description
83.6AVSE	1	1,000 Volt insulated keys 6 mm
94T.8AVSE	1	1,000 Volt insulated box wrench 8 mm
94T.10AVSE	1	1,000 Volt insulated box wrench 10 mm
94T.13AVSE	1	1,000 Volt insulated box wrench 13 mm
1820.AVSE	1	1,000 Volt insulated knife
DELA.401.00	1	Synthetic folding rule 2 m
A3,5X100VE	1	1,000 Volt insulated slotted head screwdrivers 3.5x100 mm
A4X100VE	1	1,000 Volt insulated screwdriver for slotted heads 4x100 mm
A5,5X150VE	1	1,000 Volt slotted head screwdrivers 5.5x150 mm
A6,5X150VE	1	1,000 Volt slotted head screwdrivers 6.5x150 mm
A8X150VE	1	1,000 Volt insulated screwdriver for slotted heads 8x150 mm
A10X200VE	1	1,000 Volt insulated screwdriver for slotted heads 10x200 mm
AP1X100VE	1	1,000 Volt screwdrivers for Phillips® PH 1 head
AP2X125VE	1	1,000 Volt screwdrivers for Phillips® PH 2 head
AD1X100VE	1	1,000 Volt screwdrivers for Pozidriv® PZ 1 heads
AD2X125VE	1	1,000 Volt screwdrivers for Pozidriv® PZ 2 heads
BV.5A	1	Leather case with drawers



ELECTRICIANS SELECTIONS

➤ FOR THE ELECTRICIANS SELECTIONS, SEE P. 30 TO 34 IN SECTION 1.



志發

CHEE FATT

W : www.cheefatt.com

E : marketing@cheefatt.com

T : +65 6294 2066