



## 1/4" "RADIO" RANGE

237



1/4" socket sets .....	237
1/4" ratchets .....	245
1/4" accessories.....	247
1/4" sockets .....	252
1/4" long reach sockets.....	254
1/4" Torx® sockets.....	255
1/4" screwdriver sockets.....	255

## 1/2" "STANDARD" RANGE

276



1/2" socket sets .....	276
1/2" ratchets .....	289
1/2" accessories.....	292
1/2" sockets.....	297
1/2" Torx® sockets.....	300
1/2" screwdriver sockets.....	300

## 3/8" "JUNIOR" RANGE

257



3/8" socket sets .....	257
3/8" ratchets .....	264
3/8" accessories.....	266
3/8" sockets .....	271
3/8" Torx® sockets.....	274
3/8" screwdriver sockets.....	274

## 3/4" "TRUCK" RANGE

303



3/4" socket sets .....	303
3/4" ratchets .....	309
3/4" accessories.....	311
3/4" sockets.....	314



## 1" "MAMMOUTH" RANGE

316



1" socket sets .....	316
1" ratchets and accessories .....	317
1" sockets .....	318

## "IMPACT" RANGE

319



3/8" impact sockets and accessories.....	321
1/2" impact sockets and accessories.....	323
3/4" impact sockets and accessories.....	331
1" impact sockets and accessories.....	334
1" 1/2" impact sockets and accessories.....	337

## DYNAPACT MANUAL IMPACT WRENCHES

339



Impact screwdrivers	
↳ See section 7 in page .....	464



# CHOOSING YOUR SOCKETS

## RANGE, PERFORMANCE AND SAFETY BY FACOM

### RANGE







- The FACOM range includes over 1500 different ratchets, sockets, accessories and sets to meet your every need, from light engineering to power-assisted work or live working applications.

### PERFORMANCE













- The performance of Facom's ratchets, sockets and accessories greatly exceeds current standard specifications.

### SAFETY

- For your safety always observe colour codes as well as safety instructions
  - Chrome finish: manual use only.
  - Black: use with impact or power tools.
  - Orange: live, manual use
  - Bronze/Copper: use in explosive atmosphere.

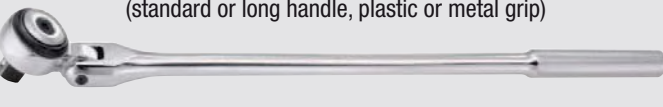
COLOUR OF THE SOCKET OR ACCESSORY	USE	DIMENSIONS	SQUARE DRIVE	
Chromed 	Light engineering Electronics Electromechanical Cycles	3.2 to 14 mm 3/16" to 9/16"	Radio range 1/4"	<b>p. 250</b>
Chromed 	Mechanical engineering Automotive engineering	7 to 24 mm 1/4" to 1"	Junior range 3/8"	<b>p. 258</b>
	Motorcycles	8 to 34 mm 1/4" to 1"	Standard range 1/2"	<b>p. 276</b>
Chromed 	Mechanical engineering Heavy goods vehicles Civil engineering plant	19 to 55 mm 3/4" to 2"1/4"	Truck range 3/4"	<b>p. 393</b>
	Farming equipment Offshore	41 to 100 mm 1"13/16 to 3"3/8"	Mammoth range 1"	<b>p. 316</b>
Black 	For all your power-assisted torquing applications	6 to 120 mm 3/8" to 2"1/8"	Impact range 3/8", 1/2", 3/4", 1", 1"1/2" Manual impact wrenches Power-assisted impact machines Power-assisted bolters	<b>p. 320</b> <b>p. 678</b> <b>p. 712</b> <b>p. 691</b>
Orange 	For all live working applications	Sockets 6 to 12 mm Sockets 9 to 19 mm Sockets 8 to 22 mm	Radio 1/4" Junior 3/8" Standard 1/2"	<b>p. 803</b> <b>p. 804</b> <b>p. 806</b>
Copper-Beryllium 	For all work in explosive atmosphere	See = ADF range		<b>p. 738</b>

# CHOOSE YOUR RATCHET

USE	OFFER	OTHER BENEFITS	
Standard	<p><b>Pear head ratchets</b> Ideal: these ratchets are ideal for use in difficult working conditions.</p> 	Very compact Precise palm control	Square: 1/4"-3/8"-1/2" <b>RL.161</b> <b>JL.161</b> <b>SL.161</b>
	<p><b>Palm control ratchets</b> FACOM tradition. Ring reversing. The palm-control system allows the operator to push down on the head of the ratchet while avoiding accidental reversal.</p> 	Precise	Square: 1/4"-3/8"-1/2" <b>R.161</b> <b>J.161</b> <b>S.161</b>
	<p><b>Standard ratchets</b> Classical cap reversing line.</p> 		Square: 1/4"-3/8"-1/2"-3/4"-1" <b>R.151 - J.151 - S.151</b> <b>K.152 - K.149 - K.154B</b> <b>M.151</b>
Speed & productivity	<p><b>Fast ratchets</b> Work faster in confined areas.</p> 	Socket locking Palm control	Square: 1/4" - 3/8" - 1/2": <b>R.360</b> <b>J.360</b> <b>S.360</b>
Powerful / Reduced efforts	<p><b>Long ratchets</b> Less fatigue during applications requiring high torque.</p> 		Square: 3/8"-1/2"-3/4"- 1" <b>J.174 - S.154</b> <b>K.154B</b> <b>K.151B + K.126A</b> <b>M.151 + M.126</b>
	<p><b>Long hinged ratchets</b> Combine joint for access &amp; long handle to reduce efforts and fatigue during applications requiring high torque (handle with plastic or metal grip).</p> 	Palm control	Square: 3/8"-1/2" <b>J.153A</b> <b>S.153A</b> <b>J.158A</b> <b>S.158A</b>
Locking of sockets and accessories	<p>Sockets and accessories secured to avoid any risk falling particularly in confined spaces.</p> 	Palm control	Square: 1/4" - 3/8" - 1/2" <b>R.360 - J.360</b> <b>S.360 - J.171</b> <b>J.174 - S.171</b>
Access	<p><b>Hinged head ratchets</b> (standard or long handle, plastic or metal grip)</p> 	Palm control	Square: 1/4" - 3/8" - 1/2" <b>S.143A - S.153A</b> <b>S.158A - J.153A</b> <b>J.158A - R.158A</b>
	<p><b>Ultra-compact bit ratchet</b> Design halving size compared with a standard ratchet.</p> 	Allows also to use sockets with ECR adapter	<b>R.PE</b> Square: 1/4": R.PE <b>65.PE</b>
	<p><b>Ratchet without handle</b> For manual access with/without extension in confined spaces</p> 		Square: 1/4" <b>R.150A</b>
Others	<p><b>Intermediate ratchets</b> To use with tee or hinged handle.</p>  		Square: 3/8" - 1/2" <b>J.156</b> <b>S.156</b>



# PEAR HEAD RATCHETS

RL-JL-SL.161

## SEALED AND ROBUST

### ULTRA-RESISTANT AND SEALED HEAD FOR LONGER LIFETIME

- Double sealing gasket: mechanism sealed to industrial dust.
- Maintenance free.
- Tested in aggressive conditions.

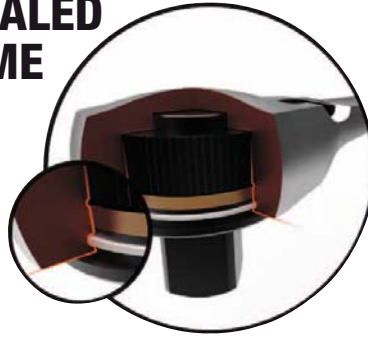

### ULTRA-COMPACT HEAD

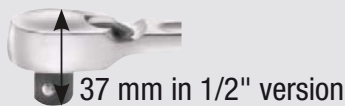

### HIGH PRECISION

- 72 teeth for 5° increments.

### REDUCED FATIGUE:

- Lighter 1/2" ratchet (-15% for S.161, -25% for 1/2" traditional lever ratchets.)
- Center of gravity moved towards the head for easier increment movements.

### PALM CONTROL SYSTEM

- For more powerful loosening.



### RECESSED REVERSE LEVER

Avoids accidental reversal and is easier to operate with gloved hands.



### COMFORTABLE:

No discontinuity between the plastic and metal sections.

### HOOKING EYE

Icon	Square drive
	Square drive
<b>RL.161</b>	1/4"
<b>JL.161</b>	3/8"
<b>SL.161</b>	1/2"



# THE FAST RATCHET WITH ROTATING HANDLE

## WORK TWICE AS FAST WITH THE ROTATING HANDLE

- The rotating handle allows fast access to improve productivity.
- Gain time, especially in confined work spaces.



## MAXIMUM COMFORT

- No need to hold the socket in the access phase = just place the socket on the screen and turn the handle.
- More comfort and access, especially in confined work spaces.

## SOCKET LOCKING

- No need to secure the socket by hand when tightening threads or nuts with little or no locking.

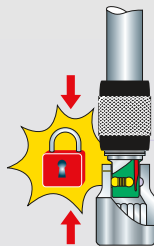

## PALM CONTROL

- Ratchet head can be pressed for more powerful (un)tightening.



Model	Square drive
<b>R.360</b>	1/4"
<b>J.360</b>	3/8"
<b>S.360</b>	1/2"

- Also available in NANO and DETECTION BOXES.

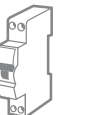
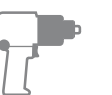

**RATCHETS AND ACCESSORIES WITH SAFETY LOCK**

The Facom range of 1/4" and 1/2" ratchets and accessories prevents any accidental loss of sockets in your work space.

**Locking mechanism**

Resistant to more than 60 kg traction before socket tearing.

**Instant release thanks to**

- The knurled ring of the extensions,
- Releasing the ratchet for instant ejection of the socket by simple pressure, even with slippery hands.

Ratchets	Extensions	Square drive
R.360	R.210RC	1/4"
	R.215RC	
	R.217RC	
J.360	J.210RC	3/8"
J.171	J.215RC	
J.174	J.217RC	
S.360	S.210RC	1/2"
S.171	S.215RC	
	S.217RC	

For your safety, only use ratchets and accessories with sockets with an internal ball notch.

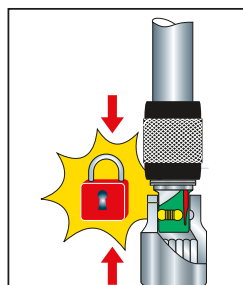

Locking mechanism



Instant release

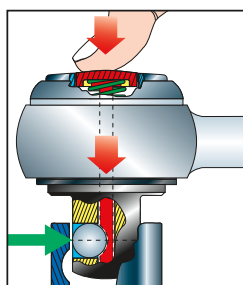

Sockets with ball notch

S.171



**FACOM OGV® PROFILE**

**FACOM OGV® PROFILE**

- More powerful tightening.
- Safer by strongly reducing the risk of slippage, particularly on rounded nuts.

Standard profile

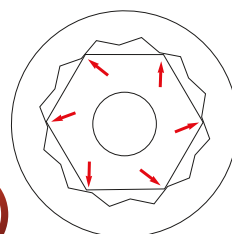

Stress applied to edges

OGV®

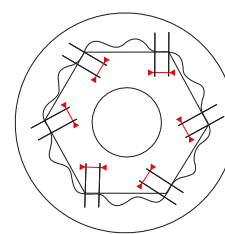

Bears against the side faces

# THE ULTRA-COMPACT BIT RATCHET

**THE FACOM R.PE RATCHET WAS DEVELOPED TO DELIVER MAXIMUM POWER AND COMPACTNESS WHEN USING BITS.**

## MAXIMUM COMPACTNESS

The design of the R.PE allows insertion of the bit in the mechanism while halving the height compared with a standard ratchet. Therefore, it is the most compact in the market at this level of performance.



## COMPATIBLE WITH 1/4" SOCKETS

With the ECR adapter,

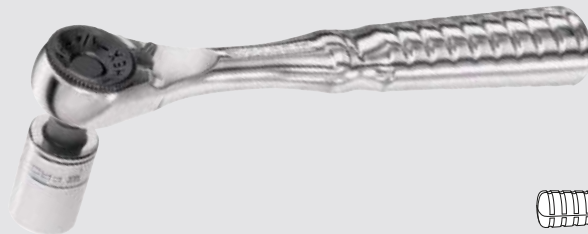

## WORK FASTER

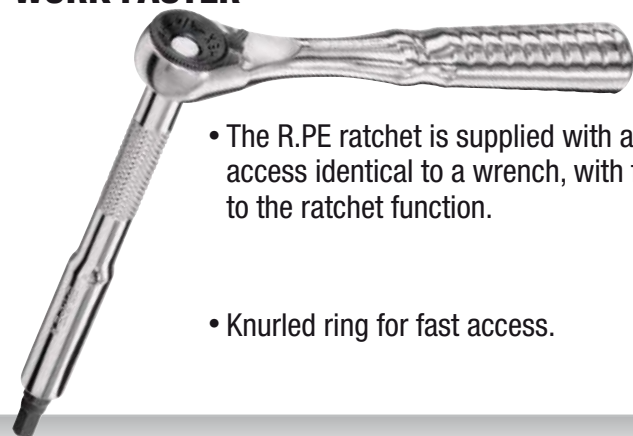

- The R.PE ratchet is supplied with a 100 mm extension: access identical to a wrench, with faster operation thanks to the ratchet function.
- Knurled ring for fast access.

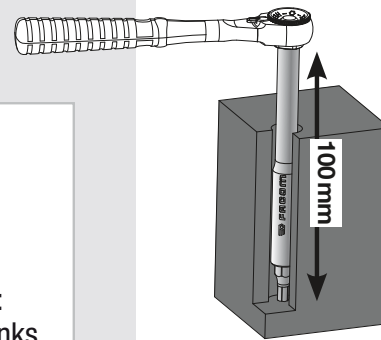

## THE ULTRA COMPACT R.PE RATCHET AND BIT TOOL SET

### COMPLETE SET

- Torx® bits: T6 to T40.
- Hexagonal bits: 1.5 mm to 8 mm.
- Bits PH no.1 - 2 - 3 / PE no.1 - 2 - 3 / Slotted head 4 - 5.5 mm.
- Adaptor for sockets.
- Extension 100 mm.

### ULTRA-COMPACT

- 124 mm x 34 mm x 64 mm.

### PRACTICAL

- Fast tool selection.
- Anti slip tool grip.

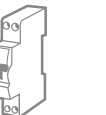
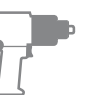
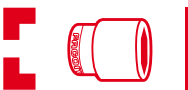



# STORING YOUR SOCKETS

SOCKET STORAGE SYSTEMS ARE ADAPTED TO YOUR NEEDS ON THE MOVE OR WHEN WORKING IN THE WORKSHOP AND TO YOUR WORK CONSTRAINTS.

COMPACT

ON-SITE APPLICATIONS

WORKSHOP WORK

**NANO Box concept**  
• Square: 1/4".



**DETECTION Box Concept**  
• Square drive: 1/2"-3/8".



FOD compatible.

**Polypropylene boxes or metal boxes**  
• Square: 1/4"-3/8"-1/2"-3/4"-1".



**Modules with thermoformed trays**  
• Square drive: 1/4"-3/8"-1/2"-3/4".



**MOD.J1**

**Modules with foam trays**  
• Square drive: 1/4"-3/8"-1/2".



**MODM.R1A**

FOD compatible.

**SAFETY AND EFFICIENCY**

# THE RNANO CONCEPT

## ULTRA-COMPLETE: 100% BOLTING-TIGHTENING

- Up to 38 tools, 1/4" drive square, in metric or inch dimensions, 6-or 12- point sockets, with standard / pear head / fast ratchet.

## ULTRA-COMPACT

- 50% more compact than 1/4" sets in regular box.

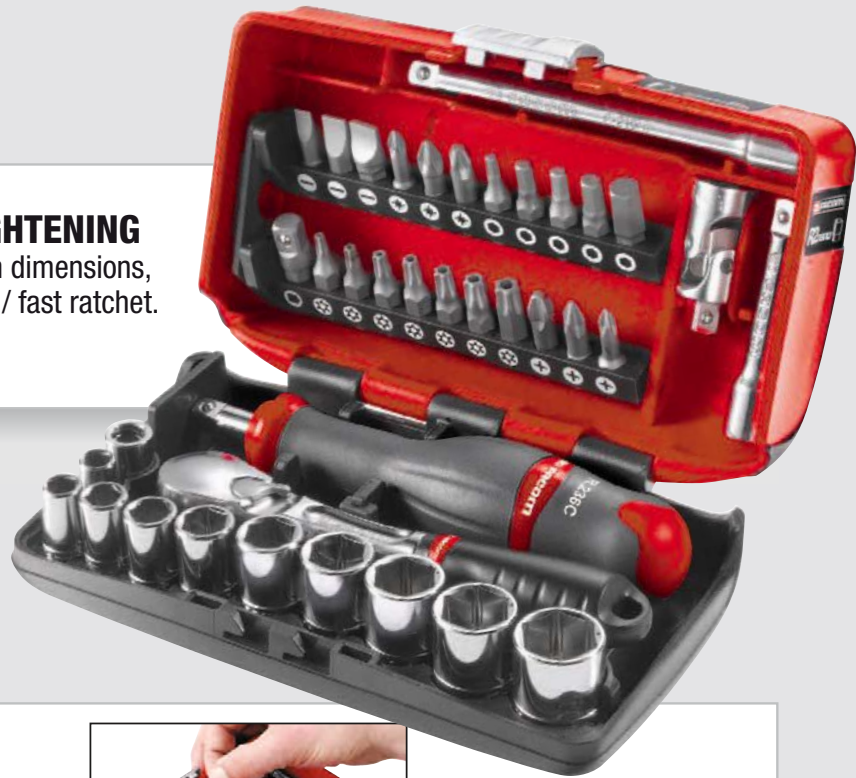

## PRACTICAL: SAVE TIME

- Easy set and tool selection thanks to tool pattern tag,
- Thanks to 3-sided set identification sticker.



## Easy tool picking

- Bit strips rise automatically when opening the set.



- Socket picking by tilting.



- Auto-closing clasp: closes instantly.



## Sockets, bits, and accessories held in case of tipping



## STRENGTH AND COMFORT BY FACOM

- Sturdy closing system: metal clasp and hinge rod
- Bi-material body: - Box frame in PC/B > Rigid and unbreakable.
  - Skin in TPU = soft anti-slip > Good grip
    - > Does not slip on work surface
    - > Does not scratch the intervention zone (bodywork...)
- Plastic resistant to workshop solvents.

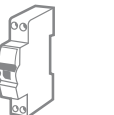
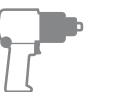
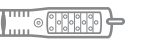

# DETECTION BOX CONCEPT

## REINFORCED SAFETY

- The "Detection BOX" concept ensures instant availability check even when the box is closed.



## EASY TO STORE

- Easy storage in all roller cabinet drawers (including 60 mm high).
- Adapts to 1/3 width of a roller cabinet module.
- Holds vertically.
- Does not slide, even on a smooth surface.



## EASY TO CARRY

- With the extension used as a handle.

## PRACTICAL

- Sockets locked securely in their slots and stay in place even when set is tipped over.



















## HIGH STRENGTH

- Thanks to their bi-material shell, metal clasps and metal hinge pins.



# 1/4" NANO SETS

## METRIC DIMENSIONS

		RL.NANO1	RL.NANO112	R.360NANO	R2NANO	
		RL.161	RL.161	R.360	R.161	
		6	12	6	6	
 1/4" 6,35 mm		1/4"	1/4"	1/4"	1/4"	
 mm	5,5	•	•	•	•	
	6	•	•	•	•	
	7	•	•	•	•	
	8	•	•	•	•	
	9	•	•	•	•	
	10	•	•	•	•	
	11	•	•	•	•	
	12	•	•	•	•	
 EP	1	•	•	•	•	
	 2	•	•	•	•	
	3	•	•	•	•	
	 EH	3	•	•	•	•
		4	•	•	•	•
		5	•	•	•	•
	mm	6	•	•	•	•
7		•	•	•	•	
 ED	1	•	•	•	•	
	2	•	•	•	•	
	3	•	•	•	•	
 ES	4,5	•	•	•	•	
	6,5	•	•	•	•	
	8	•	•	•	•	
 EXR	10	•	•	•	•	
	15	•	•	•	•	
	20	•	•	•	•	
	25	•	•	•	•	
	27	•	•	•	•	
	30	•	•	•	•	
	40	•	•	•	•	
 R.209	R.209	•	•	•	•	
 R.210	R.210	•	•	•	•	
 R.240A	R.240A	•	•	•	•	
 R.235	R.235	•	•	•	•	
 R.236A	R.236A	•	•	•	•	
 ECR	ECR	•	•	•	•	
		BV.NANO1				
		152 x 48 x 92 mm				
		0,81 Kg	0,745 Kg	0,85 Kg	0,85 Kg	

RL.NANO1



RL.NANO112



R.360NANO





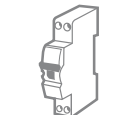
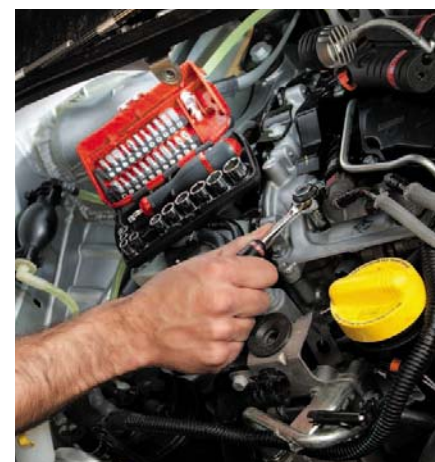











R2NANO

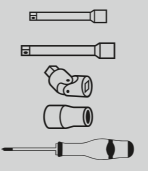

# 1/4" NANO SETS

## INCH DIMENSIONS

			RL.NANO-U1	RL.NANO-U112	RL.NANO-U2	R.360NANO-U1	R.360NANO-U112
			RL.161	RL.161	RL.161	R.360	R.360
 12 6			6	12	12	6	12
 1/4" 6,35 mm			1/4"	1/4"	1/4"	1/4"	1/4"
	"	7/32	•	•	•	•	•
		1/4	•	•	•	•	•
		9/32	•	•	•	•	•
		5/16	•	•	•	•	•
		11/32	•	•	•	•	•
		3/8	•	•	•	•	•
		13/32	•	•	•	•	•
		7/16	•	•	•	•	•
		1/2	•	•	•	•	•
9/16	•	•	•	•	•		
	EP	1	•	•	•	•	•
		2	•	•	•	•	•
		3	•	•	•	•	•
	EH	1/4	•	•	•	•	•
		1/8	•	•	•	•	•
		3/16	•	•	•	•	•
		5/32	•	•	•	•	•
		7/32	•	•	•	•	•
	ED	1	•	•	•	•	•
		2	•	•	•	•	•
		3	•	•	•	•	•
	ES	4,5	•	•	•	•	•
		6,5	•	•	•	•	•
		8	•	•	•	•	•
TORX®		8	•	•	•	•	•
	EXR	10	•	•	•	•	•
		15	•	•	•	•	•
		20	•	•	•	•	•
		25	•	•	•	•	•
		27	•	•	•	•	•
		30	•	•	•	•	•
		40	•	•	•	•	•
	R.209	•	•	•	•	•	
	R.210	•	•	•	•	•	
	R.240A	•	•	•	•	•	
	R.235	•	•	•	•	•	
	R.236C	•	•	•	•	•	
ECR		•	•	•	•	•	
			BV.RNANO-U				
			152 x 48 x 92 mm				
			0,81 Kg	0,745 Kg	0,81 Kg	0,90 Kg	0,85 Kg

**RL.NANO-U1**



**RL.NANO-U112**



**RL.NANO-U2**



**R.360NANO-U1**

























**R.360NANO-U112**



# 1/4" CLASSICAL SETS



















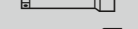
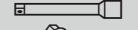

## METRIC DIMENSIONS

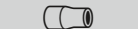
		R.3A	R.410AE	R.410D	R.420P	R.425AP	R.426AP	R.425A
 12 6		R.161	R.151	R.151	R.161	R.161	R.161	R.151
1/4" 6,35 mm		1/4"	1/4"	1/4"	1/4"	1/4"	1/4"	1/4"
 mm	3,2				•			
	4		•		•			
	5		•		•			
	5,5	•	•	•	•	•	•	•
	6	•	•	•	•	•	•	•
	7	•	•	•	•	•	•	•
	8	•	•	•	•	•	•	•
	9	•	•	•	•	•	•	•
	10	•	•	•	•	•	•	•
	11	•	•	•	•	•	•	•
12	•	•	•	•	•	•	•	
13	•	•	•	•	•	•	•	
14			•	•	•	•	•	
 EP	1				•	•	•	•
	2				•	•	•	•
	3							
 EH	3				•	•	•	•
	4				•	•	•	•
	5				•	•	•	•
	6				•	•	•	•
 mm	7							
	8							
 ED	1	•						
	2	•						
	3	•						
 ES	4				•	•	•	•
	4,5							
	5,5							
	6,5				•	•	•	•
 8	8				•	•	•	•
 EXR	10							
	15	•						
	20	•						
	25	•						
	27							
	30	•						
40	•							
 R.209	R.209				•	•	•	•
 R.210	R.210	•	•		•	•	•	
 R.215	R.215			•	•	•	•	
 R.240A	R.240A			•	•	•	•	
 R.235	R.235	•			•	•	•	
 R.236A	R.236A	•	•	•	•	•	•	
 R.120A	R.120A			•	•	•	•	
 R.222	R.222							
 R.142	R.142							
		PL.366A	PL.390A	PL.244A	PL.442		PL.441	
					BP.102			
					204 x 122 x 52 mm			
		0,60 Kg	0,55 Kg	0,66 Kg	0,82 Kg		0,83 Kg	

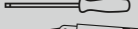

# 1/4" CLASSICAL-COMBINED SETS

## METRIC/INCH DIMENSIONS

		R.411MU	R.420MU
   1/4" 6,35 mm		R.151	RL.161
 mm		3,2 4 5 5,5 6 7 8 9 10 11 12 13 14	• • • • • • • • • • • •
 "		3/16 7/32 1/4 9/32 5/16 11/32 3/8 13/32 7/16 1/2 9/16	• • • • • • • • • •
 EH		3 4 5 6 7 8	• • • • • •
 ED		1 2 3	• • •
 ES		4,5 5,5 6,5 8	• • • •
 EXR		10 15 20 25 27 30 40	• • • • • • •
 R.209		•	•
 R.210		•	•
 R.215		•	•
 R.240A		•	•
 R.235		•	•
 R.236A		•	•
 R.120A		•	•
 R.222		•	•
 R.142		•	•
 PL.125A		PL.125A	PL.453
 BP.115		BP.115	BP.102
 332 x 143 x 67 mm		332 x 143 x 67 mm	204 x 122 x 52 mm
 1,56 Kg		1,56 Kg	0,72 Kg

R.411MU















R.420MU



# 1/4" CLASSICAL-COMBINED SETS

## METRIC/INCH/WRENCH DIMENSIONS

   1/4" 6,35 mm			R.440UP	R.418AU	R.450AP	R.440EP	R.447EP	R.430AP
			R.161	R.151	R.161	R.161	R.161	R.161
			mm+wrenches	mm	std+long	mm+wrenches	mm+wrenches	mm
 mm	3,2	3/16"	•	•	•	•	•	•
	4	7/32"	•	•	•	•	•	•
	5	1/4"	•	•	•	•	•	•
	5,5	9/32"	•	•	•	•	•	•
	6	5/16"	•	•	•	•	•	•
	7	11/32"	•	•	•	•	•	•
	8	3/8"	•	•	•	•	•	•
	9	13/32"	•	•	•	•	•	•
	10	7/16"	•	•	•	•	•	•
	11	1/2"	•	•	•	•	•	•
	12	9/16"	•	•	•	•	•	•
	13	-						
	14	-						
	 34 heads angled at 15° and 75°	3/2	3/16	•			•	
4		7/32	•			•		
5		1/4	•			•		
5,5		9/32	•			•		
6		5/16	•			•		
7		11/32	•			•		
8		3/8	•			•		
9		13/32	•			•		
10		7/16	•			•		
11		1/2	•			•		
12		9/16	•			•		
13								
14								
 ED		1			•		•	
	2			•		•		
	3					•		
	4					•		
 EH mm	2					•		
	2,5					•		
	3					•		
	4					•		
	5					•		
	6					•		
	7					•		
	8					•		
 ES	3			•		•		
	4			•		•		
	5,5			•		•		
	6,5			•		•		
 RT	3			•		•		
	4			•		•		
	5			•		•		
	7			•		•		
 22	3,2 x 5,5						•	
	4 x 5						•	
	6 x 7						•	
	8 x 9						•	
	10 x 11						•	
 R.209 R.210S R.215 R.240A R.235 R.245 R.236A R.120A R.110 R.140A R.216 R.227 181.18G AN 2,5 x 75 AN 3,5 x 75			•		•	•	•	•
			•	•	•	•	•	•
			•	•	•	•	•	•
			•	•	•	•	•	•
			•	•	•	•	•	•
			•	•	•	•	•	•
			•	•	•	•	•	•
			•	•	•	•	•	•
			•	•	•	•	•	•
			•	•	•	•	•	•
			•	•	•	•	•	•
			•	•	•	•	•	•
			•	•	•	•	•	•
			•	•	•	•	•	•
 PL.37A BP.109		PL.391B BP.102	PL.703	PL.36A	PL.128A	PL.414		
	478x234x72 mm	204x122x52 mm		478x234x72 mm		389x164x72 mm		
		2,56 Kg	0,55 Kg	3,26 Kg	2,70 Kg	2,50 Kg	1,92 Kg	

R.440UP ▼



R.418AU ▼



R.450AP ▼



R.440EP ▼



R.447EP ▼





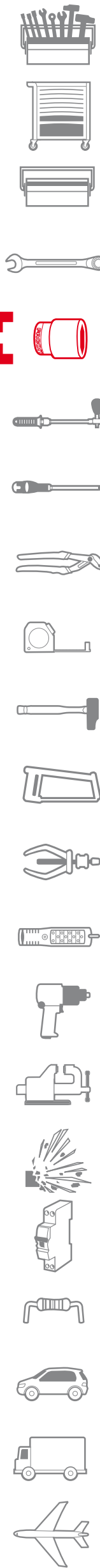









R.430AP ▼





# 1/4" SOCKETS SETS

## SET OR RACK

		R.40E	RL.40E	RL.41E	R.40U	REL.40U	RTX.40
 TORX®							TORX®
 1/4" 6,35 mm		Standard	Long	Long	Standard	Long	TORX®
 mm	3,2	•	•				
	4	•	•				
	5	•	•				
	5,5	•	•				
	6	•	•				
	7	•	•				
	8	•	•				
	9	•	•				
	10	•		•			
	11	•		•			
	12	•		•			
	13	•		•			
	14	•		•			
	 "	3/16				•	•
7/32					•	•	
1/4					•	•	
9/32					•	•	
5/16					•	•	
11/32					•	•	
3/8					•	•	
13/32					•	•	
7/16					•	•	
1/2					•	•	
9/16					•	•	
 TORX®	E4						•
	E5						•
	E6						•
	E7						•
	E8						•
	E10						•
		CKS.93	CKS.89	CKS.89	CKS.93	CKS.93	CKS.89
		0,255 Kg	0,220 Kg	0,310 Kg	0,235 Kg	0,345 Kg	0,090 Kg

R.40E  
RL.40E



RL.41E



R.40U



REL.40U



RTX.40



# 1/4" MODULES IN THERMOFORMED TRAYS

## METRIC/INCH

		1/4" 6,35 mm		MOD.RL1	MOD.R1	MOD.R5	MOD.R3
				RL.161	R.161	R.161	R.161
				6 mm	6 mm	6 mm	6"
	mm	3,2	3/16"				
		4	7/32"				
		5	1/4"				
		5,5	9/32"	•	•	•	•
		6	5/16"	•	•	•	•
		7	11/32"	•	•	•	•
		8	3/8"	•	•	•	•
		9	13/32"	•	•	•	•
		10	7/16"	•	•	•	•
		11	1/2"	•	•	•	•
		12	-	•	•	•	•
		13	-	•	•	•	•
		14	-	•	•	•	•
			EP	1			
2							
3							
	EH	1/8					•
		3/16					•
		5/32					•
	"	7/32					•
		3		•	•	•	
		4		•	•	•	
	mm	5		•	•	•	
		6		•	•	•	
		7		•	•	•	
	ED	ED.101T		•	•	•	
		ED.102T		•	•	•	
	ES	4,5		•	•	•	
		6,5		•	•	•	
		8		•	•	•	
	EXR	10				•	
		15				•	
		20				•	
		25				•	
		30				•	
		40				•	
	82H	2	5/64"	•	•	•	•
		2,5	3/32"	•	•	•	•
		3	1/8"	•	•	•	•
		4	9/64"	•	•	•	•
		5	5/32"	•	•	•	•
		6	3/16"	•	•	•	•
		7	7/32"	•	•	•	•
		8	1/4"	•	•	•	•
		9	5/16"	•	•	•	•
		10	3/8"	•	•	•	•
	83SH	1,5				•	
		2				•	
		2,5				•	
		3				•	
		4				•	
		5				•	
		6				•	
8				•			
	89S	10				•	
		15				•	
		20				•	
		25				•	
		27				•	
		30				•	
		45				•	
	R.209		•	•	•	•	
	R.215		•	•	•	•	
	R.240A		•	•	•	•	
	R.235		•	•	•	•	
	R.236A		•	•	•	•	
	R.120A		•	•	•	•	
		PL.321	PL.321	PL.658	PL.603		
		435 x 198 x 55 mm	420 x 180 x 55 mm	420 x 190 x 55 mm	420 x 180 x 55 mm		
			1,1 Kg	1,41 Kg	0,95 Kg		

MOD.RL1



MOD.R1



MOD.R5





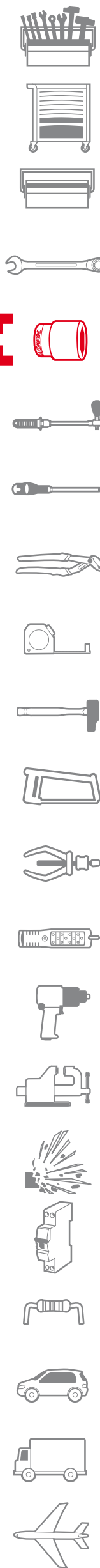













MOD.R3

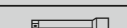
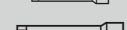

# 1/4" MODULES IN FOAM TRAYS

## BI-COLOURED-METRIC

		MODM.RL1	MODM.R1A	
		RL.161	R.161	
		6	6	
 1/4" 6,35 mm		1/4"	1/4"	
 mm	5,5	•	•	
	6	•	•	
	7	•	•	
	8	•	•	
	9	•	•	
	10	•	•	
	11	•	•	
	12	•	•	
 EP	EP.101T	•	•	
	EP.102T	•	•	
	EP.103T	•	•	
	 EH	EH.103	•	•
		EH.104	•	•
		EH.105	•	•
		EH.106	•	•
EH.107	•	•		
 ED	ED.101T	•	•	
	ED.102T	•	•	
	ED.103T	•	•	
 ES	ES.134,5T	•	•	
	ES.136,5T	•	•	
	ES.148T	•	•	
 EXR	EXR.115	•	•	
	EXR.120	•	•	
	EXR.125	•	•	
	EXR.127	•	•	
	EXR.130	•	•	
	EXR.140	•	•	
 83SH	1,5	•	•	
	2	•	•	
	2,5	•	•	
	3	•	•	
	4	•	•	
	5	•	•	
	6	•	•	
	8	•	•	
	10	•	•	
	 R.209  R.215  R.240A  R.235  R.236A  R.120A	R.209	•	•
R.215		•	•	
R.240A		•	•	
R.235		•	•	
R.236A		•	•	
R.120A		•	•	
		PM.MODR1A	PM.MODR1A	
		416 x 190 x 50 mm	420 x 190 x 55 mm	
		1,095 Kg		

MODM.RL1



MODM.R1A

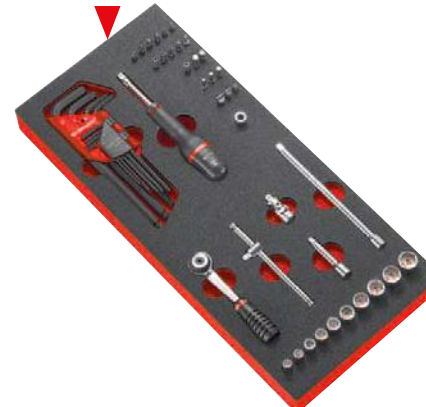

Ratchets 1/4"

1/4" maintenance free pear head ratchet

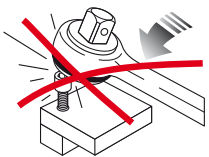
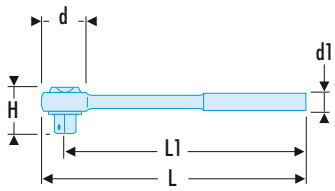

NF ISO 3315, ISO 3315, DIN 3122, ASME B107.10

- Dust proof, maintenance free mechanism.
- 72 teeth mechanism for 5° increments.
- Drive direction switch allows easy reversal even with gloved or greasy hands.
- Palm control system - allows the operator to press down on the head avoiding risk of accidental reverse.
- Ultra-compact head.
- Hook for hanging when working at height.
- Ergonomic comfort grip handle design resistant to workshop chemicals and solvents.

➤	d [mm]	d1 [mm]	H [mm]	L [mm]	L1 [mm]	ΔΔ [g]
<b>RL.161</b>	22	20	25	120	110	78

1/4" fast action twist handle ratchet

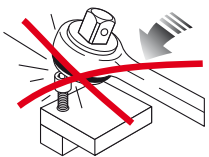
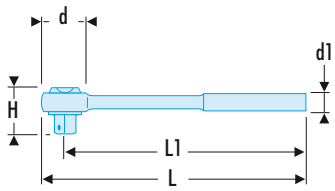

NF ISO 3315, ISO 3315, DIN 3122, ASME B107.10

- Rotating handle jack: work twice as fast in confined spaces.
- 6° increments for final tightening.
- Socket safety locking: no more lost sockets.
- Palm control system - allows the operator to press down on the head avoiding risk of accidental reverse.

➤	d [mm]	d1 [mm]	H [mm]	L [mm]	L1 [mm]	ΔΔ [g]
<b>R.360</b>	27	21	29	120	120	144

1/4" palm control ratchet

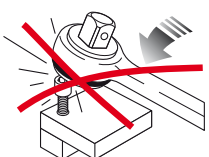
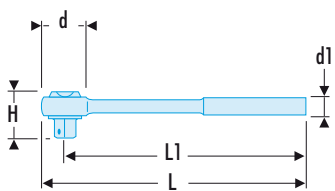

NF ISO 3315, ISO 3315, DIN 3122, ASME B107.10

- 72 teeth mechanism for 5° increments.
- Palm control system - allows the operator to press down on the head avoiding risk of accidental reverse.
- Ring reversing.

➤	d [mm]	d1 [mm]	H [mm]	L [mm]	L1 [mm]	ΔΔ [g]
<b>R.161</b>	25	19	25	120	108	120

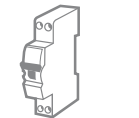
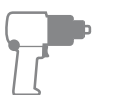
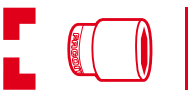

# "Radio" 1/4" range

## 1/4" standard ratchet

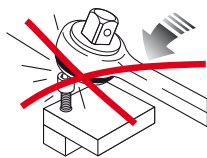
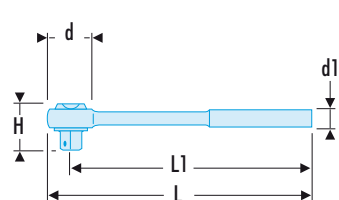

NF ISO 3315, ISO 3315, DIN 3122, ASME B107.10

- 72 teeth mechanism for 5° increments.
- Reverse by rotating cap.

➤	d [mm]	d1 [mm]	H [mm]	L [mm]	L1 [mm]	ΔΔ [g]
<b>R.151</b>	25	21	25	120	108	100

## Ultra compact 1/4" bit ratchet

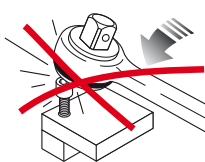
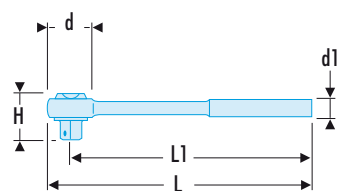

- Exceptionally compact design when using end bits.
- Mechanism: 60 teeth.
- Use sockets with the ECR adapter.
- Supplied with magnetic extension.

➤	d [mm]	d1 [mm]	H [mm]	L [mm]	L1 [mm]	ΔΔ [g]
<b>R.PE</b>	17	16	26,5	158	126	96

## 65.PE Bit-holder ratchet wrench 1/4" - 5/16"



- Takes the following bits:
    - Series 1: hexagon 1/4".
    - Series 2: hexagon 5/16".
  - Used for installing 1/4" and 5/16" aircraft fasteners.
  - Increment: 5°.
  - Heads angled at 15°.
  - Bits held by a spring clip.
  - Knurled head for fast pre-tightening.
  - Length 150 mm.
  - Satin chrome finish.
- Weight: 74 g.

## 1/4" finger control ratchet

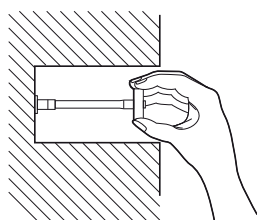
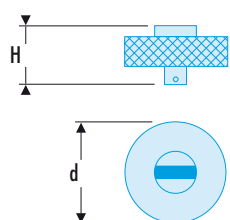

- 72 teeth mechanism for 5° increments.
  - Ideal for confined deep recess spaces.
- Weight: 120 g.

➤	d [mm]	H [mm]	ΔΔ [g]
<b>R.150A</b>	38,5	26,5	95

1/4" long hinged metal grip ratchet

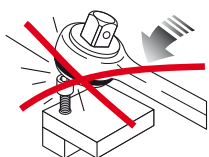
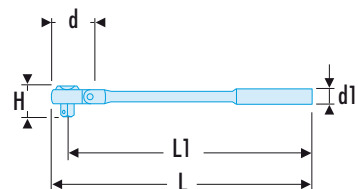

- 72 teeth mechanism for 5° increments.
- Palm control system - allows the operator to press down on the head avoiding risk of accidental reverse.
- Stiffened joint to maintain the position even with an extension and the socket engaged.
- Knurled metal grip.

➤	d [mm]	d1 [mm]	H [mm]	L [mm]	L1 [mm]	ΔΔ [g]
<b>R.158A</b>	25	11	26,5	158	126	135

MAINTENANCE OF 1/4" RATCHETS

➤	R.161	R.151	R.155A	R.157A	R.158A	R.150A
<b>Caps</b>						
<b>R.161C</b>	•		•	•	•	
<b>J.161C</b>						•
<b>R.151C</b>		•				
<b>Spare part kit</b>						
<b>R.161RN</b>	•		•	•	•	•
<b>R.151RN</b>		•				
<b>Rotors</b>						
<b>R.151R</b>	•	•	•	•	•	•

Accessories 1/4"

1/4" drive sliding tee

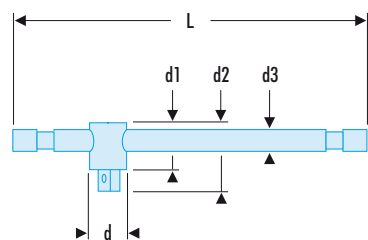

NF ISO 3315, ISO 3315, DIN 3122, ASME B107.10

- Friction bar allows the bar to form a T or L-handle.
- Finish: bright chrome.

➤	d [mm]	d1 [mm]	d2 [mm]	d3 [mm]	L [mm]	ΔΔ [g]
<b>R.120A</b>	12	14	22	7	115	49

1/4" hinged handle

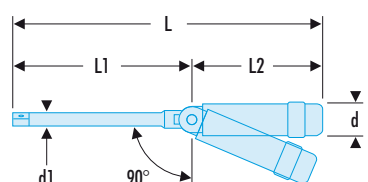

- Driver or L-handle for fast approach or powerful locking.

➤	d [mm]	d1 [mm]	L [mm]	L1 [mm]	L2 [mm]	ΔΔ [g]
<b>R.142</b>	14	8,1	182	105	77	125

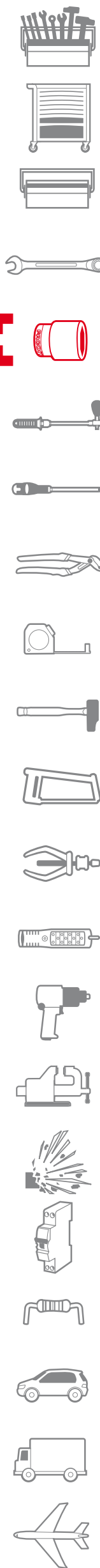

# "Radio" 1/4" range

## ▣ Hinged bar 1/4" with handle

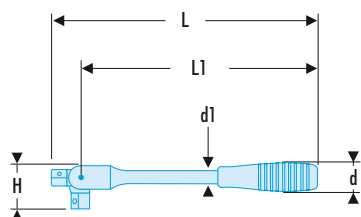

NF ISO 3315, ISO 3315, DIN 3122, ASME B107.10

- Spring steadies hinge in any position, allowing access behind obstacles.
- Non-slip handle.
- Finish: bright chrome.

	d [mm]	d1 [mm]	H [mm]	L [mm]	L1 [mm]	$\Delta\Delta$ [g]
<b>R.140A</b>	19	8	25,5	150	131,5	83

## ▣ R.236C 1/4" drive short spinner



NF ISO 3315, ISO 3315, DIN 3122, ASME B107.10

- Ergonomic bi-material grip.
  - Ideal for confined spaces.
- Weight: 76 g.

## ▣ R.236A 1/4" drive medium spinner



NF ISO 3315, ISO 3315, DIN 3122, ASME B107.10

- Ergonomic bi-material grip.
  - Ideal for confined spaces.
- Weight: 79 g.

## ▣ 1/4" drive standard spinner

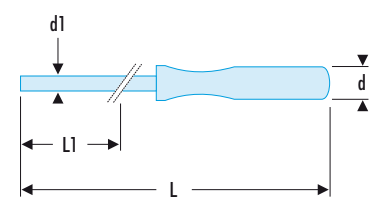

NF ISO 3315, ISO 3315, DIN 3122, ASME B107.10

- Ergonomic bi-material grip.
- Ideal for confined spaces.

	d [mm]	d1 [mm]	L [mm]	L1 [mm]	$\Delta\Delta$ [g]
<b>R.227A</b>	23,5	8	260	160	125

## ▣ 1/4" drive flexible spinner

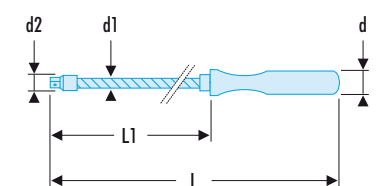

- Ergonomic bi-material grip.
- For fasteners where access is difficult.

	d [mm]	d1 [mm]	d2 [mm]	L [mm]	L1 [mm]	$\Delta\Delta$ [g]
<b>R.222A</b>	20	8	12	265	160	117

1/4" drive speed brace

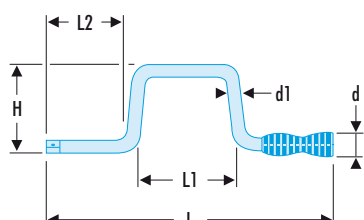

NF ISO 3315, ISO 3315, DIN 3122, ASME B107.10

- For fast rotation.
- PVC rotating handle.
- Finish: bright chrome.

➤	d [mm]	d1 [mm]	H [mm]	L [mm]	L1 [mm]	L2 [mm]	ΔΔ [g]
<b>R.110</b>	21	8	110	360	130	120	220

1/4" drive extension

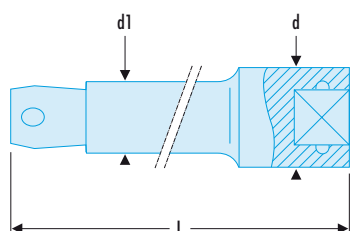

NF ISO 3316, ISO 3316, DIN 3123, ASME B107.10

- Finish: chromed.

➤	d [mm]	d1 [mm]	L [mm]	ΔΔ [g]
<b>R.209</b>	12	8,2	55	30
<b>R.210</b>	12	8,2	100	45
<b>R.215</b>	12	8,2	150	65
<b>R.217</b>	12	8,2	250	105

WOBBLE EXTENSION

Hard to access with a socket or universal joint? USE A WOBBLE EXTENSION !

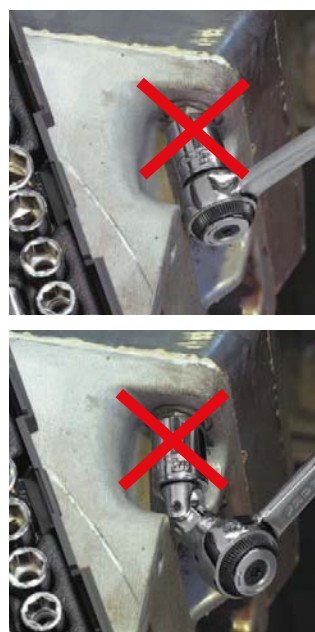
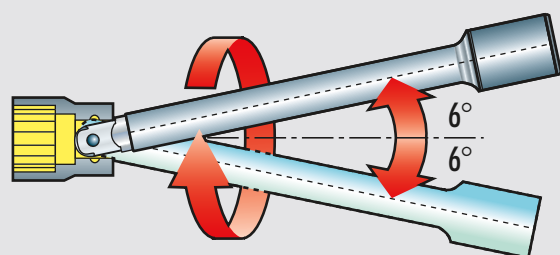



# "Radio" 1/4" range

## 1/4" wobble extension

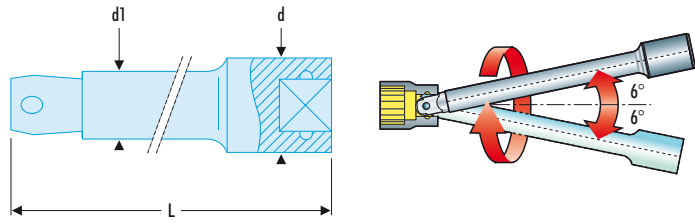

- Square drive profile gives 6° working angle.
- Hard to access with a socket or universal joint? Use a wobble extension !
- Finish: bright chrome.

🔧	d [mm]	d1 [mm]	L [mm]	ΔΔ [g]
<b>R.209S</b>	12	8,2	55	30
<b>R.210S</b>	12	8,2	100	45

## 1/4" drive locking extensions

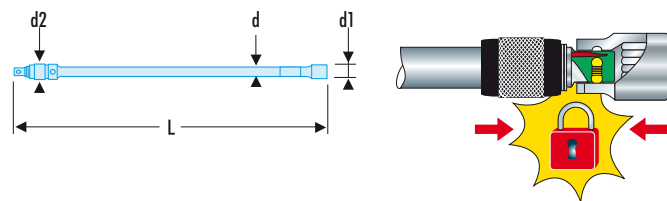

NF ISO 3316, ISO 3316, DIN 3123, ASME B107.10

- Locking mechanism.
- Finish: bright chrome.

🔧	d [mm]	d1 [mm]	d2 [mm]	L [mm]	ΔΔ [g]
<b>R.210RC</b>	8,2	12	13	100	45
<b>R.215RC</b>	8,2	12	13	150	60
<b>R.217RC</b>	8,2	12	13	250	100

## 1/4" wobble extension

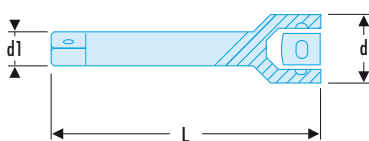

ASME B107.10

- Reaches fasteners out of direct access line.
- Unsuitable for high torques: max. 2.8 N.m.

🔧	d [mm]	d1 [mm]	L [mm]	ΔΔ [g]
<b>R.216</b>	12	8	150	66

## 1/4" drive tee with universal joint

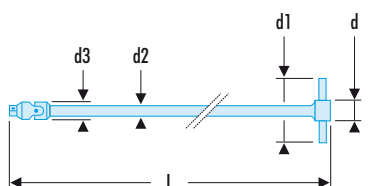
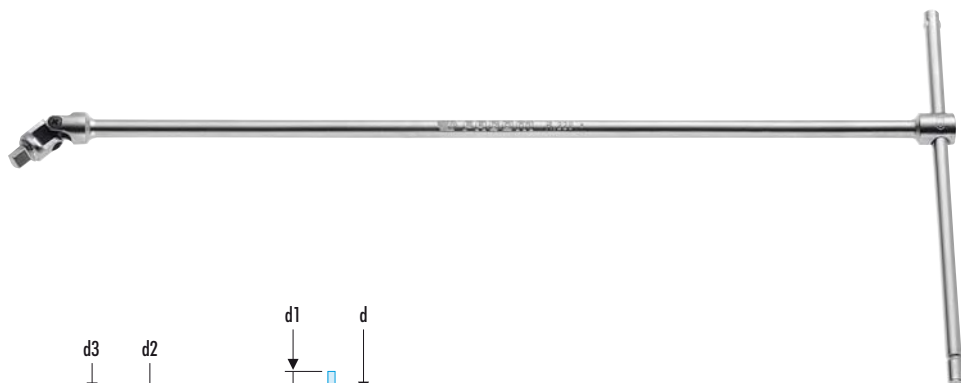

- Universal joint withstands high torques and is spring-steadied in position.
- Long reach and working angle up to 65° allows access to recessed fasteners.
- Finish: bright chrome.

🔧	d [mm]	d1 [mm]	d2 [mm]	d3 [mm]	L [mm]	ΔΔ [g]
<b>R.229A</b>	13	135	9	13	385	215

1/4" drive tee with universal joint

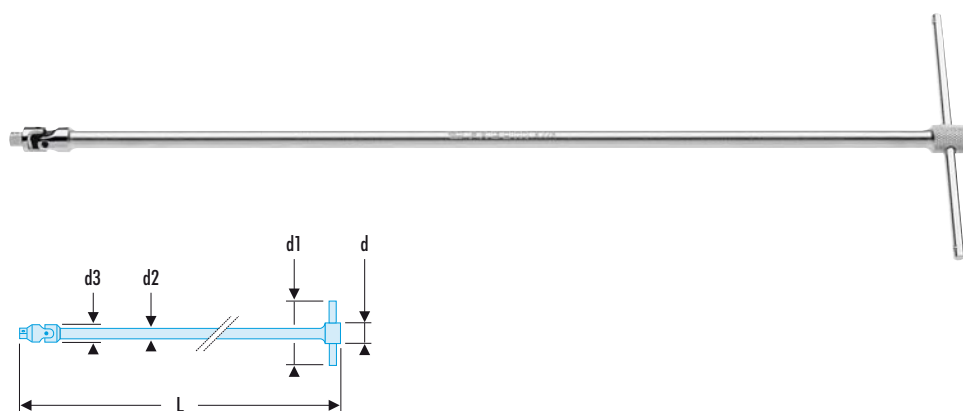

- Extended reach of tee-handle for particularly deep recesses.
- Finish: bright chrome.

➤	d [mm]	d1 [mm]	d2 [mm]	d3 [mm]	L [mm]	ΔΔ [g]
<b>R.228</b>	13	135	9	13	470	250

1/4" universal joint

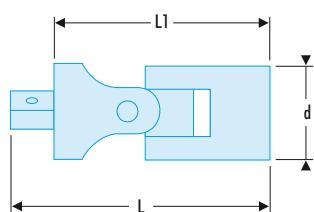

NF ISO 3316, ISO 3316, DIN 3123, ASME B107.10

- Spring-stiffened joints. Stays in position when reaching for fasteners.
- Finish: bright chrome.

➤	d [mm]	L [mm]	L1 [mm]	ΔΔ [g]
<b>R.240A</b>	13	33	25	20

1/4" to 3/8" coupler

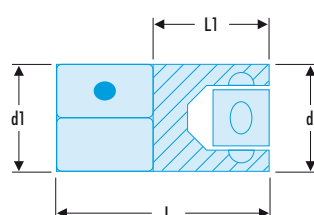

NF ISO 3316, ISO 3316, DIN 3123, ASME B107.10

- 1/4" female to 3/8" male square drive.
- For adapting 3/8" drive sockets.
- Finish: bright chrome.

➤	d [mm]	d1 [mm]	L [mm]	L1 [mm]	ΔΔ [g]
<b>R.232</b>	12	12	24,5	13,5	16

D.169 Set of 3 couplers



- Allows use of square drivers smaller than socket drive sizes:
  - 1/4" square drive + D.169RJ --> 3/8" socket.
  - 3/8" square drive + D.169JS --> 1/2" socket.
  - 1/2" square drive --> 3/4" socket.
- Compactness means that fewer tools are needed for in situ maintenance operations.
- Magnetic retainer and locking system (JS and SK).
- Knurl allows hand tightening where access is difficult.
- Weight: 96 g.

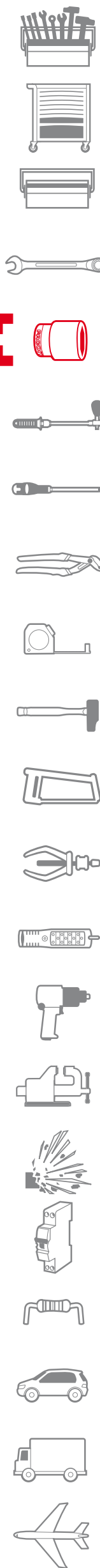

# "Radio" 1/4" range

## 1/4" drive standard spring-clip bit holder

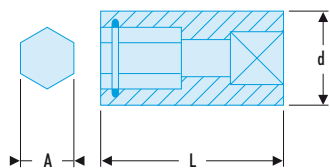

NF ISO 2725-1, NF ISO 1173, ISO 2725-1, ISO 1173, DIN 3124

- Spring clip for frequent bit changes.
- Finish: bright chrome.

☞	A ["]	Square ["]	d [mm]	L [mm]	ΔΔ [g]
<b>R.235</b>	1/4	1/4	11,3	22	10

## 1/4" drive secure spring-clip bit holder

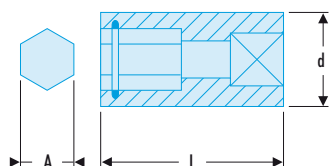

NF ISO 2725-1, NF ISO 1173, ISO 2725-1, ISO 1173, DIN 3124

- Stiffer, more secure, spring clip for infrequent bit changes.
- Square drive has side-hole for ball or plunger lock.
- Finish: bright chrome.

☞	A ["]	Square ["]	d [mm]	L [mm]	ΔΔ [g]
<b>R.245</b>	1/4	1/4	11,3	22	10

## 1/4" drive lock-ring bit holder



NF ISO 2725-1, NF ISO 1173, ISO 2725-1, ISO 1173, DIN 3124

- Bit lock.
- Square drive has side-hole for ball or plunger lock.

☞	A ["]	Square ["]	L [mm]	ΔΔ [g]
<b>EFR</b>	1/4	1/4	30	26

## Sockets 1/4"

### R 1/4" drive metric 6-point sockets

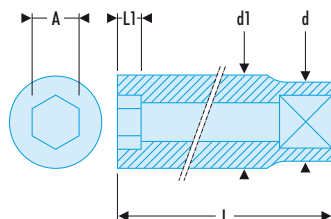

NF ISO 2725-1, NF ISO 1711-1, ISO 2725-1, ISO 1711-1, DIN 3124, ASME B107.5

- OGV® profile: more powerful tightening, preserves fasteners.
- Finish: bright chrome.
- Available as sets on metal rack (Ref R.40E).

☞	A [mm]	⊙ [mm]	d [mm]	d1 [mm]	L [mm]	L1 [mm]	ΔΔ [g]
<b>R.3,2</b>	3,2	6	11,2	5,9	22	2,4	7,30
<b>R.4</b>	4,0	6	11,2	6,9	22	2,6	7,70
<b>R.5</b>	5,0	6	11,2	8,2	22	4,8	8,10
<b>R.5,5</b>	5,5	6	11,2	8,8	22	4,8	8,40
<b>R.6</b>	6,0	6	11,2	9,4	22	5,6	8,60
<b>R.7</b>	7,0	6	11,0	11,0	22	6,0	9,20
<b>R.8</b>	8,0	6	12,0	12,0	22	6,5	11,50
<b>R.9</b>	9,0	6	13,2	13,2	22	6,5	14,30
<b>R.10</b>	10,0	6	14,7	14,7	22	7,8	17,70
<b>R.11</b>	11,0	6	15,8	15,8	22	9,0	19,40
<b>R.12</b>	12,0	6	17,0	17,0	22	9,50	23,20
<b>R.13</b>	13,0	6	17,7	17,7	22	10,00	23,70
<b>R.14</b>	14,0	6	18,7	18,7	22	10,00	26,10

### R 1/4" drive inch 6-point sockets

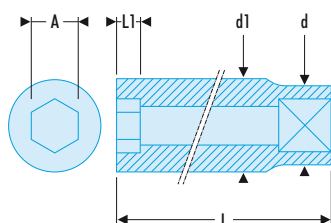

#### ASME B107.1

- OGV® profile: more powerful tightening, preserves fasteners.
- Finish: bright chrome.
- Available as rack set (Ref R.40U).

Ref	A ["]	⌀ [mm]	d [mm]	d1 [mm]	L [mm]	L1 [mm]	ΔΔ [g]
R.3/16	3/16	6	11,2	8,0	22	4,75	8,20
R.7/32	7/32	6	11,2	9,0	22	5,50	8,30
R.1/4	1/4	6	11,2	10,1	22	6,00	9,30
R.9/32	9/32	6	11,0	11,0	22	6,00	8,90
R.5/16	5/16	6	12,0	12,0	22	6,50	11,50
R.11/32	11/32	6	13,2	13,2	22	6,50	14,50
R.3/8	3/8	6	14,7	14,7	22	7,80	17,80
R.13/32	13/32	6	14,7	14,7	22	7,80	17,00
R.7/16	7/16	6	15,8	15,8	22	9,00	19,50
R.1/2	1/2	6	17,7	17,7	22	10,00	24,50
R.9/16	9/16	6	18,7	18,7	22	10,00	25,20

### R.E 1/4" drive metric 12-point sockets

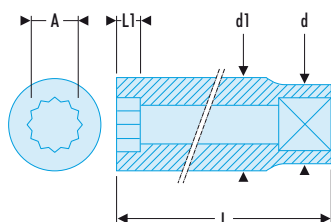

#### NF ISO 2725-1, NF ISO 1711-1, ISO 2725-1, ISO 1711-1, DIN 3124, ASME B107.5

- OGV® profile: more powerful tightening, preserves fasteners.
- Finish: bright chrome.

Ref	A [mm]	⌀ [mm]	d [mm]	d1 [mm]	L [mm]	L1 [mm]	ΔΔ [g]
R.5,5E	5,5	12	11,2	8,8	22	4,80	8,40
R.6E	6,0	12	11,2	9,4	22	5,60	8,60
R.7E	7,0	12	11,0	11,0	22	6,00	9,20
R.8E	8,0	12	12,0	12,0	22	6,50	11,50
R.9E	9,0	12	13,2	13,2	22	6,50	14,30
R.10E	10,0	12	14,7	14,7	22	7,80	17,70
R.11E	11,0	12	15,8	15,8	22	9,00	19,40
R.12E	12,0	12	17,0	17,0	22	9,50	23,20
R.13E	13,0	12	17,7	17,7	22	10,00	23,70
R.14E	14,0	12	18,7	18,7	22	10,00	26,10

### R.E 1/4" drive inch 12-point sockets

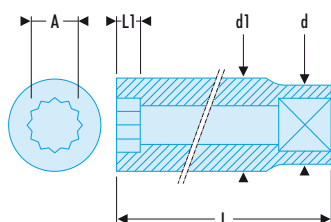

#### ASME B107.1

- OGV® profile: more powerful tightening, preserves fasteners.
- Finish: bright chrome.

Ref	A ["]	⌀ [mm]	d [mm]	d1 [mm]	L [mm]	L1 [mm]	ΔΔ [g]
R.3/16E	3/16	12	11,2	8,0	22	4,75	8,20
R.7/32E	7/32	12	11,2	9,0	22	5,50	8,30
R.1/4E	1/4	12	11,2	10,1	22	6,00	9,30
R.9/32E	9/32	12	11,2	10,6	22	6,00	8,90
R.5/16E	5/16	12	12,0	12,0	22	6,50	11,50
R.11/32E	11/32	12	13,0	13,0	22	6,50	14,50
R.3/8E	3/8	12	14,7	14,7	22	7,80	17,80
R.13/32E	13/32	12	14,7	14,7	22	7,80	17,00
R.7/16E	7/16	12	15,8	15,8	22	9,00	19,5
R.1/2E	1/2	12	17,7	17,7	22	10,00	24,5
R.9/16E	9/16	12	18,7	18,7	22	10,00	25,20

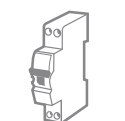

# "Radio" 1/4" range

## RB 1/4" drive inch 12-point thin wall sockets

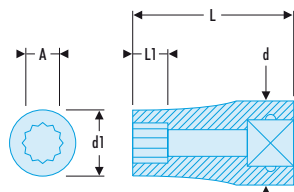

### ASME B107-1

- OGV® profile: more powerful tightening, preserves fasteners.
- Thin-wall for better access, conform with aeronautical standards.
- Finish: bright chrome.

➤	A ["]	⚙ [mm]	d [mm]	d1 [mm]	L [mm]	L1 [mm]	ΔΔ [g]
<b>RB.3/16</b>	3/16	12	11,2	7,6	22	4,8	7,00
<b>RB.7/32</b>	7/32	12	11,2	8,7	22	5,5	8,00
<b>RB.1/4</b>	1/4	12	11,2	9,7	22	6,0	8,00
<b>RB.9/32</b>	9/32	12	11,2	10,6	22	6,0	10,50
<b>RB.5/16</b>	5/16	12	11,9	11,9	22	6,5	10,00
<b>RB.11/32</b>	11/32	12	12,9	12,9	22	6,5	11,50
<b>RB.3/8</b>	3/8	12	13,7	13,7	22	7,8	14,00
<b>RB.7/16</b>	7/16	12	14,8	15,8	22	9,0	17,00
<b>RB.1/2</b>	1/2	12	16,0	16,9	22	10,0	18,50
<b>RB.9/16</b>	9/16	12	17,5	18,7	22	10,0	22,00

## Long reach sockets 1/4"

### R.LA 1/4" long-reach metric 6-point sockets

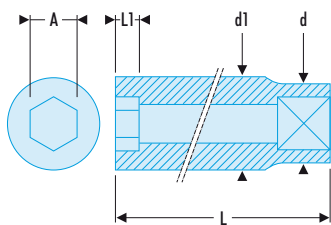

### NF ISO 2725-1, NF ISO 1711-1, ISO 2725-1, ISO 1711-1, DIN 3124, ASME B107.5

- OGV® profile: more powerful tightening, preserves fasteners.
- Long-reach sockets for long recess or thread access.
- Available as rack set Ref RL.40E (3.2 --> 9 mm) and Ref RL.41E (10 --> 14 mm).
- Finish: bright chrome.

➤	A [mm]	⚙ [mm]	d [mm]	d1 [mm]	L [mm]	L1 [mm]	ΔΔ [g]
<b>R.3,2LA</b>	3,2	6	12,0	5,80	50,5	1,8	18
<b>R.4LA</b>	4,0	6	12,0	6,80	50,5	2,0	18
<b>R.5LA</b>	5,0	6	12,0	8,10	50,5	2,3	18
<b>R.5,5LA</b>	5,5	6	12,0	8,10	50,5	3,0	18
<b>R.6LA</b>	6,0	6	12,0	9,40	50,5	5,6	18
<b>R.7LA</b>	7,0	6	12,0	10,90	50,5	7,1	27
<b>R.8LA</b>	8,0	6	12,0	12,00	50,5	7,9	27
<b>R.9LA</b>	9,0	6	12,8	12,80	50,5	7,9	32
<b>R.10LA</b>	10,0	6	14,3	14,30	50,5	7,9	41
<b>R.11LA</b>	11,0	6	16,0	16,00	50,5	7,9	54
<b>R.12LA</b>	12,0	6	16,8	16,80	50,5	8,4	50
<b>R.13LA</b>	13,0	6	18,2	18,20	50,5	8,4	59
<b>R.14LA</b>	14,0	6	19,2	19,20	50,5	10,2	68

### R.EL 1/4" long-reach metric 12-point sockets

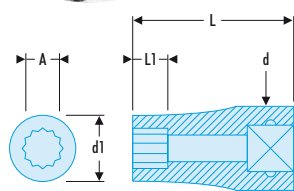

### ASME B107.1

- OGV® profile: more powerful tightening, preserves fasteners.
- Long-reach sockets for long recess or thread access.
- High performance, suitable for aircraft fasteners to AS954E.
- Thinner socket walls for better accessibility.
- Available as rack set (Ref REL.40U).
- Finish: bright chrome.

➤	A ["]	⚙ [mm]	d [mm]	d1 [mm]	L [mm]	L1 [mm]	ΔΔ [g]
<b>R.3/16EL</b>	3/16	12	10,9	7,7	50	6,0	14
<b>R.7/32EL</b>	7/32	12	10,9	8,5	50	7,4	15
<b>R.1/4EL</b>	1/4	12	10,9	9,4	50	7,4	17
<b>R.9/32EL</b>	9/32	12	10,9	10,2	50	8,5	17
<b>R.5/16EL</b>	5/16	12	11,8	11,4	50	9,0	23
<b>R.11/32EL</b>	11/32	12	12,0	12,5	50	9,7	25
<b>R.3/8EL</b>	3/8	12	12,8	13,7	50	11,2	32
<b>R.7/16EL</b>	7/16	12	14,3	15,6	50	11,9	40
<b>R.1/2EL</b>	1/2	12	16,2	17,3	50	13,8	45
<b>R.9/16EL</b>	9/16	12	17,1	18,8	50	16,2	49

### ▣ R.F - 1/4" drive hinged 12-point sockets

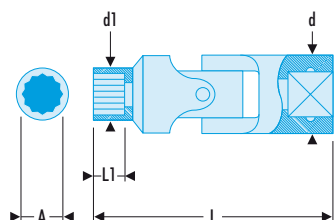

#### ASME B107.1

- OGV® profile: more powerful tightening, preserves fasteners.
- Compact solution used instead of universal joint.
- Finish: bright chrome.

➤	⚙ [mm]	d [mm]	d1 [mm]	L [mm]	L1 [mm]	ΔΔ [g]
<b>R.3/16F</b>	12	13	8,0	31,6	5,3	13
<b>R.7/32F</b>	12	13	8,5	32,4	6,1	13
<b>R.1/4F</b>	12	13	9,8	32,8	6,5	13
<b>R.9/32F</b>	12	13	10,5	32,8	6,5	13
<b>R.5/16F</b>	12	13	12,0	33,3	7,0	14
<b>R.11/32F</b>	12	13	13,3	33,3	7,0	16
<b>R.3/8F</b>	12	13	13,7	34,6	8,3	21
<b>R.7/16F</b>	12	13	15,5	35,8	9,5	27
<b>R.1/2F</b>	12	13	18,0	36,8	10,5	34
<b>R.9/16F</b>	12	13	19,2	36,8	10,5	35

### Torx® sockets 1/4"

#### ▣ RTX - 1/4" Torx® sockets

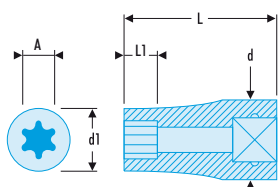

- For Torx® fasteners.
- Finish: bright chrome.
- Available as rack set (Ref RTX.40).

➤	A [mm]	Torx [No]	d [mm]	d1 [mm]	L [mm]	L1 [mm]	ΔΔ [g]
<b>RTX.4</b>	3,70	E4	11,2	5,4	22	3,2	8
<b>RTX.5</b>	4,58	E5	11,2	6,7	22	3,0	8
<b>RTX.6</b>	5,54	E6	11,2	7,7	22	3,6	8
<b>RTX.7</b>	6,22	E7	11,2	8,3	22	3,6	8
<b>RTX.8</b>	7,29	E8	11,2	9,6	22	4,3	9
<b>RTX.10</b>	9,19	E10	12,0	11,3	22	5,6	11

### 1/4" drive sockets with removable bits

#### ▣ RT 1/4" drive metric 6-point sockets

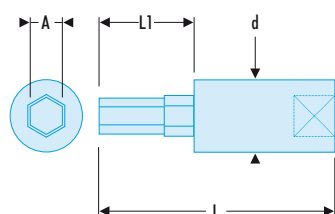

- Removable hard tip for more durability.
- R.245 socket.
- Finish: bright chrome with phosphate-hardened tip.

➤	A [mm]	d [mm]	Bits	L [mm]	L1 [mm]	ΔΔ [g]
<b>RT.2</b>	2,0	11,3	EH.102	37	15	18
<b>RT.2,5</b>	2,5	11,3	EH.102,5	37	15	18
<b>RT.3</b>	3,0	11,3	EH.103	37	15	18
<b>RT.4</b>	4,0	11,3	EH.104	37	15	18
<b>RT.5</b>	5,0	11,3	EH.105	37	15	19
<b>RT.6</b>	6,0	11,3	EH.106	37	15	20
<b>RT.7</b>	7,0	11,3	EH.107	37	15	21
<b>RT.8</b>	8,0	11,3	EH.108	37	15	22
<b>RT.10</b>	10,0	11,3	EH.110	37	15	24

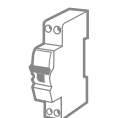

# "Radio" 1/4" range

## RT 1/4" drive metric 6-point sockets

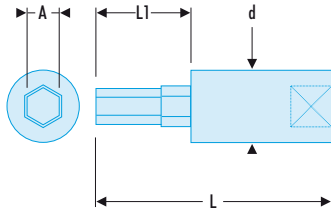

- Removable hard tip for more durability.
- R.245 socket.
- Finish: bright chrome with phosphate-hardened tip.

➤	A [mm]	d [mm]	Bits	L [mm]	L1 [mm]	ΔΔ [g]
<b>RT.1/8</b>	3,17	11,3	EH.101/8	37	15	18
<b>RT.5/32</b>	3,96	11,3	EH.105/32	37	15	18
<b>RT.3/16</b>	4,76	11,3	EH.103/16	37	15	18
<b>RT.7/32</b>	5,56	11,3	EH.107/32	37	15	19
<b>RT.1/4</b>	6,35	11,3	EH.101/4	37	15	20

## RX 1/4" drive Torx® bit sockets

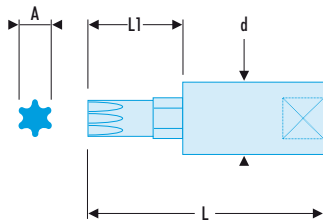

- Removable hard tip for more durability.
- R.245 socket.
- Finish: bright chrome with phosphate-hardened tip.

➤	A [mm]	Torx [No]	d [mm]	Bits	L [mm]	L1 [mm]	ΔΔ [g]
<b>RX.6</b>	1,65	T6	11,3	EX.106	38	16	17
<b>RX.7</b>	1,97	T7	11,3	EX.107	38	16	17
<b>RX.8</b>	2,30	T8	11,3	EX.108	38	16	17
<b>RX.9</b>	2,48	T9	11,3	EX.109	38	16	17
<b>RX.10</b>	2,72	T10	11,3	EX.110	38	16	17
<b>RX.15</b>	3,26	T15	11,3	EX.115	38	16	17
<b>RX.20</b>	3,84	T20	11,3	EX.120	38	16	18
<b>RX.25</b>	4,40	T25	11,3	EX.125	38	16	18
<b>RX.27</b>	4,96	T27	11,3	EX.127	38	16	18
<b>RX.30</b>	5,49	T30	11,3	EX.130	38	16	18
<b>RX.40</b>	6,60	T40	11,3	EX.140	38	16	18

## CREATE YOUR OWN BIT SOCKETS

### Screw bits



- Series 1  $\square$  1/4"
- Series 2  $\square$  5/16"

➤ See Section 7 p. 450

### Bit holder $\square$ 1/4"



**R.235**  
 $\square$  1/4" 6.35 mm  
 standard retaining pin



**R.245**  
 $\square$  1/4" 6.35 mm  
 heavy duty retaining pin

➤ See p. 458



# 3/8" "DETECTION BOX" SETS

## METRIC DIMENSIONS

		JL.DBOX1	JL.DBOX112	J.360DBOX1	J.360DBOX112	J.DBOX500	J.DBOX501
		JL.161	JL.161	J.360	J.360	J.171	J.171
		6	12	6	12	6	12
	J.8	•	•	•	•	•	•
	J.9	•	•	•	•	•	•
	J.10	•	•	•	•	•	•
	J.11	•	•	•	•	•	•
	J.12	•	•	•	•	•	•
	J.13	•	•	•	•	•	•
	J.14	•	•	•	•	•	•
	J.15	•	•	•	•	•	•
	J.16	•	•	•	•	•	•
	J.17	•	•	•	•	•	•
	J.18	•	•	•	•	•	•
J.19	•	•	•	•	•	•	
J.21	•	•	•	•	•	•	
J.22	•	•	•	•	•	•	
	J.210	•	•	•	•		
	J.210RC					•	•
	J.215	•	•	•	•		
	J.210RC					•	•
	J.240A	•	•	•	•	•	•
BV.J1NANO							
50 x 124 x 280 mm							
		1,920 Kg	1,920 Kg	2,050 Kg	2,050 Kg	2,010 Kg	2,010 Kg



**JL.DBOX1**



**JL.DBOX112**



**J.360DBOX1**



**J.360DBOX112**



**J.DBOX500**





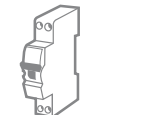
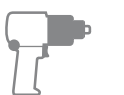
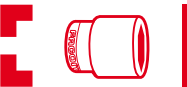



**J.DBOX501**



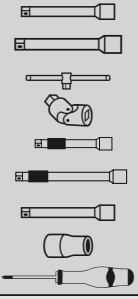

# STANDARD 3/8" SETS

## METRIC DIMENSIONS

		J.420E	J.430AP	J.431AP	J.431ASP	J.430ASP
		J.151A	J.161	J.161	J.161	J.161
		12	12	6	6	12
 mm	7	•				
	8	•	•	•	•	•
	9	•	•	•	•	•
	10	•	•	•	•	•
	11	•	•	•	•	•
	12	•	•	•	•	•
	13	•	•	•	•	•
	14	•	•	•	•	•
	15	•	•	•	•	•
	16	•	•	•	•	•
	17	•	•	•	•	•
	18	•	•	•	•	•
 ED  EH mm	1				•	•
	2				•	•
	3				•	•
	4					
	5				•	•
	6				•	•
	8				•	•
	10				•	•
 ES	6,5				•	•
	8				•	•
	10				•	•
	J.210		•	•	•	•
	J.215		•	•	•	•
	J.120A		•	•	•	•
	J.240A		•	•	•	•
	J.210RC					
	J.215RC					
	J.210S	•				
	J.235				•	•
J.236C				•	•	
	PL.19A	PL.412A		PL.411		
	BP.115	BP.112		BP.112		
	322 x 143 x 67 mm	389 x 164 x 66 mm		389 x 164 x 66 mm		
		1,50 Kg	1,96 Kg	2,75 Kg		

**J.420E ▼**



**J.430AP ▼**



**J.431AP ▼**







**J.430ASP ▼  
J.431ASP ▼**



# STANDARD 3/8" SETS

## METRIC DIMENSIONS

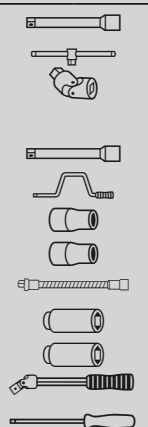
		J.451EP		J.426M	J.447E		JT.415E	JX.415EP
		J.161+J.156		-	J.151		J.151A	J.161
		6	12	6	12	wrench	6	TORX®
		Std	Long	Fittings	Std	39	Screwdriver socket	Screwdriver socket
 mm	7	•	•		•	•		
	8	•	•		•	•		
	9	•	•		•	•		
	10	•	•		•	•		
	11	•	•		•	•		
	12	•	•		•	•		
	13	•	•		•	•		
	14	•	•		•	•		
	15	•	•		•	•		
	16	•	•		•	•		
	17	•	•		•	•		
	18	•	•		•	•		
 JT mm	3	•					•	
	4	•					•	
	5	•					•	
	6	•					•	
	7	•					•	
	10	•					•	
 EP	1			•				
	2			•				
	3			•				
	4			•				
 ED	1	•		•				
	2	•		•				
	3	•		•				
 ES	4			•				
	5,5	•		•				
	6,5	•		•				
	8	•		•				
 TORX®	10			•				•
	15			•				•
	20			•				•
	25			•				•
	27			•				•
	30			•				•
	40			•				•
55			•				•	
 EH mm	3			•				
	4			•				
	5			•				
	6			•				
	7			•				
	10			•				
	J.210	•		•		•		
	J.120A	•		•				•
	J.240A	•		•		•		
	J.215R	•		•		•		•
	J.210S	•		•			•	
	J.110	•		•				
	J.235	•		•				•
	J.236	•		•				•
	J.216	•		•				
	BJ.21A1			•		•		
	BJ.16A1			•		•		
	J.140A	•		•				
J.222			•					
		PL.77A BT.105 540 x 280 x 58 mm 7,70 Kg	PL.20A BP.112 389 x 164 x 66 mm 2,53 Kg	PL.27B BP.109 478 x 234 x 72 mm 3,55 Kg	PL.20A BP.115 322 x 143 x 66 mm 1,27 Kg	PL.118 BT.109G 470 x 195 x 53 mm 1,75 Kg		

J.451EP



J.426M



J.447E



JT.415E





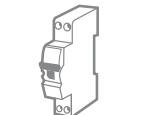





JX.415EP

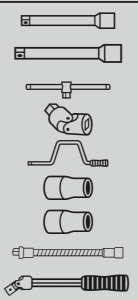

# 3/8" SETS IN A PLASTIC CASE

## INCH DIMENSIONS

		J.430MU	JL.430MU	J.430UP	J.450U	J.420AU	
		J.161	JL.161	J.161	J.151A+J.156	J.161	
		12	12	12	12	12	
		Standard	Standard	Standard	Std Long	Standard	
 mm	7	•	•				
	8	•	•				
	9	•	•				
	10	•	•				
	11	•	•				
	12	•	•				
	13	•	•				
	14	•	•				
	15	•	•				
	16	•	•				
	17	•	•				
	18	•	•				
	19	•	•				
	20	•	•				
	21	•	•				
	22	•	•				
24	•	•					
 "	1/4	•	•	•	•	•	
	5/16	•	•	•	•	•	
	3/8	•	•	•	•	•	
	7/16	•	•	•	•	•	
	1/2	•	•	•	•	•	
	9/16	•	•	•	•	•	
	5/8	•	•	•	•	•	
	11/16	•	•	•	•	•	
	3/4	•	•	•	•	•	
	13/16	•	•	•	•	•	
	7/8	•	•	•	•	•	
	15/16	•	•	•	•	•	
	1	•	•	•	•	•	
	 JT	1/8				•	
		5/32				•	
		3/16				•	
mm		7/32				•	
		1/4				•	
5/16					•		
3/8				•			
 ED	1				•		
	2				•		
	3				•		
	4				•		
 ES	5,5				•		
	6,5				•		
	8				•		
	10				•		
	J.210	•	•	•	•	•	
	J.215	•	•	•	•	•	
	J.120A	•	•	•	•	•	
	J.240A	•	•	•	•	•	
	J.110			•			
	J.235				•		
	J.236				•		
	J.216				•		
J.140A				•			
	PL.59A	PL.59A	PL.12A	PL.78A	PL.69A		
	BP.109	BP.109	BP.109	BT.105	BP.115		
		478 x 234 x 72 mm	478 x 234 x 72 mm	478 x 234 x 72 mm	540 x 80 x 58 mm	332 x 143 x 67 mm	
		4,18 Kg	4,110 Kg	3,73 Kg	7,38 Kg	2,70 Kg	

**J.430MU**



**JL.430MU**



**J.430UP**



**J.450U**















**J.420AU**



# 3/8" SOCKET SETS





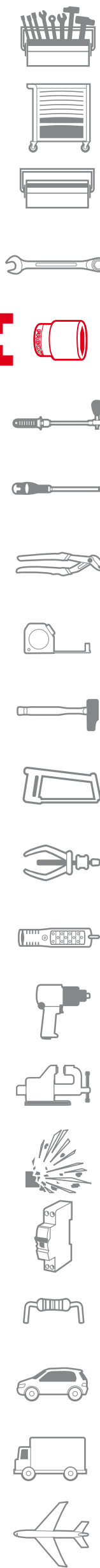



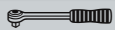

## RACK OR SET

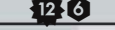
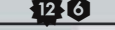
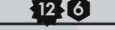
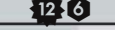
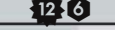
		<b>J.40E</b>	<b>JL.40E</b>	<b>JL.41E</b>	<b>J.40U</b>	<b>JL.40U</b>	<b>JTX.40</b>	<b>JT.40</b>	
		 Standard	 Long	 Long	 Standard	 Long	TORX Standard	TORX SCREWDRIVER SOCKETS Standard	
 mm	7	•	•						
	8	•	•						
	9	•	•						
	10	•	•						
	11	•	•						
	12	•	•						
	13	•	•						
	14	•	•						
	15	•	•						
	16	•		•					
	17			•					
	18			•					
	19			•					
 "	1/4				•	•			
	5/16				•	•			
	3/8				•	•			
	7/16				•	•			
	1/2				•	•			
	9/16				•	•			
	5/8				•	•			
	11/16				•	•			
3/4					•				
13/16					•				
Sockets TORX®	E4						•		
	E5						•		
	E6						•		
	E7						•		
	E8						•		
	E10						•		
 JT  mm	8							•	
	10							•	
	12							•	
	14							•	
	16							•	
		CKS.94				CKS.91			
		0,380 Kg	0,590 Kg	0,870 Kg	0,340 Kg	0,840 Kg	0,090 Kg	0,280 Kg	



# 3/8" MODULES IN THERMOFORMED TRAYS

## METRIC/ INCH

		MOD.JL1	MOD.J1	MOD.J5	MOD.J7	MOD.J2
		JL.161	J.161	J.171	J.161+J.174	J.161
						
 mm	7	•	•	•	•	
	8	•	•	•	•	
	9	•	•	•	•	
	10	•	•	•	•	
	11	•	•	•	•	
	12	•	•	•	•	
	13	•	•	•	•	
	14	•	•	•	•	
	15	•	•	•	•	
	16	•	•	•	•	
	17	•	•	•	•	
	18	•	•	•	•	
	19	•	•	•	•	
	20					
	21	•	•	•	•	
	22	•	•	•	•	
23				•		
24				•		
 "	1/4					•
	5/16					•
	3/8					•
	7/16					•
	1/2					•
	9/16					•
	5/8					•
	11/16					•
	3/4					•
	13/16					•
	7/8					•
	15/16					•
	1					
	 JT	1/8				
5/32						
3/16						
7/32						
1/4						
5/16						
3/8						
 EP	1					
	2					
	3					
	4					
 ES	5,5					
	6,5					
	8					
	10					
	J.210	•	•			•
	J.215	•	•			•
	J.120A	•	•	•	•	•
	J.240A	•	•	•	•	•
	J.210RC			•	•	
	J.215RC			•	•	
	J.210S					
	J.110					
	J.235	•				
	J.232	•				
	J.216					
	J.140A					
		PL.686		PL.322A	PL.322A	PL.665
435 x 198 x 55 mm				420 x 180 x 55 mm		
	2,25 Kg	1,80 Kg	1,75 Kg	2,20 Kg	1,52 Kg	

MOD.JL1



MOD.J1



MOD.J5















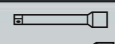
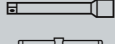

MOD.J7



MOD.J2

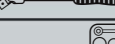

# 3/8" MODULES IN FOAM TRAYS BI-COLOURED-METRIC

		<b>MODM.JL1</b>
		JL.161
		6
	J.8H	•
	J.9H	•
	J.10H	•
	J.11H	•
	J.12H	•
	J.13H	•
	J.14H	•
	J.15H	•
	J.16H	•
	J.17H	•
	J.18H	•
	J.19H	•
	J.21H	•
	J.22H	•
	         	J.210
J.215		•
J.120A		•
J.240A		•
J.210RC		•
J.215RC		•
J.210S		•
J.110		•
J.235		•
J.232		•
J.216		•
J.140A		•
		PM.MODJL1
		416 x 190 x 50 mm
		1,88 Kg



## Ratchets 3/8"

### 3/8" maintenance free pear head ratchet

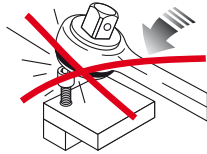
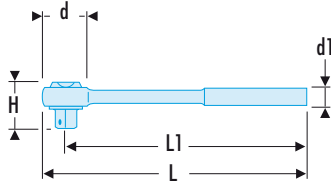

NF ISO 3315, ISO 3315, DIN 3122, ASME B107.10

- Dust proof, maintenance free mechanism.
- 72 teeth mechanism for 5° increments.
- Drive direction switch allows easy reversal even with gloved or greasy hands.
- Palm control system - allows the operator to press down on the head avoiding risk of accidental reverse
- Ultra-compact head.
- Hook for hanging when working at height.
- Ergonomic comfort grip handle design resistant to workshop chemicals and solvents.

➤	d [mm]	d1 [mm]	H [mm]	L [mm]	L1 [mm]	ΔΔ [g]
<b>JL.161</b>	29	27	29	210	195	200

### 3/8" fast action twist handle ratchet

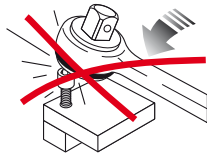
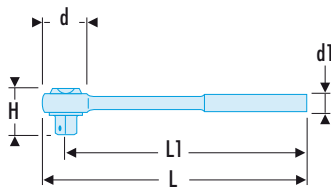

NF ISO 3315, ISO 3315, DIN 3122, ASME B107.10

- 3/8" fast ratchet with rotating handle:
- Rotating handle jack: work twice as fast in confined spaces.
- 6° increments for final tightening.
- Socket safety locking = no sockets lost in your machines.
- Palm control system - allows the operator to press down on the head avoiding risk of accidental reverse.

➤	d [mm]	d1 [mm]	H [mm]	L [mm]	L1 [mm]	ΔΔ [g]
<b>J.360</b>	37	37	39	233	233	442

### 3/8" palm control ratchet

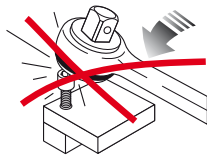
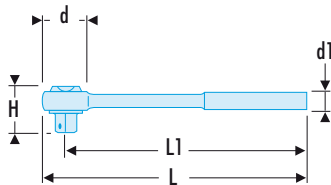

NF ISO 3315, ISO 3315, DIN 3122, ASME B107.10

- 72 teeth mechanism for 5° increments.
- Palm control system - allows the operator to press down on the head avoiding risk of accidental reverse.
- Ring reversing.

➤	d [mm]	d1 [mm]	H [mm]	L [mm]	L1 [mm]	ΔΔ [g]
<b>J.161</b>	30	25	32	175	164	210

### Standard 3/8" ratchet

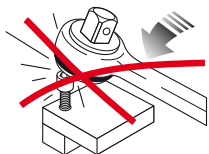
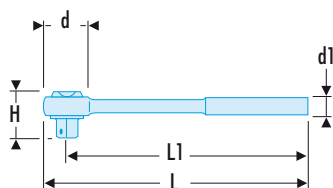

NF ISO 3315, ISO 3315, DIN 3122, ASME B107.10

- 72 teeth mechanism for 5° increments.
- Reversing by rotating cap.

➤	d [mm]	d1 [mm]	H [mm]	L [mm]	L1 [mm]	ΔΔ [g]
<b>J.151A</b>	30	21	29	179	179	200

### 3/8" locking ratchet

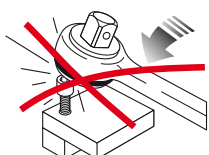
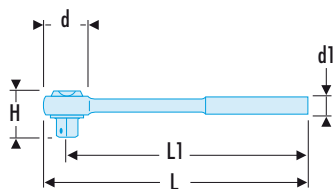

NF ISO 3315, ISO 3315, DIN 3122, ASME B107.10

- 72 teeth mechanism for 5° increments.
- Palm control system - allows the operator to press down on the head avoiding risk of accidental reverse.
- Ring reversing.
- Socket safety locking = no sockets lost in your machines.
- Long handle to reduce fatigue.

➤	d [mm]	d1 [mm]	H [mm]	L [mm]	L1 [mm]	ΔΔ [g]
<b>J.171</b>	32,5	28	36	210	195	260

### 3/8" long-reach locking ratchet

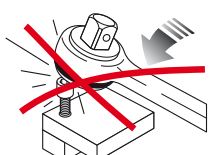
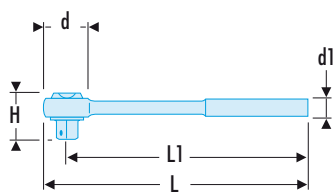

NF ISO 3315, ISO 3315, DIN 3122, ASME B107.10

- 72 teeth mechanism for 5° increments.
- Palm control system - allows the operator to press down on the head avoiding risk of accidental reverse.
- Ring reversing.
- Socket safety locking = no sockets lost in your machines.
- Long handle to reduce fatigue.

➤	d [mm]	d1 [mm]	H [mm]	L [mm]	L1 [mm]	ΔΔ [g]
<b>J.174</b>	32,5	28	36	250	234	320

### 3/8" long-reach hinged ratchet

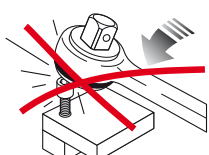
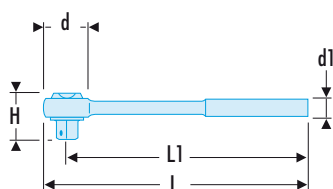

NF ISO 3315, ISO 3315, DIN 3122, ASME B107.10

- 72 teeth mechanism for 5° increments.
- Palm control system - allows the operator to press down on the head avoiding risk of accidental reverse.
- Ring reversing.
- Extra-long handle to apply more torque without effort.
- Stiffened joint to maintain the position even with an extension and the socket engaged.

➤	d [mm]	d1 [mm]	H [mm]	L [mm]	L1 [mm]	ΔΔ [g]
<b>J.153A</b>	30	25	32	278	263	315

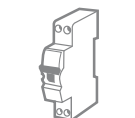



# "Junior" 3/8" range

## 3/8" hinged head ratchet with metal handle

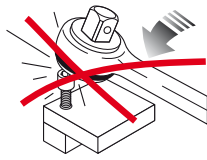
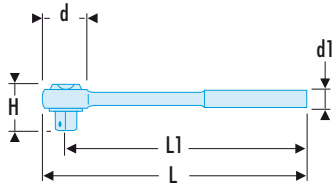



NF ISO 3315, ISO 3315, DIN 3122, ASME B107.10

- 72 teeth mechanism for 5° increments.
- Palm control system - allows the operator to press down on the head avoiding risk of accidental reverse.
- Stiffened joint to maintain the position even with an extension and the socket engaged.
- Full metal handle with knurled grip.

➤	d [mm]	d1 [mm]	H [mm]	L [mm]	L1 [mm]	ΔΔ [g]
<b>J.158A</b>	30	16	32	273	258	350

## MAINTENANCE OF 3/8" RATCHETS

➤	J.171	J.161	J.151A	J.174	J.153A	J.161E	J.155A	J.157A	J.158A	J.159A	J.156
<b>Caps</b>											
 <b>J.161C</b>		•				•	•	•	•	•	
<b>S.156C</b>											•
<b>J.151AC</b>			•								
<b>Spare part kit</b>											
 <b>J.161RN</b>		•				•	•	•	•	•	
<b>S.151RN</b>											•
<b>J.151RN</b>			•								
<b>Rotors</b>											
 <b>J.151AR</b>		•	•			•	•	•	•	•	
<b>J.151R</b>											•

## Accessories 3/8"

### 3/8" hinged bar

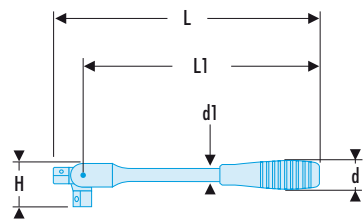

NF ISO 3315, ISO 3315, DIN 3122, ASME B107.10

- Stiffened joint.
- Finish: bright chrome.

➤	d [mm]	d1 [mm]	H [mm]	L [mm]	L1 [mm]	ΔΔ [g]
<b>J.140A</b>	25	10	33,5	260	235,5	230

### 3/8" drive metal-grip hinged handle

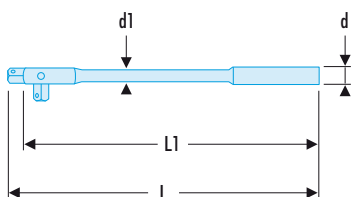

NF ISO 3315, ISO 3315, DIN 3122, ASME B107.10

- Stiffened joint.
- Finish: bright chrome.

➤	d [mm]	d1 [mm]	L [mm]	L1 [mm]	ΔΔ [g]
<b>J.145</b>	17	11	255	245	290

3/8" drive sliding tee

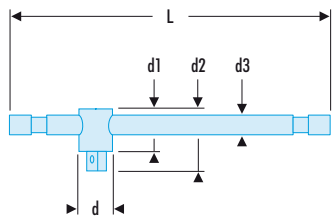

NF ISO 3315, ISO 3315, DIN 3122, ASME B107.10

- Friction-head allows bar to form a T or L-handle.
- Finish: bright chrome.

➤	d [mm]	d1 [mm]	d2 [mm]	d3 [mm]	L [mm]	ΔΔ [g]
<b>J.120A</b>	20	23	34	12	200	215

3/8" drive speed brace

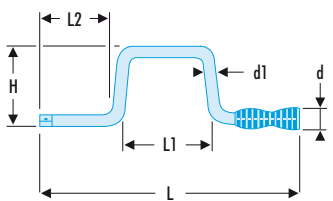

NF ISO 3315, ISO 3315, DIN 3122, ASME B107.10

- For fast rotation.
- PVC rotating handle.
- Finish: bright chrome.

➤	d [mm]	d1 [mm]	H [mm]	L [mm]	L1 [mm]	L2 [mm]	ΔΔ [g]
<b>J.110A</b>	29	12	115	382	130	110	395

3/8" drive metal-grip speed brace

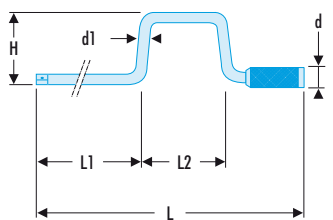

NF ISO 3315, ISO 3315, DIN 3122, ASME B107.10

- For fast rotation.
- Metal rotating handle.
- Finish: bright chrome.

➤	d [mm]	d1 [mm]	H [mm]	L [mm]	L1 [mm]	L2 [mm]	ΔΔ [g]
<b>J.115</b>	29	9,5	75	420	195	125	425

J.222A 3/8" drive flexible spinner



- Ergonomic bi-material grip.
  - For fasteners where access is difficult.
  - Length 295 mm.
  - Finish: bright chrome.
- Weight: 230 g.

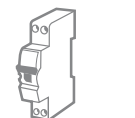
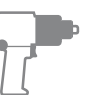
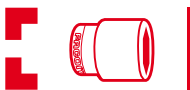

# "Junior" 3/8" range

## 3/8" drive tee with universal joint

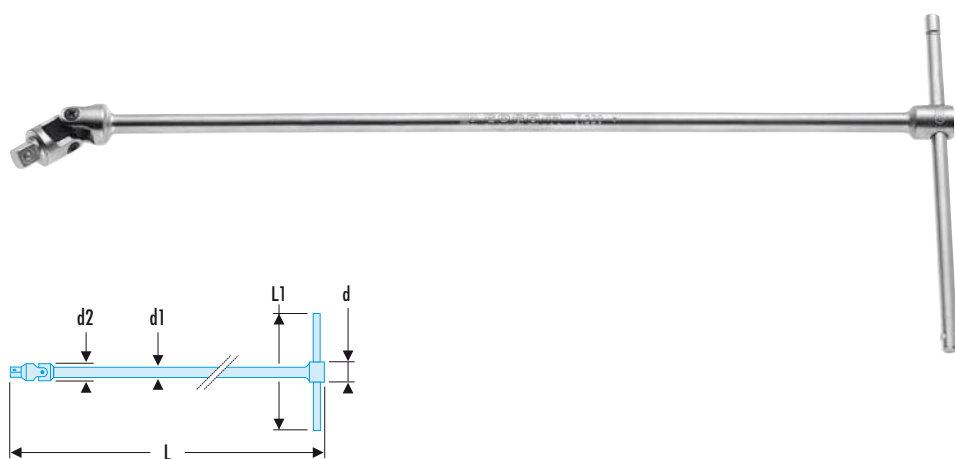

- Universal joint withstands high torques and is spring-steadied in position.
- Long reach and working angle up to 65° allows access to recessed fasteners.
- Sliding tee handle for a T or L position for more power.
- Finish: bright chrome.

Part No.	d [mm]	d1 [mm]	d2 [mm]	L [mm]	L1 [mm]	ΔΔ [g]
<b>J.229A</b>	17	10	19	460	175	410

## 3/8" long-reach drive tee with universal joint

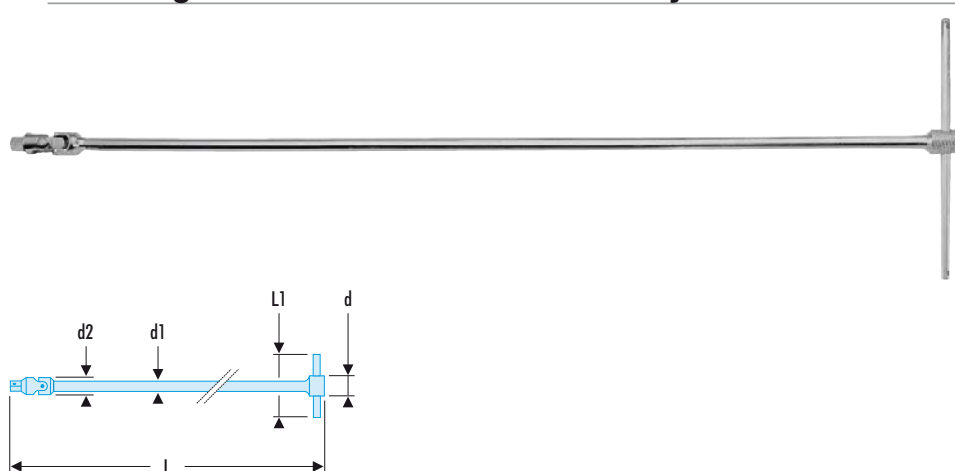

- Universal joint withstands high torques and is spring-steadied in position.
- Long reach and working angle up to 65° allows access to recessed fasteners.
- Sliding tee handle for a T or L position for more power.
- Finish: bright chrome.

Part No.	d [mm]	d1 [mm]	d2 [mm]	L [mm]	L1 [mm]	ΔΔ [g]
<b>J.228</b>	18	12	19	700	190	660

## J - 3/8" drive extensions

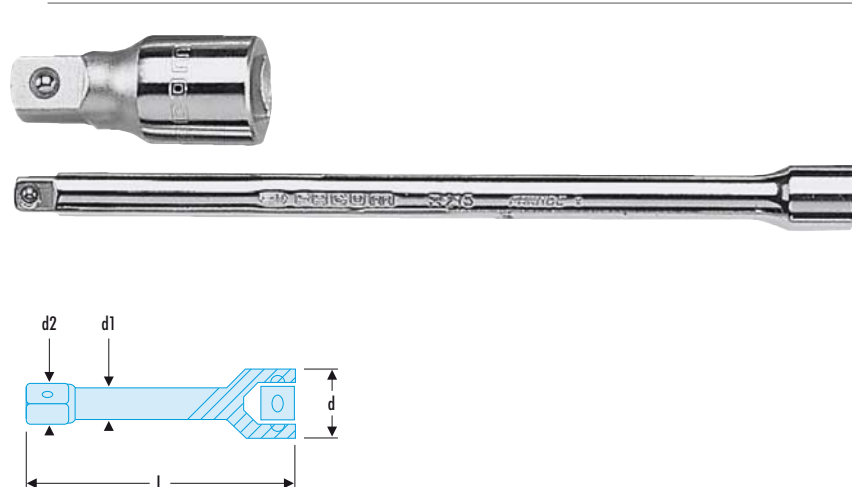

NF ISO 3316, ISO 3316, DIN 3123, ASME B107.10

- Finish: bright chrome.

Part No.	d [mm]	d1 [mm]	d2 [mm]	L [mm]	ΔΔ [g]
<b>J.208</b>	18	10	12,6	50	62
<b>J.209</b>	18	10	12,6	75	86
<b>J.210</b>	18	10	12,6	125	127
<b>J.215</b>	18	10	12,6	250	230
<b>J.217</b>	18	10	12,6	500	445

## J.S - 3/8" drive wobble extensions

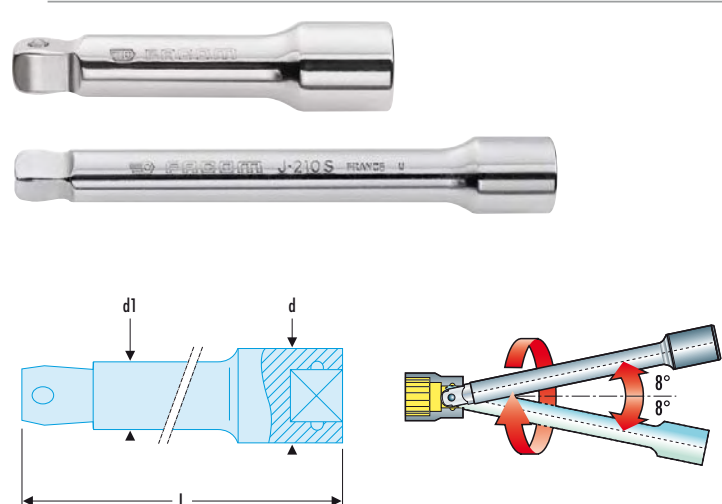

- Square drive profile gives 8° working angle.
- Useful where access is limited.
- Finish: bright chrome.

Part No.	d [mm]	d1 [mm]	L [mm]	ΔΔ [g]
<b>J.209S</b>	18	12,5	75	80
<b>J.210S</b>	18	12,5	125	130

WOBBLE EXTENSION

Hard to access with a socket or universal joint? USE A WOBBLE EXTENSION !

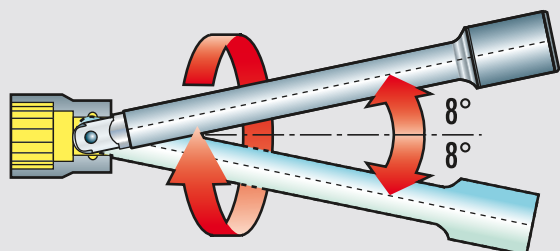

J.RC - 3/8" drive locking extensions

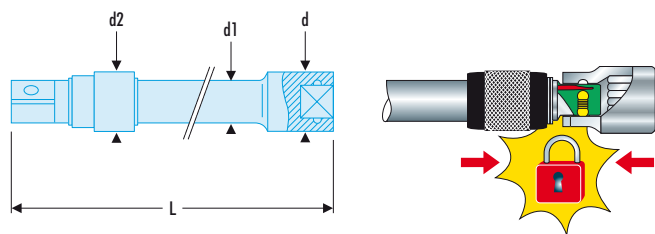

NF ISO 3316, ISO 3316, DIN 3123, ASME B107.10

- Total safety as lock system prevents socket loss.
- Finish: bright chrome with phosphate-hardened ring.

🔑	d [mm]	d1 [mm]	d2 [mm]	L [mm]	ΔΔ [g]
J.210RC	18	12,5	18	125	135
J.215RC	18	12,5	18	250	240
J.217RC	18	12,5	18	500	490

3/8" wobble extension

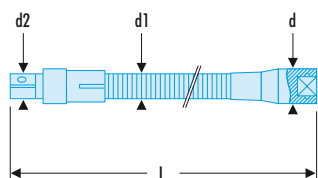

ASME B107.10

- Maximum access.
- Unsuitable for high torques.
- Finish: bright chrome.

🔑	d [mm]	d1 [mm]	d2 [mm]	L [mm]	ΔΔ [g]
J.216	18	12,6	15	200	145

3/8" universal joint

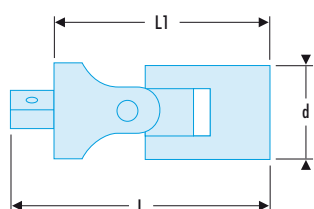

NF ISO 3316, ISO 3316, DIN 3123, ASME B107.10

- Spring-stiffened joints.
- Finish: bright chrome.

🔑	d [mm]	L [mm]	L1 [mm]	ΔΔ [g]
J.240A	18	51,5	36,5	60



# "Junior" 3/8" range

## 3/8" to 1/4" coupler

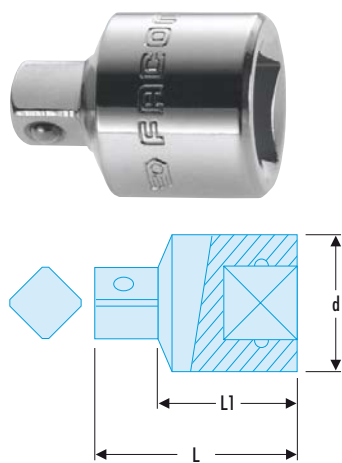

NF ISO 3316, ISO 3316, DIN 3123, ASME B107.10

- For adapting 1/4" drive sockets.
- Max. torque 62 N.m.
- Finish: bright chrome.

Part No.	d [mm]	L [mm]	L1 [mm]	ΔΔ [g]
J.230	17,5	24,5	17	25

## 3/8" to 1/2" coupler

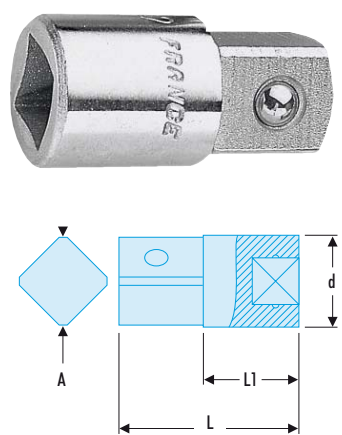

NF ISO 3316, ISO 3316, DIN 3123, ASME B107.10

- For adapting 1/2" drive sockets.
- Finish: bright chrome.

Part No.	A [mm]	d [mm]	L [mm]	L1 [mm]	ΔΔ [g]
J.232	16,5	18	34,5	19	45

## D.169 Set of 3 couplers



- Allows use of square drivers smaller than socket drive sizes:
    - 1/4" square drive + D.169RJ --> 3/8" socket.
    - 3/8" square drive + D.169JS --> 1/2" socket.
    - 1/2" square drive --> 3/4" socket.
  - Compactness means that fewer tools are needed for in situ maintenance operations.
  - Magnetic retainer and locking system (JS and SK).
  - Knurl allows hand tightening where access is difficult.
- Weight: 96 g.

## J - 3/8" bit holder sockets with retaining clip

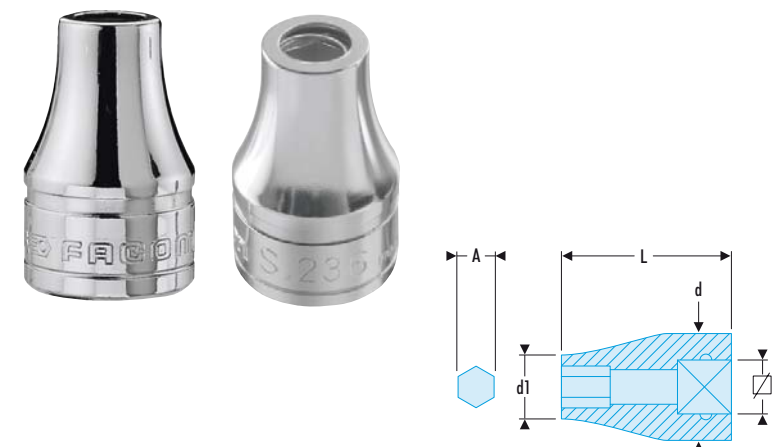

NF ISO 2725-1, NF ISO 1173, ISO 2725-1, ISO 1173, DIN 3124

- Spring clip for frequent bit changes.
- For frequent removals.
- Finish: bright chrome.
- J.235: 1/4 bits.
- J.236: 5/16 bits.

Part No.	A ["]	Square ["]	d [mm]	d1 [mm]	L [mm]	ΔΔ [g]
J.235	1/4	3/8	18,0	11,3	30	26
J.236	5/16	3/8	18,0	14	30	30

### 3/8" bit holder socket with locking ring



NF ISO 2725-1, NF ISO 1173, ISO 2725-1, ISO 1173, DIN 3124

- Bit lock.
- Square drive has side-hole for ball or plunger lock.

EF	A ["]	Square ["]	L [mm]	ΔΔ [g]
<b>EF.J</b>	1/4	3/8	43	48

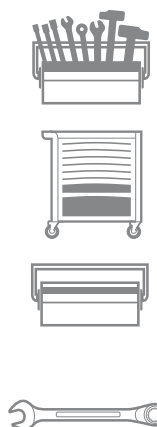

## Sockets 3/8"

### J.H - 3/8" metric 6-point sockets

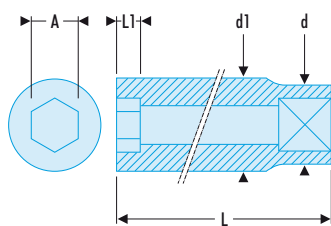

NF ISO 2725-1, NF ISO 1711-1, ISO 2725-1, ISO 1711-1, DIN 3124, ASME B107.5

- OGV® profile: more powerful tightening, preserves fasteners.
- Available as rack sets (Ref J.40U).
- Finish: bright chrome.

EF	A [mm]	⊙ [mm]	d [mm]	d1 [mm]	L [mm]	L1 [mm]	ΔΔ [g]
<b>J.7H</b>	7	6	17,6	11,0	27	6,0	24
<b>J.8H</b>	8	6	17,6	12,2	27	6,5	25
<b>J.9H</b>	9	6	17,6	13,5	27	6,7	25
<b>J.10H</b>	10	6	17,6	14,7	27	7,8	26
<b>J.11H</b>	11	6	17,6	16,0	27	9,0	27
<b>J.12H</b>	12	6	17,6	17,2	27	9,5	26
<b>J.13H</b>	13	6	17,4	18,3	30	10,4	36
<b>J.14H</b>	14	6	17,6	19,5	30	10,5	34
<b>J.15H</b>	15	6	18,9	20,8	30	12,0	38
<b>J.16H</b>	16	6	19,9	22,0	30	12,0	45
<b>J.17H</b>	17	6	21,7	23,4	30	13,0	52
<b>J.18H</b>	18	6	21,7	24,7	33	13,0	69
<b>J.19H</b>	19	6	22,7	26,0	33	14,0	62
<b>J.20H</b>	20	6	22,2	27,2	33	15,0	70
<b>J.21H</b>	21	6	23,5	28,5	33	16,0	75
<b>J.22H</b>	22	6	24,7	29,7	33	16,5	80
<b>J.23H</b>	23	6	26,0	31,0	33	16,5	90
<b>J.24H</b>	24	6	26,3	31,3	33	16,5	86

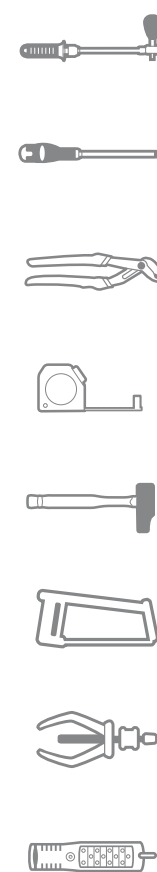

### J - 3/8" metric 12-point sockets

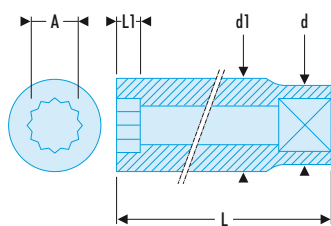

NF ISO 2725-1, NF ISO 1711-1, ISO 2725-1, ISO 1711-1, DIN 3124, ASME B107.5

- OGV® profile: more powerful tightening, preserves fasteners.
- Finish: bright chrome.

EF	A [mm]	⊙ [mm]	d [mm]	d1 [mm]	L [mm]	L1 [mm]	ΔΔ [g]
<b>J.7</b>	7	12	17,6	11,0	27	6,0	24
<b>J.8</b>	8	12	17,6	12,2	27	6,5	25
<b>J.9</b>	9	12	17,6	13,5	27	6,7	25
<b>J.10</b>	10	12	17,6	14,7	27	7,8	26
<b>J.11</b>	11	12	17,6	16,0	27	9,0	27
<b>J.12</b>	12	12	17,6	17,2	27	9,5	26
<b>J.13</b>	13	12	17,5	18,3	30	10,4	36
<b>J.14</b>	14	12	17,7	19,5	30	10,5	34
<b>J.15</b>	15	12	19,0	20,8	30	12,0	38
<b>J.16</b>	16	12	20,0	22,0	30	12,0	45
<b>J.17</b>	17	12	21,7	23,4	30	13,0	52
<b>J.18</b>	18	12	21,7	24,7	33	13,0	69
<b>J.19</b>	19	12	22,7	26,0	33	14,0	62
<b>J.20</b>	20	12	22,2	27,2	33	15,0	70
<b>J.21</b>	21	12	23,5	28,5	33	16,0	75
<b>J.22</b>	22	12	24,7	29,7	33	16,5	80
<b>J.23</b>	23	12	26,0	31,0	33	16,5	90
<b>J.24</b>	24	12	26,3	31,3	33	16,5	86

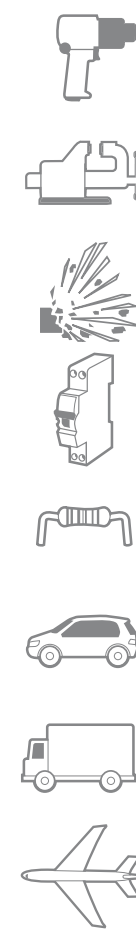

# "Junior" 3/8" range

## ▣ J - 3/8" inch 12-point sockets

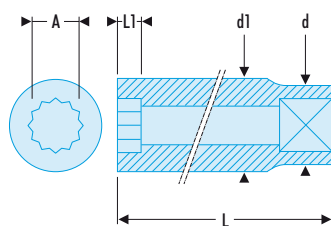

### ASME B107.1

- OGV® profile: more powerful tightening, preserves fasteners.
- Available as rack sets (Ref J.40U).
- Finish: bright chrome.

➤	A ["]	⚙ [mm]	d [mm]	d1 [mm]	L [mm]	L1 [mm]	ΔΔ [g]
J.1/4	1/4	12	17,5	10,0	27	6,0	24
J.5/16	5/16	12	17,5	11,9	27	6,5	25
J.3/8	3/8	12	17,6	14,1	27	7,5	26
J.7/16	7/16	12	17,5	16,0	27	9,0	27
J.1/2	1/2	12	17,5	18,1	30	10,4	36
J.9/16	9/16	12	17,7	19,5	30	10,5	34
J.5/8	5/8	12	20,0	22,0	30	12,0	46
J.11/16	11/16	12	21,0	24,0	33	13,0	74
J.3/4	3/4	12	22,7	26,0	33	14,0	76
J.13/16	13/16	12	23,0	28,0	33	16,0	79
J.7/8	7/8	12	24,7	29,7	33	16,5	104
J.15/16	15/16	12	26,3	31,3	33	16,5	136
J.1'	1	12	28,3	33,3	33	16,5	156

## ▣ JB - 3/8" inch 12-point sockets

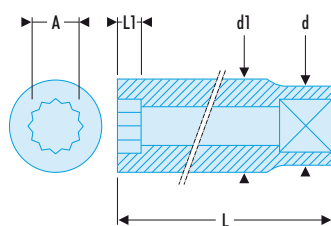

### ASME B107.1

- OGV® profile: more powerful tightening, preserves fasteners.
- Built to aeronautical specifications.
- Finish: bright chrome.

➤	A ["]	⚙ [mm]	d [mm]	d1 [mm]	L [mm]	L1 [mm]	ΔΔ [g]
JB.1/4	1/4	12	16,7	9,7	27	6,0	20
JB.5/16	5/16	12	16,7	11,7	27	6,8	21
JB.11/32	11/32	12	16,7	12,7	27	6,8	22
JB.3/8	3/8	12	16,7	13,7	27	7,5	23
JB.7/16	7/16	12	16,7	15,6	27	9,0	24
JB.1/2	1/2	12	16,7	17,6	30	10,4	27
JB.9/16	9/16	12	18,5	19,6	30	10,5	33
JB.5/8	5/8	12	20,0	21,6	30	12,0	42
JB.11/16	11/16	12	22,0	23,6	32	13,0	50
JB.3/4	3/4	12	22,8	25,4	32	15,0	55
JB.13/16	13/16	12	24,0	27,4	32	16,0	68
JB.7/8	7/8	12	24,0	29,4	32	16,0	68

## ▣ J.HLA - 3/8" long-reach metric 6-point sockets

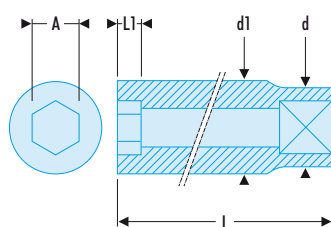

### NF ISO 2725-1, NF ISO 1711-1, ISO 2725-1, ISO 1711-1, DIN 3124, ASME B107.5

- OGV® profile: more powerful tightening, preserves fasteners.
- Long-reach sockets for long recess or thread access.
- Available as rack set Ref JL.40E (7 --> 15 mm) and Ref RL.41E (16 --> 24 mm).
- Finish: bright chrome.

➤	A [mm]	⚙ [mm]	d [mm]	d1 [mm]	L [mm]	L1 [mm]	ΔΔ [g]
J.7HLA	7	6	17,3	10,6	55	6,0	44
J.8HLA	8	6	17,3	12,0	55	7,5	46
J.9HLA	9	6	17,3	13,0	55	7,5	47
J.10HLA	10	6	17,3	14,5	55	9,0	50
J.11HLA	11	6	17,3	16,0	55	10,5	53
J.12HLA	12	6	17,2	16,8	55	12,0	53
J.13HLA	13	6	17,0	18,0	55	12,0	54
J.14HLA	14	6	18,0	20,0	55	15,0	60
J.15HLA	15	6	20,0	21,0	60	15,0	75
J.16HLA	16	6	20,0	22,0	60	15,0	85
J.17HLA	17	6	22,0	23,5	60	15,0	102
J.18HLA	18	6	23,0	24,5	60	18,0	109
J.19HLA	19	6	24,0	25,0	60	18,0	110
J.21HLA	21	6	26,0	27,0	60	18,0	123
J.22HLA	22	6	28,0	29,0	60	21,0	150
J.24HLA	24	6	30,0	31,0	60	24,0	176

## ■ J.LA - 3/8" long-reach metric 12-point sockets

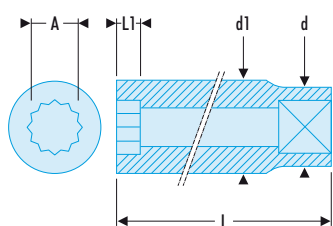

NF ISO 2725-1, NF ISO 1711-1, ISO 2725-1, ISO 1711-1, DIN 3124, ASME B107.5

- OGV® profile: more powerful tightening, preserves fasteners.
- Long-reach sockets for long recess or thread access.
- Available as rack sets (Ref JL.40U).
- Finish: bright chrome.

➤	A [mm]	12 [mm]	d [mm]	d1 [mm]	L [mm]	L1 [mm]	ΔΔ [g]
J.7LA	7	12	17,3	10,6	55	6,0	44
J.8LA	8	12	17,3	12,0	55	7,5	46
J.9LA	9	12	17,3	13,0	55	7,5	47
J.10LA	10	12	17,3	14,5	55	9,0	50
J.11LA	11	12	17,3	16,0	55	10,5	53
J.12LA	12	12	17,3	16,8	55	12,0	53
J.13LA	13	12	17,2	18,0	55	12,0	54
J.14LA	14	12	17	20,0	55	15,0	60
J.15LA	15	12	18	21,0	55	15,0	75
J.16LA	16	12	20	22,0	60	15,0	85
J.17LA	17	12	20	23,5	60	15,0	102
J.18LA	18	12	22	24,5	60	18,0	109
J.19LA	19	12	23	25,0	60	18,0	110
J.21LA	21	12	24	27,0	60	18,0	123
J.22LA	22	12	26	29,0	60	21,0	150
J.24LA	24	12	30	31,0	60	21,0	176

## ■ J.LA - 3/8" inch 12-point sockets

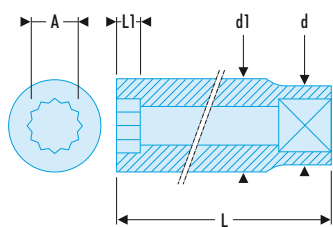

ASME B107.1

- OGV® profile: more powerful tightening, preserves fasteners.
- Long-reach sockets for long recess or thread access.
- Finish: bright chrome.

➤	A ["]	12 [mm]	d [mm]	d1 [mm]	L [mm]	L1 [mm]	ΔΔ [g]
J.1/4LA	1/4	12	17,5	10,6	44,7	4,0	36
J.5/16LA	5/16	12	17,5	12,4	44,7	4,3	36
J.3/8LA	3/8	12	17,5	14,3	44,7	4,7	41
J.7/16LA	7/16	12	17,5	16,2	44,7	6,2	45
J.1/2LA	1/2	12	18,2	18,2	44,7	7,4	50
J.9/16LA	9/16	12	20,5	20,5	48,0	9,0	72
J.5/8LA	5/8	12	22,3	22,3	63,8	10,2	104
J.11/16LA	11/16	12	23,8	23,8	63,8	10,2	113
J.3/4LA	3/4	12	25,3	25,3	63,8	11,8	127
J.13/16LA	13/16	12	27,0	27,0	63,8	12,3	140
J.7/8LA	7/8	12	30,2	30,2	63,8	12,7	181
J.15/16LA	15/16	12	31,8	31,8	63,8	12,7	185
J.1"LA	1	12	33,4	33,4	63,8	12,7	185

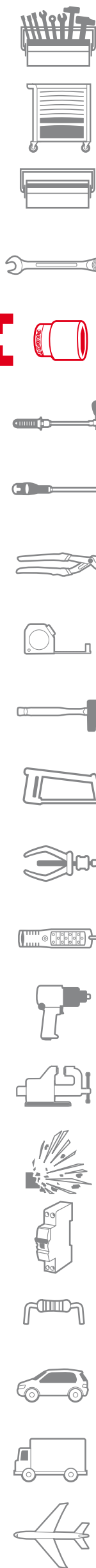



# "Junior" 3/8" range

## ▣ J.F - 3/8" drive hinged inch 12-point sockets

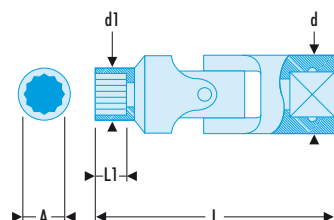

### ASME B107.1

- OGV® profile: more powerful tightening, preserves fasteners.
- Compact solution used instead of universal joint.
- Finish: bright chrome.

➤	A ["]	⚙ [mm]	d [mm]	d1 [mm]	L [mm]	L1 [mm]	ΔΔ [g]
<b>J.3/8F</b>	3/8	12	19	14,0	47,5	8,3	55
<b>J.7/16F</b>	7/16	12	19	15,8	49,0	9,8	55
<b>J.1/2F</b>	1/2	12	19	18,3	50,5	11,3	60
<b>J.9/16F</b>	9/16	12	19	19,5	50,5	11,3	60
<b>J.5/8F</b>	5/8	12	19	22,00	53,5	12,8	70
<b>J.11/16F</b>	11/16	12	19	24,00	54,5	13,8	72
<b>J.3/4F</b>	3/4	12	19	25,8	56,5	15,8	80

## Torx® sockets 3/8"

### ▣ JTX - 3/8" Torx® sockets

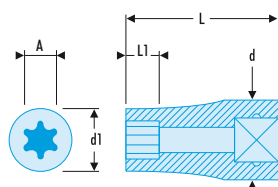

- For Torx® fasteners.
- Available as metal rack set (Ref JTX.40).
- Finish: bright chrome.

➤	A [mm]	Torx [No]	d [mm]	d1 [mm]	L [mm]	L1 [mm]	ΔΔ [g]
<b>JTX.8</b>	7,29	E8	17,3	9,9	26	5,6	40
<b>JTX.10</b>	9,19	E10	17,3	11,8	26	6,4	40
<b>JTX.12</b>	10,95	E12	17,3	14,5	26	8,0	40
<b>JTX.14</b>	12,67	E14	17,3	15,7	26	8,8	50
<b>JTX.16</b>	14,70	E16	17,3	18,0	26	9,6	100

## Screwdriver sockets 3/8"

### ▣ JT - 3/8" drive metric bit sockets

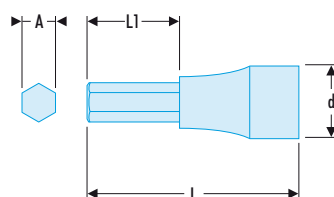

- Removable bits.
- J.235 socket.
- Finish: bright chrome with phosphate-hardened tip.
- Available as rack set Ref JT.40.

➤	A [mm]	d [mm]	Bits	L [mm]	L1 [mm]	ΔΔ [g]
<b>JT.3</b>	3	18	EH.103	45,0	15,0	31
<b>JT.4</b>	4	18	EH.104	45,0	15,0	31
<b>JT.5</b>	5	18	EH.105	45,0	15,0	32
<b>JT.6</b>	6	18	EH.106	45,0	15,0	33
<b>JT.7</b>	7	18	EH.107	45,0	15,0	34
<b>JT.8</b>	8	18	EH.208	47,5	17,5	43
<b>JT.10</b>	10	18	EH.210	47,5	17,5	50

■ JT - 3/8" drive inch bit sockets

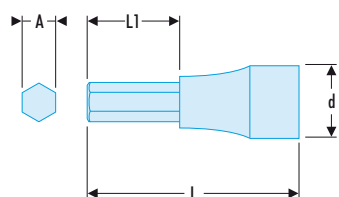

- Removable bits.
- J.235 sockets.
- Finish: bright chrome with phosphate-hardened tip.
- Available as metal rack set (Ref JT.40).

➤	A ["]	d [mm]	Bits	L [mm]	L1 [mm]	ΔΔ [g]
JT.1/8	3,17	18	EH.101/8	45	15,0	31
JT.5/32	3,96	18	EH.105/32	45	15,0	31
JT.3/16	4,76	18	EH.103/16	45	15,0	31
JT.7/32	5,56	18	EH.107/32	45	15,0	32
JT.1/4	6,35	18	EH.101/4	45	15,0	33
JT.5/16	7,94	18	EH.205/16	47,5	17,5	43
JT.3/8	9,53	18	EH.203/8	47,5	17,5	50

■ JX - 3/8" Torx® drive sockets

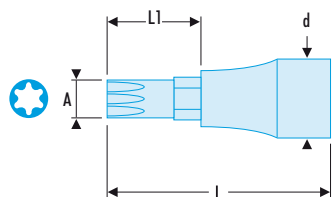

- Removable bits.
- J.236 socket.
- Finish: bright chrome with phosphate-hardened tip.

➤	A [mm]	Torx [No]	Bits	L [mm]	L1 [mm]	ΔΔ [g]
JX.10	2,72	T10	EX.110	46,0	16,0	33,50
JX.15	3,26	T15	EX.115	46,0	16,0	33,50
JX.20	3,84	T20	EX.120	46,0	16,0	33,50
JX.25	4,40	T25	EX.125	46,0	16,0	33,50
JX.27	4,96	T27	EX.127	46,0	16,0	33,50
JX.30	5,49	T30	EX.130	46,0	16,0	33,50
JX.40	6,60	T40	EX.140	52,5	22,5	45,00
JX.45	7,77	T45	EX.145	52,5	22,5	45,00
JX.50	8,79	T50	EX.150	52,5	22,5	47,50
JX.55	11,17	T55	EX.155	52,5	22,5	61,00

CREATE YOUR OWN BIT SOCKETS

Screw bits



- Series 1 ⬡ 1/4"
- Series 2 ⬡ 5/16"

➤ See Section 7

Bit holder 3/8"



**J.235**  
⬡ 1/4"  
6.35 mm









**J.236**  
⬡ 5/16"  
7.94 mm

➤ See p. 270

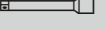

# 1/2" "DETECTION BOX" SETS

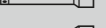
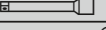
## METRIC DIMENSIONS

		SL.DBOX1	SL.DBOX112	SL.DBOX4	SL.DBOX412
		SL.161	SL.161	SL.161	SL.161
		6	12	6	6
Socket type		Standard	Standard	Standard	Standard
	mm				
	8	•	•	•	•
	9			•	•
	10	•	•	•	•
	11	•	•	•	•
	12	•	•	•	•
	13	•	•	•	•
	14	•	•	•	•
	15	•	•	•	•
	16	•	•	•	•
	17	•	•	•	•
	18	•	•	•	•
	19	•	•	•	•
	21	•	•	•	•
	22	•	•	•	•
23			•	•	
24	•	•	•	•	
27	•	•	•	•	
30	•	•	•	•	
32	•	•	•	•	
	S.210S			•	•
	S.120A			•	•
	S.240A	•	•		
	S.215	•	•		
	S.210	•	•		
		BV.S1NANO		BV.S2NANO	
		340 x 180 x 58 mm			
		3,680 Kg		3,750 Kg	

SL.DBOX1



SL.DBOX112



SL.DBOX4















SL.DBOX412

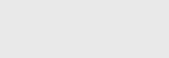

# 1/2" "DETECTION BOX" SETS

## METRIC DIMENSIONS

		S.360DBOX1	S.360DBOX112	S.360DBOX4	S.360DBOX412	S.DBOX500	S.DBOX501
		S.360	S.360	S.360	S.360	S.171	S.171
		Standard	Standard	Standard	Standard	Standard	Standard
 mm	8	•	•	•	•	•	•
	9						
	10	•	•	•	•	•	•
	11	•	•	•	•	•	•
	12	•	•	•	•	•	•
	13	•	•	•	•	•	•
	14	•	•	•	•	•	•
	15	•	•	•	•	•	•
	16	•	•	•	•	•	•
	17	•	•	•	•	•	•
	18	•	•	•	•	•	•
	19	•	•	•	•	•	•
	21	•	•	•	•	•	•
	22	•	•	•	•	•	•
	23						
24	•	•	•	•	•	•	
27	•	•	•	•	•	•	
30	•	•	•	•	•	•	
32	•	•	•	•	•	•	
	S.210S			•	•		
	S.120A			•	•		
	S.240A	•	•			•	•
	S.215A	•	•				
	S.215RC					•	•
	S.210	•	•				
	S.210RC					•	•
		BV.S1NANO		BV.S2NANO		BV.S1NANO	
		340 x 480 x 58 mm				340 x 480 x 58 mm	
		3,890 Kg				3,740 Kg	

S.360DBOX1



S.360DBOX112



S.360DBOX4



S.360DBOX412



S.DBOX500





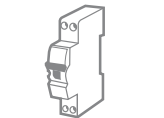
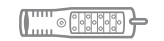
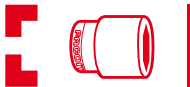

S.DBOX501

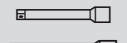

# 1/2" "STANDARD" SETS

## METRIC DIMENSIONS

		S.420B	S.423AP	S.422AP	S.200DP	S.600
		S.151	S.161	S.161	S.161	S.161
<b>12 6</b>		<b>12</b>	<b>6</b>	<b>12</b>	<b>6</b>	<b>6</b>
<b>Socket type</b>		Standard	Standard	Standard	Standard	Standard
	mm					
	8		•	•		•
	9		•	•		•
	10	•	•	•	•	•
	11	•	•	•	•	•
	12	•	•	•	•	•
	13	•	•	•	•	•
	14	•	•	•	•	•
	15	•	•	•	•	•
	16	•	•	•	•	•
	17	•	•	•	•	•
	18	•	•	•	•	•
	19	•	•	•	•	•
	20					
	21	•	•	•	•	•
	22	•	•	•	•	•
	23					
	24	•	•	•	•	•
26						
27				•	•	
28						
29						
30				•	•	
32				•	•	
34						
	S.210		•	•	•	
	S.215	•	•	•	•	•
	S.240A		•	•	•	•
	S.120A					
	S.110					
	S.210RC S.215RC					
		PL.423	PL.422	PL.422	PL.618	PL.619
			BP.112			
		389 x 164 x 66 mm				
		2,33 Kg	2,92 Kg		3,45 Kg	

**S.420B**



**S.423AP  
S.422AP**



**S.200DP**













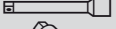

**S.600**



# 1/2" "STANDARD" SETS

## METRIC DIMENSIONS

		S.429EP	S.428EP	S.431ADP	S.430ADP	S.441AP	S.440AP
		S.161	S.161	S.161	S.161	S.161	S.161
		6	12	6	12	6	6
Socket type		Standard	Standard	Standard	Standard	Standard	Standard
	mm						
	8					•	•
	9					•	•
	10	•	•	•	•	•	•
	11	•	•	•	•	•	•
	12	•	•	•	•	•	•
	13	•	•	•	•	•	•
	14	•	•	•	•	•	•
	15	•	•	•	•	•	•
	16						
	17	•	•	•	•	•	•
	18						
	19	•	•	•	•	•	•
	20						
	21		•	•	•	•	•
	22	•	•	•	•	•	•
	23						
24	•	•	•	•	•	•	
26							
27	•	•	•	•	•	•	
28							
29							
30	•	•	•	•	•	•	
32	•	•	•	•	•	•	
34							
	S.210	•	•	•	•	•	•
	S.215	•	•	•	•	•	•
	S.240A	•	•	•	•	•	•
	S.120A	•	•	•	•	•	•
	S.110					•	•
		PL.10A		PL.701		PL.619	
				BR.109			
				478 x 234 x 72 mm			
		4,03 Kg		4,88 Kg		5,95 Kg	

S.429EP  
S.428EP ▼



S.431ADP  
S.430ADP ▼





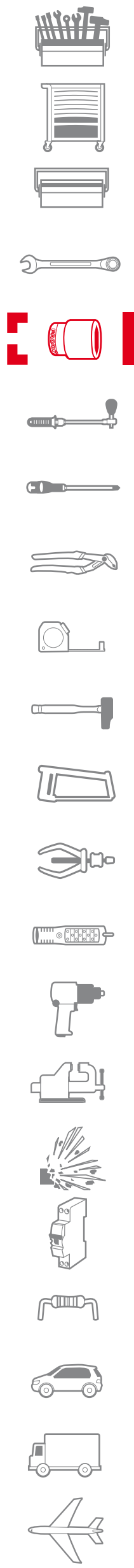









S.441AP  
S.440AP ▼

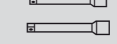

# 1/2" "STANDARD" SETS

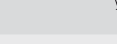
## METRIC DIMENSIONS

		S.441E	S.440E	S.800	S.900	S.447DP	S.446DP
		S.151	S.151	S.161	S.161	S.161	S.161
		6	12	6	6	6	12
Socket type		Standard	Standard	Standard	Standard	Standard	Standard
 mm	8	•	•	•	•		
	9	•	•				
	10	•	•				
	11	•	•				
	12	•	•				
	13	•	•				
	14	•	•				
	15	•	•				
	16	•	•				
	17	•	•				
	18	•	•				
	19	•	•				
	20						
	21	•	•				
	22	•	•				
	23	•	•				
	24	•	•				
26	•	•					
27	•	•					
28	•	•					
29	•	•					
30	•	•					
32	•	•					
34	•	•					
 EP	1			•	•		
	2			•	•		
	3			•	•		
 mm	3						
	4			•	•		
	5			•	•		
	6			•	•	•	•
	7						
8			•	•	•	•	
10					•	•	
 ED	1			•	•		
	2			•	•		
	3			•	•		
 ES	4,5						
	6,5			•	•		
	8			•	•		
	10			•	•		
 EHL	4			•	•		
	5			•	•		
	6			•	•		
	7			•	•		
	8			•	•		
10			•	•			
 EX	20			•	•		
	25			•	•		
	27			•	•		
	30			•	•		
	40			•	•		
	45			•	•		
	50			•	•		
 EXL	30			•	•		
	40			•	•		
	45			•	•		
	50			•	•		
	50			•	•		
 ENH	12					•	•
	24					•	•
 S.206	S.206			•			
	S.208				•		
	S.210	•	•			•	•
	S.210S						
	S.215	•	•	•	•	•	•
	S.240A	•	•	•	•	•	•
	S.120A	•	•			•	•
	S.110	•	•				
	S.236			•	•	•	•
	S.237			•	•	•	•
	PL.708						
	PL.706						
	BP.109						
	478 x 234 x 72 mm						
	5,95 Kg			4,70 Kg	7,30 Kg		5,00 Kg
	PL.291A						

S.441E  
S.440E



S.800



S.900















S.447DP  
S.446DP

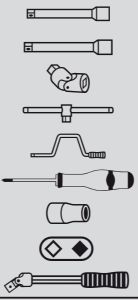
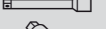



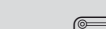
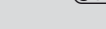

# 1/2" "STANDARD" SETS INCH DIMENSIONS

		S.420AU	S.441AUP	S.440AUP	SL.441AUP	SL.440AUP	S.450UP
 <b>12 6</b> Socket type		S.151 Standard	S.161 Standard	S.161 Standard	SL.161 Standard	SL.161 Standard	S.161+S.156 Standard: long
 "	3/8	•	•	•	•	•	•
	7/16	•	•	•	•	•	•
	1/2	•	•	•	•	•	•
	9/16	•	•	•	•	•	•
	19/32	•	•	•	•	•	•
	5/8	•	•	•	•	•	•
	21/32	•	•	•	•	•	•
	11/16	•	•	•	•	•	•
	3/4	•	•	•	•	•	•
	25/32	•	•	•	•	•	•
	13/16	•	•	•	•	•	•
	7/8	•	•	•	•	•	•
	15/16	•	•	•	•	•	•
	31/32	•	•	•	•	•	•
	1'	•	•	•	•	•	•
	1'1/16	•	•	•	•	•	•
1'1/8	•	•	•	•	•	•	
1'1/4	•	•	•	•	•	•	
 EP	3						•
	4						•
 ENS	314						•
	316						•
 S.210  S.215  S.240A  S.120A  S.110  S.236  S.237  S.234  S.141A		•	•	•	•	•	•
		•	•	•	•	•	•
		•	•	•	•	•	•
			•	•	•	•	•
							•
							•
							•
							•
 PL.415  BP.112 389x164x66 mm 2,43 Kg	PL.702	PL.702	PL.702	PL.702	PL.702	PL.702	PLT.11, PL.23, PL.24A
	BP.109	BP.109	BP.109	BP.109	BP.109	BP.109	BT.108
	478x234x72 mm	478x234x72 mm	478x234x72 mm	478x234x72 mm	478x234x72 mm	478x234x72 mm	452x284x111 mm
	5,18 Kg	5,13 Kg	5,13 Kg	5,13 Kg	5,13 Kg	5,13 Kg	13,03 Kg

**S.420AU**



**S.441AUP  
S.440AUP**



**SL.441AUP  
SL.440AUP**













**S.450UP**



# 1/2" SOCKETS SETS

## STANDARD SETS

		S.401A	S.400A	S.405E	S.404E	STM.J9	AMEX.3
 TORX®						-	-
Socket type		Standard	Standard	Long	Long	Hexagonal screwdriver socket	TORX®
	8	•	•				
	9	•	•				
	10	•	•				
	11	•	•				
	12	•	•	•	•		
	13	•	•	•	•		
	14	•	•	•	•		
	15	•	•	•	•		
	16	•	•	•	•		
	17	•	•	•	•		
	18	•	•	•	•		
	19	•	•	•	•		
	21	•	•	•	•		
	22	•	•	•	•		
23	•	•	•	•			
24	•	•	•	•			
26	•	•	•	•			
27	•	•	•	•			
28	•	•	•	•			
29	•	•	•	•			
30	•	•	•	•			
32	•	•	•	•			
	STM.5					•	
	STM.6					•	
	STM.7					•	
	STM.8					•	
	STM.10					•	
	STM.12					•	
	STM.14					•	
	STM.17					•	
STM.19					•		
	SXM.20						•
	SXM.25						•
	SXM.27						•
	SXM.30						•
	SXM.40						•
	SXM.45						•
	SXM.50						•
	SXM.55						•
SXM.60						•	
		PL.413 BP.112 389 x 164 x 66 mm 2,69 Kg		PL.52B BP.109 478 x 234 x 72 mm 4,65 Kg		PL.458 BP.102 204 x 122 x 52 mm 0,865 Kg	PL.455

S.401A  
S.400A



S.405E  
S.404E









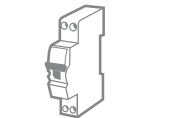
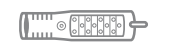
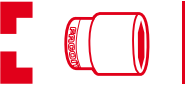



STM.J9



AMEX.3



# 1/2" SOCKETS SETS IN METALLIC RACK

			<b>S.40E</b>	<b>S.41E</b>	<b>S.40U</b>	<b>S.41U</b>	<b>STX.40</b>	<b>RSX.J6</b>	
							TORX	TORX	
Socket type		Standard	Standard	Standard	Standard	Standard	Standard	Standard 1/4" + 1/2"	
 mm	7								
	8	•							
	9	•							
	10	•							
	11	•							
	12	•							
	13	•							
	14	•							
	15	•							
	16	•							
	17			•					
	18			•					
	19			•					
	21			•					
	22			•					
	23			•					
24			•						
 "	3/8			•					
	7/16			•					
	1/2			•					
	9/16			•					
	19/32			•					
	5/8			•					
	21/32			•					
	11/16				•				
	3/4				•				
	13/16				•				
	7/8				•				
	15/16				•				
1"				•					
TORX®	E.6							•	
	E.8							•	
	E.10							•	
	E.12					•		•	
	E.14					•		•	
	E.16					•		•	
	E.18					•			
	E.20					•			
		CKS.95	CKS.95	CKS.97	CKS.95	CKS.90	CKS.98		
		0,570 Kg	0,69 Kg	0,465 Kg	0,350 Kg	0,320 Kg	0,205 Kg		

**S.40E**  
**S.41E**  
**S.40U**  
**S.41U**







**STX.40**



**RSX.J6**



# 1/2" SOCKETS SETS IN METALLIC RACK

		ST.40	ST.41	SX.41	SV.40A	SV.41A	SV.J8A	SV.LJ6A
<b>Screwdriver socket</b>								
 STM	STM.6	•						
	STM.8	•						
	STM.10	•						
	STM.12	•						
	STM.14	•						
	STM.17	•						
	STM.19	•						
 SXM	SXM.20			•				
	SXM.25			•				
	SXM.27			•				
	SXM.30			•				
	SXM.40			•				
	SXM.45			•				
	SXM.50			•				
	SXM.55			•				
SHPLA: long screwdriver socket for countersunk hex head screws	SHPLA.6		•					
	SHPLA.7		•					
	SHPLA.8		•					
	SHPLA.10		•					
	SHPLA.12		•					
SVLB: long screwdriver socket with multiple XZN teeth	SV.6LB						•	•
	SV.8LB					•	•	•
	SV.10LB					•	•	•
	SV.12LB					•	•	•
SVB: long screwdriver socket with multiple XZN teeth	SV.6B				•		•	
	SV.8B				•		•	
	SV.10B				•		•	
	SV.12B				•		•	
Extra-long screwdriver socket with multiple XCN teeth	SV.10ELB							•
	SV.12ELB							•
 	CKS.97	CKS.90	CKS.95	CKS.90		PL.247	PL.258	
						220x136x28 mm	170x170x34 mm	
	0,830 Kg	0,61 Kg	0,64 Kg	0,34 Kg	0,44 Kg	0,805 Kg	0,80 Kg	

ST.40



ST.41



SX.41



SV.40A  
SV.41A



SV.J8A





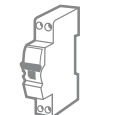
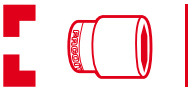







SV.LJ6A



# 1/2" MODULES IN THERMOFORMED TRAYS

## METRIC-INCH

		MOD.SL1	MOD.S1	MOD.S2	MOD.HLA	
		SL.161	S.161	S.161		
 12 6		6	6	12	6	
 1/4" 6.35 mm		Standard	Standard	Standard	Long	Long
	3/8			•		
	7/16			•		
	1/2			•		
	9/16			•		
	19/32			•		
	5/8			•		
	21/32			•		
	11/16			•		
	3/4			•		
	25/32			•		
	13/16			•		
	7/8			•		
	15/16					
	31/32					
	1					
	1'1/16					
1'1/8						
1'1/4						
	7					•
	8					•
	9					•
S.10H	S.10H	•	•			•
	S.11H	•	•		1/2	•
	S.12H	•	•		•	3/8
	S.13H	•	•		•	
	S.14H	•	•		•	
	S.15H	•	•		•	
	S.16H	•	•		•	
	S.17H	•	•		•	
	S.18H	•	•		•	
	S.19H	•	•		•	
	S.21H	•	•			
	S.22H	•	•			
S.23H	•	•				
S.24H	•	•				
S.27H	•	•				
S.30H	•	•				
S.32H	•	•				
	S.210	•	•	•		
	S.215	•	•	•		
	S.240A	•	•	•		
	S.120A					
	S.236					
	S.232B	•				
	S.230	•				
	PL.687	PL.323	PL.604	PL.609		
	435x198x55 mm	420x180x55 mm	420x180x55 mm	420x180x55 mm		
	3,36 Kg	3,32 Kg	2,95 Kg	1,62 Kg		

MOD.SL1



MOD.S1















MOD.S2



MOD.HLA



# 1/2" MODULES IN THERMOFORMED TRAYS

		MOD.TX1		MOD.CH	MOD.SHP
		TORX® JTX Standard	TORX® STX Standard	TORX® + XZN screwdriver socket Standard + Long	TORX® + XZN screwdriver socket Long
  other	D.34B7L			•	
	D.34B9L			•	
	D.34B10L			•	
	D.34B12L			•	
	D.34B14L			•	
	D.34B16L			•	
 JTX 3/8"	JTX.8	•		•	
	JTX.10	•		•	
	JTX.12	•			
	JTX.14	•			
	JTX.16	•			
SHP: countersunk hex long screwdriver	SHP.5LA				•
	SHP.6LA			•	•
	SHP.7LA				•
	SHP.8LA			•	•
	SHP.10LA			•	
  STX	STX.12			•	
	STX.14			•	
	STX.16			•	
	STX.18	•		•	
	STX.20	•		•	
SVB: long screwdriver socket with multiple teeth	SV.6LB			•	•
	SV.8LB			•	•
	SV.10ELB			•	•
	SV.12ELB			•	•
	SV.14ELB			•	•
SX: screwdriver socket for TORX®	SX.40LA				•
	SX.45LA				•
	SX.55LA			•	•
	SX.70LA			•	•
  EXR	10	•			
	15	•			
	20	•			
	25	•			
	30	•			
  EX	40	•			
	45	•			
	50	•			
	55	•			
59TX : TORX®	6x8	•			
	10x12	•			
	14x18	•			
	20x27	•			
 	R.235	•			
	S.236	•			
	J.235	•			
		PL.360		PL.663	PL.336
		420 x 180 x 55 mm			
		0,99 Kg			

MOD.TX1







MOD.CH

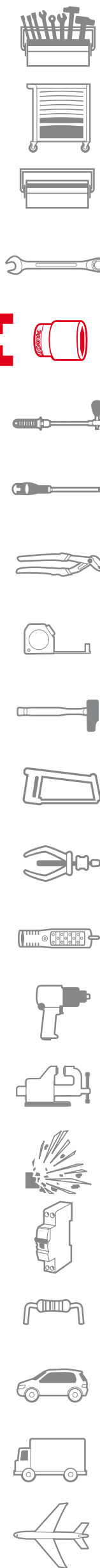

MOD.SHP

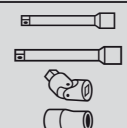

# 1/2" MODULES IN BI-COLOUR FOAM TRAYS

		MODM.SL1	MODM.S1A	MODM.HLA
		SL.161	S.161	-
		6	6	6
Type		Std	Std	Long
 mm	8	•	•	3/8"+1/2"
	9			
	10	•	•	
	11	•	•	
	12	•	•	
	13	•	•	
	14	•	•	
	15	•	•	
	16	•	•	
	17	•	•	
	18	•	•	
	19	•	•	
	20			
	21	•	•	
	22	•	•	
	23	•	•	
	24	•	•	
	27	•	•	
	28			
	29			
	30	•	•	
	32	•	•	
34				
Long-reach sockets 1/2"	S.12HLA			•
	S.13HLA			•
	S.14HLA			•
	S.15HLA			•
	S.16HLA			•
	S.17HLA			•
	S.18HLA			•
S.19HLA			•	
Long-reach sockets 3/8"	J.7HLA			•
	J.8HLA			•
	J.9HLA			•
	J.10HLA			•
	J.11HLA			•
	S.210	•	•	
	S.215	•	•	
	S.240A	•	•	
	S.120A	•	•	
		PM.S1A	PM.S1A	PM.MODHLA
		420 x 190 x 55 mm		
		3,40 Kg	3,45 Kg	

**MODM.SL1**

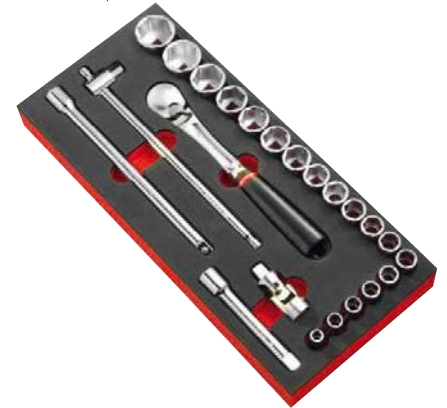

**MODM.S1A**



**MODM.HLA**



### Ratchets 1/2"

#### 1/2" maintenance free pear head ratchet

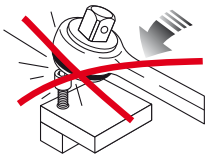
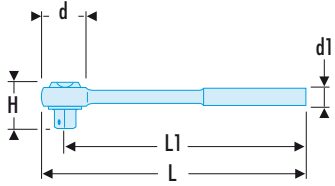

NF ISO 3315, ISO 3315, DIN 3122, ASME B107.10

- Dust proof, maintenance free mechanism.
- 72 teeth mechanism for 5° increments.
- Drive direction switch allows easy reversal even with gloved or greasy hands.
- Palm control system - allows the operator to press down on the head avoiding risk of accidental reverse
- Ultra-compact head.
- Hook for hanging when working at height.
- Ergonomic comfort grip handle design resistant to workshop chemicals and solvents.

➤	d [mm]	d1 [mm]	H [mm]	L [mm]	L1 [mm]	ΔΔ [g]
<b>SL.161</b>	37	32	37	262	245	446

#### 1/2" fast action twist handle ratchet

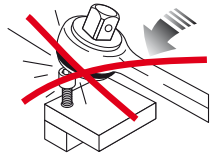
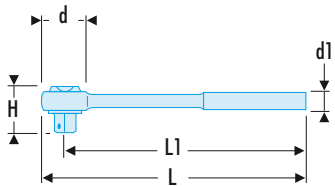

NF ISO 3315, ISO 3315, DIN 3122, ASME B107.10

- Rotating handle jack: work twice as fast in confined spaces.
- 6° increments for final tightening.
- Socket safety locking = no sockets lost in your machines.
- Palm control system - allows the operator to press down on the head avoiding risk of accidental reverse.

➤	d [mm]	d1 [mm]	H [mm]	L [mm]	L1 [mm]	ΔΔ [g]
<b>S.360</b>	45	37	41	251	251	570

#### 1/2" palm control ratchet

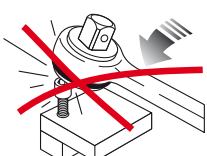
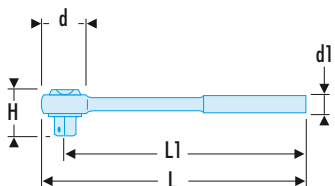

NF ISO 3315, ISO 3315, DIN 3122, ASME B107.10

- 72 teeth mechanism for 5° increments.
- Palm control system - allows the operator to press down on the head avoiding risk of accidental reverse.
- Ring reversing.

➤	d [mm]	d1 [mm]	H [mm]	L [mm]	L1 [mm]	ΔΔ [g]
<b>S.161</b>	39	31	43	250	234	500

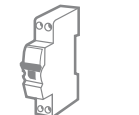
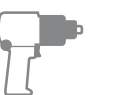
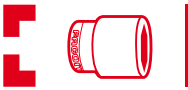



## Standard 1/2" ratchet

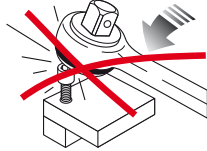
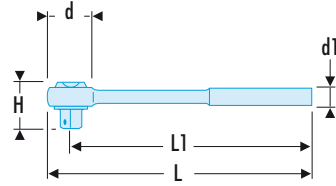

NF ISO 3315, ISO 3315, DIN 3122, ASME B107.10

- 72 teeth mechanism for 5° increments.
- Reversing by rotating cap.

🔧	d [mm]	d1 [mm]	H [mm]	L [mm]	L1 [mm]	ΔΔ [g]
<b>S.151</b>	39	30	40	250	255	480

## 1/2" locking ratchet

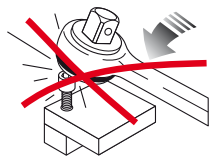
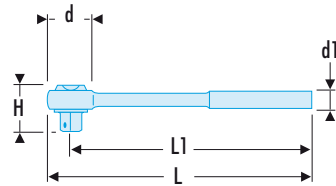

NF ISO 3315, ISO 3315, DIN 3122, ASME B107.10

- 72 teeth mechanism for 5° increments.
- Palm control system - allows the operator to press down on the head avoiding risk of accidental reverse.
- Ring reversing.
- Socket safety locking = no sockets lost in your machines.

🔧	d [mm]	d1 [mm]	H [mm]	L1 [mm]	L2 [mm]	ΔΔ [g]
<b>S.171</b>	39	31	44	250	234	510

## Long-reach 1/2" ratchet

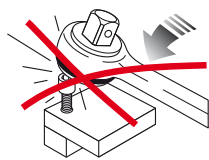
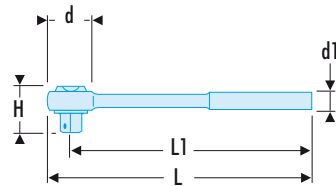

- 72 teeth mechanism for 5° increments.
- Reversing by rotating cap.
- Length: 400 mm (applies more torque and reduces effort).

🔧	d [mm]	d1 [mm]	H [mm]	L [mm]	L1 [mm]	ΔΔ [g]
<b>S.154</b>	40	30	40	404	38	780

## Hinged 1/2" ratchet

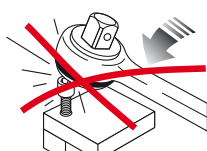
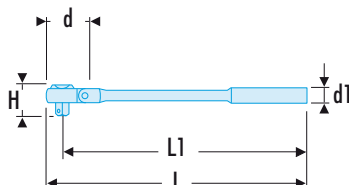

- 72 teeth mechanism for 5° increments.
- Palm control system - allows the operator to press down on the head avoiding risk of accidental reverse.
- Ring reversing.
- Stiffened joint to maintain the position even with an extension and the socket engaged.

🔧	d [mm]	d1 [mm]	H [mm]	L [mm]	L1 [mm]	ΔΔ [g]
<b>S.143A</b>	38	31	42	265	247	598

Long-reach 1/2" hinged ratchet

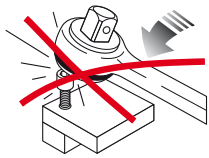
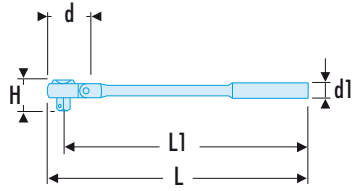

- 72 teeth mechanism for 5° increments.
- Palm control system - allows the operator to press down on the head avoiding risk of accidental reverse.
- Ring reversing.
- Extra-long handle to apply more torque without effort.
- Stiffened joint to maintain the position even with an extension and the socket engaged.

🔧	d [mm]	d1 [mm]	H [mm]	L [mm]	L1 [mm]	ΔΔ [g]
<b>S.153A</b>	38	31	43	400	381	755

Long hinged metal grip 1/2" ratchet

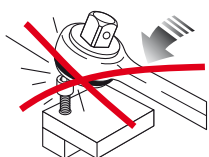
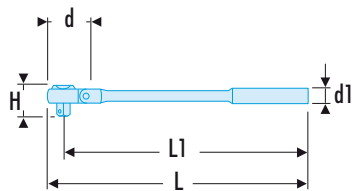

- 72 teeth mechanism for 5° increments.
- Palm control system - allows the operator to press down on the head avoiding risk of accidental reverse.
- Ring reversing.
- Extra-long handle to apply more torque without effort.
- Stiffened joint to maintain the position even with an extension and the socket engaged.
- Full metal grip.

🔧	d [mm]	d1 [mm]	H1 [mm]	L [mm]	ΔΔ [g]
<b>S.158A</b>	42	20		435	940

1/2" offset ratchet

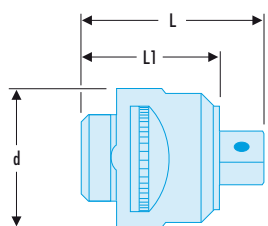

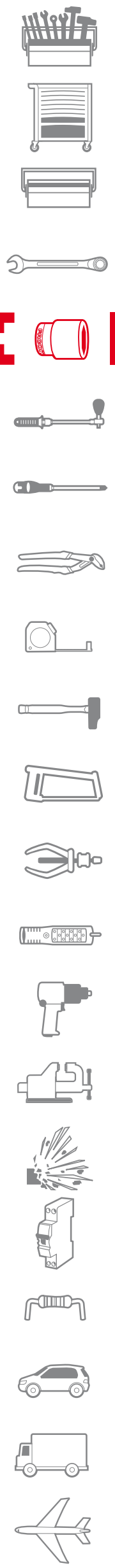

- Female square drive bit 1/2".
- Male square drive bit 1/2".
- Increment: 5°.
- Finish: bright chrome with phosphate-hardened square drive.

🔧	d [mm]	L [mm]	L1 [mm]	ΔΔ [g]
<b>S.156</b>	39	59	39	230



MAINTENANCE OF 1/2" RATCHETS

	S.171	S.161	S.151	S.154	S.143A	S.153A	S.158A	S.156
<b>Caps</b>								
 S.161C		•			•	•	•	
S.151C			•	•				
S.156C								•
<b>Spare part kit</b>								
 S.161RN		•			•	•	•	
S.151RN			•	•				•
<b>Rotors</b>								
 S.151R		•	•	•	•	•	•	•

Accessories 1/2"

1/2" drive sliding tee

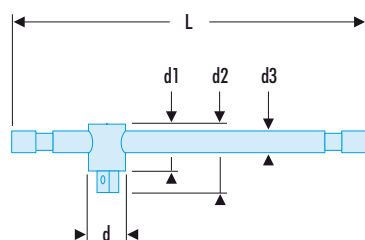

NF ISO 3315, ISO 3315, DIN 3122, ASME B107.10

- Friction-head allows bar to form a T or L-handle.
- Finish: bright chrome.

	d [mm]	d1 [mm]	d2 [mm]	d3 [mm]	L [mm]	ΔΔ [g]
<b>S.120A</b>	24	29	45	14	275	408

1/2" drive hinged handle

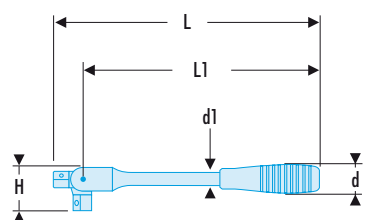

NF ISO 3315, ISO 3315, DIN 3122, ASME B107.10

- Stiffened joint.
- Finish: bright chrome.

	d [mm]	d1 [mm]	H [mm]	L [mm]	L1 [mm]	ΔΔ [g]
<b>S.140A</b>	31	14	44	246	214,5	425

1/2" long drive hinged handle

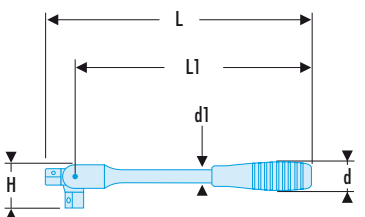

NF ISO 3315, ISO 3315, DIN 3122, ASME B107.10

- Stiffened joint.
- Finish: bright chrome.

	d [mm]	d1 [mm]	H [mm]	L [mm]	L1 [mm]	ΔΔ [g]
<b>S.141A</b>	31	14	41	381	349,5	595

1/2" drive metal-grip hinged handle

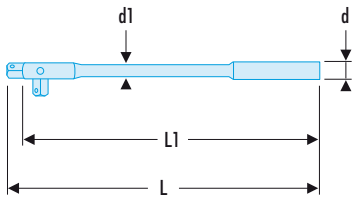

NF ISO 3315, ISO 3315, DIN 3122, ASME B107.10

- Stiffened joint.
- Metal handle with knurled handle.
- Finish: bright chrome.

➤	d [mm]	d1 [mm]	L [mm]	L1 [mm]	ΔΔ [g]
<b>S.145</b>	20	15	410	392	740

1/2" drive speed brace

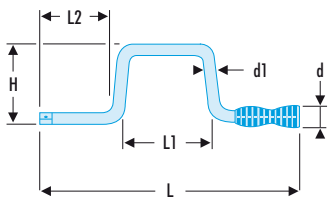

NF ISO 3315, ISO 3315, DIN 3122, ASME B107.10

- Significant time-savings whenever space allows.
- PVC rotating handle.
- Finish: bright chrome.

➤	d [mm]	d1 [mm]	H [mm]	L [mm]	L1 [mm]	L2 [mm]	ΔΔ [g]
<b>S.110</b>	29	12	115	402	130	130	510

1/2" drive tee with universal joint

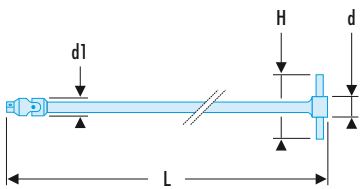

- Universal joint for high torques.
- Finish: bright chrome.

➤	d [mm]	d1 [mm]	H [mm]	L [mm]	ΔΔ [g]
<b>S.229A</b>	18	24	180	495	550

1/2" extra-long drive tee with universal joint

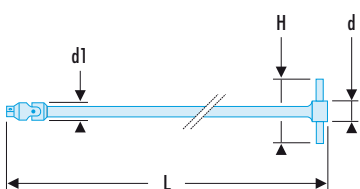

- Extended reach of tee-handle is ideal for particularly deep recesses.
- Finish: bright chrome.

➤	d [mm]	d1 [mm]	H [mm]	L [mm]	ΔΔ [kg]
<b>S.228</b>	24	25	240	700	1,20

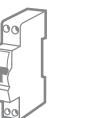
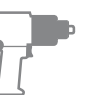
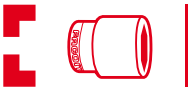
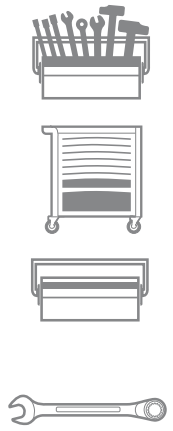

## ■ S - 1/2" drive extensions

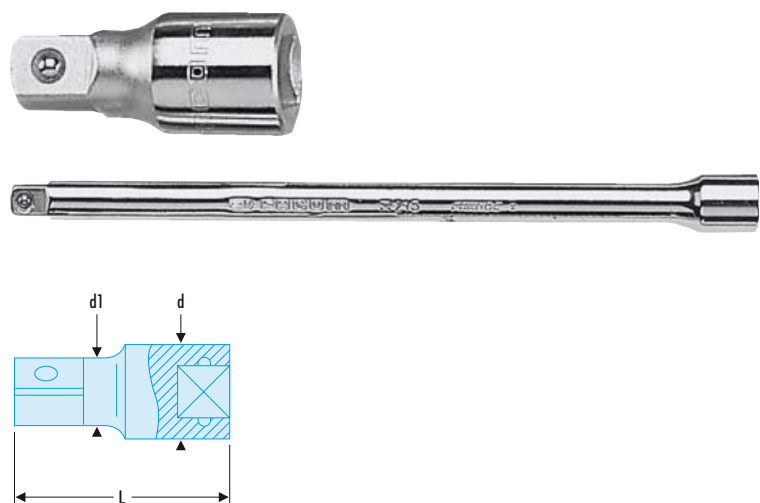

NF ISO 3316, ISO 3316, DIN 3123, ASME B107.10

- Finish: bright chrome.

☞	Square ["]	d [mm]	d1 [mm]	L [mm]	ΔΔ [g]
<b>S.206</b>	1/2	23	16,5	52,5	90
<b>S.208</b>	1/2	23	16,5	75	130
<b>S.210</b>	1/2	23	16,5	130	225
<b>S.215</b>	1/2	23	16,5	250	420
<b>S.217</b>	1/2	23	16,5	500	840

## ■ S.S - 1/2" wobble drive extensions

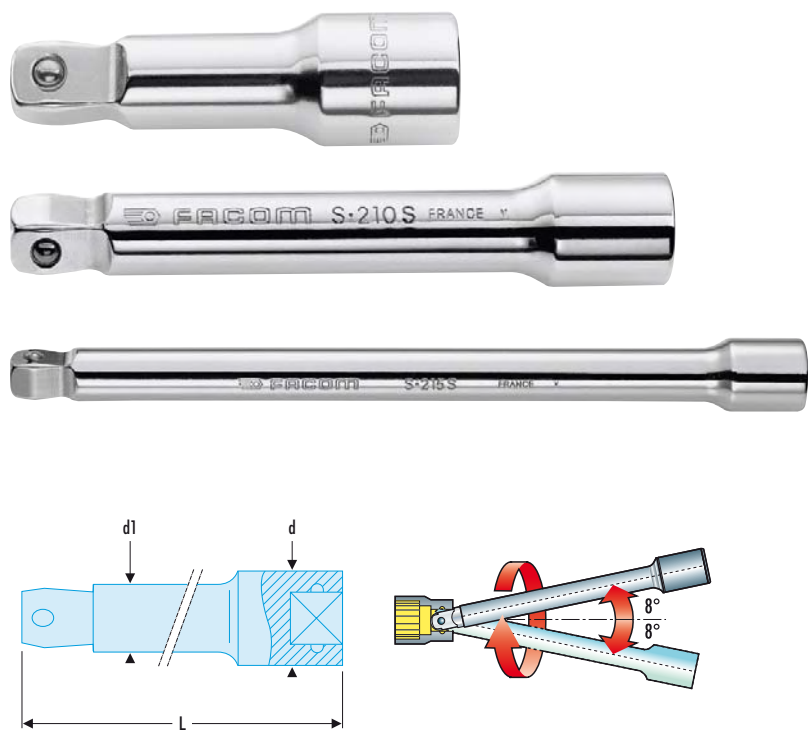

- Square drive rounded profile gives 8° working angle.
- Useful where access is limited.
- Finish: bright chrome.

☞	Square ["]	d [mm]	d1 [mm]	L [mm]	ΔΔ [g]
<b>S.208S</b>	1/2	23	16,5	75	130
<b>S.210S</b>	1/2	23	16,5	130	225
<b>S.215S</b>	1/2	23	16,5	250	420

## WOBBLE EXTENSION

Hard to access with a socket or universal joint? USE A WOBBLE EXTENSION !

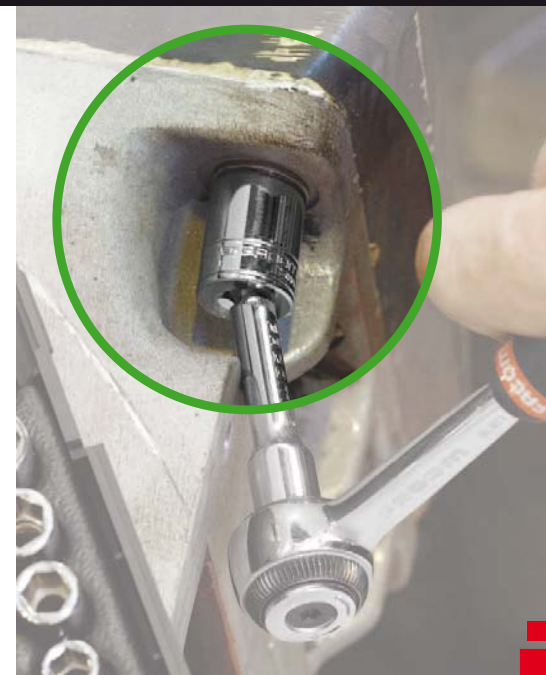
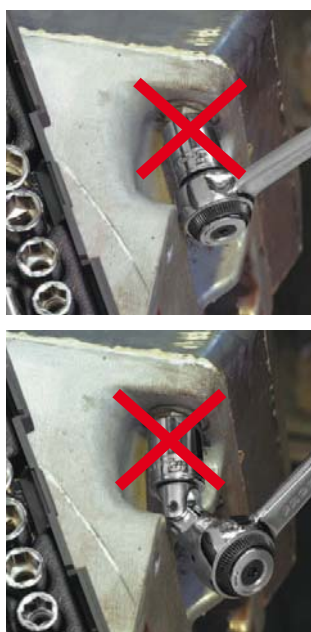
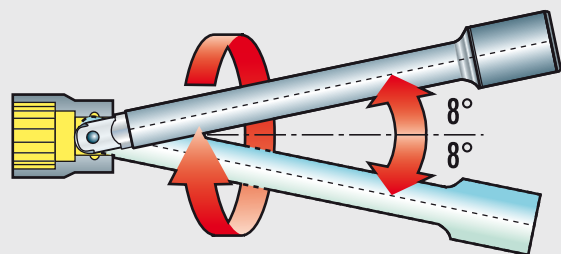

**S.RC - 1/2" drive locking extensions**

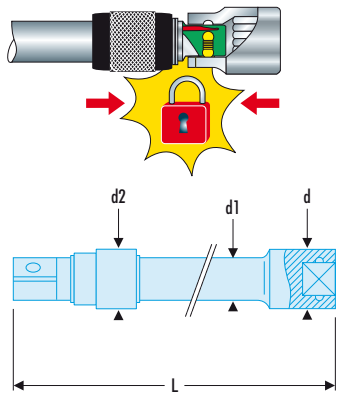

NF ISO 3316, ISO 3316, DIN 3123, ASME B107.10

- Total safety as lock system prevents socket loss.
- Safety and instant release, by retracting knurled ring, for total user confidence.
- Positive locking for use with sockets with internal ball notch.
- Finish: bright chrome with phosphate-hardened ring.

☞	Square ["]	d [mm]	d1 [mm]	d2 [mm]	E [mm]	L [mm]	ΔΔ [g]
<b>S.210RC</b>	1/2	23	16,5	23	16,5	130	250
<b>S.215RC</b>	1/2	23	16,5	23	16,5	250	450
<b>S.217RC</b>	1/2	23	16,5	23	16,5	500	860

**1/2" universal joint**

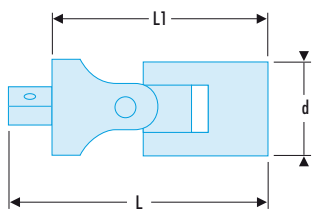

NF ISO 3316, ISO 3316, DIN 3123, ASME B107.10

- Spring-stiffened joint.
- Stays in position when reaching for fasteners.
- Significant time savings.
- Finish: bright chrome.

☞	d [mm]	L [mm]	L1 [mm]	ΔΔ [g]
<b>S.240A</b>	23	66	51	150

**1/2" to 3/8" coupler**

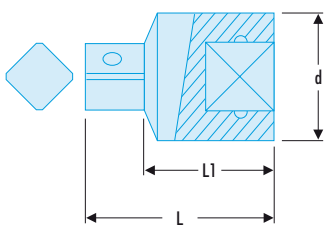

NF ISO 3316, ISO 3316, DIN 3123, ASME B107.10

- Double 3/8" coupler
- Max torque: 212 N.m.
- Finish: bright chrome.

☞	d [mm]	L [mm]	L1 [mm]	ΔΔ [g]
<b>S.230</b>	23	33,5	23	55

**1/2" to CDX® coupler**

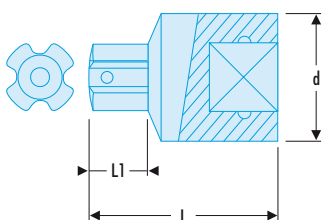

NF ISO 3316, ISO 3316, DIN 3123, ASME B107.10

- 1/2" female to CDX® male square drive.
- Double "CDX®" coupler.
- Finish: bright chrome.

☞	d [mm]	L [mm]	L1 [mm]	ΔΔ [g]
<b>S.231</b>	22	37	12	65

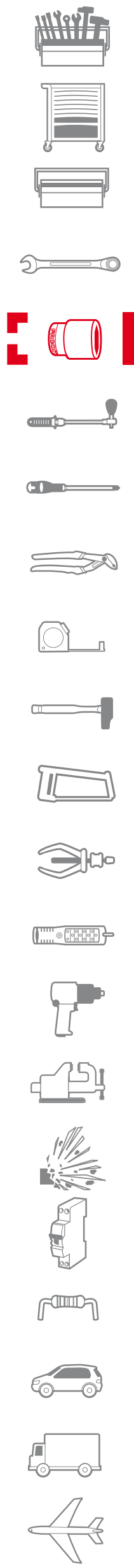

## 1/2" to 3/4" coupler

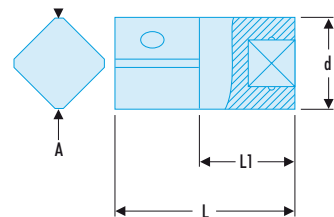

NF ISO 3316, ISO 3316, DIN 3123, ASME B107.10

- 1/2" female to 3/4" male square drive with plunger.
- For adapting sockets and accessories 3/4".
- Male square drive with plunger for positive locking of sockets and accessories.
- Finish: satin chrome.

Part	d [mm]	L [mm]	L1 [mm]	ΔΔ [g]
<b>S.232B</b>	25	49	26	135

## D.169 Set of 3 couplers



- Allows use of square drivers smaller than socket drive sizes:
    - 1/4" square drive + D.169RJ --> 3/8" socket.
    - 3/8" square drive + D.169JS --> 1/2" socket.
    - 1/2" square drive --> 3/4" socket.
  - Compactness means that fewer tools are needed for in situ maintenance operations.
  - Magnetic retainer and locking system (JS and SK).
  - Knurl allows hand tightening where access is difficult.
- Weight: 96 g.

## 1/2" drive offset adaptor

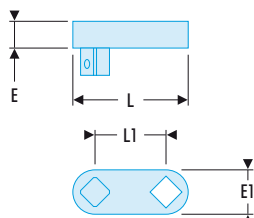

- 1/2" female to 1/2" male square drive.
- Offset centrelines for enhanced accessibility.
- Finish: bright chrome.
- S.236: for 5/16 bits.
- S.237: for 1/2 bits.

Part	E [mm]	E1 [mm]	L [mm]	L1 [mm]	ΔΔ [g]
<b>S.234</b>	15	25	65	40	165

## S - 1/2" drive spring-clip bit holders

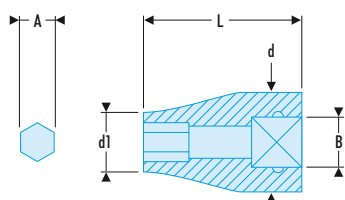

NF ISO 2725-1, NF ISO 1173, ISO 2725-1, ISO 1173, DIN 3124,

- S.236: for 5/16 bits.
- S.237: for 1/2 bits.
- Finish: bright chrome.

Part	A ["]	Vierkant ["]	d [mm]	d1 [mm]	L [mm]	ΔΔ [g]
<b>S.236</b>	5/16	1/2	23,0	14	36	54
<b>S.237</b>	1/2	1/2	23	20,5	44	70

## 1/2" drive lock-ring bit holder



NF ISO 2725-1, NF ISO 1173, ISO 2725-1, ISO 1173, DIN 3124,

- Bit lock.
- Square drive has side-hole for ball or plunger lock.

Part	A ["]	Square ["]	L [mm]	ΔΔ [g]
<b>EFS</b>	1/4	1/2	50	88

### Sockets 1/2"

#### ■ S.H - 1/2" metric 6-point sockets

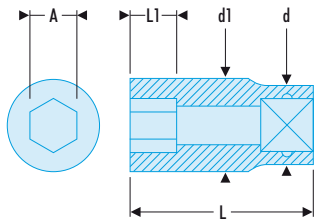

NF ISO 2725-1, NF ISO 1711-1, ISO 2725-1, ISO 1711-1, DIN 3124, ASME B107.5

- OGV® profile: more powerful tightening, preserves fasteners.
- Finish: bright chrome.

➤	A [mm]	⌀ [mm]	d [mm]	d1 [mm]	L [mm]	L1 [mm]	ΔΔ [g]
<b>S.8H</b>	8	6	22,8	13,1	36	6,5	48
<b>S.9H</b>	9	6	22,8	13,8	36	6,5	48
<b>S.10H</b>	10	6	22,8	15,3	36	7,8	48
<b>S.11H</b>	11	6	22,8	16,5	36	9,0	51
<b>S.12H</b>	12	6	22,8	17,8	36	9,5	52
<b>S.13H</b>	13	6	22,8	18,9	36	10,4	55
<b>S.14H</b>	14	6	22,8	20,2	36	10,5	57
<b>S.15H</b>	15	6	22,8	21,4	36	12,0	60
<b>S.16H</b>	16	6	21,6	22,6	36	12,0	57
<b>S.17H</b>	17	6	23,1	24,1	36	13,0	61
<b>S.18H</b>	18	6	23,4	25,5	36	13,0	68
<b>S.19H</b>	19	6	24,6	26,6	36	14,0	69
<b>S.20H</b>	20	6	25,4	27,4	36	14,0	71
<b>S.21H</b>	21	6	25,1	29,1	38	16,0	93
<b>S.22H</b>	22	6	26,4	30,4	38	16,5	101
<b>S.23H</b>	23	6	27,6	31,6	38	16,5	122
<b>S.24H</b>	24	6	28,7	32,7	38	16,5	130
<b>S.25H</b>	25	6	27,7	34,1	38	16,5	139
<b>S.26H</b>	26	6	29,0	35,4	38	16,5	149
<b>S.27H</b>	27	6	29,2	36,6	44	19,0	164
<b>S.28H</b>	28	6	30,5	37,9	44	20,0	175
<b>S.29H</b>	29	6	31,3	38,7	44	20,0	179
<b>S.30H</b>	30	6	33,0	40,4	44	20,0	201
<b>S.31H</b>	31	6	34,2	41,6	44	20,0	205
<b>S.32H</b>	32	6	35,1	42,6	44	20,0	215
<b>S.34H</b>	34	6	37,5	44,9	44	20,0	240

#### ■ S.H - 1/2" inch 6-point sockets

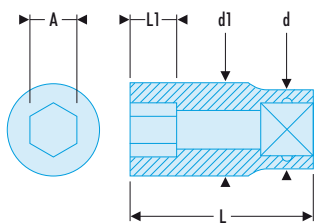

ASME B107.1

- OGV® profile: more powerful tightening, preserves fasteners.
- Finish: bright chrome.

➤	A ["]	⌀ [mm]	d [mm]	d1 [mm]	L [mm]	L1 [mm]	ΔΔ [g]
<b>S.3/8H</b>	3/8	6	22,8	14,7	36	7,8	48
<b>S.7/16H</b>	7/16	6	22,8	16,5	36	9,0	51
<b>S.1/2H</b>	1/2	6	22,8	18,9	36	10,4	55
<b>S.9/16H</b>	9/16	6	22,8	20,2	36	10,5	58
<b>S.19/32H</b>	19/32	6	22,8	21,4	36	12,0	60
<b>S.5/8H</b>	5/8	6	21,6	22,6	36	12,0	65
<b>S.21/32H</b>	21/32	6	23,1	24,1	36	13,0	65
<b>S.11/16H</b>	11/16	6	22,6	24,6	36	13,0	71
<b>S.3/4H</b>	3/4	6	25,0	27,0	36	14,0	68
<b>S.25/32H</b>	25/32	6	25,9	27,9	36	14,0	72
<b>S.13/16H</b>	13/16	6	24,6	28,6	38	16,0	96
<b>S.7/8H</b>	7/8	6	26,4	30,4	38	16,5	99
<b>S.15/16H</b>	15/16	6	28,7	32,7	38	16,5	132
<b>S.31/32H</b>	31/32	6	27,7	34,1	38	16,5	142
<b>S.1"H</b>	1	6	28,3	34,7	38	16,5	152
<b>S.1"1/16H</b>	1 1/16	6	29,2	36,6	44	19,0	164
<b>S.1"1/8H</b>	1 1/8	6	31,3	38,7	44	20,0	182
<b>S.1"3/16H</b>	1 3/16	6	33,0	40,4	44	20,0	201
<b>S.1"1/4H</b>	1 1/4	6	35,1	42,5	44	20,0	229





## ■ S - 1/2" metric 12-point sockets

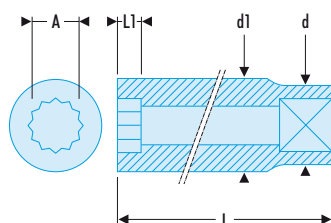

NF ISO 2725-1, NF ISO 1711-1, ISO 2725-1, ISO 1711-1, DIN 3124, ASME B107.5

- OGV® profile: more powerful tightening, preserves fasteners.
- Finish: bright chrome.
- Supplied on metal rack. Ref S.40E (8 --> 16 mm) and Ref S.41E (17 --> 24 mm).

➤	A [mm]	⚙ [mm]	d [mm]	d1 [mm]	L [mm]	L1 [mm]	ΔΔ [g]
<b>S.8</b>	8	12	22,8	13,1	36	6,5	48
<b>S.9</b>	9	12	22,8	13,8	36	6,5	48
<b>S.10</b>	10	12	22,8	15,3	36	7,8	48
<b>S.11</b>	11	12	22,8	16,5	36	9,0	51
<b>S.12</b>	12	12	22,8	17,8	36	9,5	52
<b>S.13</b>	13	12	22,8	18,9	36	10,4	55
<b>S.14</b>	14	12	22,8	20,2	36	10,5	57
<b>S.15</b>	15	12	22,8	21,4	36	12,0	60
<b>S.16</b>	16	12	21,6	22,6	36	12,0	57
<b>S.17</b>	17	12	23,1	24,1	36	13,0	61
<b>S.18</b>	18	12	23,4	25,4	36	13,0	68
<b>S.19</b>	19	12	24,6	26,6	36	14,0	69
<b>S.20</b>	20	12	25,4	27,4	36	14,0	71
<b>S.21</b>	21	12	25,1	29,1	38	16,0	93
<b>S.22</b>	22	12	26,4	30,4	38	16,5	101
<b>S.23</b>	23	12	27,6	31,6	38	16,5	122
<b>S.24</b>	24	12	28,7	32,7	38	16,5	130
<b>S.25</b>	25	12	27,7	34,1	38	16,5	128
<b>S.26</b>	26	12	29,0	35,4	38	16,5	138
<b>S.27</b>	27	12	29,2	36,6	44	19,0	142
<b>S.28</b>	28	12	30,5	37,9	44	20,0	163
<b>S.29</b>	29	12	31,3	38,7	44	20,0	167
<b>S.30</b>	30	12	33,0	40,4	44	20,0	185
<b>S.31</b>	31	12	34,2	41,6	44	20,0	189
<b>S.32</b>	32	12	35,1	42,5	44	20,0	198
<b>S.34</b>	34	12	37,5	44,9	44	20,0	223

## ■ S - 1/2" inch 12-point sockets

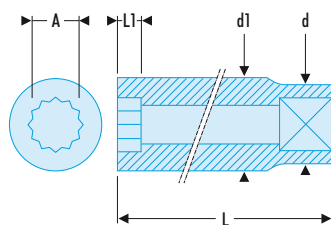

ASME B107.1

- OGV® profile: more powerful tightening, preserves fasteners.
- Finish: bright chrome.
- Available as rack set Ref S.40U (3/8" --> 21/32") and Ref S.41U (11/16" --> 1").

➤	A ["]	⚙ [mm]	d [mm]	d1 [mm]	L [mm]	L1 [mm]	ΔΔ [g]
<b>S.3/8</b>	3/8	12	22,8	14,7	36	7,8	48
<b>S.7/16</b>	7/16	12	22,8	16,5	36	9,0	51
<b>S.1/2</b>	1/2	12	22,8	18,9	36	10,4	55
<b>S.9/16</b>	9/16	12	22,8	20,2	36	10,5	58
<b>S.19/32</b>	19/32	12	22,8	21,4	36	12,0	60
<b>S.5/8</b>	5/8	12	21,6	22,6	36	12,0	65
<b>S.21/32</b>	21/32	12	23,1	24,1	36	13,0	65
<b>S.11/16</b>	11/16	12	22,6	24,6	36	13,0	71
<b>S.3/4</b>	3/4	12	25,0	27,0	36	14,0	68
<b>S.25/32</b>	25/32	12	25,9	27,9	36	14,0	72
<b>S.13/16</b>	13/16	12	24,6	28,6	38	16,0	96
<b>S.7/8</b>	7/8	12	26,4	30,4	38	16,5	99
<b>S.15/16</b>	15/16	12	28,7	32,7	38	16,5	132
<b>S.31/32</b>	31/32	12	27,7	34,1	38	16,5	131
<b>S.1'</b>	1	12	28,3	34,7	38	16,5	141
<b>S.1'1/16</b>	1 1/16	12	29,2	36,6	44	19,0	147
<b>S.1'1/8</b>	1 1/8	12	31,3	38,7	44	20,0	170
<b>S.1'3/16</b>	1 3/16	12	33,0	40,4	44	20,0	185
<b>S.1'1/4</b>	1 1/4	12	35,1	42,5	44	20,0	201

### ■ S.HLA - 1/2" long-reach metric 6-point sockets

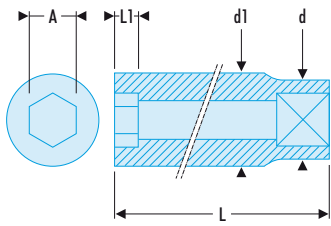

NF ISO 2725-1, NF ISO 1711-1, ISO 2725-1, ISO 1711-1, DIN 3124, ASME B107.5

- OGV® profile: more powerful tightening, preserves fasteners.
- Long-reach sockets for long recess or thread access.
- Finish: bright chrome.

➤	A [mm]	⌀ [mm]	d [mm]	d1 [mm]	L [mm]	L1 [mm]	ΔΔ [g]
S.12HLA	12	6	21	17,8	77	12	105
S.13HLA	13	6	21,8	19,0	77	12	115
S.14HLA	14	6	21,8	20,3	77	15	120
S.15HLA	15	6	21,8	21,5	77	15	125
S.16HLA	16	6	22,0	22,8	77	15	128
S.17HLA	17	6	23,0	24,0	77	15	140
S.18HLA	18	6	24,0	25,0	77	18	160
S.19HLA	19	6	25,0	26,5	77	18	160
S.21HLA	21	6	27,0	29,0	77	18	200
S.22HLA	22	6	28,0	30,0	77	21	215
S.23HLA	23	6	29,0	31,5	77	21	232
S.24HLA	24	6	30,0	32,8	77	24	255
S.26HLA	26	6	32,0	35,0	77	24	280
S.27HLA	27	6	33,0	36,5	77	27	310
S.28HLA	28	6	34,0	37,8	77	27	330
S.29HLA	29	6	35,0	39,0	77	27	355
S.30HLA	30	6	36,0	40,0	77	30	355
S.32HLA	32	6	38,0	42,8	77	33	408

### ■ S.LA - 1/2" long-reach metric 12-point sockets

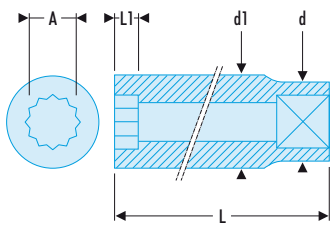

NF ISO 2725-1, NF ISO 1711-1, ISO 2725-1, ISO 1711-1, DIN 3124, ASME B107.5

- OGV® profile: more powerful tightening, preserves fasteners.
- Long-reach sockets for long recess or thread access.
- Finish: bright chrome.

➤	A [mm]	⌀ [mm]	d [mm]	d1 [mm]	L [mm]	L1 [mm]	ΔΔ [g]
S.12LA	12	12	21,0	17,8	77	12	105
S.13LA	13	12	21,8	19,0	77	12	115
S.14LA	14	12	21,8	20,3	77	15	125
S.15LA	15	12	21,8	21,5	77	15	125
S.16LA	16	12	22,0	22,8	77	15	135
S.17LA	17	12	23,0	24,0	77	15	145
S.18LA	18	12	24,0	25,0	77	18	160
S.19LA	19	12	25,0	26,5	77	18	180
S.21LA	21	12	27,0	29,0	77	18	210
S.22LA	22	12	28,0	30,0	77	21	215
S.23LA	23	12	29,0	31,5	77	21	240
S.24LA	24	12	30,0	32,8	77	24	255
S.26LA	26	12	32,0	35,0	77	24	280
S.27LA	27	12	33,0	36,5	77	27	315
S.28LA	28	12	34,0	37,8	77	27	340
S.29LA	29	12	35,0	39,0	77	27	365
S.30LA	30	12	36,0	40,0	77	30	365
S.32LA	32	12	36,0	42,8	77	33	415

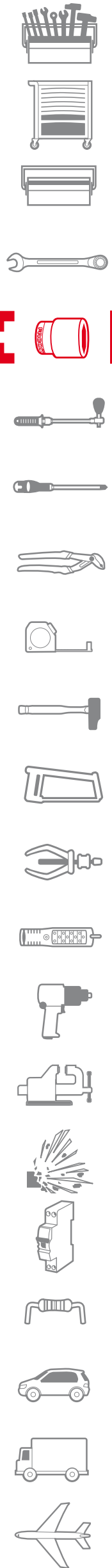

## ■ S.LA - 1/2" inch 12-point sockets

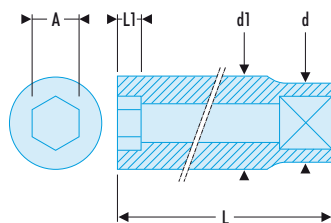

### ASME B107.1

- OGV® profile: more powerful tightening, preserves fasteners.
- Long-reach sockets for long recess or thread access.
- Finish: bright chrome.

➤	A ["]	⚙ [mm]	d [mm]	d1 [mm]	L [mm]	L1 [mm]	ΔΔ [g]
<b>S.1/2LA</b>	1/2	12	22,3	19,0	82,2	8,1	135
<b>S.9/16LA</b>	9/16	12	22,3	20,6	82,2	9,6	138
<b>S.5/8LA</b>	5/8	12	22,3	22,3	82,2	10,9	150
<b>S.11/16LA</b>	11/16	12	24,4	24,4	82,2	10,9	160
<b>S.3/4LA</b>	3/4	12	26,9	26,9	82,2	12,4	165
<b>S.13/16LA</b>	13/16	12	28,7	28,7	82,2	12,9	175
<b>S.7/8LA</b>	7/8	12	30,2	30,2	82,2	14,0	200
<b>S.15/16LA</b>	15/16	12	31,7	31,7	82,2	15,0	225
<b>S.1'LA</b>	1	12	33,3	33,3	82,2	15,2	255
<b>S.1'1/16LA</b>	1 1/16	12	36,5	36,5	82,2	16,0	320
<b>S.1'1/8LA</b>	1 1/8	12	38,1	38,1	82,2	16,7	350
<b>S.1'1/4LA</b>	1 1/4	12	42,9	42,9	82,2	16,7	430

## Torx® sockets 1/2"

### ■ STX - 1/2" Torx® sockets

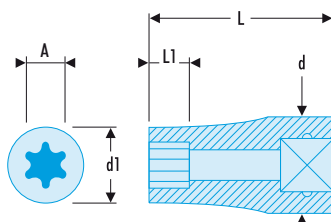

- For Torx® fasteners.
- Finish: bright chrome.
- Available as rack set Ref STX.40 (E12 --> E20) and Ref RSX.J6 (E6 --> E16).

➤	A [mm]	Torx [No]	d [mm]	d1 [mm]	L [mm]	L1 [mm]	ΔΔ [g]
<b>STX.12</b>	10,95	E12	21	15,0	37	8,0	47
<b>STX.14</b>	12,67	E14	21	16,3	37	8,8	47
<b>STX.16</b>	14,70	E16	22	18,8	37	9,6	57
<b>STX.18</b>	16,38	E18	22	20,4	37	11,1	57
<b>STX.20</b>	18,16	E20	22	22,9	37	12,7	63
<b>STX.24</b>	21,84	E24	22	26,5	37	16,1	97

## Screwdriver sockets 1/2"

### ■ STM - 1/2" drive metric hexagon bit sockets

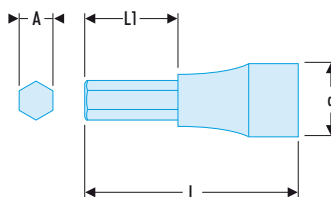

- Standard length series.
- For hexagon socket heads.
- Non-removable bit.
- Finish: bright chrome with phosphate-hardened tip.
- Available in case set (Ref STM.J9).

➤	A [mm]	d [mm]	L [mm]	L1 [mm]	ΔΔ [g]
<b>STM.4</b>	4	22,8	60	24	59
<b>STM.5</b>	5	22,8	60	24	60
<b>STM.6</b>	6	22,8	60	24	62
<b>STM.7</b>	7	22,8	60	24	64
<b>STM.8</b>	8	22,8	60	24	65
<b>STM.9</b>	9	22,8	60	24	70
<b>STM.10</b>	10	22,8	60	24	80
<b>STM.12</b>	12	23,1	60	24	102
<b>STM.14</b>	14	23,1	60	24	127
<b>STM.17</b>	17	23,4	60	24	152
<b>STM.19</b>	19	23,4	60	24	162

## ST - 1/2" drive inch hexagon bit sockets

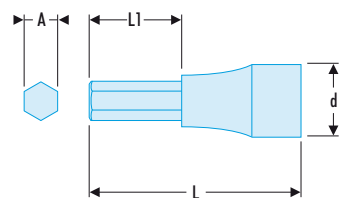

- Standard length series.
- For hexagon socket heads.
- Non-removable bit.
- Finish: bright chrome with phosphate-hardened tip.

➤	A ["]	d [mm]	Bits	L [mm]	L1 [mm]	ΔΔ [g]
<b>ST.1/4</b>	1/4	23	EH.201/4	54	17	67
<b>ST.5/16</b>	5/16	23	EH.205/16	54	17	67
<b>ST.3/8</b>	3/8	23	EH.203/8	54	17	74
<b>ST.7/16</b>	7/16	23	ENH.307/16	70	31	110
<b>ST.1/2</b>	1/2	23	ENH.301/2	70	31	117
<b>ST.9/16</b>	9/16	23	ENH.309/16	70	31	125
<b>ST.5/8</b>	5/8	23	ENH.305/8	70	31	143
<b>ST.3/4</b>	3/4	23	ENH.303/4	70	31	165

## SHP.LA - 1/2" drive long and extra-long reach metric hexagon bit sockets

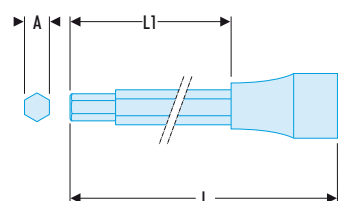

- Long and extra long reach series
- For hexagon socket heads.
- Non-removable bit.
- Finish: bright chrome with phosphate-hardened tip.

➤	A [mm]	L [mm]	L1 [mm]	ΔΔ [g]
<b>SHP.6LA</b>	6	100	64	77
<b>SHP.7LA</b>	7	100	64	78
<b>SHP.8LA</b>	8	100	64	79
<b>SHP.10LA</b>	10	140	104	132
<b>SHP.12LA</b>	12	100	64	144
<b>SHP.5ELA</b>	5	180	144	112
<b>SHP.6EL1A</b>	6	140	104	93
<b>SHP.6EL2A</b>	6	220	184	127

## SXM - 1/2" drive Torx® bit sockets

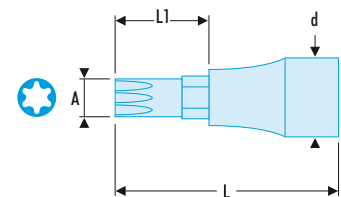

- Standard length series.
- For Torx® female drive fasteners.
- Non-removable bit.
- Finish: bright chrome with phosphate-hardened tip.
- Also available in case set (Ref AMEX.3).

➤	A [mm]	Torx [No]	d [mm]	L [mm]	L1 [mm]	ΔΔ [g]
<b>SXM.20</b>	3,84	T20	22,8	60	24	58
<b>SXM.25</b>	4,40	T25	22,8	60	24	58
<b>SXM.27</b>	4,96	T27	22,8	60	24	59
<b>SXM.30</b>	5,49	T30	22,8	60	24	59
<b>SXM.40</b>	6,60	T40	22,8	60	24	62
<b>SXM.45</b>	7,77	T45	22,8	60	24	63
<b>SXM.50</b>	8,79	T50	22,8	60	24	74
<b>SXM.55</b>	11,17	T55	22,8	60	24	96
<b>SXM.60</b>	13,17	T60	23,1	60	24	117

## SX.LA - 1/2" drive long-reach Torx® bit sockets

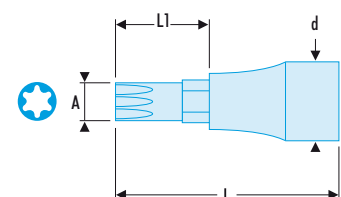

- Long-reach series.
- For Torx® female drive fasteners.
- Non-removable bit.
- Finish: bright chrome with phosphate-hardened tip.

➤	A [mm]	Torx [No]	d [mm]	L [mm]	L1 [mm]	ΔΔ [g]
<b>SX.40LA</b>	6,60	T40	22,8	120	84	95
<b>SX.45LA</b>	7,77	T45	22,8	120	84	95
<b>SX.55LA</b>	11,17	T55	22,8	140	104	220
<b>SX.70LA</b>	15,49	T70	23,1	140	104	280

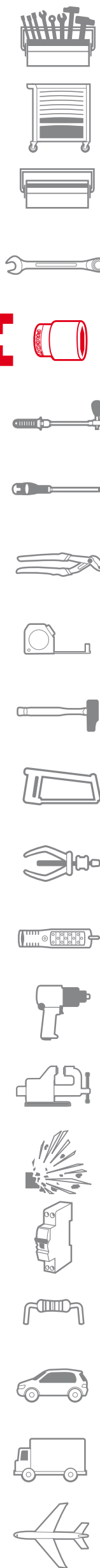

## ▣ D.B - Long-reach spline driver sockets

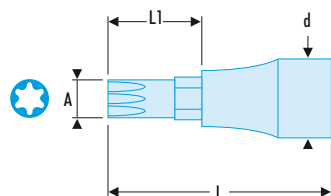

- Standard length series.
- For Torx® female drive fasteners.
- Non-removable bit.
- Finish: bright chrome with phosphate-hardened tip.

⇒	A [mm]	d [mm]	L1 [mm]	ΔΔ [g]
<b>D.34B7</b>	7	7	15	60
<b>D.34B7L</b>	7	7	63	100
<b>D.34B9L</b>	9	9	63	100
<b>D.34B10</b>	10	10	15	60
<b>D.34B12L</b>	12	12	63	100
<b>D.34B14L</b>	14	14	63	100
<b>D.34B16L</b>	16	16	63	100

## ▣ SV.B - 1/2" drive XZN® spline bit sockets

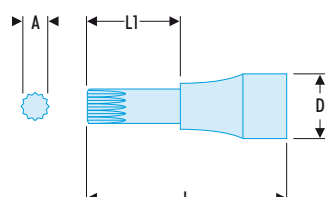

- Standard length series.
- For XZN® female drive fasteners.
- Non-removable bit.
- Finish: bright chrome with phosphate-hardened tip.

⇒	A [mm]	d [mm]	L [mm]	L1 [mm]	ΔΔ [g]
<b>SV.6B</b>	M6	22,8	60	24	60
<b>SV.8B</b>	M8	22,8	60	24	60
<b>SV.10B</b>	M10	22,8	60	24	70
<b>SV.12B</b>	M12	22,8	60	24	80
<b>SV.14B</b>	M14	22,8	60	24	100
<b>SV.16B</b>	M16	23,1	60	24	110

## ▣ SV.LB - 1/2" drive long-reach XZN® spline bit sockets

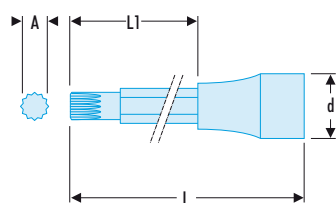

- Long and extra long reach series
- For XZN® female drive fasteners.
- Non-removable bit.
- Finish: bright chrome with phosphate-hardened tip.

⇒	A [mm]	d [mm]	L [mm]	L1 [mm]	ΔΔ [g]
<b>SV.6LB</b>	M6	22,8	100	64	80
<b>SV.8LB</b>	M8	22,8	100	64	80
<b>SV.10LB</b>	M10	22,8	100	64	90
<b>SV.10ELB</b>	M10	22,8	120	120	110
<b>SV.12LB</b>	M12	22,8	100	64	120
<b>SV.12ELB</b>	M12	22,8	140	104	150
<b>SV.14LB</b>	M14	22,8	100	64	150

## CREATE YOUR OWN BIT SOCKETS

### Screw bits



- Series 2  $\square$  5/16"
- Series 3  $\square$  1/2"

➔ See Section 7

### Impact bit holder $\square$ 1/2"



▣ **S.236**  
 $\square$  5/16"  
7.94 mm













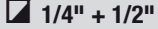

▣ **S.237**  
 $\square$  1/2"  
12.70 mm

➔ See p. 296



# MULTI-DRIVE SETS

## 1/4" + 1/2"

### 1/4" & 1/2" SOCKET SETS IN PLASTIC CASES

  		RS.100	RSL.100	RS.360
		R.161 + S.161	RL.161 + SL.161	R.360 + SL.161
		6	6	6
		STANDARD	STANDARD	STANDARD
 1/4"	R.5,5	•	•	•
	R.6	•	•	•
	R.7	•	•	•
	R.8	•	•	•
	R.9	•	•	•
	R.10	•	•	•
	R.11	•	•	•
 1/2"	R.12	•	•	•
	R.13	•	•	•
	S.10	•	•	•
	S.11	•	•	•
	S.12	•	•	•
	S.13	•	•	•
	S.14	•	•	•
 R.210	S.15	•	•	•
	S.17	•	•	•
	S.19	•	•	•
	S.21	•	•	•
	S.24	•	•	•
 R.240A	S.27	•	•	•
	R.240A	•	•	•
 S.210	S.210	•	•	•
	S.240A	•	•	•
 	BP.112			
	PL.404			
 	389 x 164 x 66 mm			
	2,630 kg	2,590 kg	2,640 kg	

### 1/4" & 1/2" SOCKET SETS IN METAL RACKS

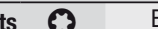
  		RSX.J6
		STANDARD
Sockets	E.6	1/4"
	E.8	1/4"
	E.10	1/4"
	E.12	1/2"
	E.14	1/2"
	E.16	1/2"
Rack		CKS.98
		0,205 kg

RS.100 ▼



RSL.100 ▼



RS.360 ▼



RSX.J6 ▼

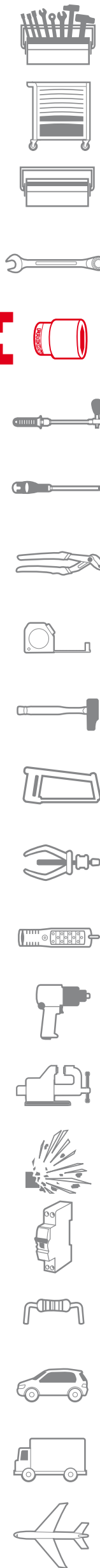

# MULTI-DRIVE SETS

## 1/4" + 1/2"

			<b>RS.440E</b>	<b>RS.430E</b>	<b>RSX.427P</b>	<b>RSX.19A</b>		
			R.161 + S.161	R.151 + S.151	R.161 + S.161	-		
		Socket type	Standard	Standard	Standard	Standard		
			1/4" + 1/2"	1/4" + 1/2"	1/4" + 1/2"	1/4" + 1/2"		
	1/4"	R.5	•	•				
		R.5.5	•	•				
		R.6	•	•				
		R.7	•	•				
		R.8	•	•				
		R.9	•	•				
		R.10	•	•				
		R.11	•	•				
		R.12	•	•				
		R.13	•	•				
		R.14	•	•				
			1/2"	SH.10	•	•		
				SH.11	•	•		
				SH.12	•	•		
SH.13	•			•				
SH.14	•			•				
SH.15	•			•				
SH.16	•			•				
SH.17	•			•				
SH.18	•			•				
SH.19	•			•				
SH.21	•			•				
SH.22	•			•				
SH.24	•	•						
SH.27	•	•						
SH.30	•	•						
SH.32	•	•						
	EP	1	•					
		2	•					
		3	•					
	ED	1	•					
		2	•					
		3	•					
	ES	4,5						
		6,5						
		8						
		10						
	EH	3	•					
		4	•					
		5	•					
		6	•					
		7	•					
		8	•					
			EXR	10	•			•
				15	•			•
20	•					•		
25	•					•		
27	•					•		
30	•					•		
STX: 1/2" Torx®	STX.12 STX.14 STX.16 STX.18 STX.20				•	•		
					•	•		
					•	•		
					•	•		
					•	•		
SXM: 1/2" Screwdriver for Torx® screws	27 30 40 45 50				•	•		
					•	•		
					•	•		
					•	•		
					•	•		
RTX: 1/4" Torx®	RTX.4 RTX.5 RTX.6 RTX.7 RTX.8 RTX.10				•	•		
					•	•		
					•	•		
					•	•		
					•	•		
Torx® bits	8 10 15 20 25 27 40 45 50 55				•	•		
					•	•		
					•	•		
					•	•		
					•	•		
					•	•		
					•	•		
					•	•		
					•	•		
					•	•		
	R.209 R.210 R.240A R.120A R.235 R.236A S.210S S.210 S.215 S.240A S.236 AMZ.H		•	•				
			•	•				
			•	•				
			•	•				
			•	•				
			•	•				
			•	•				
			•	•				
			•	•				
			•	•				
			•	•				
			•	•				
			•	•				
			•	•				
	PL.714 BP.109		PL.112A BP.109	PL.220B BP.112	PL.393A BP.102			
		478 x 234 x 72 mm	389 x 164 x 66 mm	204 x 122 x 52 mm				
			3,92 kg	2,20 kg	0,62 kg			

**RS.440E**



**RS.430E**



**RSX.427P**



















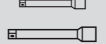

**RSX.19A**

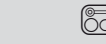
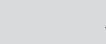
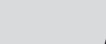

# MULTI-DRIVE SETS

## 1/2" + 3/4"

  			<b>SK.453N</b> K.151B + S.151  STANDARD	<b>SK.452N</b> K.151B + S.151  STANDARD	<b>SK.452U</b> K.151B + S.152  STANDARD
	3/4"	K.22HB			
		K.24HB	•	•	
		K.27HB	•	•	
		K.30HB	•	•	
		K.32HB	•	•	
		K.34HB	•	•	
		K.36HB	•	•	
		K.41HB	•	•	
		K.46HB	•	•	
		K.50HB	•	•	
	1/2"	SH.8	•	•	
		SH.9	•	•	
		SH.10	•	•	
		SH.11	•	•	
		SH.12	•	•	
		SH.13	•	•	
		SH.14	•	•	
		SH.15	•	•	
		SH.16	•	•	
		SH.17	•	•	
		SH.18	•	•	
		SH.19	•	•	
		SH.21	•	•	
		SH.22	•	•	
		SH.23	•	•	
		SH.24	•	•	
		SH.26	•	•	
		SH.27	•	•	
SH.28	•	•			
SH.29	•	•			
SH.30	•	•			
SH.32	•	•			
	3/4"	K.1"1/16			•
		K.1"1/2			•
		K.1"1/4			•
		K.1"1/8			•
		K.1"13/16			•
		K.1"3/5			•
		K.1"5/8			•
		K.1"7/16			•
		K.2"			•
					•
	1/2"	S.1"			•
		S.1/2			•
		S.11/16			•
		S.1"1/16			•
		S.1"1/4			•
		S.1"1/8			•
		S.13/16			•
		S.1"3/16			•
		S.15/16			•
		S.19/32			•
		S.21/32			•
		S.25/32			•
		S.3/4			•
		S.3/8			•
		S.31/32			•
		S.5/8			•
		S.7/16			•
		S.7/8			•
S.9/16			•		
         		K.120B	•	•	•
		K.210B	•	•	•
		K.215B	•	•	•
		S.210S			
		S.210	•	•	•
		S.215	•	•	•
		S.240A	•	•	•
		S.236			
		S.110	•	•	•
		S.120A	•	•	•
 			PL.21 BT.6A		PL.22 BT.6A
			468 x 190 x 160 mm		
			17,20 kg		16,2 kg

SK.453N



SK.452N



SK.452U

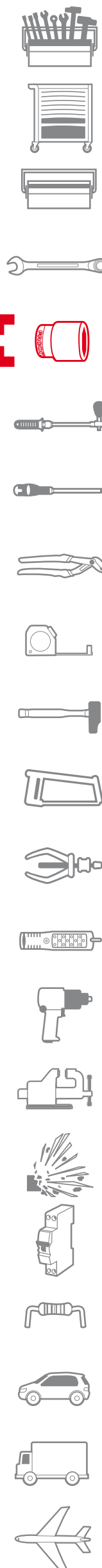











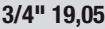



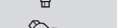
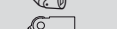

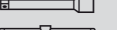
# 3/4" SOCKET SETS

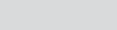
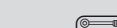
## METRIC DIMENSIONS

**FACOM, BY YOUR SIDE  
IN HEAVY MAINTENANCE  
WORK !**

		<b>K.411</b>	<b>K.441A</b>	<b>K.442E</b>	<b>K.437E</b>	<b>K.436E</b>	<b>SK.453N</b>		<b>SK.452N</b>	
		K.152	K.151B	K.151B	K.151B	K.151B	K.151B + S.151		K.151B + S.151	
		6	6	12	6	12	6	6	6	12
		K.HB	K.HB	K.B	K.HB	K.B	K.HB	S.H	K.B	S.
	mm									
	8									
	9									
	10									
	11									
	12									
	13									
	14									
	15									
	16									
	17									
	18									
	19		•	•	•	•	•			•
	21		•	•	•	•	•	3/4"	•	K.3/4"
	22		•	•	•	•	•	•	•	•
	23		•	•	•	•	•	•	•	•
	24		•	•	•	•	•	•	•	•
	26									
	27		•	•	•	•	•	•	•	•
28										
29										
30		•	•	•	•	•	•	•	•	
32		•	•	•	•	•	•	•	•	
34		•	•	•	•	•	•	1/2"	•	
36		•	•	•	•	•	•	•	•	
38			•	•						
41		•	•	•	•	•	•	•	•	
42										
46		•	•	•	•	•	•	•	•	
50		•	•	•	•	•	•	•	•	
54										
55		•	•	•	•	•			•	
	K.210B	•	•	•	•	•	•	•	•	
	K.215B	•	•	•	•	•	•	•	•	
	K.120B	•	•	•	•	•	•	•	•	
	K.240A		•	•						
	K.140A		•	•						
	K.125A		•	•						
	S.210						•		•	
	S.215						•		•	
	S.120A						•		•	
	S.240A						•		•	
	S.110						•		•	
	PL.438		C.K422CA + 2 x C.K422EA		PL.87A		P.21			
	BT.103G		BT.6A		BT.103G		BT.6A			
	643 x 230 x 111 mm		468 x 190 x 160 mm		643 x 230 x 111 mm		468 x 190 x 160 mm			
	15,20 kg		17,00 kg		15,50 kg		17,20 kg			

**K.411**



**K.437E  
K.436E**



**K.441A  
K.442E**



**SK.453N  
SK.452N**



# 3/4" SOCKETS SETS

## METRIC DIMENSIONS



FARMING EQUIPMENT MAINTENANCE



INDUSTRIAL MAINTENANCE



HGV MAINTENANCE

K.420N / K.421N



K.432E / K.433E



MOD.K2





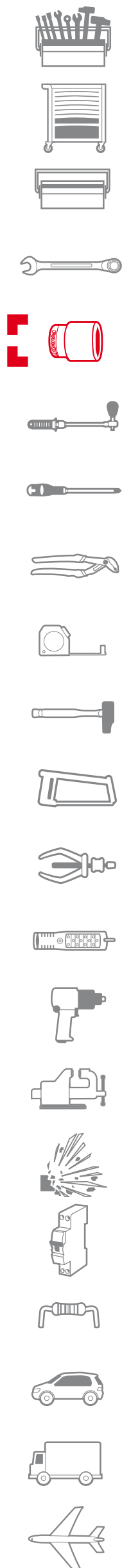







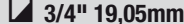







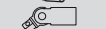

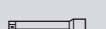
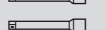
		<b>K.421N</b>	<b>K.420N</b>	<b>K.433E</b>	<b>K.432E</b>	<b>MOD.K2</b>	<b>MOD.K1</b>	<b>K.415E</b>	<b>K.405E</b>
  3/4" 19,05mm		K.151B	K.151B	K.151B	K.151B	K.152	K.151B	K.151B	-
		K.HB	K.B	K.HB	K.B	K.HB	K.HB	K.LA	K.LA
 mm	22	•	•					•	•
	23							•	•
	24	•	•					•	•
	26							•	•
	27	•	•					•	•
	29							•	•
	30	•		•	•			•	•
	32	•	•	•	•			•	•
	33			•	•			•	•
	34	•	•	•	•	•		•	•
	36	•	•	•	•	•	•	•	•
	38			•	•	•		•	•
	41	•	•	•	•	•		•	•
42			•	•	•		•	•	
46	•	•	•	•	•		•	•	
50	•	•	•	•	•		•	•	
54			•	•	•		•	•	
55			•	•	•		•	•	
      	K.210B	•	•	•	•	•	•	•	•
	K.215B	•	•	•	•	•	•	•	•
	K.120B	•	•	•	•	•	•	•	•
	K.240A								
	K.140A								
K.125A									
K.230B									
		PL.42 BT.103G		PL.40 BT.103G		PL.43	PL.60A	PL.43 BT.103G	PL.60A BT.111
		643 x 230 x 111 mm		643 x 230 x 111 mm				643 x 230 x 111 mm	396 x 224 x 82 mm
		12,90 kg	12,90 kg	16,30 kg	16,30 kg	7,46 kg	8,29 kg	16,27 kg	9,30 kg



# 3/4" SOCKET SETS

## INCH DIMENSIONS

    3/4" 19,05mm		K.442U	SK.452U	
		K.151B	K.151B + S.151	
		 K.B	 K.B	 S.
mm	3/8			•
	7/16			•
	1/2			•
	9/16			•
	19/32			•
	5/8			•
	21/32			•
	11/16			•
	3/4			•
	25/32			•
	13/16			•
	3/4	•		
	7/8	•		•
	15/16	•		•
	31/32			•
	1	•	3/4"	•
	1"1/16	•	•	•
	1"1/8	•	•	•
	1"1/4	•	•	•
	1"5/16	•		1/2"
	1"3/8	•	•	
	1"7/16	•	•	
	1"1/2	•	•	
	1"5/8	•	•	
	1"11/16	•		
	1"3/4	•		
	1"13/16	•	•	
	1"7/8	•		
	2"	•	•	
	2"1/8	•		
	2"3/16	•		
	2"1/4	•		
	K.210B	•	•	
	K.215B	•	•	
	K.120B	•	•	
	K.240A	•		
	K.140A	•		
	K.125A	•		
	S.210			•
	S.215			•
	S.120A			•
	S.240A			•
	S.110			•
	-		PL.22	
	BT.6A		BT.6A	
	468 x 190 x 160 mm		468 x 190 x 160 mm	
	22,1 kg		16,2 kg	



**K.442U**

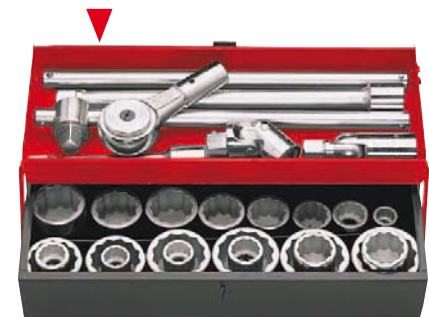

**SK.452U**

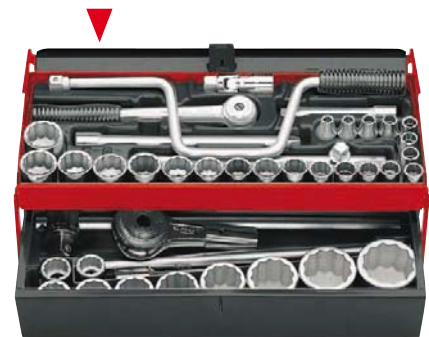

Ratchets 3/4"

K.152

COMPACT AND PRECISE RATCHET 3/4"

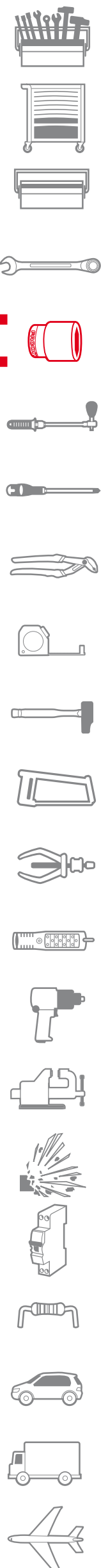

**25% MORE COMPACT FOR CONFINED SPACES !**

**ERGONOMIC**

- Ergonomic handle providing 2-handed grip for high torques.

**PERFORMANCE**

- Precise: 72 tooth mechanism, 5° manoeuvrable.
- Powerful and strong: 17 teeth in mesh during torquing.
- Monobloc ratchet: lighter and more manoeuvrable.
- Confined spaces: head 25% more compact than traditional ratchets.

**SAFETY FIRST**

- Plunger locks ratchet/sockets/accessories.



Compact and precise ratchet 3/4"

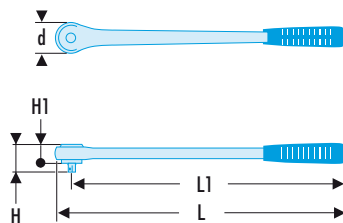

NF ISO 3315, ISO 3315, DIN 3122, ASME B107.10

- Monobloc ratchet: lighter and more manoeuvrable.
- Compact head.
- Ergonomic handle providing 2-handed grip for high torques.
- Precise increment: 5°.
- 72-tooth mechanism.
- Plunger lock.
- Finish: satin chrome.

	d [mm]	H [mm]	H1 [mm]	L [mm]	L1 [mm]	ΔΔ [kg]
<b>K.152</b>	62	56,5	32	505	474	1,67

# "Truck" 3/4" range

## 3/4" drive ratchet with removable handle

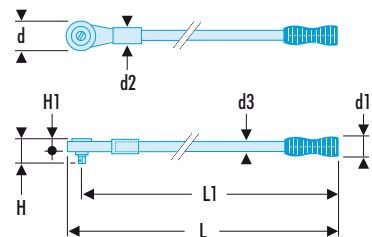

NF ISO 3315, ISO 3315, DIN 3122, ASME B107.10

- Precise increment: 5°.
- 72-tooth mechanism.
- Plunger lock.
- Finish: satin chrome.

	d	d1	d2	d3	H	H1	L	L1	$\Delta\Delta$
	[mm]	[mm]	[mm]	[mm]	[mm]	[mm]	[mm]	[mm]	[kg]
<b>K.154B</b>	69	40	30	20	61	37	548	514	2,40

## 3/4" drive ratchet without handle

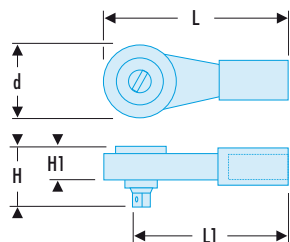

NF ISO 3315, ISO 3315, DIN 3122, ASME B107.10

- Precise increment: 5°.
- 72-tooth mechanism.
- For use with bars K.125 or K.126 and handle K.154AM.
- Plunger lock.
- Finish: chromed.
- Plastic grip ratchet handle K.151B.

	d [mm]	H [mm]	H1 [mm]	L [mm]	L1 [mm]	$\Delta\Delta$ [kg]
<b>K.151B</b>	68	60,8	36,6	170	136	1,20

## 3/4" drive "heavy duty" ratchet

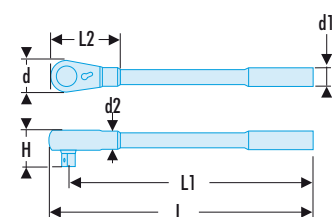





NF ISO 3315, ISO 3315, DIN 3122, ASME B107.10

- Suitable for outdoor working:
  - Sturdy mechanism protected against dirt.
  - Recessed reversing switch.
  - 9° increments.
  - 40 tooth mechanism.
  - Removable handle.
- Plunger lock.
- Finish: mat chrome.

	d [mm]	d1 [mm]	d2 [mm]	H [mm]	L [mm]	L1 [mm]	L2 [mm]	$\Delta\Delta$ [kg]
<b>K.149</b>	65,5	25	32	62	510	475	151	2,85

**MAINTENANCE OF 3/4" RATCHETS**

• Ratchet maintenance is straightforward: for continued serviceability, simply clean and replace worn parts periodically.

	K.150	K.150A	K.151	K.151A	K.151B	K.152	K.154A	K.154B	K.149
<b>Caps</b>									
 K.152C						•			
M.151C			•						
K.151BC				•	•		•	•	
<b>Spare part kit</b>									
 K.151RN			•	•	•		•	•	
K.152RN						•			
K.150RN	•	•							
<b>Rotors</b>									
 K.152R						•			
K.150R	•								
K.150AR		•							
K.151AR				•	•		•	•	
<b>Repair kit</b>									
 K.149RN									•

**Accessories 3/4"**

**K.154AM 3/4" drive sliding tee**



- Handle for 3/4" ratchets K.154B and K.151B.
- Plastic handle for enhanced comfort.

**K.A - Bar for 3/4" ratchet**

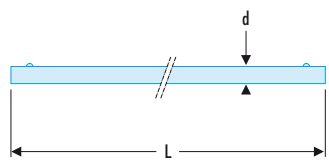

- For use as extension handles on ratchet K.151B, as well as on handles K.140A and K.200E.
- Finish: satin chrome.

	d [mm]	L [mm]	ΔΔ [kg]
<b>K.125A</b>	20	425	1,04
<b>K.126A</b>	20	500	1,22

**3/4" drive sliding tee**

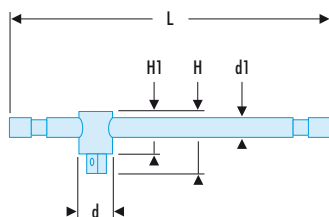

**NF ISO 3315, ISO 3315, DIN 3122, ASME B107.10**

- Ball-steadied head.
- T or L-handle.
- Finish: satin chrome.

	d [mm]	d1 [mm]	H [mm]	H1 [mm]	L [mm]	ΔΔ [kg]
<b>K.120B</b>	36	20	62	37	425	1,30



## 3/4" drive angle bar

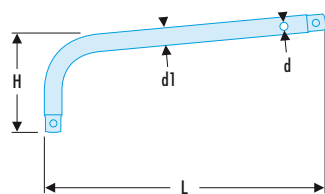

NF ISO 3315, ISO 3315, DIN 3122

- Takes 3/4" socket on either end:
- Short end for high torques.
- Long end for pre-tightening or in recess.
- Finish: satin chrome.

☞	d [mm]	d1 [mm]	H [mm]	L [mm]	ΔΔ [kg]
<b>K.130A</b>	8	25	85	540	2,30

## 3/4" drive fixed adaptor

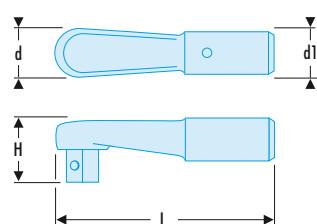

- For use with bars K.125 or K.126.
- For power loosening without damaging the ratchet.
- Finish: satin chrome.

☞	d [mm]	d1 [mm]	H [mm]	L [mm]	ΔΔ [g]
<b>K.200E</b>	35	30	40	152	630

## 3/4" drive hinged adaptor

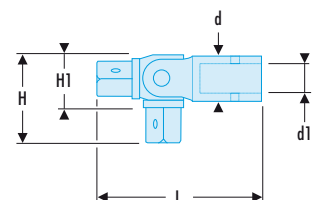

NF ISO 3315, ISO 3315, DIN 3122

- For use with bars K.125 or K.126.
- Fastener rotation from any angle over 180°.
- Joint 180°.
- Spring-steadied in any position.
- Finish: satin chrome.

☞	d [mm]	d1 [mm]	H [mm]	H1 [mm]	L [mm]	ΔΔ [g]
<b>K.140A</b>	40	20	70	46	125	760

## K.B - 3/4" drive extensions

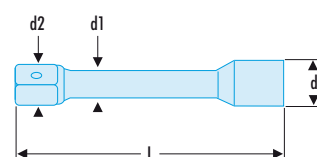

NF ISO 3316, ISO 3316, DIN 3123, ASME B107.10

- Finish: satin chrome.

☞	d [mm]	d1 [mm]	d2 [mm]	L [mm]	ΔΔ [kg]
<b>K.208B</b>	36	25	25	100	0,410
<b>K.210B</b>	36	20	25	200	0,620
<b>K.215B</b>	36	20	25	400	1,130

3/4" universal joint

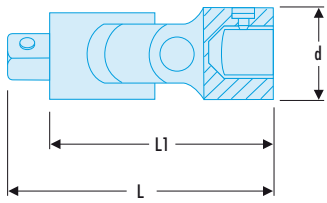

NF ISO 3316, ISO 3316, DIN 3123, ASME B107.10

- Spring-stiffened joints.
- Significant time savings.
- Finish: satin chrome.

➤	d [mm]	L [mm]	L1 [mm]	ΔΔ [g]
<b>K.240A</b>	40	105	82	550

3/4" to 1/2" coupler

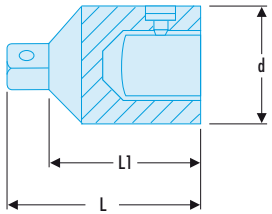

NF ISO 3316, ISO 3316, DIN 3123, ASME B107.10

- For adapting sockets and accessories 1/2".
- Interchangeable 1/2" male square ref. K.230B1.
- Max. torque 512 N.m.
- Finish: satin chrome, phosphate square.

➤	d [mm]	L [mm]	L1 [mm]	ΔΔ [g]
<b>K.230B</b>	36	58,5	43	250

**K.230B1** Interchangeable 1/2" male drive



- Interchangeable 1/2" male drive for 3/4" to 1/2" coupler reference K.230B.
- Finish: satin chrome.

3/4" to 1" coupler

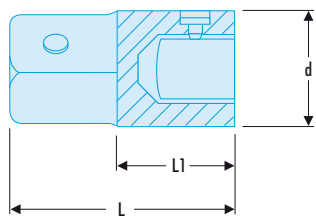

NF ISO 3316, ISO 3316, DIN 3123, ASME B107.10

- For adapting sockets and accessories 1".
- Finish: satin chrome.

➤	d [mm]	L [mm]	L1 [mm]	ΔΔ [g]
<b>K.232A</b>	36	67	39	340

LOCKING SOCKETS AND ACCESSORIES 3/4" - 1"

SAFETY AND COMFORT !

- Lock system prevents accidental socket loss during use.
- Quick release simply by pressing the plunger.
- Compatible with the standard ball-lock tools.

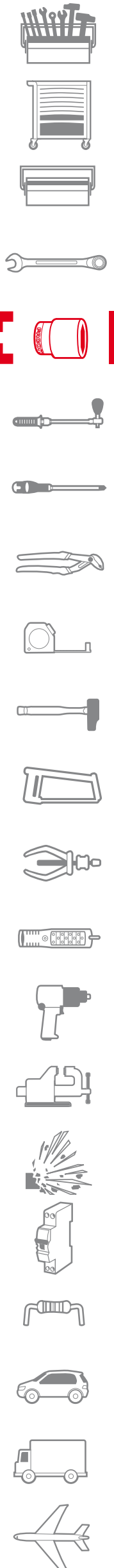
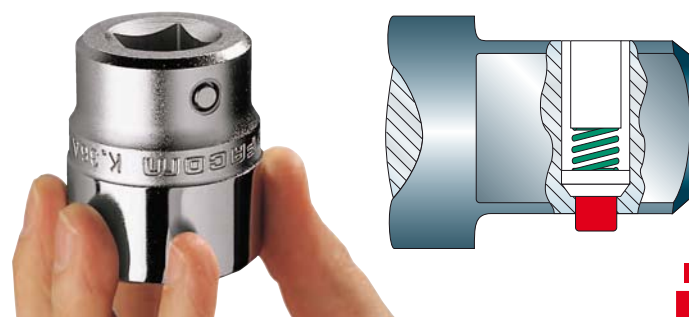



# "Truck" 3/4" range

## Sockets 3/4"

### ▣ K.HB 3/4" drive metric 6-point sockets

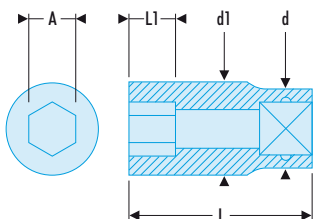

NF ISO 2725-1, NF ISO 1711-1, ISO 2725-1, ISO 1711-1, DIN 3124, ASME B107.5

- OGV® profile: more powerful tightening, preserves fasteners.
- Secure attachment of plunger lock accessories
- Quick release button.
- Finish: satin chrome.

⇒	A [mm]	⊙ [mm]	d [mm]	d1 [mm]	L [mm]	L1 [mm]	ΔΔ [g]
<b>K.19HB</b>	19	6	36	30,1	51,0	14	207
<b>K.21HB</b>	21	6	36	32,0	51,0	14	208
<b>K.22HB</b>	22	6	36	33,4	51,0	14	221
<b>K.23HB</b>	23	6	36	36,0	52,5	14	244
<b>K.24HB</b>	24	6	36	36,0	52,5	16	237
<b>K.26HB</b>	26	6	36	38,9	52,5	16	231
<b>K.27HB</b>	27	6	36	39,7	52,5	18	232
<b>K.28HB</b>	28	6	36	41,0	52,5	18	239
<b>K.29HB</b>	29	6	36	42,0	52,5	18	245
<b>K.30HB</b>	30	6	36	43,2	59,0	20	282
<b>K.32HB</b>	32	6	36	45,9	59,0	22	301
<b>K.33HB</b>	33	6	36	48,1	59,0	22	330
<b>K.34HB</b>	34	6	36	48,4	59,0	24	322

⇒	A [mm]	⊙ [mm]	d [mm]	d1 [mm]	L [mm]	L1 [mm]	ΔΔ [g]
<b>K.35HB</b>	35	6	36	50,1	59,0	24	344
<b>K.36HB</b>	36	6	36	51,0	59,0	24	347
<b>K.38HB</b>	38	6	40	54,3	66,9	27	478
<b>K.40HB</b>	40	6	40	56,0	66,9	27	493
<b>K.41HB</b>	41	6	40	57,3	66,9	27	504
<b>K.42HB</b>	42	6	40	59,5	66,9	27	552
<b>K.43HB</b>	43	6	40	60,7	66,9	27	560
<b>K.44HB</b>	44	6	40	61,9	66,9	28	587
<b>K.46HB</b>	46	6	40	63,5	75,0	30	641
<b>K.50HB</b>	50	6	40	68,5	75,0	33	725
<b>K.54HB</b>	54	6	45	74,0	75,0	36	880
<b>K.55HB</b>	55	6	45	74,7	75,0	36	875

### ▣ K.B 3/4" drive metric 12-point sockets

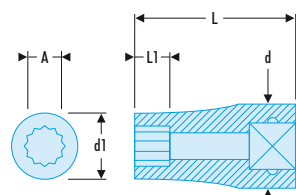

NF ISO 2725-1, NF ISO 1711-1, ISO 2725-1, ISO 1711-1, DIN 3124, ASME B107.5

- OGV® profile: more powerful tightening, preserves fasteners.
- Secure attachment of plunger lock accessories
- Quick release button.
- Finish: satin chrome.

⇒	A [mm]	⊙ [mm]	d [mm]	d1 [mm]	L [mm]	L1 [mm]	ΔΔ [g]
<b>K.19B</b>	19	12	36	30,1	51,0	14	207
<b>K.21B</b>	21	12	36	32,0	51,0	14	208
<b>K.22B</b>	22	12	36	33,4	51,0	14	221
<b>K.23B</b>	23	12	36	36,0	52,5	14	244
<b>K.24B</b>	24	12	36	36,0	52,5	16	237
<b>K.26B</b>	26	12	36	38,9	52,5	16	231
<b>K.27B</b>	27	12	36	39,7	52,5	18	232
<b>K.28B</b>	28	12	36	41,0	52,5	18	239
<b>K.29B</b>	29	12	36	42,0	52,5	18	245
<b>K.30B</b>	30	12	36	43,2	59,0	20	282
<b>K.32B</b>	32	12	36	45,9	59,0	22	301
<b>K.33B</b>	33	12	36	48,1	59,0	22	330
<b>K.34B</b>	34	12	36	48,4	59,0	24	322
<b>K.35B</b>	35	12	36	50,1	59,0	24	344

⇒	A [mm]	⊙ [mm]	d [mm]	d1 [mm]	L [mm]	L1 [mm]	ΔΔ [g]
<b>K.36B</b>	36	12	36	51,0	59,0	24	347
<b>K.38B</b>	38	12	40	54,3	66,9	27	478
<b>K.40B</b>	40	12	40	56,0	66,9	27	493
<b>K.41B</b>	41	12	40	57,3	66,9	27	504
<b>K.42B</b>	42	12	40	59,5	66,9	27	552
<b>K.43B</b>	43	21	40	60,7	66,9	28	301
<b>K.44B</b>	44	12	40	61,9	66,9	28	587
<b>K.46B</b>	46	12	40	63,5	75,0	30	641
<b>K.50B</b>	50	12	40	68,5	75,0	33	725
<b>K.54B</b>	54	12	45	74,0	75,0	36	880
<b>K.55B</b>	55	12	45	74,7	75,0	36	875

### ▣ K.B 3/4" drive inch 12-point sockets

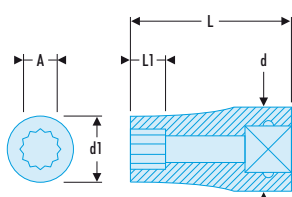

#### ASME B107.1

- OGV® profile: more powerful tightening, preserves fasteners.
- Secure attachment of plunger lock accessories
- Quick release button.
- Finish: satin chrome.

➤	A ["]	⊘ [mm]	d [mm]	d1 [mm]	L [mm]	L1 [mm]	ΔΔ [g]
<b>K.3/4B</b>	3/4	12	36	30,1	51,0	14	207
<b>K.7/8B</b>	3/4	12	36	33,6	51,0	14	220
<b>K.15/16B</b>	15/16	12	36	35,7	52,5	14	233
<b>K.1"B</b>	1"	12	36	38,0	52,5	14	250
<b>K.1'1/16B</b>	1 1/16"	12	36	39,7	52,5	18	232
<b>K.1'1/8B</b>	1 1/8"	12	36	41,6	52,5	18	241
<b>K.1'3/16B</b>	1 3/16"	12	36	43,2	59,0	20	280
<b>K.1'1/4B</b>	1 1/4"	12	36	45,9	59,0	22	304
<b>K.1'5/16B</b>	1 5/16"	12	36	48,1	59,0	22	326
<b>K.1'3/8B</b>	1 3/8"	12	36	50,1	59,0	24	343
<b>K.1'7/16B</b>	1 7/16"	12	36	51,0	59,0	24	339
<b>K.1'1/2B</b>	1 1/2"	12	40	54,3	66,9	27	478

➤	A ["]	⊘ [mm]	d [mm]	d1 [mm]	L [mm]	L1 [mm]	ΔΔ [g]
<b>K.1'9/16B</b>	1 9/16"	12	40	56,0	66,9	27	498
<b>K.1'5/8B</b>	1 5/8"	12	40	57,3	66,9	27	498
<b>K.1'11/16B</b>	1 11/16"	12	40	60,7	66,9	27	564
<b>K.1'3/4B</b>	1 3/4"	12	40	62,2	66,9	28	586
<b>K.1'13/16B</b>	1 13/16"	12	40	63,5	75,0	30	641
<b>K.1'7/8B</b>	1 7/8"	12	40	66,2	75,0	33	699
<b>K.2"B</b>	2"	12	40	68,5	75,0	33	698
<b>K.2'1/8B</b>	2 1/8"	12	45	74,0	75,0	36	880
<b>K.2'3/16B</b>	2 3/16"	12	45	74,7	75,0	36	855
<b>K.2'1/4B</b>	2 1/4"	12	45	77,1	75,0	36	913

### ▣ K.LA 3/4" long-reach metric 6-point sockets

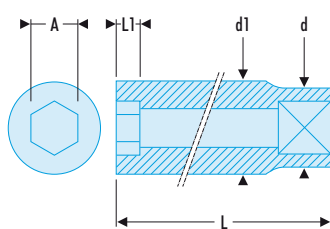

#### NF ISO 2725-1, NF ISO 1711-1, ISO 2725-1, ISO 1711-1, DIN 3124, ASME B107.5

- OGV® profile: more powerful tightening, preserves fasteners.
- Secure attachment of plunger lock accessories
- Quick release button.
- Finish: satin chrome.

➤	A [mm]	⊘ [mm]	d [mm]	d1 [mm]	L [mm]	L1 [mm]	ΔΔ [g]
<b>K.19LA</b>	19	6	36	30,1	90	18	339
<b>K.21LA</b>	21	6	36	32,0	90	18	367
<b>K.22LA</b>	22	6	36	33,4	90	21	391
<b>K.23LA</b>	23	6	38	36,0	90	21	461
<b>K.24LA</b>	24	6	38	36,0	90	24	400
<b>K.26LA</b>	26	6	36	38,9	90	24	474
<b>K.27LA</b>	27	6	38	39,7	90	27	480
<b>K.29LA</b>	29	6	40	42,0	90	27	505
<b>K.30LA</b>	30	6	40	43,2	90	30	530

➤	A [mm]	⊘ [mm]	d [mm]	d1 [mm]	L [mm]	L1 [mm]	ΔΔ [g]
<b>K.32LA</b>	32	6	40	45,9	90	33	540
<b>K.33LA</b>	33	6	45	48,1	90	33	600
<b>K.34LA</b>	34	6	45	48,4	90	33	656
<b>K.35LA</b>	35	6	45	50,1	90	33	707
<b>K.36LA</b>	36	6	45	51,0	90	36	672
<b>K.38LA</b>	38	6	45	54,3	90	36	772
<b>K.41LA</b>	41	6	45	57,3	90	40	778
<b>K.42LA</b>	42	6	45	59,5	90	40	863

### ▣ KT.A 3/4" drive metric bits for hexagon socket heads

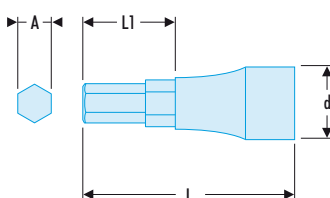

- Interchangeable bits with plunger lock.
- Finish: chrome with phosphate bit.

➤	A [mm]	d [mm]	Bits	L [mm]	L1 [mm]	ΔΔ [g]
<b>KT.14A</b>	14	36	ET.1914	74,5	25	297
<b>KT.17A</b>	17	36	ET.1917	74,5	25	307
<b>KT.19A</b>	19	36	ET.1919	74,5	25	314
<b>KT.22A</b>	22	36	ET.1919	74,5	25	314

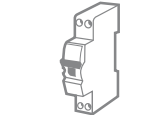
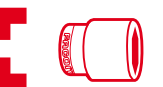
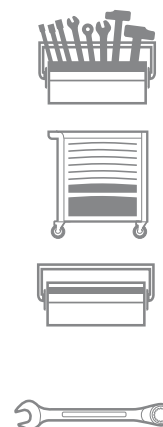

# "Mammoth" 1" range

## 1" metric socket sets

### ▣ M.431E Set of 1" drive 6-point sockets 42 to 82 mm



- Including:
    - Ratchet: M.151.
    - Sockets: M.50HA - M.54HA - M.55HA - M.58HA - M.60HA - M.63HA - M.65HA - M.67HA - M.70HA - M.71HA - M.75HA - M.77HA - M.80HA - M.82HA - M46HA.
    - Accessories: M.120A - M.210A - M.215A.
    - Metal case BT.101, dim. (L. x D. x H.): 768 x 344 x 158 mm.
    - Tray PL.57.
- Weight: 46 kg.

### ▣ M.441E Set of 1" drive 6-point sockets 58 to 100 mm



- Including:
    - Ratchet: M.151.
    - Sockets: M.58HA - M.60HA - M.63HA - M.65HA - M.67HA - M.70HA - M.71HA - M.75HA - M.77HA - M.80HA - M.82HA - M.85HA - M.90HA - M.95HA - M.100HA.
    - Accessories: M.120A - M.210A - M.215A.
    - Metal case BT.101, dim. (L. x D. x H.): 768 x 344 x 158 mm.
    - Tray PL.54.
- Weight: 64.20 kg.

### ▣ M.423E Set of 1" drive 6-point sockets 41 to 80 mm



- Including:
    - Ratchet: M.151.
    - Sockets: M.58HA - M.60HA - M.63HA - M.65HA - M.67HA - M.70HA - M.71HA - M.75HA - M.77HA - M.80HA - M.82HA - M.85HA - M.90HA - M.95HA - M.100HA.
    - Accessories: M.120A - M.210A - M.215A.
    - Metal case BT.104, dim. (L. x D. x H.): 568 x 344 x 123 mm.
    - Tray PL.85.
- Weight: 29.70 kg.

## 1" inch socket sets

### ▣ M.431U Set of 1" drive sockets 17/8" to 33/8"



- Including:
    - Ratchet: M.151.
    - Sockets: M.1'7/8HA - M.2'1/2HA - M.2'1/4HA - M.2'3/16HA - M.2'3/4HA - M.2'3/8HA - M.2'5/8HA - M.2'HA - M.3'1/8HA - M.3'3/8HA - M.3'HA - M.2'1/8HA.
    - Accessories: M.120A - M.210A - M.215A.
    - Metal case BT.101, dim. (L. x D. x H.): 768 x 344 x 158 mm.
    - Tray PL.58.
- Weight: 29.70 kg.

### Ratchets and accessories 1"

#### 1" drive ratchet without handle

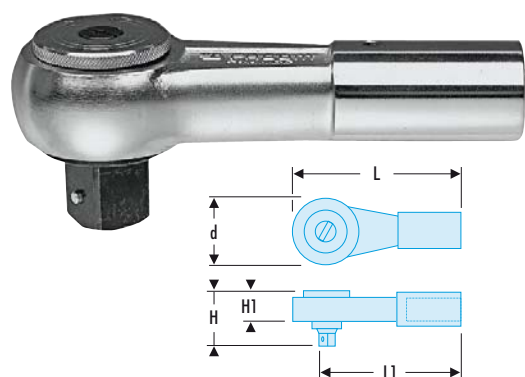

NF ISO 3315, ISO 3315, DIN 3122, ASME B107.10

- 5° increment.
- 72-tooth mechanism.
- For use with bars M.125 or M.126 and handle M.120.
- Finish: satin chrome.

➤	d [mm]	H [mm]	H1 [mm]	L [mm]	L1 [mm]	ΔΔ [kg]
<b>M.151</b>	73	77	45	197	161	2,10

#### M.A - Bars for 1" ratchet M.151

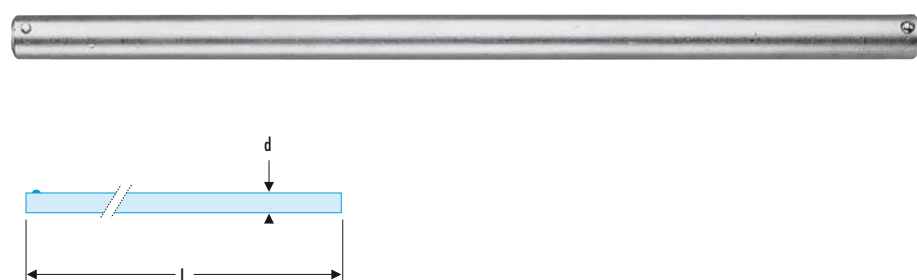

- Used as extension handles on ratchet M.151.
- Finish: satin chrome.

➤	d [mm]	L [mm]	ΔΔ [kg]
<b>M.125A</b>	25	500	1,90
<b>M.126A</b>	25	700	2,70

#### 1" drive sliding tee

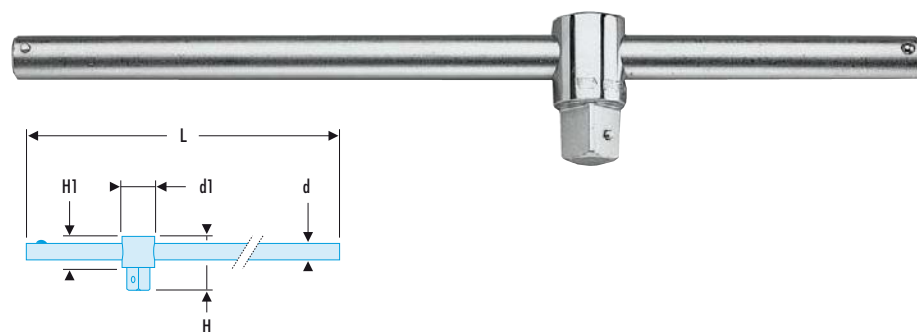

NF ISO 3315, ISO 3315, DIN 3122, ASME B107.10

- Friction-head allows bar to form a T or L-handle.
- Fitted with a lock by plunger.
- Finish: satin chrome.

➤	d [mm]	d1 [mm]	H [mm]	H1 [mm]	L [mm]	ΔΔ [kg]
<b>M.120A</b>	25	42	79	49,5	500	2,40

#### M.A - 1" drive extensions

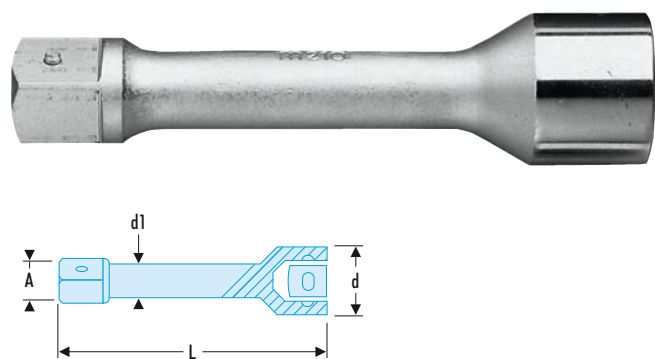

NF ISO 3315, ISO 3315, DIN 3122, ASME B107.10

- Safety plunger lock.
- Finish: satin chrome.

➤	A [mm]	d [mm]	d1 [mm]	L [mm]	ΔΔ [kg]
<b>M.210A</b>	33	48	25	200	1,10
<b>M.215A</b>	33	48	25	415	2,00

#### M.230C 1" to 3/4" coupler

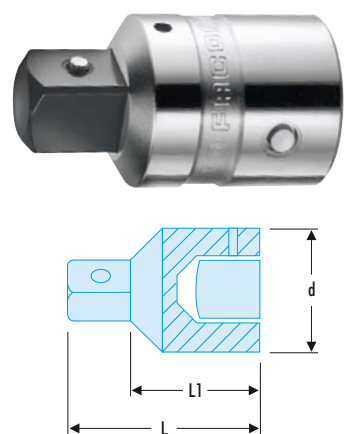

NF ISO 3316, ISO 3316, DIN 3123

- For adapting 3/4" drive sockets.
  - Interchangeable 3/4" male square ref. M.230C1.
  - Finish: satin chrome, with burnished square.
- Weight: 415 g.

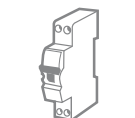

# "Mammoth" 1" range

## ▣ M.230C1 Interchangeable 3/4" male drive



- Maximum torque 1412 N.m.
  - Interchangeable 1/3" male square attaches to 1" to 3/4" coupler reference M.230C.
  - Finish: burnished.
- Weight: 111 g.

## 1" sockets

### ▣ M.HA - 1" drive metric 6-point sockets

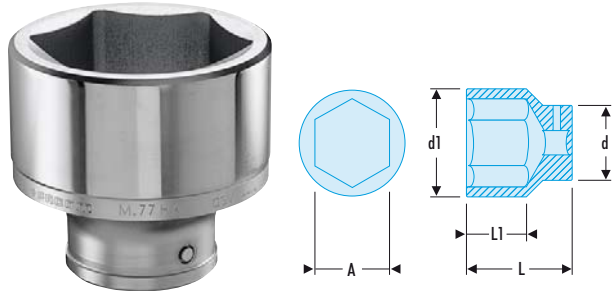

NF ISO 2725-1, NF ISO 1711-1, ISO 2725-1, ISO 1711-1, DIN 3124

- Thinner, lighter body.
- Secure attachment of plunger lock accessories.
- Push-button release.
- Finish: satin chrome.

➤	A [mm]	⊙ [mm]	d [mm]	d1 [mm]	L [mm]	L1 [mm]	ΔΔ [kg]
M.41HA	41	6	51,3	56,9	74	25	0,685
M.46HA	46	6	51,3	64,4	76	30	0,852
M.50HA	50	6	51,3	69,4	80	33	0,968
M.54HA	54	6	56,3	74,4	84	31	1,262
M.55HA	55	6	56,3	75,4	84	36	1,262
M.58HA	58	6	56,3	79,6	85	35	1,354
M.60HA	60	6	56,3	82,4	87	39	1,432
M.63HA	63	6	58,3	85,4	92	35	1,545
M.65HA	65	6	58,3	88,4	92	42	1,652
M.67HA	67	6	58,3	90,4	92	39	1,687

➤	A [mm]	⊙ [mm]	d [mm]	d1 [mm]	L [mm]	L1 [mm]	ΔΔ [kg]
M.70HA	70	6	56,3	95,0	96	45	1,921
M.71HA	71	6	56,3	96,0	96	45	1,904
M.75HA	75	6	63,3	101,0	100	48	2,261
M.77HA	77	6	63,3	108,0	100	51	2,751
M.80HA	80	6	63,3	108,0	106	52	2,800
M.82HA	82	6	63,3	110,8	110	52	2,880
M.85HA	85	6	71,3	114,0	110	52	3,225
M.90HA	90	6	71,3	121,0	110	56	3,555
M.95HA	95	6	71,3	127,0	110	56	3,800
M.100HA	100	6	71,3	133,0	115	56	4,225

### ▣ M.HA - 1" drive inch 6-point sockets

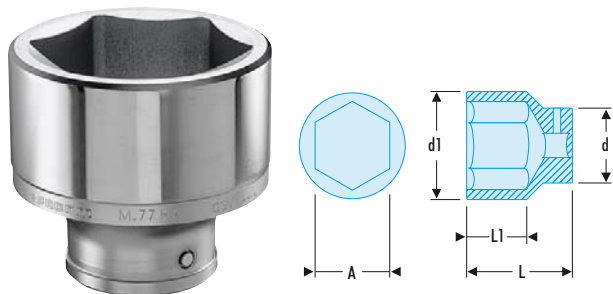

ASME B107.1

- Thinner, lighter body.
- Secure attachment of plunger lock accessories.
- Push-button release.
- Finish: satin chrome.

➤	A ["]	⊙ [mm]	d [mm]	d1 [mm]	L [mm]	L1 [mm]	ΔΔ [kg]
M.1'13/16HA	1"13/16	6	51,3	64,4	76	30	0,852
M.1'7/8HA	1"7/8	6	51,3	66,4	80	29	0,929
M.2'HA	2"	6	51,3	70,4	80	31	1,000
M.2'1/8HA	2"1/8	6	56,3	74,4	84	31	1,262
M.2'3/16HA	2"3/16	6	56,3	75,4	84	35	1,253
M.2'1/4HA	2"1/4	6	56,3	78,5	84	35	1,368
M.2'3/8HA	2"3/8	6	56,3	82,4	87	39	1,439

➤	A ["]	⊙ [mm]	d [mm]	d1 [mm]	L [mm]	L1 [mm]	ΔΔ [kg]
M.2'1/2HA	2"1/2	6	58,3	86,4	92	35	1,570
M.2'5/8HA	2"5/8	6	58,3	90,4	92	39	1,704
M.2'3/4HA	2"3/4	6	94,4	58,3	96	45	1,904
M.3'HA	3"	6	65,3	103,4	100	51	2,347
M.3'1/8HA	3"1/8	6	65,3	107,4	106	51	2,770
M.3'3/8HA	3"3/8	6	73,3	113,4	110	56	3,225

### ▣ 1" drive 12-point sockets



ASME B107.1

- Thinner, lighter body.
- Secure attachment of plunger lock accessories.
- Push-button release.
- Finish: chromed.

➤	A [mm]	⊙ [mm]	d [mm]	d1 [mm]	L [mm]	L1 [mm]	ΔΔ [kg]
M.65B	65	12	58,3	85,4	92	42	1,652

IMPACT SOCKETS AND ACCESSORIES

DEVELOPED FOR YOUR POWER TOOLS

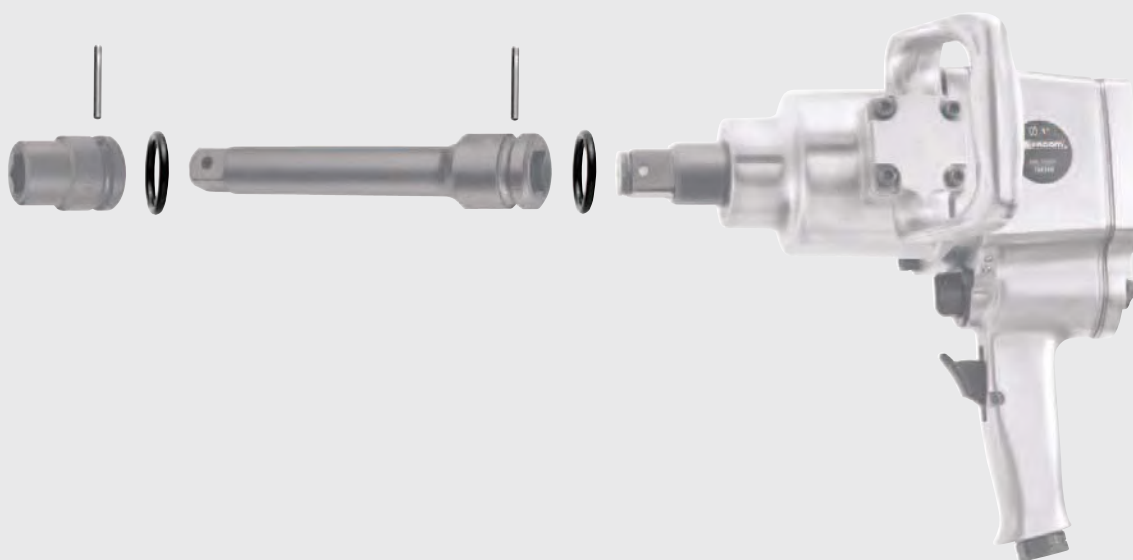

PERFORMANCE

• Specially designed to resist the stresses from impact (section 14), or "Dynapact" tools (section 5). Their special steel and heat treatment ensure a very high yield strength and wear resistance.



SAFETY

• All sockets and accessories feature a groove and side-hole to UNI ISO 2725. Locking is ensured by a through-pin and retaining ring (to be ordered separately). Never fit chrome-finished manual sockets Impact tools.





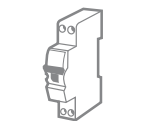



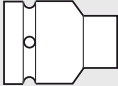

pins	Ø x L (mm)
<b>GA.15A</b>	2,5 x 15,0
<b>GA.18A</b>	2,5 x 18,0
<b>GA.20A</b>	3,0 x 20,0
<b>GA.24A</b>	3,0 x 24,0
<b>GA.37A</b>	4,0 x 37,0
<b>GA.43A</b>	5,0 x 43,0
<b>GA.75A</b>	6,0 x 75,0
<b>GA.84A</b>	6,0 x 84,0

rings	Ø bore x Ø in. (mm)
<b>BA.16A</b>	2,4 x 16,0
<b>BA.19A</b>	2,4 x 19,0
<b>BA.21A</b>	2,4 x 21,0
<b>BA.20A</b>	3,5 x 20,2
<b>BA.24A</b>	3,5 x 24,0
<b>BA.25A</b>	3,5 x 25,0
<b>BA.38A</b>	3,5 x 38,0
<b>BA.46A</b>	3,5 x 46,0
<b>BA.75A</b>	5,7 x 75,0
<b>BA.85A</b>	5,7 x 85,0

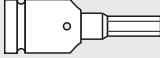

# IMPACT SOCKETS AND ACCESSORIES

## CHOOSING IMPACT TOOLS

TYPE OF TOOL	DRIVE	SIZES
Socket 	<input checked="" type="checkbox"/> 3/8" <input checked="" type="checkbox"/> 1/2" <input checked="" type="checkbox"/> 3/4" <input checked="" type="checkbox"/> 1" <input checked="" type="checkbox"/> 1 1/2"	6 > 19 mm 8 > 32 mm ; 3/8" > 1 1/16" 17 > 46 mm ; 3/4" > 1 5/8" 21 > 77 mm 55 > 120 mm 12 16 > 22 mm
TORX® 	<input checked="" type="checkbox"/> 1/2"	E10 > E24
Long-reach socket 	<input checked="" type="checkbox"/> 1/2" <input checked="" type="checkbox"/> 3/4" <input checked="" type="checkbox"/> 1"	8 > 32 mm    8 > 32 mm 17 > 46 mm    21 > 36 mm 22 > 70 mm    24 > 50 mm
Extra-long-reach socket 	<input checked="" type="checkbox"/> 1"	30, 32, 33 mm
Monobloc bit 	<input checked="" type="checkbox"/> 1/2" <input checked="" type="checkbox"/> 3/4"	5 > 19 mm 17 > 24 mm T30 > T60
Extension 	<input checked="" type="checkbox"/> 3/8" <input checked="" type="checkbox"/> 1/2" <input checked="" type="checkbox"/> 3/4" <input checked="" type="checkbox"/> 1" <input checked="" type="checkbox"/> 1 1/2"	L : 76 - 150 mm L : 50 - 252 mm L : 100 - 330 mm L : 125 - 330 mm L : 250 - 330 mm
Universal joint 	<input checked="" type="checkbox"/> 3/8" <input checked="" type="checkbox"/> 1/2"	1 model per drive
Coupler 	<input checked="" type="checkbox"/> 3/8" <input checked="" type="checkbox"/> 1/2" <input checked="" type="checkbox"/> 3/4" <input checked="" type="checkbox"/> 1" <input checked="" type="checkbox"/> 1 1/2"	<input checked="" type="checkbox"/> 3/8" > <input checked="" type="checkbox"/> 1/2" <input checked="" type="checkbox"/> 3/8" > <input checked="" type="checkbox"/> 1/4" <input checked="" type="checkbox"/> 1/2" > <input checked="" type="checkbox"/> 3/4" <input checked="" type="checkbox"/> 1/2" > <input checked="" type="checkbox"/> 3/8" <input checked="" type="checkbox"/> 3/4" > <input checked="" type="checkbox"/> 1" <input checked="" type="checkbox"/> 3/4" > <input checked="" type="checkbox"/> 1" <input checked="" type="checkbox"/> 1" > <input checked="" type="checkbox"/> 1 1/2" <input checked="" type="checkbox"/> 1" > <input checked="" type="checkbox"/> 3/4" <input checked="" type="checkbox"/> 1 1/2" > <input checked="" type="checkbox"/> 2 1/2" <input checked="" type="checkbox"/> 1 1/2" > <input checked="" type="checkbox"/> 1"
Dynapact wrench 	<input checked="" type="checkbox"/> 3/4" <input checked="" type="checkbox"/> 1"	1000 Nm 2000 Nm
Impact screwdrivers 	<input checked="" type="checkbox"/> 3/8" <input checked="" type="checkbox"/> 1/2"	200 Nm 400 Nm



Impact sockets 3/8"

IMPACT SOCKETS AND ACCESSORIES  $\square$  3/8"

SAFETY FIRST

- For your safety, use impact sockets and accessories with the appropriate rings and pins.
- Never fit chrome-finished manual sockets or accessories to impact tools.

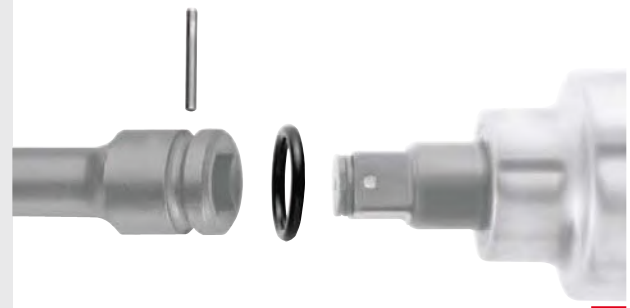

$\square$  NJ.A - 3/8" drive metric 6-point impact sockets

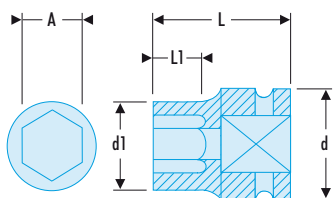

NF ISO 2725-2, NF ISO 1711-2, ISO 2725-2, ISO 1711-2, DIN 3129, ASME B107.33

- For your safety, use impact sockets and accessories with the appropriate rings and pins.

$\Rightarrow$	A	$\odot$	d	d1	GA	BA	L	L1	$\Delta\Delta$
	[mm]	[mm]	[mm]	[mm]			[mm]	[mm]	[g]
<b>NJ.6A</b>	6	6	19	11,5	GA.15A	BA.16A	30	6,0	38
<b>NJ.7A</b>	7	6	19	12,5	GA.15A	BA.16A	30	8,0	41
<b>NJ.8A</b>	8	6	19	14,0	GA.15A	BA.16A	30	8,0	41
<b>NJ.9A</b>	9	6	19	15,0	GA.15A	BA.16A	30	8,0	42
<b>NJ.10A</b>	10	6	19	16,5	GA.15A	BA.16A	30	8,0	41
<b>NJ.11A</b>	11	6	19	17,5	GA.15A	BA.16A	32	9,0	47
<b>NJ.12A</b>	12	6	19	19,0	GA.15A	BA.16A	30	9,0	49
<b>NJ.13A</b>	13	6	22	20,0	GA.18A	BA.19A	30	10,0	49
<b>NJ.14A</b>	14	6	22	21,5	GA.18A	BA.19A	30	11,5	63
<b>NJ.15A</b>	15	6	22	22,0	GA.18A	BA.19A	30	11,0	67
<b>NJ.16A</b>	16	6	22	24,0	GA.18A	BA.19A	30	12,5	72
<b>NJ.17A</b>	17	6	22	25,0	GA.18A	BA.19A	30	12,5	70
<b>NJ.18A</b>	18	6	22	26,5	GA.18A	BA.19A	30	12,5	73
<b>NJ.19A</b>	19	6	22	27,5	GA.18A	BA.19A	30	14,0	77

CREATE YOUR OWN BIT SOCKETS

Screw bits



- Series 2  $\odot$  5/16"
- Series 3  $\odot$  1/2"

$\Rightarrow$  See Section 7

Impact bit holder  $\square$  3/8"



**NJ.236A**  
 $\odot$  5/16"  
7.94 mm



**NJ.237A**  
 $\odot$  1/2"  
12.70 mm

$\Rightarrow$  See p. 322



$\square$  NJ.A - 3/8" drive impact extensions

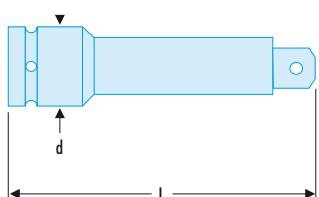

ASME B107.2

- For your safety, use impact extensions and accessories with the appropriate rings and pins.

$\Rightarrow$	d [mm]	GA	BA	L [mm]	$\Delta\Delta$ [g]
<b>NJ.210A</b>	19	GA.15A	BA.16A	75	95
<b>NJ.211A</b>	19	GA.15A	BA.16A	150	170

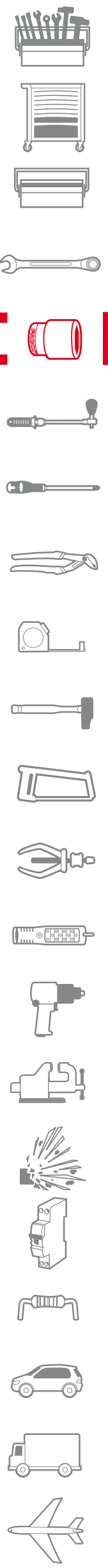



# "Impact" range

## 3/8" drive impact universal joint



### ASME B107.2

- For your safety, use impact universal joints with the appropriate rings and pins.

Part No.	d [mm]	GA	BA	L [mm]	$\Delta\Delta$ [g]
<b>NJ.240A</b>	23.85	GA.18A	BA.20A	51	85

## NJ.A - 3/8" drive impact couplers

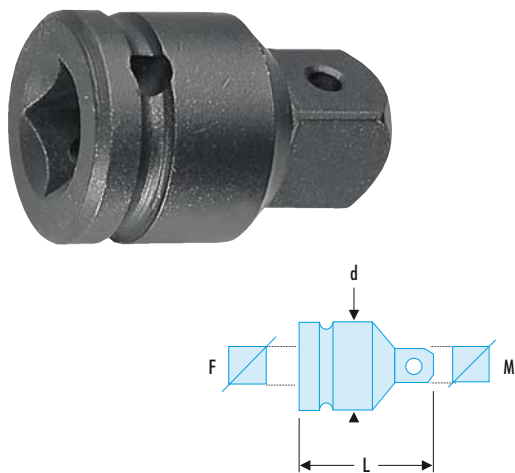

### ASME B107.2

- For your safety, use impact couplers with the appropriate rings and pins.
- NJ.230A: 1/4" socket coupler.
- NJ.232A: 1/2" socket coupler.

Part No.	Square ["]	d [mm]	GA	BA	L [mm]	$\Delta\Delta$ [g]
<b>NJ.230A</b>	F = 3/8" - M = 1/4"	22	GA.18A	BA.19A	32	40
<b>NJ.232A</b>	F = 3/8" - M = 1/2"	22	GA.18A	BA.19A	36	95

## FACOM POWER TOOLS

### FACOM HAS A WIDE RANGE OF AIR AND PORTABLE ELECTRIC TOOLS,

Including impact wrenches, ratchets, screwdrivers, drills, grinders, sanders, power chisels, etc.

➔ See section 14 p.676



## Impact accessories 3/8"

### NJ.A - 3/8" bit holder impact sockets

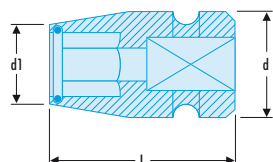

### NF ISO 1711-2, ISO 1711-2, DIN 3121,

- NJ.236A: for 5/16 bits.
- NJ.237A: for 1/2 bits.

Part No.	A ["]	Vierkant ["]	d [mm]	d1 [mm]	GA	BA	L [mm]	$\Delta\Delta$ [g]
<b>NJ.236A</b>	5/16	3/8	19	14,0	GA.15A	BA.16A	37	35
<b>NJ.237A</b>	1/2	3/8	19	19	GA.15A	BA.16A	37	40

Impact sockets 3/8" and bits

**JHX.14** Case with 14 impact 3/8" bits



- Including:
  - 2 bit holder sockets: 3/8", diam. 1/2" and 5/16" (Ref NJ.236A and NJ.237A).
  - 6 hex impact bits: 6 - 7 - 8 - 10 - 12 - 14 mm (Ref ENH.306 - ENH.307 - ENH.308 - ENH.310 - ENH.312 - ENH.314).
  - 5 Torx® impact bits: T30 - T40 - T45 - T50 - T55 (Ref NEX.30A - NEX.40A - NEX.45A - NEX.50A - NEX.55A).
  - 3 Phillips impact bits: PH2 - PH3 - PH4 (Réf ENP.202 - ENP.203 - ENP.204).
  - Plastic case BP.102, dim. (L. x D. x H.): 204 x 122 x 52 mm.
  - Thermoformed module PL402A.
- Weight: 780 g.

Impact sockets 1/2" and accessories set

**NS.550A** Set of 1/2" short and long-reach impact sockets 10 to 32 mm



- Suitable for all automotive works: short sockets, long sockets, aluminium wheel sockets (17 - 19 - 21 mm).
  - For your safety, use impact sockets and accessories with the appropriate rings and pins (supplied in the case).
  - Comprising:
  - Standard sockets: 10 - 11 - 12 - 13 - 14 - 15 - 16 - 17 - 18 - 19 - 21 - 22 - 24 - 27 - 30 - 32 mm.
  - Long-reach sockets: 10 - 13 - 16 - 18 mm.
  - Sockets for alloy wheel nuts: 17 - 19 - 21 mm.
  - Extension: NS.215A.
  - Rings and associated pins.
  - Plastic case BP.109, dim. (L. x D. x H.): 478 x 234 x 72 mm.
  - Tray PL.716.
- Weight: 5.10 kg.

**NS.500A** Set of 1/2" impact sockets 8 to 27 mm



- For your safety, use impact sockets and accessories with the appropriate rings and pins.
  - Comprising:
  - Sockets: 8 - 9 - 10 - 11 - 12 - 13 - 14 - 15 - 16 - 17 - 18 - 19 - 21 - 22 - 24 - 27 mm.
  - Universal joint: NS.240A.
  - Extension: NS.215A.
  - Rings and associated pins.
  - Plastic case BP.112, dim. (L. x D. x H.): 389 x 164 x 66 mm.
  - Tray PL.416.
- Weight: 3.70 kg.

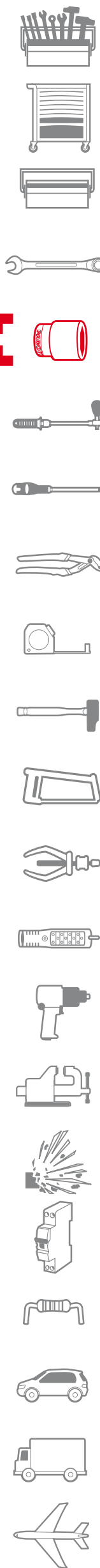

### ▣ **NS.500AU** Set of 1/2" impact sockets from 3/8" to 1"1/16



- For your safety, use impact sockets and accessories with the appropriate rings and pins.
  - Comprising:
    - NS.A sockets: 3/8" --> 1"1/16.
    - Universal joint: NS.240A.
    - Extension: NS.215A.
    - Rings and associated pins.
    - Plastic case BP.112, dim. (L. x D. x H.): 389 x 164 x 66 mm.
    - Tray PL.417.
- Weight: 3.10 kg.

### ▣ **NS.405A** Set of 1/2" long-reach impact sockets 10 to 24 mm



- For your safety, use impact sockets and accessories with the appropriate rings and pins.
  - Comprising:
    - 1/2" long-reach sockets: 10 - 11 - 12 - 13 - 14 - 16 - 17 - 19 - 21 - 22 - 23 - 24 mm.
    - Plastic case BP.112, dim. (L. x D. x H.): 389 x 164 x 66 mm.
    - Tray PL.418.
- Weight: 4 kg.

### ▣ **NS.J9** 9-piece rack set of 1/2" drive metric 6-point impact sockets



- A selection of the most popular sizes for automotive applications: NS.13A - NS.14A - NS.16A - NS.17A - NS.18 - NS.19A - NS.21A - NS.22A - NS.24A.
  - Essential accessory for any 1/2" drive.
  - Supplied on rack CKS.95.
- Weight: 1.20 kg.

### ▣ **NSB.3** 3-piece set of 1/2" long-reach thin-wall impact sockets for wheel nuts



- Includes long-reach sockets NSB.17 - NSB.19 - NSB.21.
  - Special series for wheel nuts.
- Weight: 740 g.

### ■ NSTX.J7 7-piece Torx® 1/2" impact socket rack set



- For your safety, use impact sockets and accessories with the appropriate rings and pins.
  - Set of 7 Torx® impact sockets drive 1/2".
  - Comprising:
    - NSTX: E10 - E12 - E14 - E16 - E18 - E20 - E24.
  - Supplied on rack CKS.97.
- Weight: 770 g.

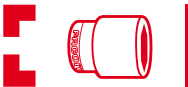

### ■ NSHM.J8 8-piece rack set of 1/2" drive metric bits for hexagon socket heads



- For your safety, use impact sockets and accessories with the appropriate rings and pins.
  - Set of 8 bits 1/2" drive for hexagon socket heads.
  - Includes sizes: NSHM.5 - 6 - 8 - 10 - 12 - 14 - 17 - 19.
  - Supplied on a rack CKS.95.
- Weight: 1.20 kg.



### ■ NHX.14A 14-piece 1/2" drive impact bit set



- Comprising:
    - 2 bit holders 1/2" square drive, diam. 1/2" and 5/16".
    - 6 hex: 6 - 7 - 8 - 10 - 12 and 14 mm.
    - Torx®: 30 - 40 - 45 - 50 - 55.
    - Phillips®: 2 - 3 - 4.
    - Plastic case BP.102.
    - Tray PL.402A.
- Weight: 800 g.

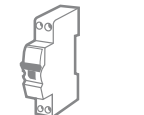
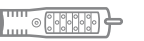

### ■ MOD.NS1 1/2" drive impact socket module NS1



- Comprising:
    - 1/2" drive impact sockets: NSA 10 - 11 - 12 - 13 - 14 - 15 - 16 - 17 - 18 - 19 - 21 - 22 - 23 - 24 mm.
    - 1/2" extension: NS215A 125 mm.
    - Tray PL610.
- Weight: 2 kg.



# "Impact" range

## MOD.NS2 1/2" drive metric 6-point impact socket module



- Comprising:
  - Impact short sockets 1/2": NS.A 13 - 14 - 15 - 16 - 17 - 18 - 19 - 21 - 22 - 24 - 27 - 30 - 32 mm
  - Impact sockets 1/2" bit holders: NS.236A and NS.237A
  - Impact bits: ENH.3 6 - 7 - 8 - 10 - 12 - 14; ENP.2 2 - 3 - 4; NEX.A 30 - 40 - 45 - 50 - 55.
  - Tray PL.623.
- Weight: 985 g.

## Impact sockets 1/2" and accessories

### NS.A - 1/2" drive metric 6-point impact sockets

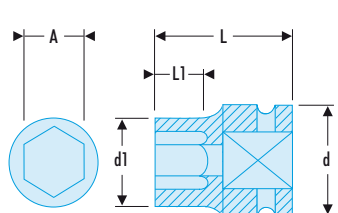

NF ISO 2725-2, NF ISO 1711-2, ISO 2725-2, ISO 1711-2, DIN 3129, ASME B107.33

- For your safety, use impact sockets and accessories with the appropriate rings and pins.

➤	A [mm]	⊕ [mm]	d [mm]	d1 [mm]	GA	BA	L [mm]	L1 [mm]	ΔΔ [g]
<b>NS.8A</b>	8	6	25	15,0	GA.20A	BA.20A	38	9	70
<b>NS.9A</b>	9	6	25	16,0	GA.20A	BA.20A	38	12	70
<b>NS.10A</b>	10	6	25	17,5	GA.20A	BA.20A	38	12	75
<b>NS.11A</b>	11	6	25	18,7	GA.20A	BA.20A	38	12	76
<b>NS.12A</b>	12	6	25	20,0	GA.20A	BA.20A	38	12	75
<b>NS.13A</b>	13	6	25	21,0	GA.20A	BA.20A	38	12	76
<b>NS.14A</b>	14	6	25	22,5	GA.20A	BA.20A	38	12	83
<b>NS.15A</b>	15	6	30	23,7	GA.24A	BA.25A	38	12	112
<b>NS.16A</b>	16	6	30	25,0	GA.24A	BA.25A	38	12	105
<b>NS.17A</b>	17	6	30	26,5	GA.24A	BA.25A	38	13	112
<b>NS.18A</b>	18	6	30	27,5	GA.24A	BA.25A	38	13	110
<b>NS.19A</b>	19	6	30	29,0	GA.24A	BA.25A	38	14	112
<b>NS.20A</b>	20	6	30	30,0	GA.24A	BA.25A	38	15	116
<b>NS.21A</b>	21	6	30	31,0	GA.24A	BA.25A	38	15	156
<b>NS.22A</b>	22	6	30	32,5	GA.24A	BA.25A	38	16	156
<b>NS.23A</b>	23	6	30	33,5	GA.24A	BA.25A	38	16	156
<b>NS.24A</b>	24	6	30	35,0	GA.24A	BA.25A	45	20	169
<b>NS.26A</b>	26	6	30	38,0	GA.24A	BA.25A	50	24	192
<b>NS.27A</b>	27	6	30	39,0	GA.24A	BA.25A	50	24	220
<b>NS.28A</b>	28	6	30	40,0	GA.24A	BA.25A	50	24	273
<b>NS.29A</b>	29	6	30	41,0	GA.24A	BA.25A	50	24	276
<b>NS.30A</b>	30	6	30	43,0	GA.24A	BA.25A	50	24	285
<b>NS.32A</b>	32	6	30	45,0	GA.24A	BA.25A	50	24	278

### NS.A - 1/2" drive inch 6-point impact sockets

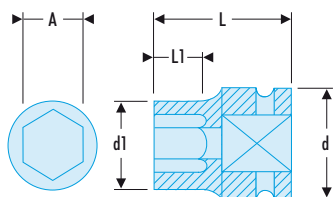

ASME B107.2

- For your safety, use impact sockets and accessories with the appropriate rings and pins.

➤	A ["]	⊕ [mm]	d [mm]	d1 [mm]	GA	BA	L [mm]	L1 [mm]	ΔΔ [g]
<b>NS.3/8A</b>	3/8	6	25	17,5	GA.20A	BA.20A	38	12	75
<b>NS.7/16A</b>	7/16	6	25	18,7	GA.20A	BA.20A	38	12	76
<b>NS.1/2A</b>	1/2	6	25	21,0	GA.20A	BA.20A	38	12	76
<b>NS.9/16A</b>	9/16	6	25	22,5	GA.20A	BA.20A	38	12	83
<b>NS.5/8A</b>	5/8	6	30	25,0	GA.24A	BA.25A	38	12	105
<b>NS.11/16A</b>	11/16	6	30	26,5	GA.24A	BA.25A	38	13	112
<b>NS.3/4A</b>	3/4	6	30	29,0	GA.24A	BA.25A	38	14	112
<b>NS.13/16A</b>	13/16	6	30	31,0	GA.24A	BA.25A	38	15	156
<b>NS.7/8A</b>	7/8	6	30	33,5	GA.24A	BA.25A	38	16	162
<b>NS.15/16A</b>	15/16	6	30	33,5	GA.24A	BA.25A	38	16	162
<b>NS.1'A</b>	1'	6	30	38,0	GA.24A	BA.25A	50	24	192
<b>NS.1'1/16A</b>	1' 1/16	6	30	39,0	GA.24A	BA.25A	50	24	220

### ■ NS.LA - 1/2" drive long-reach metric 6-point impact sockets

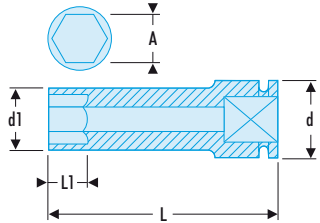

NF ISO 2725-2, NF ISO 1711-2, ISO 2725-2, ISO 1711-2, DIN 3129, ASME B107.33

• For your safety, use impact sockets and accessories with the appropriate rings and pins.

➤	A [mm]	⌀ [mm]	d [mm]	d1 [mm]	GA	BA	L [mm]	L1 [mm]	ΔΔ [g]
<b>NS.8LA</b>	8	6	25	15,0	GA.20A	BA.20A	78	13	130
<b>NS.10LA</b>	10	6	25	17,5	GA.20A	BA.20A	78	14	154
<b>NS.11LA</b>	11	6	25	18,7	GA.20A	BA.20A	78	14	163
<b>NS.12LA</b>	12	6	25	20,0	GA.20A	BA.20A	78	14	169
<b>NS.13LA</b>	13	6	25	21,0	GA.20A	BA.20A	78	14	185
<b>NS.14LA</b>	14	6	25	22,5	GA.20A	BA.20A	78	17	201
<b>NS.16LA</b>	16	6	30	25,0	GA.24A	BA.25A	78	17	224
<b>NS.17LA</b>	17	6	30	26,0	GA.24A	BA.25A	78	17	252
<b>NS.18LA</b>	18	6	30	27,5	GA.24A	BA.25A	78	17	283
<b>NS.19LA</b>	19	6	30	29,0	GA.24A	BA.25A	78	19	268
<b>NS.21LA</b>	21	6	30	31,0	GA.24A	BA.25A	78	24	310
<b>NS.22LA</b>	22	6	30	32,5	GA.24A	BA.25A	78	24	302
<b>NS.23LA</b>	23	6	30	33,5	GA.24A	BA.25A	78	24	298
<b>NS.24LA</b>	24	6	30	35,0	GA.24A	BA.25A	78	24	309
<b>NS.26LA</b>	26	6	30	38,0	GA.24A	BA.25A	78	24	311
<b>NS.27LA</b>	27	6	30	39,0	GA.24A	BA.25A	78	24	325
<b>NS.28LA</b>	28	6	30	40,0	GA.24A	BA.25A	78	24	323
<b>NS.29LA</b>	29	6	30	41,0	GA.24A	BA.25A	78	24	357
<b>NS.30LA</b>	30	6	30	43,0	GA.24A	BA.25A	78	24	352
<b>NS.32LA</b>	32	6	30	45,0	GA.24A	BA.25A	78	24	317

### ■ NSB - 1/2" drive long-reach metric thin-wall 6-point impact sockets

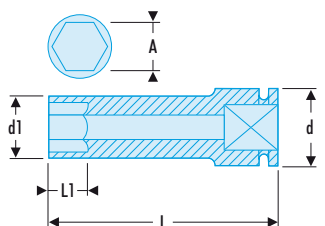

NF ISO 2725-2, NF ISO 1711-2, ISO 2725-2, ISO 1711-2, DIN 3129, ASME B107.33

• For your safety, use impact sockets and accessories with the appropriate rings and pins.  
• Thin wall for better access.  
• 6-point convex pattern for increased resilience.

➤	A [mm]	⌀ [mm]	d1 [mm]	GA	BA	L [mm]	L1 [mm]	ΔΔ [g]
<b>NSB.8</b>	8	6	13,0	GA.20A	BA.20A	80	8	165
<b>NSB.10</b>	10	6	15,0	GA.20A	BA.20A	80	10	170
<b>NSB.13</b>	13	6	19,0	GA.20A	BA.20A	80	13	210
<b>NSB.15</b>	15	6	22,0	GA.24A	BA.25A	80	15	220
<b>NSB.16</b>	16	6	23,0	GA.24A	BA.25A	80	16	230
<b>NSB.17</b>	17	6	24,0	GA.24A	BA.25A	80	17	245
<b>NSB.18</b>	18	6	25,5	GA.24A	BA.25A	80	18	245
<b>NSB.19</b>	19	6	27,0	GA.24A	BA.25A	80	19	240
<b>NSB.21</b>	21	6	30,0	GA.24A	BA.25A	80	22	245
<b>NSB.22</b>	22	6	31,0	GA.24A	BA.25A	85	23	250
<b>NSB.24</b>	24	6	32,0	GA.24A	BA.25A	85	24	280
<b>NSB.27</b>	27	6	36,0	GA.24A	BA.25A	85	27	325
<b>NSB.30</b>	30	6	39,0	GA.24A	BA.25A	85	30	330
<b>NSB.32</b>	32	6	41,0	GA.24A	BA.25A	85	32	335

### SOCKETS FOR ALLOY WHEELS

• NSAL.3 = set of 3 deep impact sockets with protective plastic sleeves to prevent damage to polished chrome or alloy wheels.

➤ See Section 19 p. 954

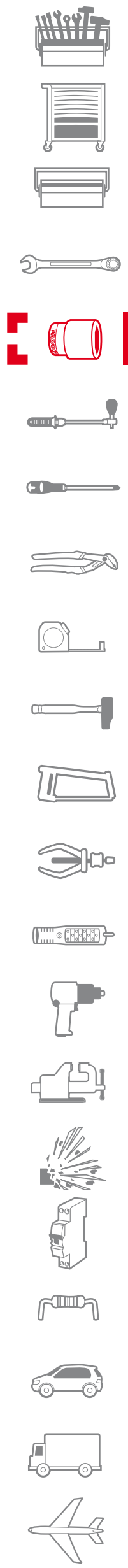

## ■ NSTX Torx® 1/2" impact sockets

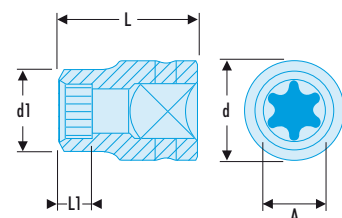

- For your safety, use impact sockets and accessories with the appropriate rings and pins.
- For Torx® male drive fasteners.

➤	A [mm]	Torx [No]	d [mm]	d1 [mm]	GA	BA	L [mm]	ΔΔ [g]
<b>NSTX.10</b>	9,19	E10	25	14,2	GA.20A	BA.20A	38	86
<b>NSTX.12</b>	10,95	E12	25	15,2	GA.20A	BA.20A	38	85
<b>NSTX.14</b>	12,67	E14	25	18,2	GA.20A	BA.20A	38	88
<b>NSTX.16</b>	14,70	E16	25	19,2	GA.20A	BA.20A	38	88
<b>NSTX.18</b>	16,38	E18	25	22,2	GA.20A	BA.20A	38	89
<b>NSTX.20</b>	18,16	E20	30	24,2	GA.24A	BA.24A	38	134
<b>NSTX.24</b>	21,84	E24	30	28,2	GA.24A	BA.24A	40	138

## ■ NSX 1/2" drive impact bits for Torx® heads

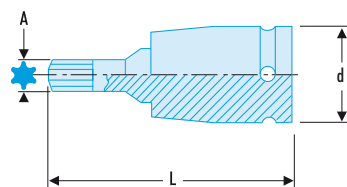

- For your safety, use impact sockets and accessories with the appropriate rings and pins.
- For Torx® male drive fasteners.

➤	A [mm]	Torx [No]	d [mm]	Bits	L [mm]	ΔΔ [g]
<b>NSX.30A</b>	5,49	T30	25	NEX.30A	70	90
<b>NSX.40A</b>	6,60	T40	25	NEX.40A	70	95
<b>NSX.45A</b>	7,77	T45	25	NEX.45A	70	95
<b>NSX.50A</b>	8,79	T50	25	NEX.50A	70	100
<b>NSX.55A</b>	11,17	T55	25	NEX.55A	70	105
<b>NSX.60A</b>	13,20	T60	25	NEX.60A	70	110

## ■ NSHM 1/2" drive metric impact bits for hexagon socket heads

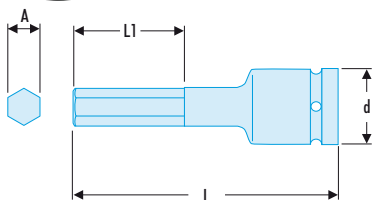

- For your safety, use impact sockets and accessories with the appropriate rings and pins.
- Monobloc driver socket.

➤	A [mm]	⊕ [mm]	d [mm]	GA	BA	L [mm]	L1 [mm]	ΔΔ [g]
<b>NSHM.5</b>	5	6	25	GA.20A	BA.20A	75	20	60
<b>NSHM.6</b>	6	6	25	GA.20A	BA.20A	75	20	60
<b>NSHM.8</b>	8	6	25	GA.20A	BA.20A	75	25	80
<b>NSHM.10</b>	10	6	25	GA.20A	BA.20A	75	25	100
<b>NSHM.12</b>	12	6	25	GA.20A	BA.20A	75	25	120
<b>NSHM.14</b>	14	6	25	GA.20A	BA.20A	75	25	120
<b>NSHM.17</b>	17	6	25	GA.20A	BA.20A	75	25	160
<b>NSHM.19</b>	19	6	25	GA.20A	BA.20A	75	25	180

## ■ NS.A - 1/2" impact bit holder sockets

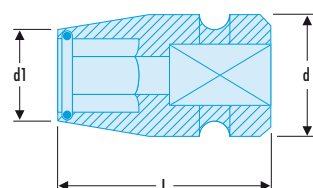

NF ISO 1711-2, ISO 1711-2, DIN 3121

- For 1/2" bits.
- NS.236: for 5/16" bits.
- NS.237: for 1/2" bits.

➤	A ["]	Square ["]	d [mm]	d1 [mm]	GA	BA	L [mm]	ΔΔ [g]
<b>NS.236A</b>	5/16	1/2	25	15,5	GA.20A	BA.20A	40	65
<b>NS.237A</b>	1/2	1/2	25	20	GA.20A	BA.20A	40	40

■ NS.A - 1/2" drive impact extensions

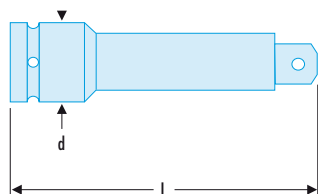

ASME B107.2

• For your safety, use impact extensions and accessories with the appropriate rings and pins.

➤	d [mm]	GA	BA	L [mm]	ΔΔ [g]
<b>NS.210A</b>	25	GA.20A	BA.20A	50	105
<b>NS.215A</b>	25	GA.20A	BA.20A	125	235
<b>NS.218A</b>	25	GA.20A	BA.20A	175	370
<b>NS.219A</b>	25	GA.20A	BA.20A	250	520

■ 1/2" drive impact universal joint

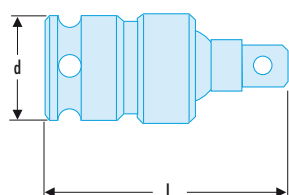

ASME B107.2

• For your safety, use impact universal joints with the appropriate rings and pins.

➤	d [mm]	GA	BA	L [mm]	ΔΔ [g]
<b>NS.240A</b>	27,9	GA.24A	BA.24A	60	205

■ 1/2" to 3/4" impact coupler

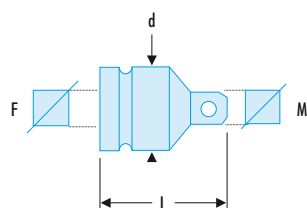

ASME B107.2

• For your safety, use impact couplers with the appropriate rings and pins.

➤	Square ["]	d [mm]	GA	BA	L [mm]	ΔΔ [g]
<b>NS.232B</b>	F = 1/2" - M = 3/4"	31	GA.24A	BA.25A	50	185

■ 1/2" to 3/8" impact coupler

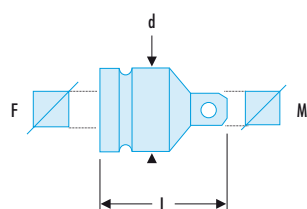

ASME B107.2

• For your safety, use impact sockets and accessories with the appropriate rings and pins.

➤	Square ["]	d [mm]	GA	BA	L [mm]	ΔΔ [g]
<b>NS.230A</b>	F = 1/2" - M = 3/8"	25	GA.20A	BA.20A	41	90

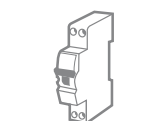
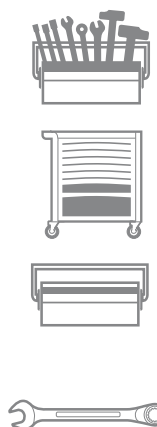



## ▣ **NK.500E** Set of 3/4" impact sockets 19 to 42 mm



- For your safety, use impact sockets and accessories with the appropriate rings and pins.
  - Comprising:
    - Sockets: NK.19A - NK.21A - NK.22A - NK.23A - NK.24A - NK.26A - NK.27A - NK.28A - NK.29A - NK.30A - NK.32A - NK.34A - NK.36A - NK.38A - NK.41A - NK.42A.
    - Rings: BA.38A.
    - Pins: GA.37A.
    - Accessories: NK.210A and NS.240A.
    - Metal case BT.111, dim. (L. x D. x H.): 396 x 224 x 82 mm.
    - Tray PL.79A.
- Weight: 12.40 kg.

## ▣ **NK.500U** Set of 3/4" impact sockets size 3/4" to 1"5/8



- For your safety, use impact sockets and accessories with the appropriate rings and pins.
  - Comprising:
    - Sockets: NK.1'1/16A - NK.1'1/2A - NK.1'1/4A - NK.1'1/8A - NK.13/16A - NK.15/16A - NK.1'5/16A - NK.1'5/8A - NK.1'7/16A - NK.1'A - NK.3/4A - NK.7/8A.
    - Pin: GA.37A.
    - Ring: BA.38A.
    - Accessories: NK.210A and NK.240A.
    - Metal case BT.111, dim.(L. x D. x H.): 396 x 224 x 82 mm.
    - Tray PL.80A.
- Weight: 10.30 kg.

## FACOM POWER TOOLS

### FACOM HAS A WIDE RANGE OF AIR AND PORTABLE ELECTRIC TOOLS,

Including impact wrenches, ratchets, screwdrivers, drills, grinders, sanders, power chisels, etc.

➤ See section 14 p.676



### Impact sockets 3/4" and accessories

#### ■ NK.A - 3/4" drive metric 6-point impact sockets

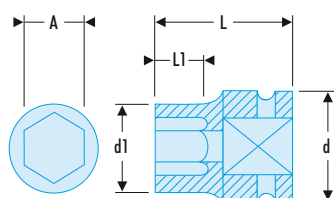

NF ISO 2725-2, NF ISO 1711-2, ISO 2725-2, ISO 1711-2, DIN 3129, ASME B107.33

• For your safety, use impact sockets and accessories with the appropriate rings and pins.

➤	A [mm]	⌀ [mm]	d [mm]	d1 [mm]	GA	BA	L [mm]	L1 [mm]	ΔΔ [g]
NK.17A	17	6	44	30	GA.37A	BA.38A	52	12	300
NK.18A	18	6	44	32	GA.37A	BA.38A	50	13	310
NK.19A	19	6	44	33	GA.37A	BA.38A	50	14	315
NK.21A	21	6	44	35	GA.37A	BA.38A	50	15	330
NK.22A	22	6	44	37	GA.37A	BA.38A	50	16	345
NK.23A	23	6	44	38	GA.37A	BA.38A	50	16	350
NK.24A	24	6	44	39	GA.37A	BA.38A	50	17	350
NK.26A	26	6	44	42	GA.37A	BA.38A	50	18	480
NK.27A	27	6	44	43	GA.37A	BA.38A	54	23	480
NK.28A	28	6	44	44	GA.37A	BA.38A	54	23	520
NK.29A	29	6	44	45	GA.37A	BA.38A	54	23	520
NK.30A	30	6	44	47	GA.37A	BA.38A	54	23	545
NK.32A	32	6	44	49	GA.37A	BA.38A	56	23	620
NK.33A	33	6	44	51	GA.37A	BA.38A	56	23	650
NK.34A	34	6	44	52	GA.37A	BA.38A	56	23	680
NK.35A	35	6	44	53	GA.37A	BA.38A	56	23	680
NK.36A	36	6	44	54	GA.37A	BA.38A	56	25	705
NK.38A	38	6	44	57	GA.37A	BA.38A	58	26	890
NK.41A	41	6	44	60	GA.37A	BA.38A	58	28	890
NK.42A	42	6	44	62	GA.37A	BA.38A	58	29	925
NK.46A	46	6	44	67	GA.37A	BA.38A	63	32	1055

#### ■ NK.A - 3/4" drive inch 6-point impact sockets

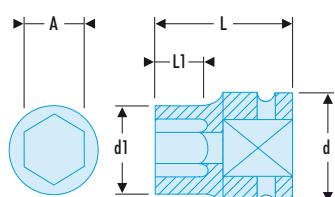

ASME B107.2

• For your safety, use impact sockets and accessories with the appropriate rings and pins.

➤	A ["]	⌀ [mm]	d [mm]	d1 [mm]	GA	BA	L [mm]	L1 [mm]	ΔΔ [g]
NK.3/4A	3/4	6	44	33	GA.37A	BA.38A	50	14	315
NK.13/16A	13/16	6	44	35	GA.37A	BA.38A	50	15	330
NK.7/8A	7/8	6	44	37	GA.37A	BA.38A	50	16	345
NK.15/16A	15/16	6	44	39	GA.37A	BA.38A	50	17	350
NK.1"A	1"	6	44	41	GA.37A	BA.38A	50	18	480
NK.1"1/16A	1" 1/16	6	44	43	GA.37A	BA.38A	54	23	480
NK.1"1/8A	1" 1/8	6	44	44	GA.37A	BA.38A	54	23	520
NK.1"1/4A	1" 1/4	6	44	49	GA.37A	BA.38A	56	23	620
NK.1"5/16A	1" 5/16	6	44	53	GA.37A	BA.38A	56	23	680
NK.1"7/16A	1" 7/16"	6	44	55	GA.37A	BA.38A	56	24	515
NK.1"1/2A	1" 1/2	6	44	57	GA.37A	BA.38A	58	26	890
NK.1"5/8A	1" 5/8	6	44	60	GA.37A	BA.38A	58	28	890

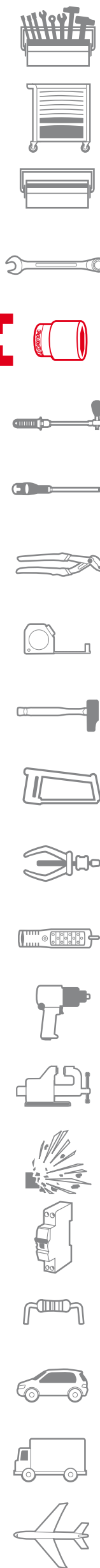

## █ NKD - 3/4" drive metric 12-point impact sockets

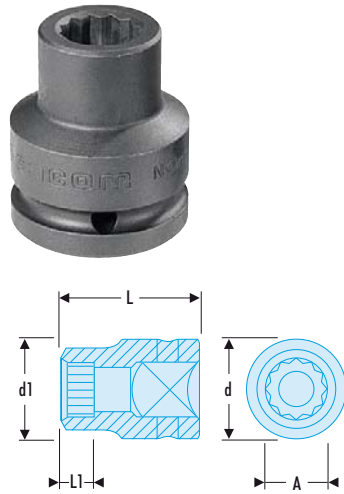

NF ISO 2725-2, NF ISO 1711-2, ISO 2725-2, ISO 1711-2, DIN 3129, ASME B107.33

• For your safety, use impact sockets and accessories with the appropriate rings and pins.

⇒	A [mm]	⊕ [mm]	d [mm]	d1 [mm]	GA	BA	L [mm]	L1 [mm]	ΔΔ [g]
<b>NKD.16A</b>	16	12	44	29,0	GA.37A	BA.38A	52	12	300
<b>NKD.17A</b>	17	12	44	30,0	GA.37A	BA.38A	52	12	305
<b>NKD.18A</b>	18	12	44	31,5	GA.37A	BA.38A	52	14	310
<b>NKD.19A</b>	19	12	44	32,5	GA.37A	BA.38A	52	14	315
<b>NKD.22A</b>	22	12	44	36,5	GA.37A	BA.38A	52	16	340

## █ NK.LA - 3/4" drive metric long-reach metric 6-point impact sockets



NF ISO 2725-2, NF ISO 1711-2, ISO 2725-2, ISO 1711-2, DIN 3129, ASME B107.33

• For your safety, use impact sockets and accessories with the appropriate rings and pins.

⇒	A [mm]	⊕ [mm]	d [mm]	d1 [mm]	GA	BA	L [mm]	L1 [mm]	ΔΔ [g]
<b>NK.17LA</b>	17	6	44	31	GA.37A	BA.38A	95	17	550
<b>NK.19LA</b>	19	6	44	33	GA.37A	BA.38A	95	17	620
<b>NK.21LA</b>	21	6	44	35	GA.37A	BA.38A	95	24	600
<b>NK.22LA</b>	22	6	44	37	GA.37A	BA.38A	95	24	780
<b>NK.23LA</b>	23	6	44	38	GA.37A	BA.38A	95	24	780
<b>NK.24LA</b>	24	6	44	39	GA.37A	BA.38A	95	24	820
<b>NK.26LA</b>	26	6	44	42	GA.37A	BA.38A	95	24	800
<b>NK.27LA</b>	27	6	44	43	GA.37A	BA.38A	95	24	810
<b>NK.29LA</b>	29	6	44	45	GA.37A	BA.38A	95	24	890
<b>NK.30LA</b>	30	6	44	47	GA.37A	BA.38A	95	24	900
<b>NK.32LA</b>	32	6	44	49	GA.37A	BA.38A	95	24	930
<b>NK.33LA</b>	33	6	44	51	GA.37A	BA.38A	95	24	980
<b>NK.34LA</b>	34	6	44	52	GA.37A	BA.38A	95	24	1100
<b>NK.35LA</b>	35	6	44	53	GA.37A	BA.38A	95	24	1240
<b>NK.36LA</b>	36	6	44	54	GA.37A	BA.38A	95	25	1240
<b>NK.38LA</b>	38	6	44	57	GA.37A	BA.38A	95	60	1220
<b>NK.41LA</b>	41	6	44	60	GA.37A	BA.38A	95	60	1470
<b>NK.42LA</b>	42	6	44	62	GA.37A	BA.38A	95	60	1450
<b>NK.46LA</b>	46	6	44	67	GA.37A	BA.38A	95	60	1480

## █ NKB - 3/4" drive long-reach metric thin-wall 6-point impact sockets



NF ISO 2725-2, NF ISO 1711-2, ISO 2725-2, ISO 1711-2, DIN 3129, ASME B107.33

- For your safety, use impact sockets and accessories with the appropriate rings and pins.
- Thin wall for better access.
- 6-point convex pattern for increased resilience.

⇒	A [mm]	⊕ [mm]	d1 [mm]	GA	BA	L [mm]	L1 [mm]	ΔΔ [g]
<b>NKB.21</b>	21	6	33	GA.37A	BA.38A	102	21	600
<b>NKB.22</b>	22	6	34	GA.37A	BA.38A	102	22	600
<b>NKB.24</b>	24	6	36	GA.37A	BA.38A	102	24	640
<b>NKB.27</b>	27	6	40	GA.37A	BA.38A	102	27	670
<b>NKB.30</b>	30	6	43	GA.37A	BA.38A	102	30	700
<b>NKB.32</b>	32	6	46	GA.37A	BA.38A	102	32	706
<b>NKB.33</b>	33	6	48	GA.37A	BA.38A	102	33	750
<b>NKB.36</b>	36	6	50	GA.37A	BA.38A	102	36	765

### ■ NKHM - 3/4" drive metric impact bits for hexagon socket head

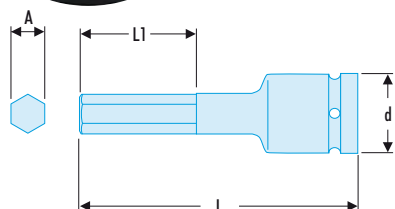

- For your safety, use impact sockets and accessories with the appropriate rings and pins.
- Non-removable bits.

➤	A [mm]	⌀ [mm]	d [mm]	GA	BA	L [mm]	L1 [mm]	ΔΔ [g]
<b>NKHM.17</b>	17	6	44	GA.37A	BA.38A	100	20	600
<b>NKHM.19</b>	19	6	44	GA.37A	BA.38A	100	20	600
<b>NKHM.22</b>	22	6	44	GA.37A	BA.38A	100	20	600
<b>NKHM.24</b>	24	6	44	GA.37A	BA.38A	100	20	600

### ■ NK.A - 3/4" drive impact extensions

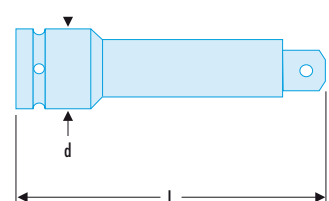

#### ASME B107.2

- For your safety, use impact extensions and accessories with the appropriate rings and pins.

➤	d [mm]	GA	BA	L [mm]	ΔΔ [g]
<b>NK.209A</b>	44	GA.37A	BA.38A	100	600
<b>NK.210A</b>	44	GA.37A	BA.38A	175	105
<b>NK.215A</b>	44	GA.37A	BA.38A	252	117
<b>NK.218A</b>	44	GA.37A	BA.38A	330	151



### ■ 3/4" drive impact universal joint

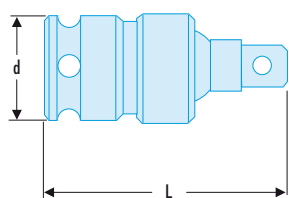

#### ASME B107.2

- For your safety, use impact universal joints with the appropriate rings and pins.

➤	d [mm]	GA	BA	L [mm]	ΔΔ [g]
<b>NK.240A</b>	44	GA.37A	BA.38A	90	720

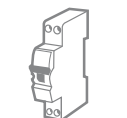

# "Impact" range

## 3/4" to 1/2" impact coupler

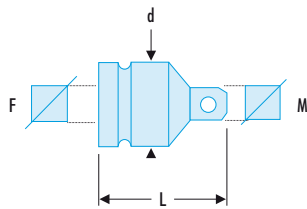

### ASME B107.2

• For your safety, use impact couplers with the appropriate rings and pins.

➤	Square ["]	d [mm]	GA	BA	L [mm]	ΔΔ [g]
<b>NK.230A</b>	F = 3/4" - M = 1"	54	GA.37A	BA.38A	75	210

## 3/4" to 1" impact coupler

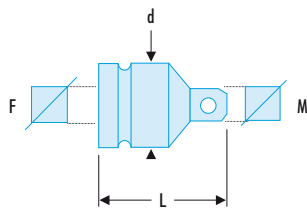

### ASME B107.2

• For your safety, use impact sockets and accessories with the appropriate rings and pins.

➤	Square ["]	d [mm]	GA	BA	L [mm]	ΔΔ [g]
<b>NK.232A</b>	F = 3/4" - M = 1"	43	GA.37A	BA.38A	71	525

## Impact sockets 1" and accessories

### NM.A - 1" drive metric 6-point impact sockets

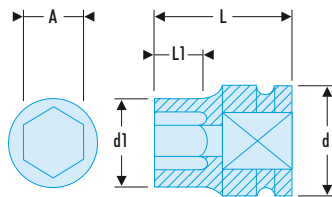

### NF ISO 2725-2, NF ISO 1711-2, ISO 2725-2, ISO 1711-2, DIN 3129, ASME B107.33

• For your safety, use impact sockets and accessories with the appropriate rings and pins.

➤	A [mm]	⊙ [mm]	d [mm]	d1 [mm]	GA	BA	L [mm]	L1 [mm]	ΔΔ [kg]
<b>NM.21A</b>	21	6	54	38	GA.43A	BA.46A	58	17	0,520
<b>NM.22A</b>	22	6	54	40	GA.43A	BA.46A	58	17	0,500
<b>NM.23A</b>	23	6	54	41	GA.43A	BA.46A	58	17	0,500
<b>NM.24A</b>	24	6	54	42	GA.43A	BA.46A	58	17	0,500
<b>NM.26A</b>	26	6	54	44	GA.43A	BA.46A	58	18	0,520
<b>NM.27A</b>	27	6	54	46	GA.43A	BA.46A	58	19	0,520
<b>NM.28A</b>	28	6	54	47	GA.43A	BA.46A	58	20	0,520
<b>NM.29A</b>	29	6	54	48	GA.43A	BA.46A	60	20	0,520
<b>NM.30A</b>	30	6	54	50	GA.43A	BA.46A	60	20	0,750
<b>NM.32A</b>	32	6	54	52	GA.43A	BA.46A	60	22	0,760
<b>NM.33A</b>	33	6	54	53	GA.43A	BA.46A	60	22	0,750
<b>NM.34A</b>	34	6	54	55	GA.43A	BA.46A	62	23	0,750
<b>NM.35A</b>	35	6	54	56	GA.43A	BA.46A	62	26	0,800
<b>NM.36A</b>	36	6	54	57	GA.43A	BA.46A	65	26	0,840
<b>NM.38A</b>	38	6	54	60	GA.43A	BA.46A	65	30	0,840
<b>NM.41A</b>	41	6	54	63	GA.43A	BA.46A	67	30	1,040
<b>NM.42A</b>	42	6	54	65	GA.43A	BA.46A	74	35	1,040
<b>NM.46A</b>	46	6	54	70	GA.43A	BA.46A	74	35	1,500
<b>NM.50A</b>	50	6	54	75	GA.43A	BA.46A	80	40	1,650
<b>NM.52A</b>	52	6	54	77	GA.43A	BA.46A	84	42	1,750
<b>NM.54A</b>	54	6	54	80	GA.43A	BA.46A	84	42	1,790
<b>NM.55A</b>	55	6	54	81	GA.43A	BA.46A	84	42	1,840
<b>NM.56A</b>	56	6	54	82	GA.43A	BA.46A	84	42	2,060
<b>NM.58A</b>	58	6	54	85	GA.43A	BA.46A	87	44	2,190
<b>NM.60A</b>	60	6	54	87	GA.43A	BA.46A	87	44	2,370
<b>NM.65A</b>	65	6	54	93	GA.43A	BA.46A	90	46	2,730
<b>NM.70A</b>	70	6	54	100	GA.43A	BA.46A	96	50	2,980
<b>NM.75A</b>	75	6	86	106	GA.75A	BA.75A	98	50	3,300
<b>NM.77A</b>	77	6	86	109	GA.75A	BA.75A	100	50	3,500

### ■ NM.A - 1" drive inch 6-point impact sockets

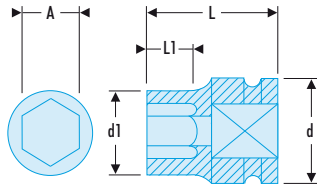

#### ASME B107.2

- For your safety, use impact sockets and accessories with the appropriate rings and pins.

➤	A ["]	⌀ [mm]	d [mm]	d1 [mm]	GA	BA	L [mm]	L1 [mm]	ΔΔ [kg]
NM.1'A	1"	6	54	44	GA.43A	BA.46A	58	18	0,520
NM.1'1/8A	1 1/8"	6	54	48	GA.43A	BA.46A	60	20	0,520
NM.1'1/4A	1 1/4"	6	54	52	GA.43A	BA.46A	60	22	0,760
NM.1'5/16A	1 5/16"	6	54	54	GA.43A	BA.46A	62	22	0,750
NM.1'1/2A	1 1/2"	6	54	60	GA.43A	BA.46A	65	30	1,620
NM.1'5/8A	1 5/8"	6	54	63	GA.43A	BA.46A	67	30	1,040
NM.1'13/16A	1 13/16"	6	54	70	GA.43A	BA.46A	74	35	1,500
NM.1'7/8A	1 7/8"	6	54	72	GA.43A	BA.46A	74	35	1,620
NM.2'A	2"	6	54	77	GA.43A	BA.46A	84	42	1,750
NM.2'1/8A	2 1/8"	6	54	80	GA.43A	BA.46A	84	42	1,790

### ■ NM.LA - 1" drive long-reach metric 6-point impact sockets

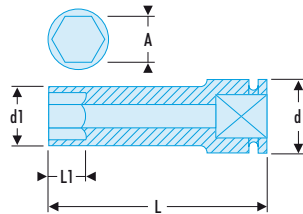

#### NF ISO 2725-2, NF ISO 1711-2, ISO 2725-2, ISO 1711-2, DIN 3129, ASME B107.33

- For your safety, use impact sockets and accessories with the appropriate rings and pins.

➤	A [mm]	⌀ [mm]	d [mm]	d1 [mm]	GA	BA	L [mm]	L1 [mm]	ΔΔ [kg]
NM.22LA	22	6	54	40,0	GA.43A	BA.46A	100	21	1,000
NM.23LA	23	6	54	41,0	GA.43A	BA.46A	100	21	1,050
NM.24LA	24	6	54	42,0	GA.43A	BA.46A	100	21	1,050
NM.26LA	26	6	54	44,5	GA.43A	BA.46A	100	24	1,080
NM.27LA	27	6	54	46,0	GA.43A	BA.46A	100	24	1,120
NM.29LA	29	6	54	48,0	GA.43A	BA.46A	100	24	1,200
NM.30LA	30	6	54	50,0	GA.43A	BA.46A	100	24	1,200
NM.32LA	32	6	54	52,0	GA.43A	BA.46A	100	24	1,250
NM.33LA	33	6	54	53,0	GA.43A	BA.46A	100	24	1,320
NM.34LA	34	6	54	55,0	GA.43A	BA.46A	100	40	1,320
NM.35LA	35	6	54	56,0	GA.43A	BA.46A	100	60	1,340
NM.36LA	36	6	54	57,0	GA.43A	BA.46A	100	65	1,500
NM.38LA	38	6	54	60,0	GA.43A	BA.46A	100	65	1,500
NM.41LA	41	6	54	63,0	GA.43A	BA.46A	100	64	1,650
NM.42LA	42	6	54	65,0	GA.43A	BA.46A	100	64	1,650
NM.46LA	46	6	54	70,0	GA.43A	BA.46A	100	63	1,560
NM.50LA	50	6	54	75,0	GA.43A	BA.46A	100	62	1,870
NM.54LA	54	6	54	80,0	GA.43A	BA.46A	100	61	1,780
NM.55LA	55	6	54	81,0	GA.43A	BA.46A	100	60	1,930
NM.58LA	58	6	54	85,0	GA.43A	BA.46A	105	65	2,120
NM.60LA	60	6	54	87,0	GA.43A	BA.46A	120	78	2,180
NM.65LA	65	6	54	93,0	GA.43A	BA.46A	125	80	2,250
NM.70LA	70	6	54	100,0	GA.43A	BA.46A	125	80	2,230

### ■ NMB - Long-reach 6-point thin-wall sockets

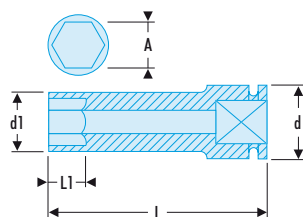

#### NF ISO 2725-2, NF ISO 1711-2, ISO 2725-2, ISO 1711-2, DIN 3129, ASME B107.33

- Thin wall for better access.
- For your safety, use impact sockets and accessories with the appropriate rings and pins.
- 6-point convex pattern for increased resilience.

➤	A [mm]	⌀ [mm]	d [mm]	d1 [mm]	GA	BA	L [mm]	L1 [mm]	ΔΔ [kg]
NMB.24	24	6	54	38	GA.43A	BA.46A	108	24	0,940
NMB.27	27	6	54	42	GA.43A	BA.46A	108	27	1,000
NMB.30	30	6	54	46	GA.43A	BA.46A	108	30	1,040
NMB.32	32	6	54	48	GA.43A	BA.46A	108	32	1,040
NMB.33	33	6	54	49	GA.43A	BA.46A	108	33	1,050
NMB.36	36	6	54	53	GA.43A	BA.46A	108	36	1,080
NMB.46	46	6	54	66	GA.43A	BA.46A	108	38	1,480
NMB.50	50	6	54	74	GA.43A	BA.46A	108	66	1,480

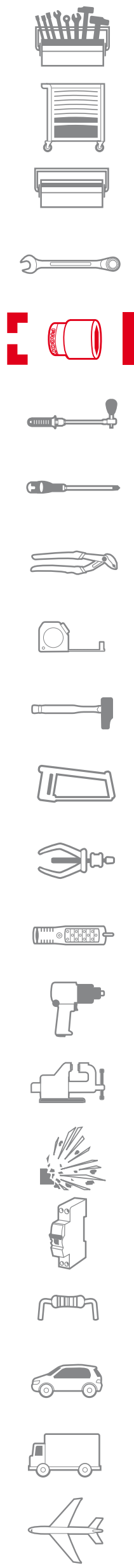

## ■ NM.ELA - 1" drive extra-long reach metric 6-point impact sockets

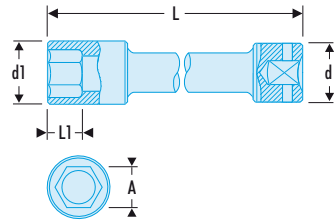

- For your safety, use impact extensions and accessories with the appropriate rings and pins.

☞	A [mm]	⌀ [mm]	d [mm]	d1 [mm]	GA	BA	L [mm]	L1 [mm]	ΔΔ [kg]
<b>NM.30ELA</b>	30	6	54	50	GA.43A	BA.46A	270	30	2,50
<b>NM.32ELA</b>	32	6	54	52	GA.43A	BA.46A	270	32	2,56
<b>NM.33ELA</b>	33	6	54	53	GA.43A	BA.46A	270	32	2,56

## ■ Special "Trailer" 1" drive metric impact sockets

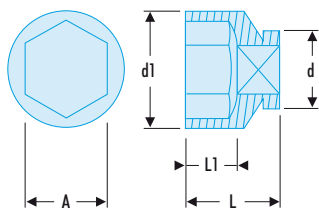

- For your safety, use impact extensions and accessories with the appropriate rings and pins.
- For 77 mm 6-point trailer hub nut.

☞	A [mm]	d [mm]	d1 [mm]	L [mm]	L1 [mm]	ΔΔ [kg]
<b>M.77TR</b>	77	54	106	81	35	1,96

## ■ NM.A - 1" drive impact extensions

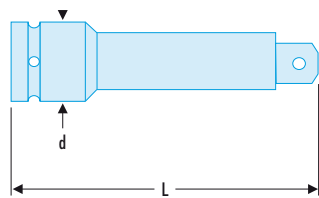

### ASME B107.2

- For your safety, use impact couplers with the appropriate rings and pins.

☞	d [mm]	GA	BA	L [mm]	ΔΔ [kg]
<b>NM.209A</b>	54	GA.43A	BA.46A	125	1,20
<b>NM.210A</b>	54	GA.43A	BA.46A	200	1,60
<b>NM.215A</b>	54	GA.43A	BA.46A	330	2,50



### 1" drive impact universal joint

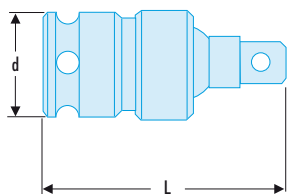

#### ASME B107.2

- For your safety, use impact couplers with the appropriate rings and pins.

➤	d [mm]	GA	BA	L [mm]	ΔΔ [kg]
<b>NM.240A</b>	54	GA.43A	BA.46A	110	2,00

### NM.A - 1" to 3/4" impact couplers

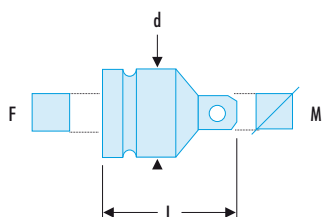

#### ASME B107.2

- For your safety, use impact couplers with the appropriate rings and pins.

➤	Square ["]	d [mm]	GA	BA	L [mm]	ΔΔ [kg]
<b>NM.230A</b>	F = 1" - M = 3/4"	54	GA.38	BA.36	75	0,540
<b>NM.231A</b>	F = 1" - M = 1/2"	51	GA.38	BA.36	154	1,040

### 1" to 1/2" impact coupler



#### ASME B107.2

- For your safety, use impact couplers with the appropriate rings and pins.

➤	GA	BA	ΔΔ [kg]
<b>NM.232A</b>	GA.43A	BA.46A	1,50

## Impact sockets 1" 1/2 and accessories

### NG.A - 1 1/2" drive metric 6-point impact sockets

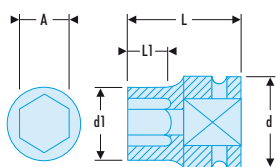

#### NF ISO 2725-2, NF ISO 1711-2, ISO 2725-2, ISO 1711-2, DIN 3129, ASME B107.33

- For your safety, use impact sockets and accessories with the appropriate rings and pins.

➤	A [mm]	⌀ [mm]	d [mm]	d1 [mm]	GA	BA	L [mm]	L1 [mm]	ΔΔ [kg]
<b>NG.55A</b>	55	6	86	87	GA.75A	BA.75A	90	38	2,520
<b>NG.60A</b>	60	6	86	94	GA.75A	BA.75A	92	38	2,870
<b>NG.65A</b>	65	6	86	100	GA.75A	BA.75A	95	40	3,180
<b>NG.70A</b>	70	6	86	106	GA.75A	BA.75A	100	43	3,750
<b>NG.75A</b>	75	6	86	112	GA.75A	BA.75A	103	45	3,930
<b>NG.80A</b>	80	6	86	119	GA.75A	BA.75A	110	51	4,610
<b>NG.85A</b>	85	6	86	125	GA.75A	BA.75A	118	52	5,380
<b>NG.90A</b>	90	6	86	131	GA.75A	BA.75A	118	52	5,650
<b>NG.95A</b>	95	6	95	137	GA.84A	BA.85A	118	52	6,590
<b>NG.100A</b>	100	6	95	144	GA.84A	BA.85A	125	59	7,420
<b>NG.105A</b>	105	6	95	150	GA.84A	BA.85A	125	59	7,830
<b>NG.110A</b>	110	6	95	156	GA.84A	BA.85A	125	59	8,600
<b>NG.115A</b>	115	6	95	162	GA.84A	BA.85A	135	67	9,730
<b>NG.120A</b>	120	6	95	169	GA.84A	BA.85A	135	67	9,480

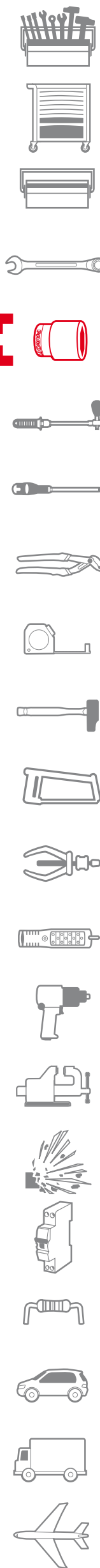



# "Impact" range

## NG.A - 1 1/2" drive impact extensions

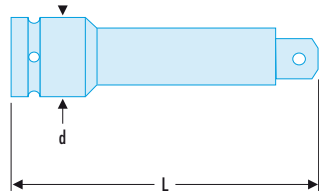

### ASME B107.2

• For your safety, use impact extensions and accessories with the appropriate rings and pins.

➤	d [mm]	GA	BA	L [mm]	ΔΔ [kg]
<b>NG.210A</b>	86	GA.75A	BA.75A	250	5,60
<b>NG.215A</b>	86	GA.75A	BA.75A	330	6,80

## 1 1/2" impact universal joint

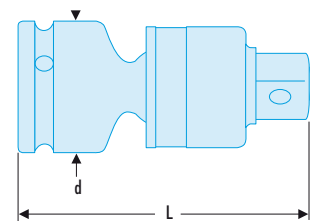

### ASME B107.2

• For your safety, use impact universal joints with the appropriate rings and pins.

➤	d [mm]	GA	BA	L [mm]	ΔΔ [kg]
<b>NG.240A</b>	86	GA.75A	BA.75A	181	4,20

## 1 1/2" to 2 1/2" impact coupler

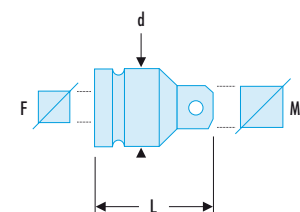

### ASME B107.2

• For your safety, use impact universal joints with the appropriate rings and pins.

➤	Square ["]	d [mm]	GA	BA	L [mm]	ΔΔ [kg]
<b>NG.232A</b>	F = 1 1/2 - M = 2 1/2	86	GA.75A	BA.75A	120	3,90

## 1 1/2" to 1" impact coupler

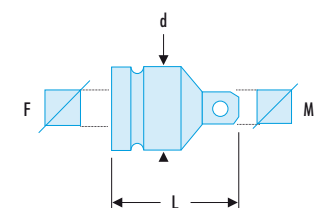

### ASME B107.2

• For your safety, use impact universal joints with the appropriate rings and pins.

➤	Square ["]	d [mm]	GA	BA	L [mm]	ΔΔ [kg]
<b>NG.230A</b>	F = 1 1/2 - M = 1"	80	GA.75A	BA.75A	98	2,166

## 3/4" drive Dynapact manual impact wrench

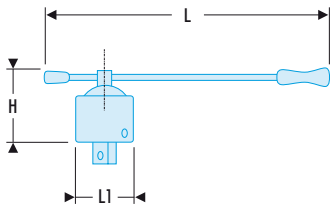

- Stored energy frees or secures very tight fasteners.
- Handle rotation through 60° (approx.) releases torque.
- 10 impacts on 21 mm A/F equate to 1000 N.m.

- Dynapact handle: NK.300M.

Model	H [mm]	L [mm]	L1 [mm]	ΔΔ [kg]
<b>NK.300</b>	105	470	96	4,00

## NK.301AE 3/4" drive Dynapact manual impact wrench set



- Comprising:
  - Wrench NK.300 and 16 tools with locking rings and pins.
  - Sockets: NK.19A - NK.21A - NK.22A - NK.23 A - NK.24A - NK.26A - NK.27A - NK.29A - NK.30A - NK.32A - NK.34A - NK.36A - NK.38A - NK.41A - NK.42A.
  - Extension: NK.210A.
  - Metal case BT.103G, dim. (L. x D. x H.): 643 x 224 x 111 mm.
  - Tray PL.84A.
- Weight: 16.70 kg.

## 1" drive Dynapact manual impact wrench

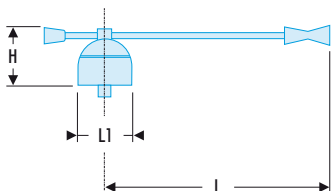
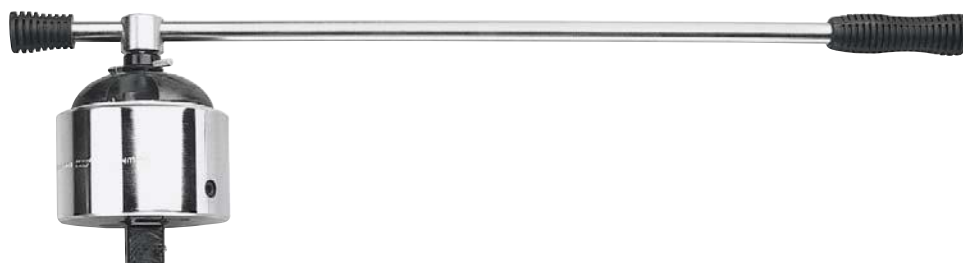

- Stored energy frees or secures very tight fasteners.
- Handle rotation through 60° (approx.) releases torque.
- 10 impacts on 21 mm A/F equate to 2000 N.m.

- Dynapact handle: NM.300M.

Model	H [mm]	L [mm]	L1 [mm]	ΔΔ [kg]
<b>NM.300</b>	140	595	125	10,80

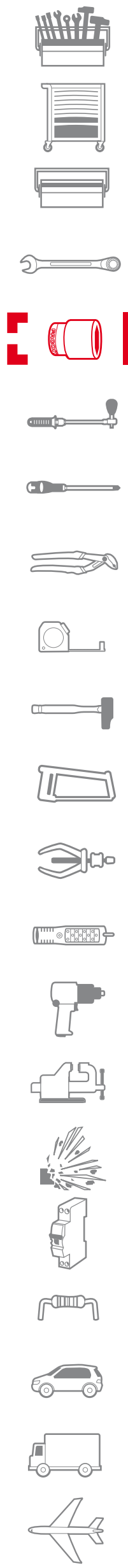

志發

CHEE FATT

W : [www.cheefatt.com](http://www.cheefatt.com)

E : [marketing@cheefatt.com](mailto:marketing@cheefatt.com)

T : +65 6294 2066