



SAWING



586

Hacksaw frame.....	586
Hacksaw blades	589

FILES



590

File sets.....	592
Engineers files.....	593
Wood rasps.....	598
Precision files.....	599

WORKSHOP DRILL BITS, TAPS AND DIES

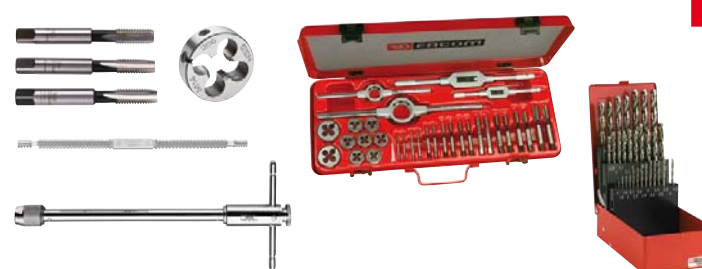

600

Taps	600
Dies.....	601
Threading and tapping tool sets.....	602
Thread restoring tools.....	602
Tools for taps and dies.....	603
Workshop drill bits.....	604
Bits for impact machinery.....	606

HOLESAWS



606

Variable pitch hole saws	606
Hole saw sets	607

MILLS, SCRAPERS



608

Mills	608
Scrapers.....	608



METAL SHEARS



610

Metal shears..... 610

BOLT CROPPERS



612

Forged arms bolt croppers..... 612
Tubular arms bolt croppers..... 613

CABLE CUTTERS



614

Copper and aluminium cable cutters..... 614
Steel cable cutters..... 615

UTILITY KNIVES



617

Utility knives..... 617
Utility knife blades..... 619
Multipurpose cutters..... 621

SCISSORS



621

Scissors..... 621

KNIVES



622

Knives..... 622

PUNCH KIT



624

Punch kit..... 624

Hacksaw frame

HIGH PERFORMANCE HACKSAW FRAME 603F

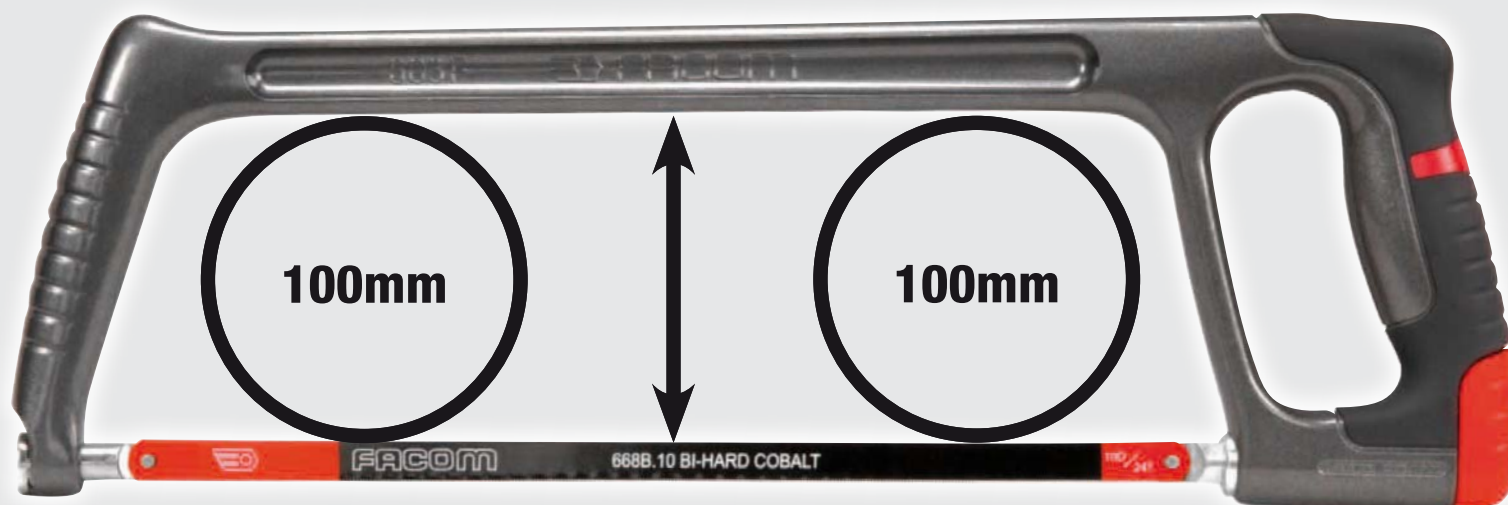

OPTIMUM AND DURABLE CUT

- Constant blade tension: 110 kg controlled automatically.
- Rigid aluminium bow.
- Bi-material ergonomic handle to reduce vibrations.

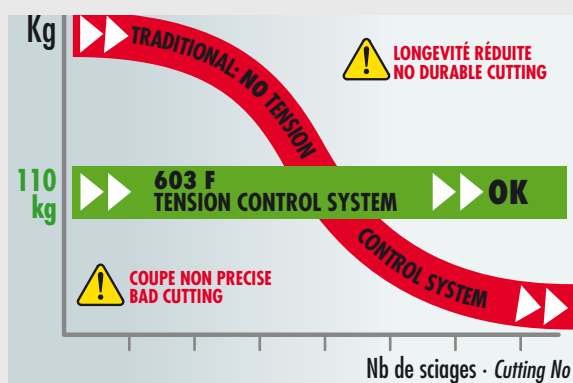

Exact cutting

- For a perfect tension control (110 kg), turn the button till CLACK.

SAVE TIME

- Cutting capacity 100 mm over the full bow length.
- Ultra-fast blade changing.
- 8 cutting positions (every 45°).



- 360°
- 8 positions



603F «High performance» hacksaw frame



NF E 73-073, DIN 6473

- Optimum and durable automatic blade tension control at 110 kg.
- Aluminium bow for maximum stiffness.
- Ergonomic handle for maximum cutting comfort.
- 8 blade positions.
- Ultra-fast blade changing.
- Takes 300 mm blade.
- Dimensions (L. x W.): 440 x 145 mm.
- Supplied with one blade.
- Weight: 830 g.
- Spare blades: 668B.

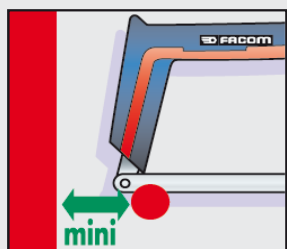
"TRAVELLING" HACKSAW FRAME 601**PRACTICAL AND COMPACT**

Minimum clearance to start cutting.

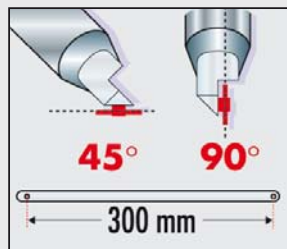

2 blade positions on machined and shouldered pins.

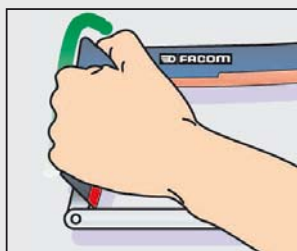

Left-hand rest.



Compact: stored in a 5-compartment box and in roller-cabinet modules.

**601 Compact hacksaw frame****NF E 73-073, DIN 6473**

- Impact-resistant steel/resin construction compact and lightweight.
 - Blade tension 80 kg.
 - 2 blade positions: 45° and 90°.
 - Takes 300 mm blade.
 - Dimensions (L. x W.): 385 x 145 mm.
 - Supplied with one blade.
- Weight: 590 g.
- Spare blades: 668B.

MOD.601 Saw, tape measure and files module

- Comprising:
 - 601: Hacksaw frame.
 - 666B.10 10: Saw blades (10 teeth per cm).
 - 234.S: Scriber.
 - 803.300M: Stainless steel 2-face rule 300 mm.
 - 893.316: Tape measure 3m.
 - 5 files with handle: PAM.B250EMA (flat bastard file) - DRD. MD250EMA (half-round, half-smooth) - CAR.MD200EMA (square file, half-smooth) - TRI.MD200EMA (triangular file, half-smooth) - RD.MD200EMA (round file, half-smooth).
 - Tray PL.335.
- Weight: 2.300 kg.

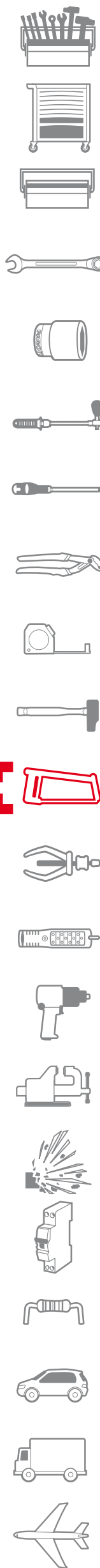

□ Straight frame with blade backing

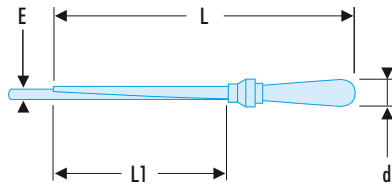

- Blade can be set to protrude beyond the backing to allow insertion into narrow gaps.
- Takes 300 mm blade.
- Spare blades: 668B.

🔪	d [mm]	E [mm]	L [mm]	L1 [mm]	ΔΔ [g]
606A	33	16	350	190	410

□ Revolver frame with sliding blade-guide

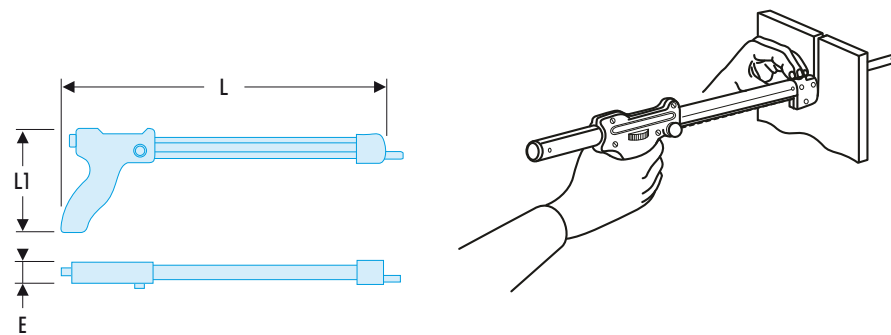

- Sliding guide steadies blade throughout cutting stroke.
- A thumbscrew can lock the guide to keep blade end clear.
- Takes 300 mm blade.
- Spare blades: 668B.

🔪	E [mm]	L [mm]	L1 [mm]	ΔΔ [g]
605.B	30	370	130	780

□ Flat bow frame - adjuster fitting

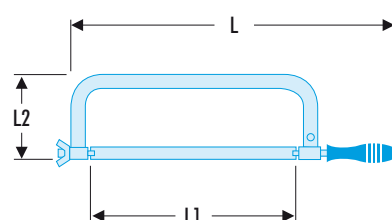

NF E 73-073, DIN 6473,

- Wood handle.
- Takes 300 mm blade.
- Spare blades: 668B.

🔪	L [mm]	L1 [mm]	L2 [mm]	ΔΔ [g]
599	520	300	130	600

Hacksaw blades

NEW HACKSAW BLADES 668B



Made from cobalt steel

- Higher heat resistance, reduced teeth wear.
- Equal performance throughout blade lifecycle.
- Enhanced flexibility and neater cut.
- Suited to all materials.
- Available in 8, 10 and 12 teeth.



668B - Cobalt steel bimetal saw blades



NF E 73-072, ISO 2336-1, DIN 6494

- Characteristics:
 - 668B.8: for thick semi-hard steels - thickness recommended: 6 - 25 mm.
 - 668B.10: for special or alloy steels - thickness recommended: 3 - 6 mm.
 - 668B.12: for stainless steel, copper - thickness recommended: 1 - 3 mm.
- Blade in cobalt steel: higher heat resistance, reduced teeth wear.
- Equal performance throughout blade lifecycle.
- Enhanced flexibility and neater cut.
- Suited to all materials.
- Blade length 300 mm.

FACOM	Teeth [°]	Teeth [cm]	ΔΔ [g]
668B.8	18	8	160
668B.10	24	10	160
668B.12	32	12	160

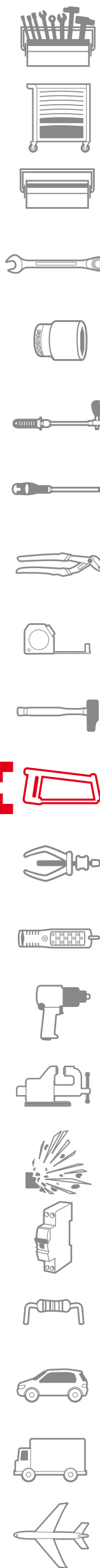

FILE SELECTION GUIDE

Facom technical specifications

- Made from high carbon-content steels.
- Optimum heat treatment for each application.
 - 64 to 66 HRC for engineers files.
 - 53 to 56 HRC for rasps.
 - 65 to 67 HRC for sharpening files.

File selection guide





Four criteria apply :

1. Shape or cross-section.
2. Pattern according to material.
3. Grade according to operation.



- Standard files:
 - B: Bastard cut for rough filing.
 - MD: Second cut for general purpose.
- Precision files:
 - TOA: Bastard cut for rough filing.
 - T2A: for normal smooth filing.

4. File length.

- Lengths quoted are always without tang.

Main shapes		
FLAT PAM 	HALF-ROUND DRD 	ROUND RD 
THREE-SQUARE TRI 		SQUARE CAR 

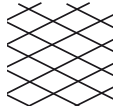
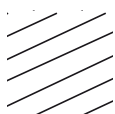
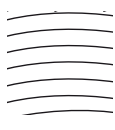

Pattern selection according to material		Steel	Cast Iron	Brass	Hard plastics, wood etc.	Aluminium and soft materials
Double cut for steel and metals. 		●	●	●	●	
Single cut for good surface finish, sharpening saws, lathe filling and fitters' requirements. 		●				
Dreadnaught, for soft materials, sheet metal, etc. Leaves a smooth finish. 		●		●	●	●
Rasp for soft materials and wood. Produces a rough surface. 					●	●

SELECTION GUIDE: WOOD HANDLES FOR FILES AND RASPS



Files	100 mm	125 mm	150 mm	200 mm	250 mm	300 mm
PAM: Flat hand	MAN.3	-	MAN.3	MAN.2	MAN.1	MAN.0
DRD: Half-round	MAN.3	-	MAN.3	MAN.2	MAN.1	MAN.0
TRI: Three-square	MAN.4	MAN.3	MAN.3	MAN.2	MAN.1	MAN.1
RD: Round	MAN.4	MAN.4	MAN.4	MAN.3	MAN.2	MAN.0
CAR: Square	MAN.4	MAN.4	MAN.4	MAN.3	MAN.2	MAN.1
CT: Knife	MAN.3	MAN.3	MAN.2	MAN.2	MAN.1	MAN.1
PIL: Pillar	MAN.3	-	MAN.2	MAN.2	MAN.1	-
PDE: Fat warding	MAN.3	MAN.3	MAN.2	MAN.2	MAN.1	MAN.1
BAR: Barette	MAN.3	-	MAN.2	MAN.2	MAN.1	-
FRC / FRO: Tapered	-	-	-	-	-	MAN.0
TRO: Round for chainsaws	-	-	MAN.4	MAN.4	-	-
Type of rasps	100 mm	125 mm	150 mm	200 mm	250 mm	300 mm
RAB.DRD: Half-round	-	-	-	-	MAN.1	MAN.0
RAB.P: Flat	-	-	-	-	MAN.1	MAN.0
RAB.RD: Round	-	-	-	-	MAN.1	MAN.0



MAN - Wood handles for files and rasps



- Varnished wood handles with nickel-plated steel ferrule.
- Supplied singly.

➤	d [mm]	L [mm]	[g]
MAN.0	34	132	55
MAN.1	32	124	45
MAN.2	28	110	40
MAN.3	25	102	30
MAN.4	22	98	25

SELECTION GUIDE: PLASTIC HANDLES FOR FILES AND RASPS



Files	100 mm	125 mm	150 mm	200 mm	250 mm	300 mm
PAM: Flat hand	MP.4	-	MP.3	MP.2	MP.1	MP.0
DRD: Half-round	MP.4	-	MP.3	MP.2	MP.1	MP.0
TRI: Three-square	-	-	MP.3	MP.1	MP.0	MP.0
RD: Round	MP.4	MP.4	MP.4	MP.3	MP.1	MP.0
CAR: Square	-	-	MP.4	MP.3	MP.1	MP.0
CT: Knife	MP.4	-	MP.3	MP.2	MP.1	-
PIL: Pillar	MP.4	-	MP.3	MP.2	MP.1	-
PDE: Fat warding	MP.4	-	MP.3	MP.2	MP.1	-
BAR: Barette	MP.4	-	MP.3	MP.2	MP.1	-
FRC / FRO: Tapered	-	-	-	-	-	MP.0
TRO: Round for chainsaws	-	-	MP.4	MP.4	-	-
Type of rasps	100 mm	125 mm	150 mm	200 mm	250 mm	300 mm
RAB.DRD: Half-round	-	-	-	-	MP.1	MP.0
RAB.P: Flat	-	-	-	-	MP.1	MP.0
RAB.RD: Round	-	-	-	-	MP.1	-



MP - Plastic handles for files and rasps



- Ergonomic handle in plastic resistant to workshop solvents.
- Supplied singly.

➤	d [mm]	L [mm]	[g]
MP.0	30	120	40
MP.1	30	120	45
MP.2	28	120	40
MP.3	28	105	35
MP.4	25	100	20

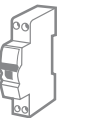
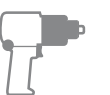
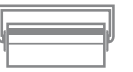

File sets

STG Set of 5 files



- Set of 5 files with varnished wood handles, for general engineering and automotive applications.
- Comprising:
 - PAM.B250A: Flat bastard file.
 - DRD.MD250A: Half-round second-cut file.
 - CAR.MD200EMA: Square second-cut file.
 - TRI.MD200EMA: Triangle second-cut file.
 - RD.MD200A: Round second-cut file.
- Supplied in grey hammer-finish wall-rack CKS.35A.
Weight: 1.265 kg.

STU Set of 9 files



- Set of 9 files and rasps for engineering and industrial maintenance.
- Comprising:
 - PAM.B250A: Flat bastard file.
 - PAM.MD200A: Flat second-cut file.
 - DRD.B250A: Half-round second cut bastard file.
 - DRD.MD200A: Half-round second-cut file.
 - RD.B250A: Round bastard file.
 - RD.MD200A: Round second-cut file.
 - CAR.MD200A: Square second-cut file.
 - TRI.MD150A: Triangle second-cut file.
 - RAB.DRDMD250A: Half-round second-cut rasp.
- Supplied in grey hammer-finish wall-rack CKS.34A.
Weight: 2.150 kg.

CLE.BAM100A Set of 6 locksmiths files - length 100 mm



NFE 75-001, NFE 75-002

- Geneva pattern with wooden handle.
- Available in 3 different cuts.
 - CLE.BAM100A: Bastard cut files.
 - CLE.MDAM100A: Second cut files.
 - CLE.DAM100A: Smooth cut files.
- In plastic wallet dimensions (L. x D. x H.):
200 x 105 x 11 mm.
Weight: 205 g.

MOD.LIM Module of 5 files 200 mm long with handle



- Comprising:
 - PAM.B200EMA: Flat bastard file.
 - DRD.MD200EMA: Half-round second-cut file.
 - CAR.MD200EMA: Square second-cut file.
 - TRI.MD200EMA: Triangle second-cut file.
 - RD.MD200EMA: Round second-cut file.
- Thermoformed module PL606.
- Finish: ergonomic handle in plastic resistant to workshop solvents.
Weight: 950 g.

■ LIM200EM.J5 Set of 5 second-cut files 200 mm long



NFE 75-001, NFE 75-002

- Comprising:
 - PAM.MD200EMA: Flat second-cut file.
 - DRD.MD200EMA: Half-round second-cut file.
 - CAR.MD200EMA: Square second-cut file.
 - RD.MD200EMA: Round second-cut file.
 - TRI.MD200EMA: Triangle second-cut file.
 - Finish: ergonomic handle in plastic resistant to workshop solvents.
- Weight: 820 g.

■ LIM250EM.J5 Set of 5 second-cut files 250 mm long



NFE 75-001, NFE 75-002

- Comprising:
 - PAM.MD250EMA: Flat second-cut file.
 - DRD.MD250EMA: Half-round second-cut file.
 - CAR.MD250EMA: Square second-cut file.
 - RD.MD250EMA: Round second-cut file.
 - TRI.MD250EMA: Triangle second-cut file.
 - Finish: ergonomic handle in plastic resistant to workshop solvents.
- Weight: 1.350 kg.

Engineers files

■ PAM.MDA - Half-round flat files



NFE 75-001, NFE 75-002

- Flat files with handle.
- 2 double cut squares.
- 1 single cut square.
- 1 smooth cut.
- Designed for steel, cast iron, brass, and hard plastics.

🔪	E x E1 [mm]	L [mm]	ΔΔ [g]
PAM.MD150A	4 x 15	150	75
PAM.MD200A	5 x 20	200	145
PAM.MD250A	6 x 25	250	270

■ PAM.MDEMA - Flat half-cut files with handle



NFE 75-001, NFE 75-002

- Flat files with handle.
- 2 double cut squares.
- 1 single cut square.
- 1 smooth cut.
- Finish: ergonomic handle in plastic resistant to workshop solvents.
- Designed for steel, cast iron, brass, and hard plastics.

🔪	E x E1 [mm]	L [mm]	ΔΔ [g]
PAM.MD150EMA	4 x 15	150	140
PAM.MD200EMA	5 x 20	200	200
PAM.MD250EMA	6 x 25	250	340

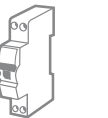
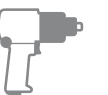
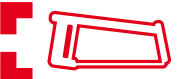

■ PAM.BA - Flat bastard files



NFE 75-001, NFE 75-002

- Flat files with handle.
- 2 double cut squares.
- 1 single cut square.
- 1 smooth cut.
- Designed for roughing steel, cast iron, brass, and hard plastics.

➤	E x E1 [mm]	L [mm]	ΔΔ [g]
PAM.B150A	4 x 15	150	60
PAM.B200A	5 x 20	200	145
PAM.B250A	6 x 25	250	270

■ PAM.BEMA - Flat bastard files with handle



NFE 75-001, NFE 75-002

- Flat files with handle.
- 2 double cut squares.
- 1 single cut square.
- 1 smooth cut.
- Finish: ergonomic handle in plastic resistant to workshop solvents.
- Designed for roughing steel, cast iron, brass, and hard plastics.

➤	E x E1 [mm]	L [mm]	ΔΔ [g]
PAM.B150EMA	4 x 15	150	140
PAM.B200EMA	5 x 20	200	200
PAM.B250EMA	6 x 25	250	340

■ DRD.MDA - Half-round second-cut files

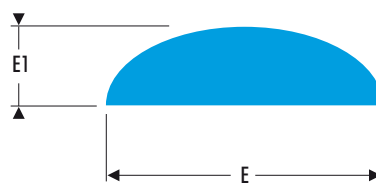

NFE 75-001, NFE 75-002

- Second-cut files with handle.
- Double second-cut squares.
- Double cut square.
- Designed for steel, cast iron, brass, and hard plastics.

➤	E x E1 [mm]	L [mm]	ΔΔ [g]
DRD.MD150A	4,5 x 16,0	150	60
DRD.MD200A	6 x 21	200	115
DRD.MD250A	7 x 25	250	220

■ DRD.MDEMA - Half-round second-cut files with handle

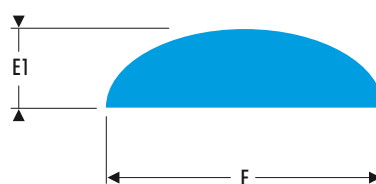

NFE 75-001, NFE 75-002

- Second-cut files with handle.
- Double second-cut squares.
- Double cut square.
- Finish: ergonomic handle in plastic resistant to workshop solvents.
- Designed for steel, cast iron, brass, and hard plastics.

➤	E x E1 [mm]	L [mm]	ΔΔ [g]
DRD.MD150EMA	4,5 x 16,0	150	100
DRD.MD200EMA	6 x 21	200	160
DRD.MD250EMA	7 x 25	250	280

DRD.BA - Half-round bastard files

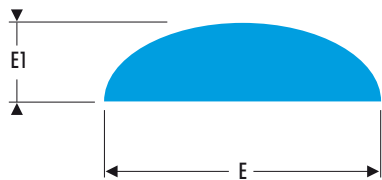

NFE 75-001, NFE 75-002

- Second-cut files with handle.
- Double second-cut squares.
- Double cut square.
- Designed for roughing steel, cast iron, brass, and hard plastics.

➤	E x E1 [mm]	L [mm]	ΔΔ [g]
DRD.B150A	4,5 x 16,0	150	60
DRD.B200A	6 x 21	200	115
DRD.B250A	7 x 25	250	220

DRD.BEMA - Half-round bastard files with handle

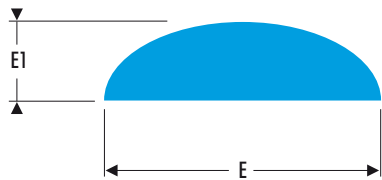

NFE 75-001, NFE 75-002

- Second-cut files with handle.
- Double second-cut squares.
- Double cut square.
- Ergonomic handle in plastic resistant to workshop solvents.
- Designed for roughing steel, cast iron, brass, and hard plastics.

➤	E x E1 [mm]	L [mm]	ΔΔ [g]
DRD.B150EMA	4,5 x 16,0	150	100
DRD.B200EMA	6 x 21	200	160
DRD.B250EMA	7 x 25	250	280

RD.MDA - Second-cut round files

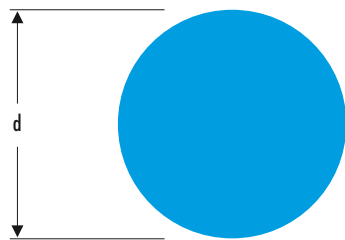

NFE 75-001, NFE 75-002

- Round files with handle.
- Double square.
- Designed for steel, cast iron, brass, and hard plastics.

➤	d [mm]	L [mm]	ΔΔ [g]
RD.MD150A	6	150	50
RD.MD200A	8	200	75
RD.MD250A	10	250	135

RD.MDEMA - Second-cut round files with handle

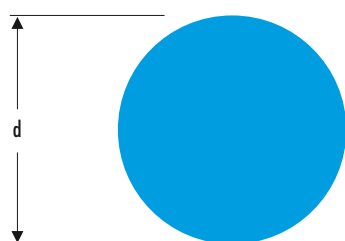

NFE 75-001, NFE 75-002

- Round files with handle.
- Double square.
- Finish: ergonomic handle in plastic resistant to workshop solvents.
- Designed for steel, cast iron, brass, and hard plastics.

➤	d [mm]	L [mm]	ΔΔ [g]
RD.MD150EMA	6	150	100
RD.MD200EMA	8	200	140
RD.MD250EMA	10	250	208

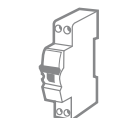

RD.BA - Round bastard files

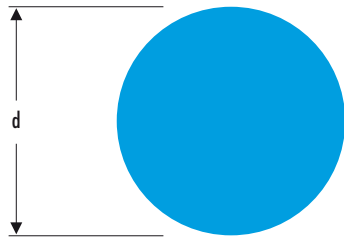

NFE 75-001, NFE 75-002

- Round files with handle.
- Double square.
- Designed for roughing steel, cast iron, brass, and hard plastics.

	d [mm]	L [mm]	$\Delta\Delta$ [g]
RD.B150A	6	150	50
RD.B200A	8	200	75
RD.B250A	10	250	135

RD.BEMA - Round bastard files with handle

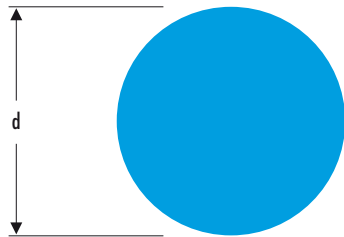

NFE 75-001, NFE 75-002

- Round files with handle.
- Double square.
- Finish: ergonomic handle in plastic resistant to workshop solvents.
- Designed for roughing steel, cast iron, brass, and hard plastics.

	d [mm]	L [mm]	$\Delta\Delta$ [g]
RD.B150EMA	6	150	100
RD.B200EMA	8	200	140
RD.B250EMA	10	250	200

CAR.MDA - Second-cut square files

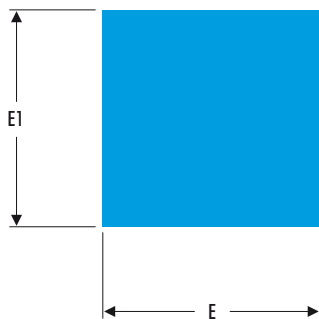

NFE 75-001, NFE 75-002

- Square files with handle.
- Double square on 4 cuts.
- Designed for steel, cast iron, brass, and hard plastics.

	E x E1 [mm]	L [mm]	$\Delta\Delta$ [g]
CAR.MD150A	6 x 6	150	60
CAR.MD200A	8 x 8	200	80
CAR.MD250A	10 x 10	250	140

CAR.MDEMA - Second-cut square files with handle

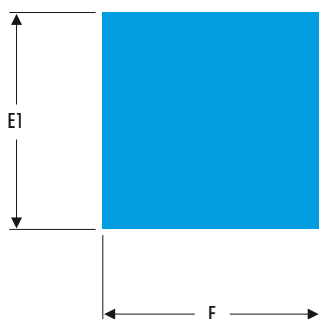

NFE 75-001, NFE 75-002

- Square files with handle.
- Double square on 4 cuts.
- Finish: ergonomic handle in plastic resistant to workshop solvents.
- Designed for steel, cast iron, brass, and hard plastics.

	E x E1 [mm]	L [mm]	$\Delta\Delta$ [g]
CAR.MD150EMA	6 x 6	150	100
CAR.MD200EMA	8 x 8	200	120
CAR.MD250EMA	10 x 10	250	190

■ CAR.BEMA - Square bastard files with handle

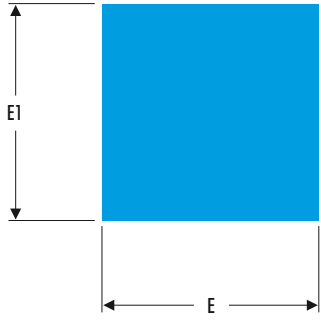

NFE 75-001, NFE 75-002

- Square files with handle.
- Double square on 4 cuts.
- Finish: ergonomic handle in plastic resistant to workshop solvents.
- Designed for roughing steel, cast iron, brass, and hard plastics.

⇒	E x E1 [mm]	L [mm]	ΔΔ [g]
CAR.B150EMA	6 x 6	150	100
CAR.B200EMA	8 x 8	200	120
CAR.B250EMA	10 x 10	250	190

■ TRI.MDA - Second-cut triangle files

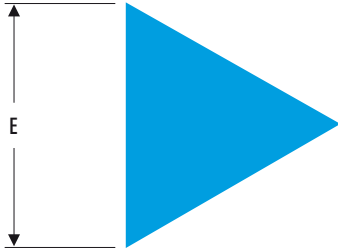

NFE 75-001, NFE 75-002

- Triangle files with handle.
- Double square on 3 cuts.
- Designed for steel, cast iron, brass, and hard plastics.

⇒	E [mm]	L [mm]	ΔΔ [g]
TRI.MD150A	11	150	90
TRI.MD200A	15	200	170
TRI.MD250A	19	250	270

■ TRI.MDEMA - Second-cut triangle files with handle

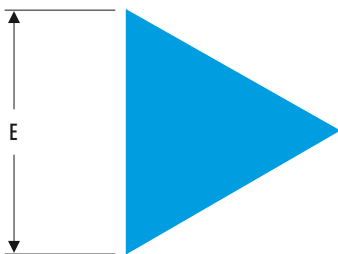

NFE 75-001, NFE 75-002

- Triangle files with handle.
- Double square on 3 cuts.
- Finish: ergonomic handle in plastic resistant to workshop solvents.
- Designed for steel, cast iron, brass, and hard plastics.

⇒	E [mm]	L [mm]	ΔΔ [g]
TRI.MD150EMA	11	150	130
TRI.MD200EMA	15	200	210
TRI.MD250EMA	19	250	330

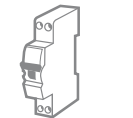
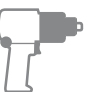
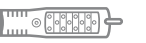

TRI.BEMA - Triangle bastard files with handle

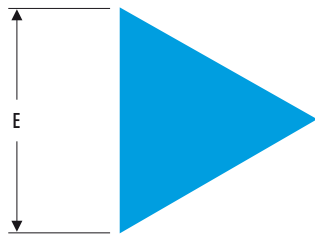

NFE 75-001, NFE 75-002

- Triangle files with handle.
- Double square on 3 cuts.
- Ergonomic handle in plastic resistant to workshop solvents.
- Designed for roughing steel, cast iron, brass, and hard plastics.

➤	E [mm]	L [mm]	ΔΔ [g]
TRI.B150EMA	11	150	130
TRI.B200EMA	15	200	210
TRI.B250EMA	19	250	330

Wood rasps

RAB.DRDMDA - Half-round second-cut rasps medium cut

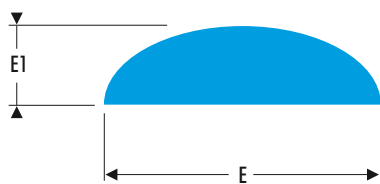
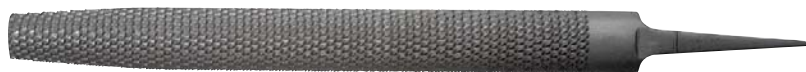

NFE 75-001, NFE 75-002

- Second-cut rasps with handle.
- RAB.DRDB250EMA - RAB.DRDMD300EMA: Rasp with handle.
- Finish: ergonomic handle in plastic resistant to workshop solvents.
- Designed for soft materials, aluminium, lead, plastic or wood.

➤	E x E1 [mm]	L [mm]	ΔΔ [g]
RAB.DRDMD250A	25 x 7	250	260
RAB.DRDMD300A	30,0 x 8,5	300	420
RAB.DRDMD250EMA	25 x 7	250	300
RAB.DRDMD300EMA	30,0 x 8,5	300	380

RAB.DRDBA - Half-round bastard rasps large cut

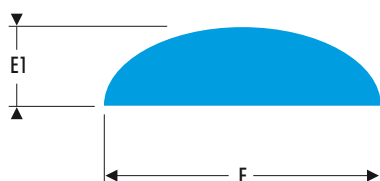
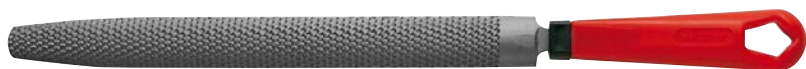

NFE 75-001, NFE 75-002

- Second-cut rasps with handle.
- RAB.DRDB300EMA: Rasp with handle.
- Finish: ergonomic handle in plastic resistant to workshop solvents.
- Designed for roughing work, soft materials, aluminium, lead, plastic or wood.

➤	E x E1 [mm]	L [mm]	ΔΔ [g]
RAB.DRDB250A	25 x 7	250	260
RAB.DRDB300EMA	30,0 x 8,5	300	480

RAB.RDA - Round second-cut rasps medium cut

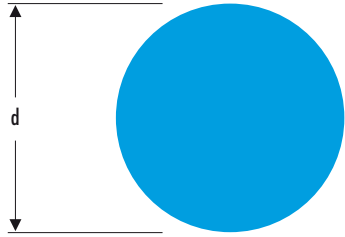
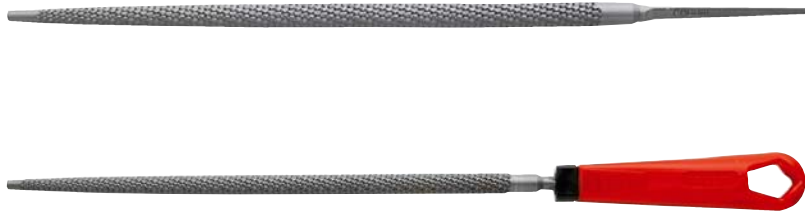

RAB.P - Flat rasps medium cut



NFE 75-001, NFE 75-002

- Round rasps with handle.
- RAB.RD250EMA: Rasp with handle.
- Finish: ergonomic handle in plastic resistant to workshop solvents.
- Designed for soft materials, aluminium, lead, plastic or wood.

➤	d [mm]	L [mm]	ΔΔ [g]
RAB.RD250A	10	250	140
RAB.RD250EMA	10	250	180

NFE 75-001, NFE 75-002

- Flat rasps with handle.
- Bastard finish: recommended for roughing work.
- Second cut finish recommended for current work.
- Designed for current work, for soft materials, aluminium, lead, plastic or wood.

➤	E x E1 [mm]	L [mm]	Files	ΔΔ [g]
RAB.PB250A	25 x 6	250	Bastard	320
RAB.PMD250A	25 x 6	250	Second cut finish	320

Precision files

AS - Selections of 6 and 12 needle files



- AS.6L: Selection of 6 needle files: round (RD), half-round (DRD), flat entry (DPE), square (CAR), triangular (TRI), tile (PAM).
- AS.12L: Selection of 12 needle files: round (RD), half-round (DRD), flat entry (PDE), crossing file (FS), knife (CT), square (CAR), triangular (TRI), file (PAM), strip (BAR), BR tile (PAMBR), hook (CRO), oval (OV).
- T0 for rough filing.
- T2 for precise filing.

➤	L [mm]	Files	Contents	Content set	ΔΔ [g]
AS.6L140T0A	140	T0	Plastic wallet	6	115
AS.6L140T2A	140	T2	Plastic wallet	6	115
AS.6L160T0A	160	T0	Plastic wallet	6	140
AS.6L160T2A	160	T2	Plastic wallet	6	140
AS.12LBC100T0A	100	T0	Cardboard box	12	55
AS.12LBC100T2A	100	T2	Cardboard box	12	55
AS.12LBP140T0A	140	T0	Plastic box	12	115
AS.12LBP140T2A	140	T2	Plastic box	12	115
AS.12LBP160T0A	160	T0	Plastic box	12	140
AS.12LBP160T2A	160	T2	Plastic box	12	140
AS.12LTP180T0A	180	T0	Plastic wallet	12	175
AS.12LTP180T2A	180	T2	Plastic wallet	12	175

Taps

TAP SELECTION GUIDE

- Ground-thread backed-off taps.
- ISO metric RH thread.6H machining.
- Set of 2 (ref. T2) for soft metals: 1 taper tap, 1 bottoming tap.
- Set of 3 (ref. T3) for hard metals: 1 taper tap, 1 second tap, 1 bottoming tap.

Max. hardness: 70 daN/mm²:
 - for taps 227 and 80 daN/mm²
 - for taps 227.S.

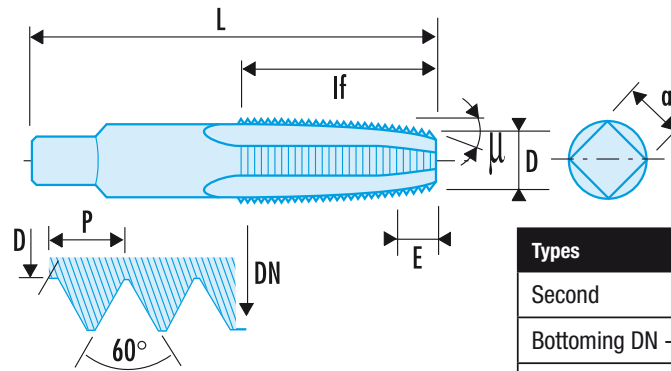

Types	D	E
Second	= 6 P	6°
Bottoming DN - 1.2p.	= 3.5 P	9°
Bottoming 18°	= 2 P	18°

227 - Standard taps

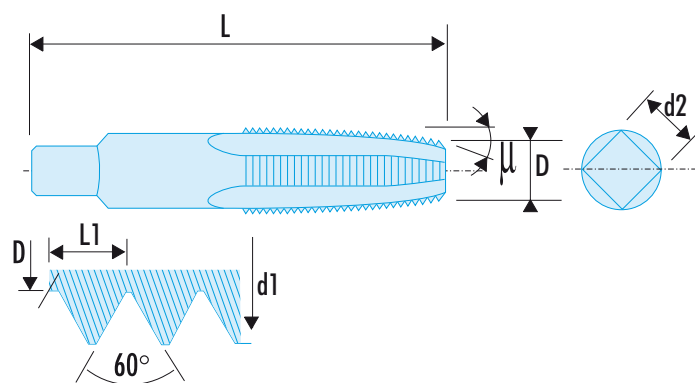

NF ISO 529, NFEN 22857, ISO 529, ISO 2857

- HSS steel.
- 227.T3: Set of 3 taps (taper, second and bottoming).
- 227.T2: Set of 2 taps (taper and bottoming).

Ref	d1 [mm]	d2 [mm]	L [mm]	L1 [mm]	Content set	ΔΔ [g]
227.3X50T3	3	2,50	48	0,50	x 3	20
227.4X70T3	4	3,15	53	0,70	x 3	25
227.5X80T3	5	4,00	58	0,80	x 3	40
227.6X100T3	6	5,00	66	1,00	x 3	50
227.7X100T3	7	5,60	66	1,00	x 3	60
227.8X125T3	8	6,30	72	1,25	x 3	85
227.9X125T3	9	7,10	72	1,25	x 3	100
227.10X150T3	10	8,00	80	1,50	x 3	140
227.12X175T3	12	7,10	89	1,75	x 3	150
227.14X200T3	14	9,00	95	2,00	x 3	240
227.16X200T3	16	10,00	102	2,00	x 3	305
227.18X250T3	18	11,20	112	2,50	x 3	460
227.20X250T3	20	11,20	112	2,50	x 3	490
227.3X50T2	3	2,50	48	0,50	x 2	10
227.4X70T2	4	3,15	53	0,70	x 2	10
227.5X80T2	5	4,00	58	0,80	x 2	15
227.6X100T2	6	5,00	66	1,00	x 2	25
227.7X100T2	7	5,60	66	1,00	x 2	45
227.8X125T2	8	6,30	72	1,25	x 2	60
227.10X150T2	10	8,00	80	1,50	x 2	70
227.12X175T2	12	7,10	89	1,75	x 2	80

227.S - «High performance» cobalt taps



NF ISO 529, NFEN 22857, ISO 529, ISO 2857

- Molybdenum and cobalt steel.
- The hardness of cobalt increases torque resistance and wear compared with standard taps.
- 227.ST3: Set of 3 taps (taper, second and bottoming).
- 227.ST2: Set of 2 taps (taper and bottoming).

Ø	d1 [mm]	d2 [mm]	L [mm]	L1 [mm]	Content set	ΔΔ [g]
227.S3X50T3	3	2,50	48	0,50	x 3	15
227.S4X70T3	4	3,15	53	0,70	x 3	25
227.S5X80T3	5	4,00	58	0,80	x 3	40
227.S6X100T3	6	5,00	66	1,00	x 3	50
227.S8X125T3	8	6,30	72	1,25	x 3	85
227.S10X150T3	10	7,10	80	1,50	x 3	140
227.S12X175T3	12	8,00	89	1,75	x 3	150
227.S3X50T2	3	2,50	48	0,50	x 2	5
227.S4X70T2	4	3,15	53	0,70	x 2	10
227.S5X80T2	5	4,00	58	0,80	x 2	15
227.S6X100T2	6	5,00	66	1,00	x 2	25
227.S7X100T2	7	5,60	66	1,00	x 2	45
227.S8X125T2	8	6,30	72	1,25	x 2	50
227.S9X125T2	9	7,10	72	1,25	x 2	50
227.S10X150T2	10	8,00	80	1,50	x 2	70
227.S12X175T2	12	7,10	89	1,75	x 2	80
227.S14X200T2	14	9,00	95	2,00	x 2	160
227.S16X200T2	16	10,00	102	2,00	x 2	200
227.S18X250T2	18	11,20	112	2,50	x 2	290

Dies

221 - Split dies



NF ISO 261, ISO 261, DIN ISO 261

- ISO metric RH thread.
- Chrome-vanadium HSS hardened to 62/64 HRc (234 daN/mm²).
- Tapered adjusting screw.

Ø	d [mm]	d1 [mm]	d2 [mm]	E [mm]	E1 [mm]	ΔΔ [g]
221.3X50	25,4	3	0,50	8	3,5	25
221.4X70	25,4	4	0,70	8	3,5	25
221.5X80	25,4	5	0,80	8	3,5	30
221.6X100	25,4	6	1,00	9	3,5	30
221.7X100	25,4	7	1,00	9	3,5	30
221.8X125	25,4	8	1,25	9	3,5	30
221.9X125	25,4	9	1,25	9	3,5	30
221.10X150	38,1	10	1,50	13	6,0	80
221.12X175	38,1	12	1,75	13	6,0	90
221.14X200	38,1	14	2,00	13	6,0	80
221.16X200	38,1	16	2,00	13	6,0	75
221.18X250	38,1	18	2,50	15	8,0	75

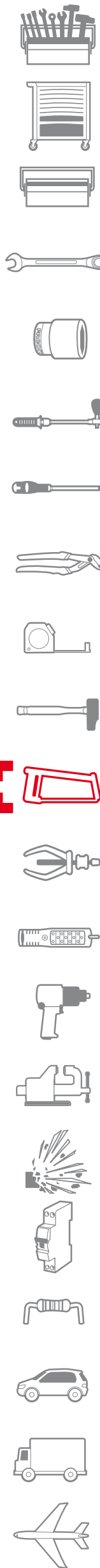

Threading and tapping tool sets

221 - Tap and die sets



- Each selection includes sets of two taps per dimension: taper and bottoming.
- Selections Ref 227.SJ1 and 227.SJ2 include cobalt taps (Ref 227.S).
- Tray PL.47 and box BT.109G: for selection Ref 224.227J1 and 221.227SJ1.
- Tray PL.46 and box BT.105: for selection Ref 224.227J2 and 221.227SJ2.

Ref	d [mm]	Dimension [mm]	Content set	ΔΔ [kg]
221.227J1	M3 - M4 - M5 - M6 - M7 - M8 - M9 - M10 - M12	470 x 195 x 53	18 taps - 9 threads - 4 dies	3,100
221.227SJ1	M3 - M4 - M5 - M6 - M7 - M8 - M9 - M10 - M12	470 x 195 x 53	18 taps - 9 threads - 4 dies	3,100
221.227J2	M3 - M4 - M5 - M6 - M7 - M8 - M9 - M10 - M12 - M14 - M16 - M18	540 x 284 x 58	24 taps - 12 threads - 5 dies	5,700
221.227SJ2	M3 - M4 - M5 - M6 - M7 - M8 - M9 - M10 - M12 - M14 - M16 - M18	540 x 284 x 58	24 taps - 12 threads - 5 dies	5,700

227.A - Tap and drill-bit sets



- Each selection includes sets of 3 taps per dimension: taper, second and bottoming.
- Selection Ref 227.SJ2A includes cobalt taps (Ref 227.S).
- Supplied in metal box BT.228J2.

Ref	d [mm]	Drill Bits	Dimension [mm]	Content set	ΔΔ [kg]
227.J2A	M3 - M4 - M5 - M6 - M8 - M10 - M12	2,5 - 3,3 - 4,2 - 5,0 - 6,8 - 8,5 - 10,2 mm	172 x 105 x 57	21 taps - 7 drill bits	1,100
227.SJ2A	M3 - M4 - M5 - M6 - M8 - M10 - M12	2,5 - 3,3 - 4,2 - 5,0 - 6,8 - 8,5 - 10,2 mm	172 x 105 x 57	21 cobalt taps - 7 drill bits	1,100

227 - Tap set



- Each selection includes sets of 3 taps per dimension: taper, second and bottoming.
- Selection Ref 227.SJ1 includes cobalt taps (Ref 227.S).
- Supplied in metal box BT.228J1.

Ref	d [mm]	Dimension [mm]	Content set	ΔΔ [g]
227.J1	M3 - M4 - M5 - M6 - M8 - M10 - M12	118 x 118 x 31	21 taps	720
227.SJ1	M3 - M4 - M5 - M6 - M8 - M10 - M12	118 x 118 x 31	21 cobalt taps	720

Thread restoring tools

237 - Thread restoring tool



- To restore male and female screw threads.

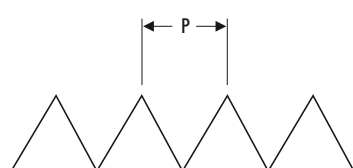

Ref	L [mm]	P [mm]	ΔΔ [g]
237.A	230	75 - 100 - 125 - 150 - 175 - 200 - 250 - 300	120
237.B	230	80 - 100 - 125 - 150 - 175 - 200 - 250 - 300	125
237.C	230	10F - 11F - 12F - 14F - 16F - 18F - 20F - 24F	125

Tools for taps and dies

830A.L - Long ratcheting tap wrenches



- Ideal for cutting threads in tight recesses.
- Two-way ratchet.
- Ratchet lock.
- Finish: polished chromed.

➤	d [mm]	L [mm]	Open Position 0 maxi [mm]	For Tapp	ΔΔ [g]
830A.5L	20,5	250	5	M6	230
830A.10L	25,5	300	8	M12	415

830A - Short ratcheting tap wrenches



- Two-way ratchet.
- Ratchet lock.
- Finish: polished chromed.

➤	d [mm]	L [mm]	Open Position 0 maxi [mm]	ΔΔ [g]
830A.5	20,5	85	5	165
830A.10	25,5	105	8	312

830A.RN - Repair kits



- Comprising chuck and spring.
- 830A.5RN, for 830A.5 and 830A.5L.
- 830A.10RN, for 830A.10 and 830A.10L.
- Weight: 15 g.

831 - Adjustable tap wrenches



NF E 66-130

- Pressure-cast Zamak body. Machined and hardened clamp.
- Finish: grey hammered finish.

➤	L [mm]	Open Position 0 maxi [mm]	ΔΔ [g]
831.1	180	2-8	100
831.2	300	4-11	300
831.3	385	5-16	705

832 - Die stocks



- Pressure-cast Zamak body for accurate centring of the die.
- Finish: grey hammered finish.

➤	d [mm]	d ["]	L [mm]	Organiser for	ΔΔ [g]
832.1'	25,4	1	220	221.3x50 --> 221.9x125	115
832.1'1/2	38,1	1"-1/2	325	221.10x150 --> 221.18x250	410

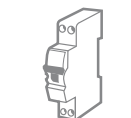

Workshop drill bits

222A.T - Ground twist drills



- For steel up to 800 MPA, stainless steel, grey cast-iron and aluminium alloy.

➤	d [mm]	L [mm]	ΔΔ [g]
222A.T1	1,0	35	5
222A.T1,5	1,5	40	5
222A.T2	2,0	50	5
222A.T2,5	2,5	57	5
222A.T3	3,0	62	5
222A.T3,3	3,3	65	5
222A.T3,5	3,5	70	5
222A.T4	4,0	75	10
222A.T4,2	4,2	75	10
222A.T4,5	4,5	80	10
222A.T5	5,0	85	10
222A.T5,5	5,5	92	15
222A.T6	6,0	92	15
222A.T6,5	6,5	102	20
222A.T6,8	6,8	105	25
222A.T7	7,0	107	25
222A.T7,5	7,5	110	30
222A.T8	8,0	117	35
222A.T8,5	8,5	117	40
222A.T9	9,0	127	50
222A.T9,5	9,5	127	55
222A.T10	10,0	132	60
222A.T10,2	10,2	132	65
222A.T10,5	10,5	132	70
222A.T11	11,0	142	80
222A.T11,5	11,5	142	90
222A.T12	12,0	152	100
222A.T12,5	12,5	152	110
222A.T13	13,0	152	115

222A.TJ - Sets of ground twist drills



NF ISO 235, ISO 235, DIN 338

- For steel up to 800 MPA, stainless steel, grey cast-iron and aluminium alloy.
- Sets 222A.TJ19 and 222A.TJ25: Bits with 5/10 mm increments.
- Sets 222A.TJ50 and 222A.TJ81: Bits with 1/10 mm increments.

➤	d maxi [mm]	Dimension [mm]	Content set	ΔΔ [kg]
222A.TJ19	1 - 10	165 x 110 x 35	19	0,730
222A.TJ25	1 - 13	190 x 110 x 54	25	1,390
222A.TJ50	1 - 5,9	135 x 120 x 35	50	0,760
222A.TJ81	2 - 10	235 x 210 x 145	81	3,700

222A.TJ32 Set of 32 ground twist drills



NF ISO 235, ISO 235, DIN 338

- For steel up to 800 MPA, stainless steel, grey cast-iron and aluminium alloy.
- 20 drill bits Ref 222A.T, diam.: 1 --> 10.5 mm (in 5/10 increments).
- 12 drill bits for riveting and tapping dimension diam.: 1.9 - 2.1 - 2.6 - 2.9 - 3.2 - 3.3 - 3.8 - 4.2 - 5.1 - 6.8 - 7.9 - 10.2 mm.
- Dimensions (L. x W. x H.): 170 x 110 x 50 mm.
- Weight: 1.170 kg.



229A - Boring bits

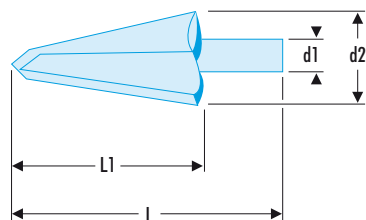

- For drilling, deburring, boring thin materials: press sheet, non ferrous metals.
- HSS steel.
- Max. thickness recommended: 4 mm.
- Does not require a tapping hole.



Ref	d1 [mm]	d2 [mm]	L [mm]	L1 [mm]	ΔΔ [g]
229A.1	6	3 - 14	59	37	25
229A.2	8	5 - 20	71	41	45
229A.3	9	16,0 - 30,5	76	48	130

229A.J3 Set of 3 tapered bits



- Capacity: 3 to 30.5 mm.
- Supplied with a bottle of lubricant.
- Supplied in a pressed sheet box, dim. (L. x W. x H.): 120 x 100 x 38 mm.
- Weight: 555 g.



Stepped bits

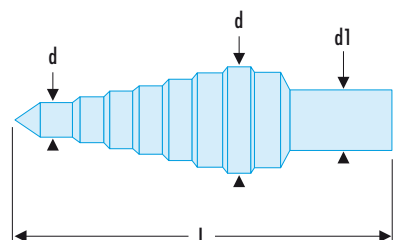

- For precision-drilling straight bores in all materials.
- No pilot hole required.
- Cross-sharpening: self-centering.
- More aggressive cut for easier drilling and no burs.
- Better shaving removal.
- Less vibration, quieter operation.
- Parallel shank with 3 flats for positive rotation.
- Laser-engraved diameter marking in a groove.
- 678006: Special ISO gland.
- 678014: PG size step drill.

Ref	d mini - maxi [mm]	d1 [mm]	L [mm]	ΔΔ [g]
229A.ST0	4 - 5 - 6 - 7 - 8 - 9 - 10 - 11 - 12	6	65	25
229A.ST1	4 - 6 - 8 - 10 - 12 - 14 - 16 - 18 - 20	8	75	65
229A.ST2	4 - 6 - 9 - 12 - 15 - 18 - 21 - 24 - 27 - 30 - 33 - 36 - 39	10	107	315
229A.ST3	6 - 9 - 13 - 16 - 19 - 21 - 23 - 26 - 29 - 32 - 35 - 38	10	100	320
678006	6,5 - 8,5 - 10,5 - 12,5 - 16,5 - 20,5 - 25,5 - 29,0 - 32,5 - 36,5 - 40,5	10	96	310
678014	6,0 - 9,0 - 12,5 - 15,2 - 18,6 - 20,4 - 22,5 - 26,0 - 28,3 - 30,5 - 34,0 - 37,0	10	100	300

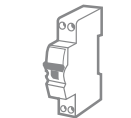

Bits for impact machinery

223.SJ7 Set of 7 short drill bits for straight chucks



- Sharpened carbide tip inserts.
 - Ground from stock with L-groove.
 - Diameters: 4 - 5 - 6 - 7 - 8 - 10 - 12 mm.
 - In a steel case, dim. (L. x W. x H.): 155 x 100 x 30 mm.
- Weight: 355 g.

Variable pitch holesaws

BIMETAL HSS HOLESAW

FOR CUTTING HOLES THROUGH STANDARD MATERIALS AND METALS USED IN MECHANICAL ENGINEERING, SHEET-METALWORKING AND PLUMBING.

- High-speed steel teeth, hardness > 63 HRc.
- Holesaw back in thick sheet steel to minimise vibration.
- Side slots and holes for chip removal.



Quick assembly : chuck, pilot drill, spring, blade.

609A - Variable pitch holesaws



- Variable pitch holesaws 4 to 6 mm.
- Softer cut and reduced vibration.
- Cutting depth 34 mm.
- Chuck and drill for holesaws 19 to 29 mm 609A.M1.
- Chuck and drill for holesaws 35 to 68 mm 609A.M2.
- Set of 2 spare bits + chuck screws: 609.M-ACC.

FACOM	d [mm]	L [mm]	ΔΔ [g]
609A.19	19	51	30
609A.22	22	51	45
609A.25	25	51	65
609A.29	29	51	80
609A.35	35	51	100
609A.38	38	51	110
609A.40	40	45	140
609A.44	44	45	145
609A.51	51	45	150
609A.57	57	45	165
609A.64	64	45	185
609A.65	65	45	200
609A.67	67	45	230
609A.68	68	45	285

Holesaw sets

609A.J - Set of variable-pitch holesaws with chucks



- Comprising:
 - 609A.M1: 1 chuck and drill for holesaws 19 to 29 mm.
 - 609A.M2: 1 chuck for holesaws 35 to 64 mm.
 - 609A.M-ACC: Set of 2 spare bits + chuck screws.
- Supplied in a plastic case, dim. (L. x W. x H.): 245 x 185 x 75 mm.

	d [mm]	ΔΔ [kg]
609A.J1	22 - 29 - 35 - 44 - 51 - 64	1,800
609A.J3	19 - 22 - 29 - 35 - 38 - 44 - 51 - 57 - 64	2,100



793898 Case set of 5 variable-pitch holesaws with «electrician» chuck



- Special electricians set: recess boxes.
- Comprising:
 - 5 holesaws, diam.: 38 - 40 - 65 - 67 - 68 mm.
 - 609A.M2: 1 chuck for holesaws 35 to 68 mm.
 - 609A.M2: Set of 2 spare bits + chuck screws.
 - Tray PL.643.
- Supplied in metal case, dim.(L. x D. x H.): 245 x 185 x 75 mm.
Weight: 1.680 kg.

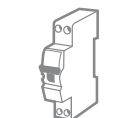

Mills

VFA Cutters

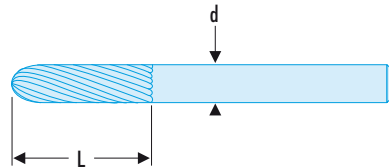

- Tungsten carbide.
- Right-hand spiral.
- Cutter shank diameter 6 mm.

➤	No.	d [mm]	L [mm]	tr/min	ΔΔ [g]
VFA.600	1	6	18	50000	25
VFA.602	2	6	18	50000	25
VFA.604	3	6	18	50000	25
VFA.606	4	6	18	50000	20
VFA.608	5	6	18	50000	20
VFA.610	6	6	15	50000	20
VFA.1200	1	12	25	20000	55
VFA.1202	2	12	25	20000	55
VFA.1204	3	12	25	20000	50
VFA.1206	4	12	25	20000	30
VFA.1208	5	12	25	20000	35
VFA.1210	6	12	20	20000	40

229.TT - 90° cone bits

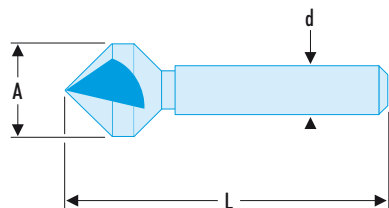

- 3 HSS cutting edges for countersunk screw holes.
- Requires a pilot hole with a cylindrical bit ref 222A.T.

➤	A [mm]	d [mm]	L [mm]	ΔΔ [g]
229.TT2	10,4	6	50	10
229.TT3	16,5	10	60	30
229.TT4	20,5	10	63	50
229.TT5	25,0	10	67	70

229.TTJ4 90° cone bits



- Comprising:
 - 4 bits: 229.TT2 --> 229.TT5 (and lubricant).
 - In a steel case, dim. (L x W x H.): 120 x 100 x 38 mm.
 - Weight: 450 g.

Scrapers

231 Three-square scraper



- Finish: high quality steel blade, polished chrome finish and varnished wood handle.
- Shank length: 200 mm.
- Weight: 180 g.

▣ 232 Half-round curved scraper



- Finish: high quality steel blade, polished chrome finish and varnished wood handle.
- Shank length: 200 mm.
- Weight: 180 g.

▣ 329 Flat scraper



- Finish: high quality steel blade, polished chrome finish and varnished wood handle.
- Shank length: 200 mm.
- Weight: 185 g.

▣ 235.J1 Set of 3 stainless steel scrapers



- Stainless steel blade, thickness: 0.8 mm.
- Reinforced striking zone.
- 3 shapes:
 - Straight, width: 32 mm.
 - Straight, width: 50 mm.
 - Angled, width: 32 mm.
- Length: 215 mm.
- Weight: 430 g.

▣ 237.J1 Set of 3 flexible spatulas



- Stainless steel blade, thickness: 0.5 mm.
- 3 shapes:
 - Straight, width: 32 mm.
 - Straight, width: 50 mm.
 - Angled, width: 32 mm.
- Width: 32 - 50 - 75 mm.
- Length: 215 mm.
- Weight: 275 g.

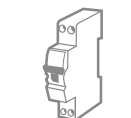

883 - Scroll shears

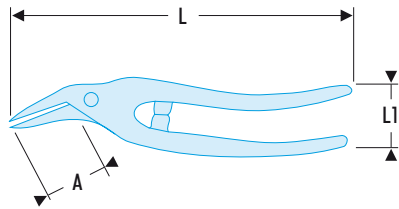

- Specially-shaped nose for accurately following detailed patterns.
- Steel end stops.
- Left-cut scroll shears: 883B.G.
- Right-cut scroll shears: 883B.
- Right cut large-capacity scroll shears: 883.32.
- Finish: Epoxy paint.

883	A [mm]	L [mm]	L1 [mm]	Capacity Stainless [80 kg/mm ²]	Capacity Semi-hard steel [mm]	ΔΔ [g]
883B.G	46	260	43 - 170	0,8	1,0	535
883B	50	260	43 - 170	0,8	1,0	530
883.32	73	320	47 - 170	0,9	1,2	765

884 Panel shears

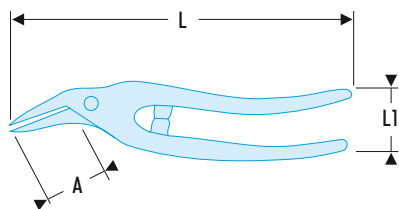

- The bottom-blade clearance makes these shears ideal for continuous straight cuts in large panels, leaving clean edges.
- Steel end stop.
- Right-hand panel shears: 884B.
- Right-hand high capacity panel shears: 884.30.
- Finish: Epoxy paint.

884	A [mm]	L [mm]	L1 [mm]	Capacity Stainless [80 kg/mm ²]	Capacity Semi-hard steel [mm]	ΔΔ [g]
884B	40	260	43 - 130	0,8	1,0	670
884.30	52	300	45 - 150	0,9	1,2	840

General-purpose shears

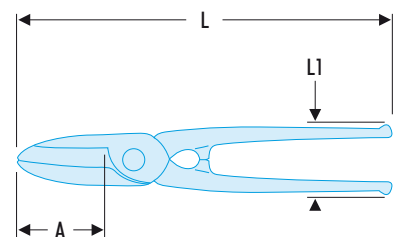

- 2 wide blades.
- Capacity:
 - Stainless 80 kg/mm²: 0.5 mm.
 - Semi-hard steel: 0.8 mm.
- Forged steel end stop.
- Finish: Epoxy paint.

880	A [mm]	L [mm]	L1 [mm]	ΔΔ [g]
880	55	260	45 --> 130	520

882A-884A Two-hand shears

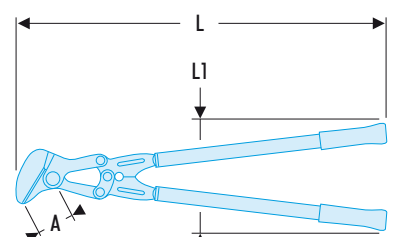

- Very high demultiplication.
- Forged steel end stop.
- Cutting capacity for blued sheet 120 kg/mm²: 2.0 mm (882A.65) and 2.5 mm (884A.65).
- Finish: Zinc-coated blades, tubular handles with neoprene grips.
- Spare blades:
 - 882A.L65 for 882A.65.
 - 884A.L65 for 884A.65.

882A	A [mm]	L [mm]	L1 [mm]	ΔΔ [kg]
882A.65	50	665	210 --> 820	2,130
884A.65	48	660	200 --> 790	2,400

Right-cut universal scroll shears

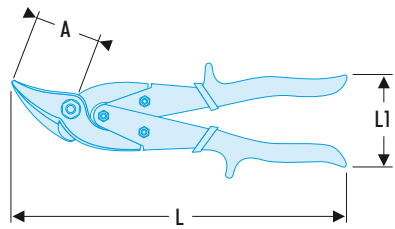

ASME B107.500

- Demultiplication reducing efforts.
- Forged, hardened and burnished blades.
- Red sheathed grips with guard.
- Inset opening spring.
- Lock-closed catch.
- Cutting capacity.
- Stainless 80 kg/mm²: 0.8 mm.
- Semi-hard steel: 0.8 mm.

Ref	A [mm]	L [mm]	L1 [mm]	ΔΔ [g]
882A	32	250	45 - 130	475

982 - Compound scroll shears

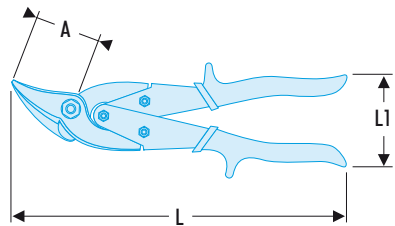

ASME B107.500

- Panel-type shears with slightly serrated cutting edges to prevent workpiece slip.
- Good demultiplication and inset opening spring.
- Forged chrome molybdenum blades.
- Ergonomic non-slip bi-material grips.
- Colour-coded according to direction of cut.
- Red: left cut (Ref 982.G).
- Green: right cut (Ref 982).
- Jaw lock catch.
- Cutting capacity.
- Stainless 80 kg/mm²: 0.8 mm.
- Semi-hard steel: 1.2 mm.

Ref	A [mm]	L [mm]	L1 [mm]	ΔΔ [g]
982	45	245	65 - 190	380
982.G	45	245	65 - 190	380

985 - «Aircraft» shears

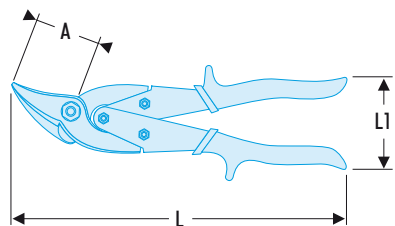

ASME B107.500

- High demultiplication allows long runs without effort.
- Good demultiplication and inset opening spring.
- Slightly serrated cutting edges prevent workpiece slip.
- Forged chrome molybdenum blades.
- Ergonomic non-slip bi-material grips.
- Colour-coded according to direction of cut.
- Red: left cut (Ref 985.LE).
- Green: right cut (Ref 985.RI).
- Yellow: straight cut (Ref 985.ST).
- Jaw lock catch.
- Cutting capacity:
- Stainless 80 kg/mm²: 0.8 mm.
- Semi-hard steel: 1.2 mm.

Ref	A [mm]	L [mm]	L1 [mm]	ΔΔ [g]
985.LE	55	255	60 - 150	400
985.RI	55	255	60 - 150	400
985.ST	55	255	65 - 165	390

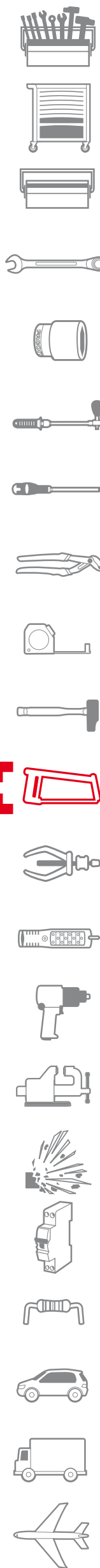

Nibblers

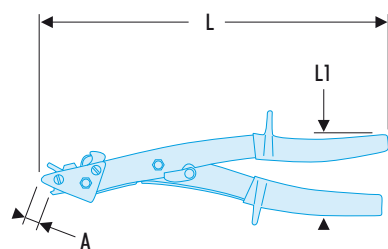

- Inset opening spring and high demultiplication allow effortless cutting along intricate patterns, removing a strip 2.8 mm wide.
- Die and blade system severs the strip at end of run.
- Top blades cut wire up to 2 mm in semi-hard steel and 2.5 mm in mild steel.
- Lock-closed catch.
- Cutting capacity.
 - Stainless 80 kg/mm²: 0,8 mm.
 - Semi-hard steel: 1 mm.
- Spare blade: 887A.L1.

	A [mm]	L [mm]	L1 [mm]	ΔΔ [g]
887A	7	260	45 - 110	520

990.B BOLT CROPPERS

Powerful

- Increased steel-cutting capacity up to 160 kg/mm².
- Available with forged arms.

Durable

- Harder blades for a more durable cut.
- Body specially treated to reduce play to a minimum.
- High performance chrome blades.
- Eccentric screw adjustment of play between blades.

Efficient

- Minimum cutting effort.
- Handgrip with guard for greater comfort

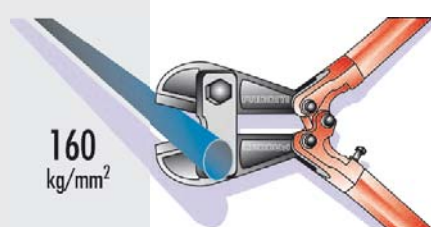

990.BF - Axial cut bolt croppers

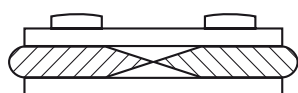

- Forged arms = less cutting flexion.
- High performance chrome blades.
- Harder blades for a more durable cut.
- Eccentric screw adjustment of play between blades.
- Hand grip with guard for greater comfort.

	L ["]	L [mm]	Ø [mm]: 60 - 140 - 160 kg/mm ²	Blade	ΔΔ [kg]
990.BF0	18	450	7,0 - 6,0 - 5,5	990.LB0	1,700
990.BF1	24	600	10 - 8 - 7	990.LB1	2,800
990.BF2	30	750	13 - 9 - 8	990.LB2	4,200
990.BF3	35	900	16 - 10 - 9	990.LB3	6,400
990.BF4	41	1050	18 - 11 - 10	990.LB4	8,600

990.BF - Axial cut tubular arm bolt croppers

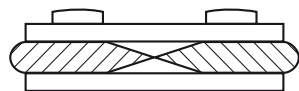

- High performance chrome steel blades.
- Harder blades for a more durable cut.
- Eccentric screw adjustment of play between blades.
- Hand grip with guard for greater comfort.

➤	L ["]	L [mm]	Ø [mm]: 60 - 140 - 160 kg/mm ²	Blade	ΔΔ [kg]
990.B0	18	450	7,0 - 6,0 - 5,5	990.LB0	1,700
990.B1	24	600	10 - 8 - 7	990.LB1	2,800
990.B2	30	750	13 - 9 - 8	990.LB2	4,200
990.B3	35	900	16 - 10 - 9	990.LB3	6,400
990.B4	41	1050	18 - 11 - 10	990.LB4	8,600

990.RB0 - Flush-cut bolt croppers

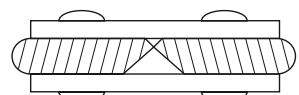

- Specific blades for high performance chrome steel flush cutting.
- Harder blades for a more durable cut.
- Eccentric screw adjustment of play between blades.
- Hand grip with guard for greater comfort.
- 990.BRF0: Forged arms.
- 990.R00 - 990.R0: Tubular arms.

➤	L ["]	L [mm]	Ø [mm]: 60 - 140 - 160 kg/mm ²	Blade	ΔΔ [kg]
990.RB00	12	350	6 - 5 - 5	990.LRB00	1,000
990.RB0	18	450	7,0 - 6,0 - 5,5	990.LRB0	1,700
990.BRF0	18	450	7,0 - 6,0 - 5,5	990.LRB0	1,700

990.LB Replacement blades for series 990.B (with screws)



- Bolt-cropper blades are consumables and subject to normal wear. Facom guarantees their conformity to dimensional standards and suitability for recommended applications.
- Actual service life is dependent on conditions of use.
- Supplied with fasteners.

➤	For	ΔΔ [kg]
990.LB0	990.BF0 - 990.B0	0,650
990.LB1	990.BF1 - 990.B1	1,050
990.LB2	990.BF2 - 990.B2	1,650
990.LB3	990.BF3 - 990.B3	2,400
990.LB4	990.BF4 - 990.B4	3,400
990.LRB00	990.RB00	0,450
990.LRB0	990.BRF0 - 990.RB0	0,650

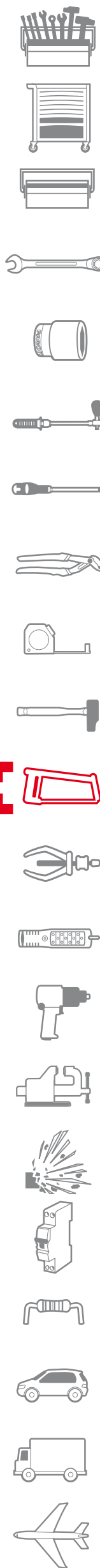

Mini croppers

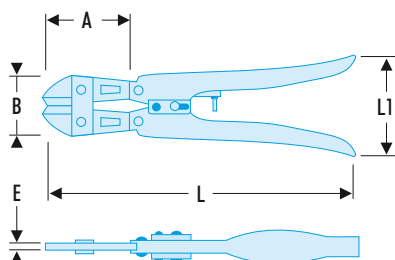
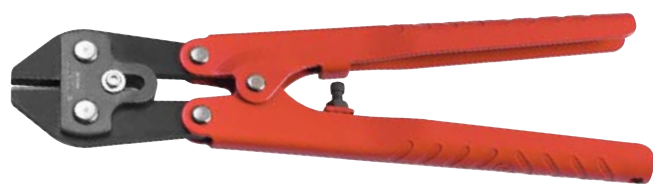

- Compact, lightweight tool with demultiplication system designed to cut hard and semi-hard wire: piano wire, bolts, rivets, pins and nails, etc.
- Forged, hardened blades.
- Cutting capacity:
 - Piano wire: max. diameter 2 mm to 200 kg/mm².
 - Soft wire: max. diameter 4 mm to 60 kg/mm².
- Ergonomic hardened pressed-steel handles with adjustable, shock-absorbing end stop.
- Spring-assisted opening.
- Blades lock in closed position.
- Finish: bronzed blades, painted grips.

➤	A [mm]	B [mm]	E [mm]	L [mm]	L1 [mm]	ΔΔ [g]
997A.20	54,5	40	4,5	210	57	275

Copper and aluminium cable cutters

412 - Cable cutters

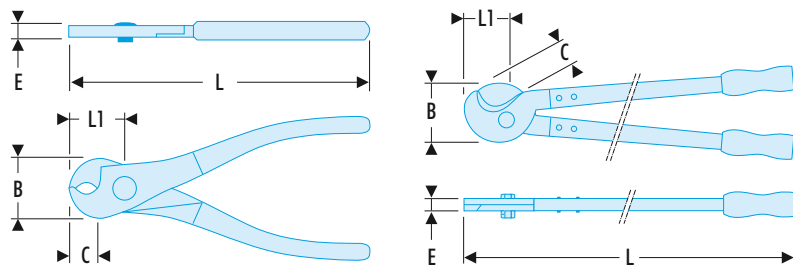

- 412B.10 "Compact" cable cutters:
 - Capacity: diameter 10 mm.
 - Integral opening spring.
 - Lock closed catch.
 - Cross proof design.
- 412.16 "Standard" cable cutters:
 - Capacity: diameter 16 mm.
 - Heavy-duty head, cross proof design.
 - Safety stop.
- 412.30 - 412.42 "Heavy-duty" cable cutters:
 - Capacity: 32 mm (Ref. 412.30) and 42 mm (Ref. 412.42).
 - Powerful action, cuts without crushing electric cables..
 - Safety stop.
 - Set of blades for 412.30: 412.L30.
 - Set of blades for 412.42: 412.L42.

➤	B [mm]	C [mm]	d mini - maxi [mm]	d [mm]	E [mm]	L [mm]	L1 [mm]	ΔΔ [kg]
412B.10	28	21	53 - 190	10	10	170	40	0,225
412.16	54	28	80 - 370	16	14	290	45	0,670
412.30	70	40	155 - 1000	32	16	600	60	2,460
412.42	115	70	200 - 1300	42	16	800	90	3,695

Ratchet cable cutters

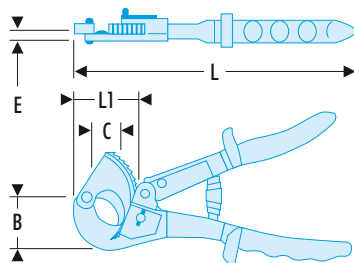
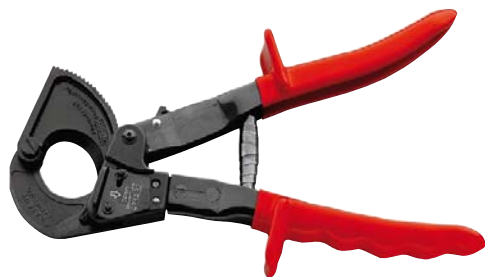

- Ratchet-blade system for easy cut through thick gauge cables.
- Particularly useful in confined spaces.
- Non-slip grips with guards.
- Capacities: 32 - 52 mm.
- Spare blade for 413A.32: 413A.L32.

➤	B [mm]	C [mm]	d maxi [mm]	E [mm]	L [mm]	L1 [mm]	ΔΔ [g]
413A.32	58	34	32	7,8	255	65	385
413.52	80	53	52	8,0	275	75	800

985912 Manual 10 mm dia. copper/aluminium cable cutters



- Notched end for stripping wires.
- For single and multi-strand cables.
- Capacity:
 - Multi-strand cable: diameter 10 mm.
 - Single strand copper: diameter 8 mm.
 - Almelec: diameter 6 mm.
- Length: 165 mm.
- Weight: 225 g.

985925 Manual 18 mm dia. copper/aluminium cable cutters



- Notched end for stripping wires.
- For single and multi-strand cables.
- Capacity:
 - Multi-strand cable: diameter 18 mm.
 - Single strand copper: diameter 15 mm.
 - Almelec: diameter 10 mm.
- Length: 231 mm.
- Weight: 350 g.

Steel cable cutters

«Compact» steel cable cutters

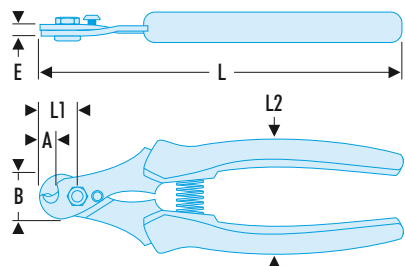

- Lightweight tool with blades and cutting angle designed for cutting solid materials and multi-strand cables.
- Push catch to lock closed, simply squeeze handles to release.
- Blades hardened to 60-62 HRc.
- Capacity:
 - 5 mm for 60 - 100 kg/mm² soft steel cable.
 - 4 mm for 130 - 160 kg/mm² hard steel cable.
 - 3 mm for 60 kg/mm² round cable.

985912	A [mm]	B [mm]	E [mm]	L [mm]	L1 [mm]	L2 [mm]	ΔΔ [g]
996.5	7	21	8	165	12	50 - 125	165

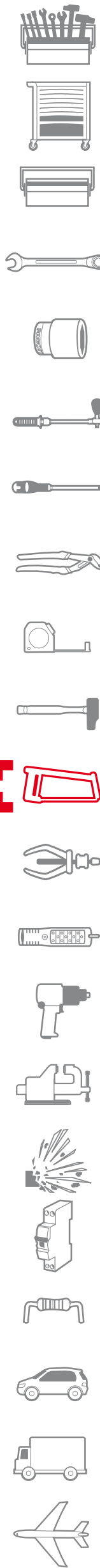

«Standard» steel cable cutters

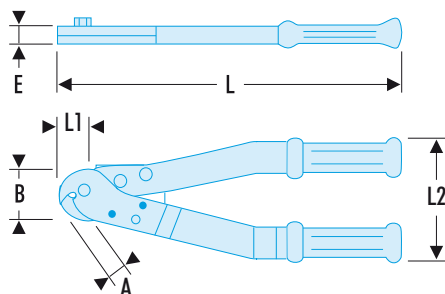

- Blade inserts in high-performance steel.
- Compact and powerful with ergonomic grips.
- Capacity:
 - 8 mm for 60 - 100 kg/mm² soft steel cable.
 - 7 mm for 130 - 160 kg/mm² hard steel cable.
 - 6 mm for 60 kg/mm² round cable.
- Spare blades: 996.L8.

	A [mm]	B [mm]	E [mm]	L [mm]	L1 [mm]	L2 [mm]	ΔΔ [g]
996.8	12	42	16	340	21	115 - 470	890

Steel cable cutters



- Compact and powerful model.
- Blade inserts in high-performance steel.
- Cross proof design.
- Capacity:
 - 12 mm for 60 - 100 kg/mm² soft steel cable.
 - 10 mm for 120 - 150 kg/mm² hard steel cable.
 - 8 mm for 60 - 80 kg/mm² round cable.
- Spare blades: 996.L12.

	A [mm]	B [mm]	E [mm]	L [mm]	L1 [mm]	ΔΔ [kg]
996A.12	20	73	16	600	50	2,730

«Power» steel cable cutters

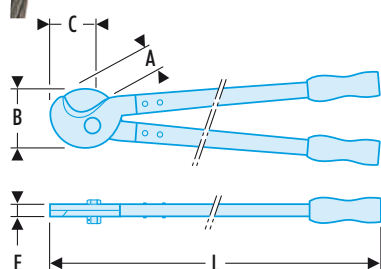

- Maximum power model.
- Forged blades in high-performance steel.
- Cross proof design.
- Ergonomic handles.
- Capacity:
 - 16 mm for 60 - 100 kg/mm² soft steel cable.
 - 13 mm for 120 - 150 kg/mm² hard steel cable.
 - 10 mm for 60 - 80 kg/mm² round cable.
- Spare blades: 996.L16.

	A [mm]	B [mm]	E [mm]	L [mm]	L1 [mm]	ΔΔ [kg]
996.16	28	115	16	800	55	4,950

THE NEW UTILITY KNIFE RANGE

CUTTING TOOLS DESIGNED FOR PROFESSIONALS

Uncompromising safety for professional applications.

- Recommended by the Health and Safety Committees (CHSCT).
- Avoids the risk of cuts as a result of handling the blade, or blade slippage.



- Automatic reload model.
- Blade lock feature.



Productivity and efficiency.

- In-handle blade storage allows easy blade changes.
- Time-saving and safe.

Especially designed for intensive and daily use.

- Stainless steel blade guide providing perfect torsion resistance.
- Ergonomic handle for a more comfortable grip.
- Soft finish to avoid slippage.

Rigorous quality.

- Dynamic endurance tested for mechanism lifetime.
- Load tested for blade-locking.
- Torsion tested to ensure blade retention.
- Tested for resistance to workshop chemicals.

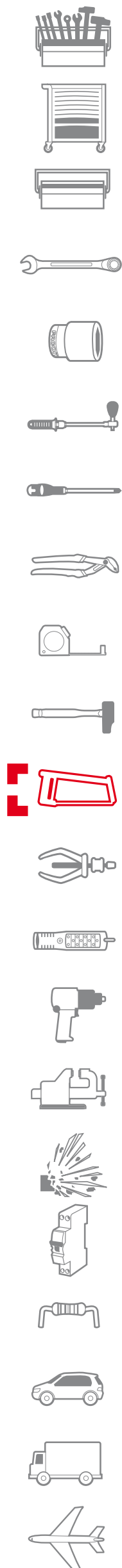

Safety knife with retractable blade

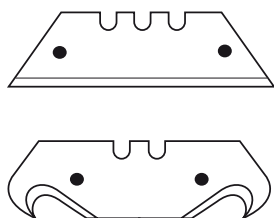

- Safety knife.
- Blade automatically retracts after use.
- Zamak body.
- ABS cursor, front or side thumb control.
- Supplied with 3 blades (1 factory-mounted and 2 in the body).

844.D	E maxi [mm]	H mini - maxi [mm]	L [mm]	ΔΔ [g]
844.D	27	40,5 - 44,0	176	185

844.R Retractable utility knife with interchangeable blades

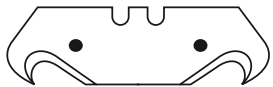
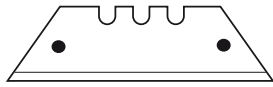

- Choice of 3 blade settings.
 - Moulded handle housing 5 blades.
 - Zamak body.
 - Zinc alloy slide-button.
- Weight: 190 g.

18 mm automatically reloading utility knife



- Productivity, accessibility, safety.
- Automatically reloading snap-off blades.
- Ergonomic soft ABS handle.
- Stainless steel blade guide.
- Blade lock knob.
- 6-blade cartridge.
- Integral blade snapper.

➤	E maxi [mm]	H [mm]	L [mm]	ΔΔ [g]
844.S18	24	47	172	160

Cutter with 18 mm snap-off blades



- Cutter with snap-off blades.
- Ergonomic soft ABS handle.
- Stainless steel blade guide.
- Automatic blade lock.
- 2-blade cartridge.
- Integral blade snapper.

➤	E [mm]	H [mm]	L [mm]	ΔΔ [g]
844.SE18	24	43	172	90

Cutter with 9 mm snap-off blades



- Cutter with snap-off blades.
- Ergonomic soft ABS handle.
- Stainless steel blade guide.
- Automatic blade lock.
- 2-blade cartridge.
- Integral blade snapper.

➤	E [mm]	H [mm]	L [mm]	ΔΔ [g]
844.S9	17	30	149	47

BLADE SELECTION GUIDE

Our cutting tool experience at the service of professionals

A perfectly cut blade guarantees your safety.

- A neat, clean cut.
- Does not damage the material to be cut.
- Effortless cutting without the risk of blade slippage or pull-out.
- Saves time.



A choice of packaging

- 10 blade dispenser always handy.



Choosing the right blade.

- What material is being cut ? Material, thickness.
- On what backing surface will cutting be performed ? (Does it need protecting ?)
- Is there a risk of slipping ? (uneven surface)
- What is the work environment ?
- What is the frequency of use ? What is the desired durability ?

A blade is a compromise between :

- **Hardness** : For a strong cutting section and good stress resistance.
- **Flexibility** : For stress resistance as well as allowing the blade to twist without deforming for a neat cut.
- **Cutting angle** : to guarantee an optimum cut according to the material.

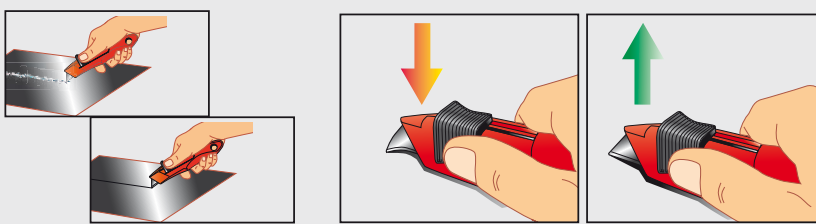

High strength perforated trapezoidal blade

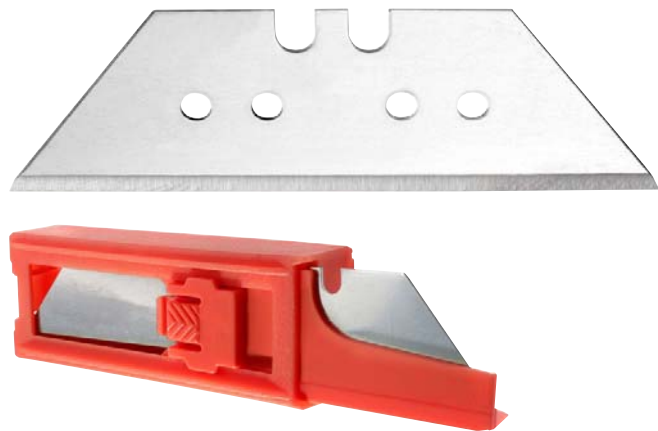

- High strength trapezoidal blade.
- Designed to produce a perfect cut in intensive applications.
- Ideal for cutting:
 - Thick cardboard.
 - Hose.
 - Plastic.
 - Resilient foam.
 - Heat-shrinkable tubing.
 - Nylon strip.
 - Plastic tubes.
 - Seals.
- Supplied in a 10 blade dispenser.

	E [mm]	H [mm]	L [mm]	ΔΔ [g]
844.TTL10	0,65	19	60	50

High performance safety trapezoidal blade

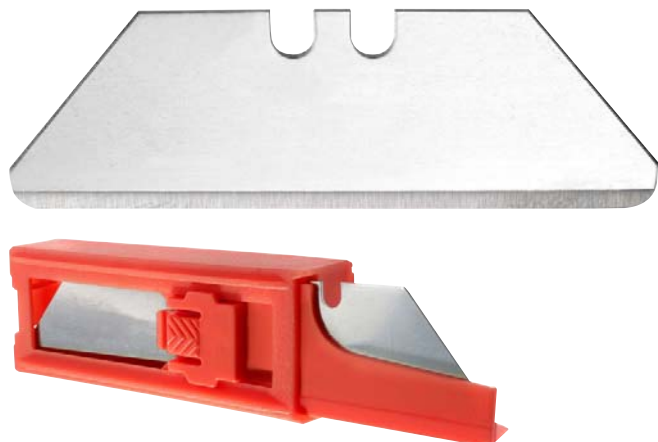

- High performance trapezoidal blade.
- Rounded corner to avoid risk of accidental cutting.
- Designed to produce a perfect cut in intensive applications.
- Ideal for cutting:
 - Thick cardboard.
 - Hoses.
 - Plastic.
 - Resilient foam.
 - Heat-shrinkable tubing.
 - Nylon strip.
 - Plastic tubes.
 - Seals.
- Supplied in a 10 blade dispenser.

	E [mm]	H [mm]	L [mm]	ΔΔ [g]
844.TRL10	0,65	19	60	50

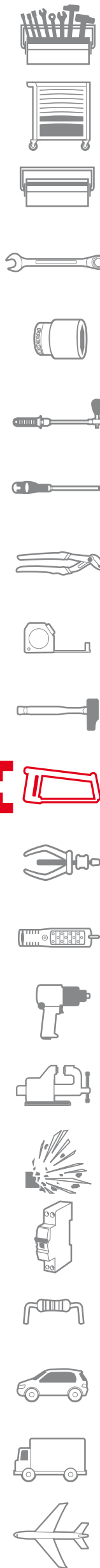

High strength hook blade

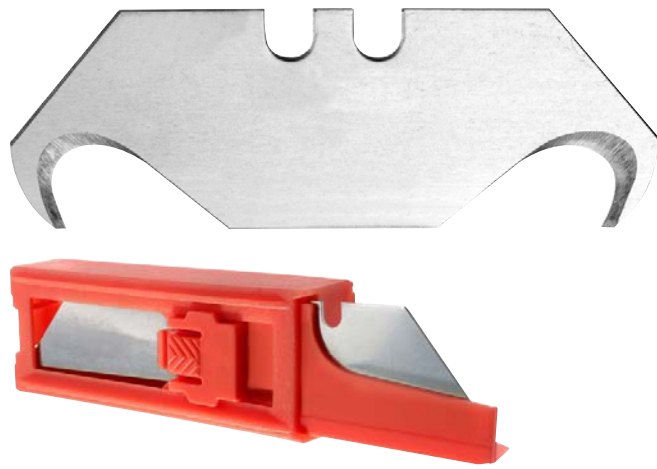

- High strength hook blade.
- Specially designed to protect the backing during cutting.
- Ideal for cutting:
 - Floor finishes, e.g. carpet, lino, PVC or other laid material.
 - Straps and thick fabric.
- Supplied in a 10 blade dispenser.

	E [mm]	H [mm]	L [mm]	ΔΔ [g]
844.TCL10	0,65	19	50	50

18 mm snap-off blades



- 7-segment 18 mm snap-off blade:
- Ideal for all everyday cutting applications.
 - Thick cardboard.
 - Hose.
 - Plastic.
 - Resilient foam.
 - Heat-shrinkable tubing.
 - Nylon strip.
 - Plastic tubes.
 - Seals.
- Warning, snap-off blades are not designed to withstand excessive torsion forces.
- Supplied in a 10 blade dispenser.

	E [mm]	H [mm]	L [mm]	ΔΔ [g]
844.S18L10	0,53	18	110	90

9 mm snap-off blades



- 7-segment 18 mm snap-off blade:
- Ideal for all everyday cutting applications.
 - Thick cardboard.
 - Hose.
 - Plastic.
 - Resilient foam.
 - Heat-shrinkable tubing.
 - Nylon strip.
 - Plastic tubes.
 - Seals.
- Warning, snap-off blades are not designed to withstand excessive torsion forces.
- Supplied in a 10 blade dispenser.

	E [mm]	H [mm]	L [mm]	ΔΔ [g]
844.S9L10	0,43	9,5	84	30

"CUT ALL" GENERAL-PURPOSE SHEARS

AN EFFORTLESS CLEAN CUT EVERY TIME

Aluminium sheet (up to 1 mm thick), hard metal sheet (up to 0.5 mm), PVC, cardboard, rubber, floor coverings up to 5 mm thick. Hoses, plastic ties, small diameter pipes, electric cables (up to d 2.5 mm), insulating foam, wrapping paper... and many other applications.

- 1-Precise
serrated blades, no risk of slipping.
- 2-Smart
2 opening positions, adapts to your hand. (26 mm / 36 mm).
- 3-Safe
Locks in closed position.
- 4-Comfortable
Non-slip bi-material grips.

980 - Straight serrated shears

980C - Angled serrated shears

- Ideal for cutting long lengths.
- Keeps the hand away from the cutting operation.



Multi purpose shears



980



980C

- 980: straight blade version.
- 980C: angled blade version.
- Blade opening 29 to 36 mm.
- Handle opening 77 to 102 mm.
- Comfortable: non-slip bi-material grips.
- Safe: locks in closed position.
- Accurate: slightly serrated blade prevents any risk of slippage.
- Ideal for all everyday cutting applications:
 - Cardboard, rubber, PVC, leather 5 mm thick.
 - Thin sheet steel 0.5 mm thick, aluminium sheet up to 1 mm thick.
 - Electric cables up to 2.5 mm diameter.
 - Hoses, tubes, insulating foam, etc.

Model	B [mm]	C [mm]	L [mm]	ΔΔ [g]
980	67	49	205	200
980C	67	49	205	200

Sheathed electricians scissors



- Ergonomic plastic moulded sheathing, left/right hand.
- Long blades, with wire cutter.
- Finish: bi-material grips, burnished blades.

Model	L [mm]	Blade	ΔΔ [g]
841A.4	143	45 mm	80

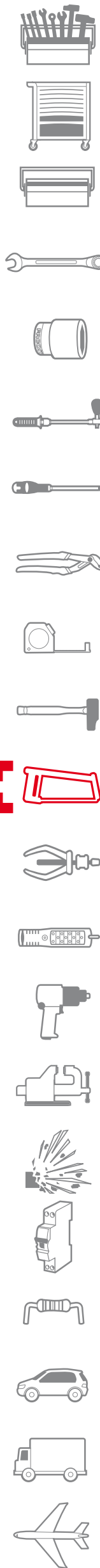

Scissors - knives

Electricians scissors



- 100% metal handles, left/right hand.
- Short reinforced blades, with wire cutter.
- Finish: polished chromed.

➤	L [mm]	Blade	ΔΔ [g]
841	150	33	95

Heavy-duty scissors



- Industrial model, very strong and high capacity.
- Ideal to cut leather, rubber, carpet, fabric, etc.
- 100% metal right-handed handles.
- Finish: polished chromed.

➤	L [mm]	Blade	ΔΔ [g]
841.7	255	115 mm	490

Multi-purpose scissors



- Multiple use, highly versatile and maximum comfort.
- Exclusive FACOM ergonomic grip for right-handers for better comfort.
- Ideal for cutting thick cardboard, aluminium (thickness 0.2 mm), rubber (thickness 3mm), leather (thickness: 5 mm), rope, etc.
- Stainless steel blades: precision and better durability of the cutting edge.
- Finish: bi-material grips, burnished blades.

➤	L [mm]	Blade	ΔΔ [g]
841A.9	255	107 mm	210

840 THE 100% STAINLESS STEEL KNIFE

THE KNIFE DESIGNED AS A TOOL

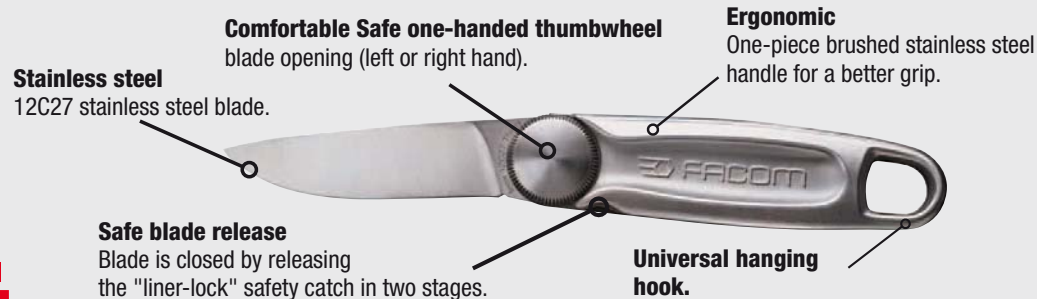

Comes with horizontal leather case for complete freedom of movement and compliance with the safety regulations.

840LE Thumbwheel knife



- 12C27 stainless steel construction: very high corrosion resistance. Ideal in marine environments.
 - Quick one-handed opening.
 - Right/left hand.
 - Safe: Liner lock safety catch and 2 stage release.
 - Universal hanging hook.
 - Blade length 73.5 mm; closed length: 115.5 mm.
 - Total length: 189 mm.
 - Comes with horizontal leather case.
- Weight: 250 g.

840.4A Lock-back knife



- Polished stainless blade.
- Safe: lock-back.
- Rosewood handle and nickel silver bolster.
- Blade length 78 mm; closed length: 105 mm.
- Total length: 183 mm.
- Weight: 160 g.

840.F Lock-back knife with bi-material handle



- Blade in polished stainless steel. Blade partially smooth for accurate cutting and another serrated for powerful cutting.
- Quick one-handed opening.
- Knife at the tip of the knife: window breaker function.
- Safe: lock-back.
- Universal hanging hook.
- Clip at the back of the knife for direct hanging to the belt.
- Blade length 77 mm; closed length: 115 mm.
- Total length: 186 mm.
- Supplied in vertical nylon case which fastens to the belt.
- Weight: 170 g.

640180 Twin-blade electricians knife with plastic handle



- Electricians knife with blades suitable for cable work:
 - 1 straight hollow ground general-purpose blade (length: 65 mm).
 - 1 short curved blade, specially designed for cable work (length: 35 mm).
- Safe: lock-back for each blade.
- Length closed: 104 mm.
- Total length: 131/169 mm.
- Weight: 100g.

840B Electricians knife with wire stripper



- Blade in polished stainless steel.
- Billhook blade.
- Wood handle.
- Blade length 60 mm; closed length: 100 mm.
- Total length: 160 mm.
- Weight: 85 g.

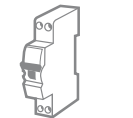
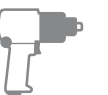

843 Twin-blade electricians knife with wood handle



- Blades in polished stainless steel.
- Billhook blade, length 65 mm.
- Straight blade, length: 80 mm.
- Wood handle.
- Length closed: 100 mm.
- Total length: 165/180 mm.
- Weight: 115 g.

840.1 Electricians knife with wire stripper with wood handle



- Blade in polished stainless steel.
- Blade with 2 notches:
 - 1 half-moon notch for stripping.
 - 1 vee for cutting.
- Rosewood handle.
- Blade length 77 mm; closed length: 103 mm.
- Total length: 180 mm.
- Weight: 75 g.

PUNCH KIT

THE SOLUTION TO EASILY PRODUCE ALL YOUR GASKETS

These kits are used to cut out clean and accurate circular gaskets in a variety of materials including cardboard, leather, rubber and fabric.

To cut holes \varnothing 3 to 50 mm, use a punch 245A.T with a shank 245A. M.

To cut holes \varnothing 44 to 420 mm, use calipers with centre-point and cutter.

All components are available either separately or in kits.

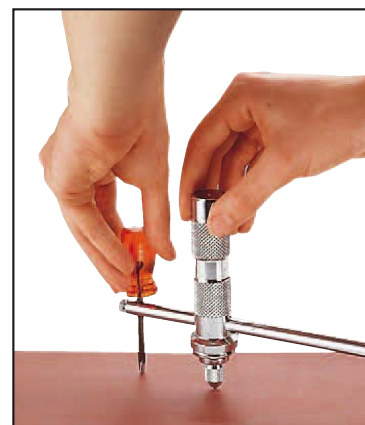

245.J1 «Standard» kit



- For making round gaskets.
- Cutting capacity:
 - Punch diameter: 3 to 30 mm.
 - Compass diameter: 56 to 330 mm.
- Supplied in a plastic case BP.115 with tray PL.100A.
- Dimensions (L. x W. x H.): 332 x 143 x 67 mm.
- Weight: 1.800 kg.

245.J2 «Maintenance» kit



- For making round gaskets.
- Cutting capacity:
 - Punch diameter: 3 to 50 mm.
 - Compass diameter: 44 to 420 mm.
- Supplied in a plastic case BP.109 with tray PL.99A.
- Dimensions (L. x W. x H.): 478 x 234 x 72 mm.
- Weight: 3.700 kg.

245A.C Scriber



- For making round gaskets.
- Cutting capacity: diam. 44 to 420 mm.
- Supplied in plastic case, dim.(L. x W. x H.): 260 x 90 x 40 mm.
- Weight: 590 g.

245A.T - Punches



Ref	Capacity Cubic Ø maxi [mm]	d [mm]	For	ΔΔ [g]
245A.T3	M13 x 100	3	245.J1 - 245.J2	10
245A.T4	M13 x 100	4	245.J1 - 245.J2	10
245A.T6	M13 x 100	6	245.J1 - 245.J2	15
245A.T8	M13 x 100	8	245.J1 - 245.J2	15
245A.T10	M13 x 100	10	245.J1 - 245.J2	15
245A.T12	21	12	245.J1 - 245.J2	20
245A.T14	28	14	245.J1 - 245.J2	20
245A.T16	21	16	245.J1 - 245.J2	20
245A.T18	21	18	245.J1 - 245.J2	25
245A.T20	21	20	245.J1 - 245.J2	25
245A.T22	31	22	245.J1 - 245.J2	40
245A.T24	31	24	245.J1 - 245.J2	40
245A.T26	31	26	245.J1 - 245.J2	45
245A.T28	31	28	245.J1 - 245.J2	50
245A.T30	31	30	245.J1 - 245.J2	60
245A.T32	41	32	245.J2	75
245A.T34	41	34	245.J2	80
245A.T36	41	36	245.J2	80
245A.T38	41	38	245.J2	75
245A.T40	41	40	245.J2	75
245A.T42	52	42	245.J2	100
245A.T44	52	44	245.J2	105
245A.T46	52	46	245.J2	105
245A.T48	52	48	245.J2	100
245A.T50	52	50	245.J2	100

Accessories for punches and calipers



Ref	No.	For	ΔΔ [g]
245A.M1	1	245.J1	450
245A.M2	2	245.J1	530
245A.M3	3	245.J1	310
245A.M4	4	245.J1 - 245.J2	150
245A.P1	5	245.J1 - 245.J2 - 245.AC	40
245A.C1	6	245.J1 - 245.J2 - 245.AC	40
245A.B1	7	245.J1	130
245A.B2	8	245.J1 - 245.J2	160

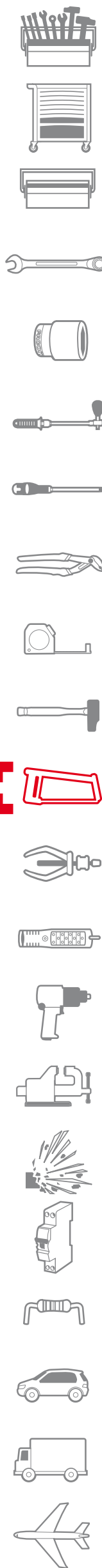

志發

CHEE FATT

W : www.cheefatt.com

E : marketing@cheefatt.com

T : +65 6294 2066