



## "FOD" FLUORESCENT TOOLS

**1021**



- PROTWIST® FLUO screwdrivers ..... 1022
- PROTWIST® FLUO handle keys..... 1023
- FLUO sleeve set of angled keys..... 1024
- FLUO pliers..... 1025

## SPECIFIC AEROSPACE TOOLS

**1029**



- Ring wrenches..... 1029
- Spline profile tools..... 1029
- Crowfoot bits..... 1031
- Tools for aerospace fasteners ..... 1032
- 1/2" metal handle ratchets ..... 1033
- 3/8" metal handle ratchets ..... 1033
- 1/4" metal handle ratchets ..... 1033

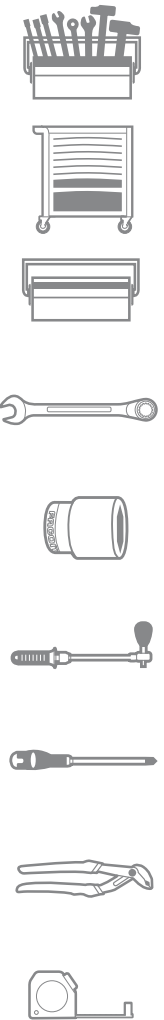

## AERONAUTIC TOOLKITS

**1038**

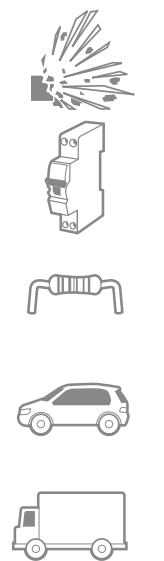
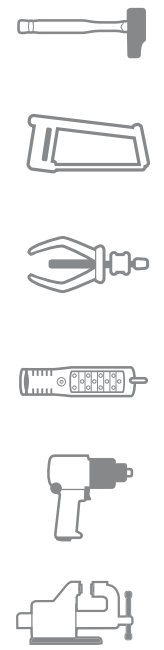

- Hinged sockets..... 1034
- Bristol wrenches..... 1034
- Torq Set® - Tri-wing bits..... 1035
- Special pliers..... 1036



# FACOM AEROSPACE



## AEROSPACE SOLUTIONS SINCE 1918



**FACOM** now at the heart of the Industrial & Automotive Repair division of the **Stanley Black & Decker group**, is an organisation which provides coherent, integral and competitive solutions with the same level of quality and service throughout the world.

- The Facom Aerospace catalogue is supplemented with products by **PROTO**, one of the US leaders in aerospace maintenance to complete the US dimension hand tool offer.
- Storage solutions and power tools by other group brands also extend the range of solutions available.
- FACOM also works in partnership with its customers from the aeronautical sector to develop the FOD solutions of the future, including innovative tool detection systems.



### FACOM SERVICE: CONTROLLED TORQUE

Facom calibration laboratory accredited by Cofrac delivers:

- Cofrac calibration certificates.
- Facom calibration certificates.



ACCREDITATION N° 2-1934. Range available on [www.cofrac.fr](http://www.cofrac.fr)

# SAFETY FIRST | NEW RANGE OF FLUORESCENT TOOLS

## YOUR FOD SFLB solution for "BLACK OR DIMLY LIT AREAS"

### SAFETY FIRST

- No tools lost or forgotten.
- Tool visibility.

### COST REDUCTION

- Less tools replaced due to loss.

Detect the tool thanks to its fluorescence, activated by a lamp or UV neon light.

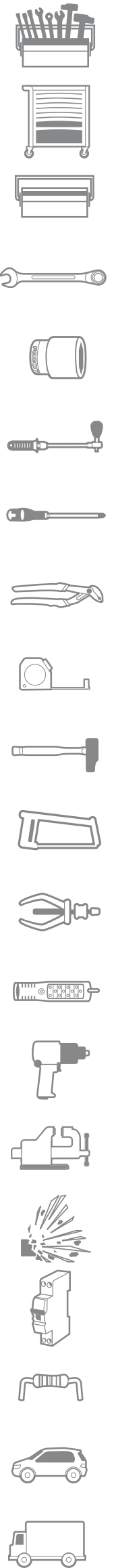
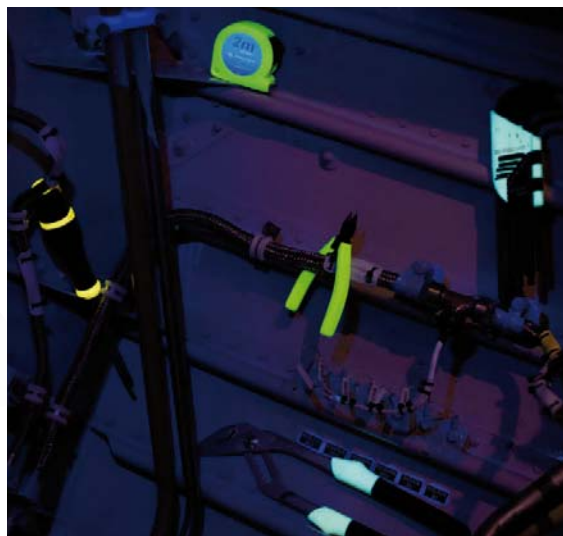

## PROTWIST® FLUO screwdriver

### AN.F - PROTWIST® fluorescent screwdrivers for slotted head screws - milled blade

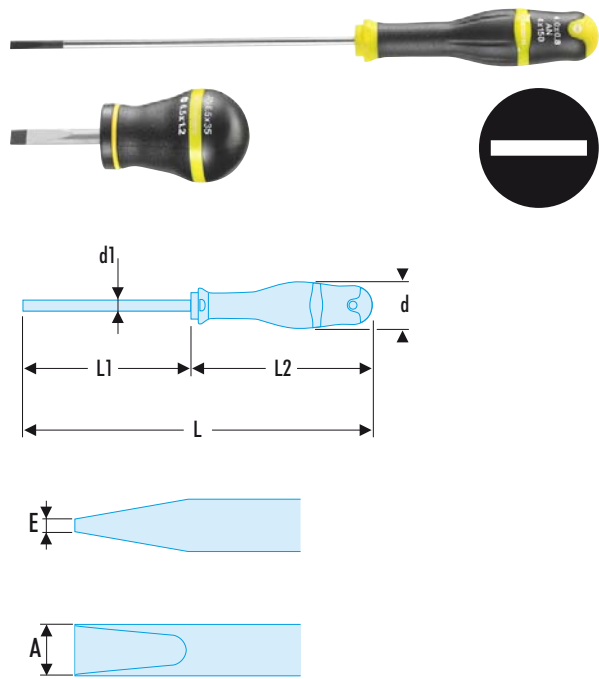

NF ISO 2380-1, NF ISO 2380-2, ISO 2380-1, ISO 2380-2, DIN ISO 2380-1, DIN ISO 2380-2, ASME B107.600

- Detect the tool thanks to its fluorescence, activated by a lamp or UV neon light.
- Silicon carbon blade: strong and resistant to flexion.
- Bi-material grip resists to impacts, abrasion, and chemicals.

➤	A [mm]	E [mm]	d [mm]	d1 x L1 [mm]	L [mm]	L2 [mm]	ΔΔ [g]
<b>AN2,5X75F</b>	2,5	0,4	19	2,5 x 75	169	94	21
<b>AN3,5X100F</b>	3,5	0,6	25	3,5 x 100	203	103	43
<b>AN4X35F</b>	4,0	0,8	36	4,0 x 35	91	56	36
<b>AN4X100F</b>	4,0	0,8	30	4,0 x 100	209	109	47
<b>AN4X150F</b>	4,0	0,8	30	4,0 x 150	259	109	52
<b>AN5,5X150F</b>	5,5	1,0	30	5,5 x 150	259	109	91
<b>AN6,5X35F</b>	6,5	1,2	36	6,5 x 35	91	56	46
<b>AN6,5X150F</b>	6,5	1,2	36	6,5 x 150	270	120	140

### AW.F - PROTWIST® fluorescent screwdrivers for slotted head screws - hexagonal blade

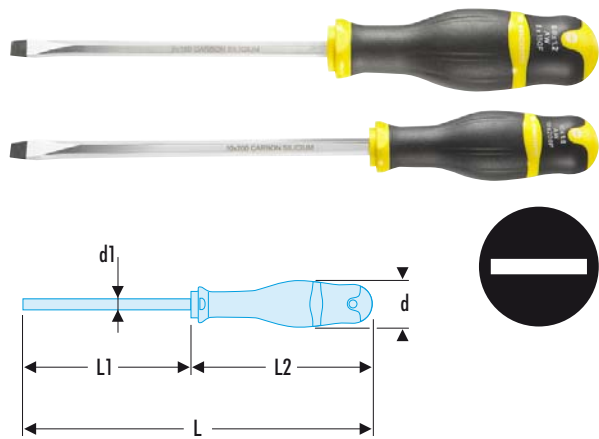

NF ISO 2380-1, NF ISO 2380-2, ISO 2380-1, ISO 2380-2, DIN ISO 2380-1, DIN ISO 2380-2, ASME B107.600

- Detect the tool thanks to its fluorescence, activated by a lamp or UV neon light.
- Silicon carbon blade: strong and resistant to flexion.
- Bi-material grip resists to impacts, abrasion, and chemicals.

➤	d [mm]	d1 x L1 [mm]	L [mm]	L2 [mm]	ΔΔ [g]
<b>AW8X150F</b>	40	7 x 150	275	125	220
<b>AW10X200F</b>	40	9 x 200	325	125	255

### ANP.F - PROTWIST® fluorescent screwdrivers for Phillips® screws - milled blade

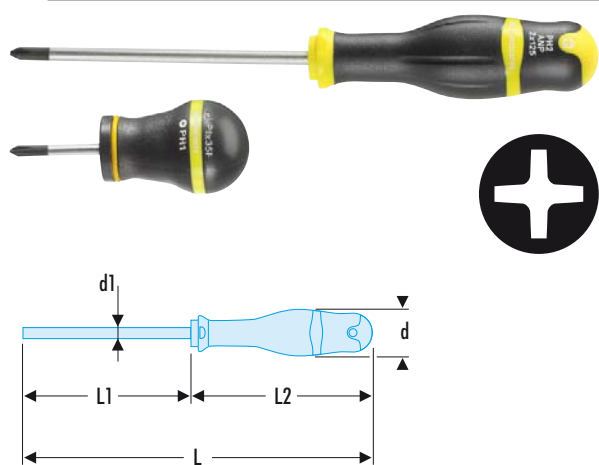

NF ISO 8764-1, NF ISO 8764-2, ISO 8764-1, ISO 8764-2, DIN ISO 8764-1, DIN ISO 8764-2, ASME B107.600

- Detect the tool thanks to its fluorescence, activated by a lamp or UV neon light.
- Silicon carbon blade: strong and resistant to flexion.
- Bi-material grip resists to impacts, abrasion, and chemicals.

➤	Phillips [No]	d [mm]	d1 x L1 [mm]	L [mm]	L2 [mm]	ΔΔ [g]
<b>ANPOX75F</b>	PH0	25	3,0 x 75	178	103	45
<b>ANP1X35F</b>	PH1	36	4,5 x 35	91	56	39
<b>ANP1X100F</b>	PH1	30	4,5 x 100	209	109	76
<b>ANP2X35F</b>	PH2	36	6,0 x 35	91	56	44
<b>ANP2X125F</b>	PH2	36	6,0 x 125	245	120	126
<b>ANP3X150F</b>	PH3	40	8,0 x 150	275	125	194
<b>ANP4X200F</b>	PH4	30	4,0 x 200	309	109	57

AWPF - PROTWIST® fluorescent screwdrivers for Phillips® screws - hexagonal blade

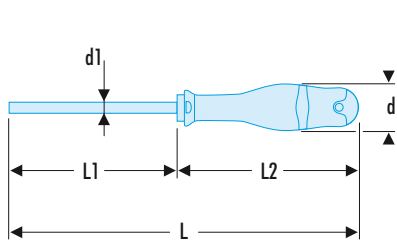

NF ISO 8764-1, NF ISO 8764-2, ISO 8764-1, ISO 8764-2, DIN ISO 8764-1, DIN ISO 8764-2, ASME B107.600

- Detect the tool thanks to its fluorescence, activated by a lamp or UV neon light.
- Hexagonal blade: optimum endurance and performance.
- Silicon carbon blade: strong and resistant to flexion.
- Bi-material grip resists to impacts, abrasion, and chemicals.

	Phillips [No]	d [mm]	d1 x L1 [mm]	L [mm]	L2 [mm]	ΔΔ [g]
<b>AWP2X125F</b>	2	36	6 x 125	245	120	130

R.236AF PROTWIST® fluorescent handle screwdriver 1/4" - 158 mm



NF ISO 3315, ISO 3315, DIN 3122, ASME B107.10

- Detect the tool thanks to its fluorescence, activated by a lamp or UV neon light.
- Bi-material grip resists to impacts, abrasion, and chemicals.
- Finish: chromed.

PROTWIST® fluorescent bit holder screwdriver

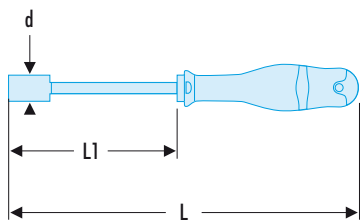

- Detect the tool thanks to its fluorescence, activated by a lamp or UV neon light.
- Long magnetic bit holders.
- Bi-material grip resists to impacts, abrasion, and chemicals.

	d [mm]	L [mm]	L [mm]	ΔΔ [g]
<b>AM.M2F</b>	10	245	245	150

PROTWIST® FLUO keys

AWSH.F - PROTWIST® fluorescent handle hexagonal key - spherical head

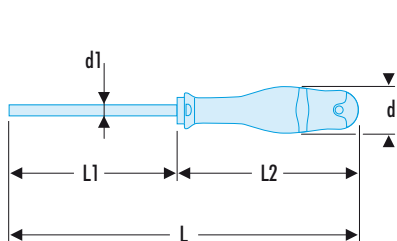

- Detect the tool thanks to its fluorescence, activated by a lamp or UV neon light.
- Bi-material grip resists to impacts, abrasion, and chemicals.

	A [mm]	d [mm]	d1 [mm]	L [mm]	L2 [mm]	ΔΔ [g]
<b>AWSH3X75F</b>	3	19	3	169	94	35
<b>AWSH4X75F</b>	4	25	4	178	103	45
<b>AWSH5X100F</b>	5	30	5	208	109	80

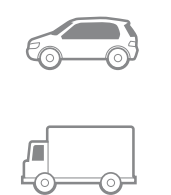
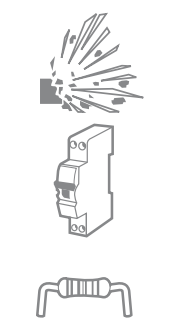
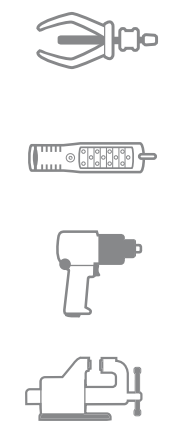
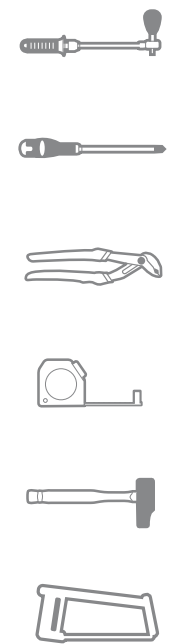
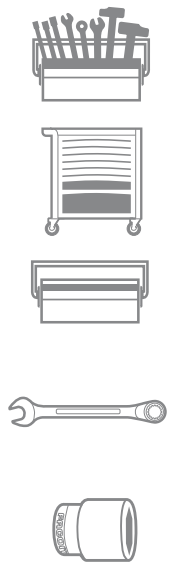

## PROTWIST® FLUO key sleeve set

### ▣ 83SH.JP8UF 8-piece FLUO hexagonal key sleeve set



- Detect the tool thanks to its fluorescence, activated by a lamp or UV neon light.
- Keys are packaged in a compact wallet for easy selection of the dimension required.
- Inch 8 key sets 83SH:  
- 3/32" - 1/8" - 5/32" - 3/16" - 7/32" - 1/4" - 5/16" - 3/8".  
Weight: 365 g.



### ▣ 83SH.JP9F 9-piece FLUO hexagonal key sleeve set



- Detect the tool thanks to its fluorescence, activated by a lamp or UV neon light.
- Keys are packaged in a compact wallet for easy selection of the dimension required.
- Metric 9 keys sets 83SH:  
- 1.5 - 2.0 - 2.5 - 3.0 - 4.0 - 5.0 - 6.0 - 8.0 - 10 mm.  
Weight: 380 g.

## FLUO pliers

### Slip-joint multigrip pliers with fluorescent grips

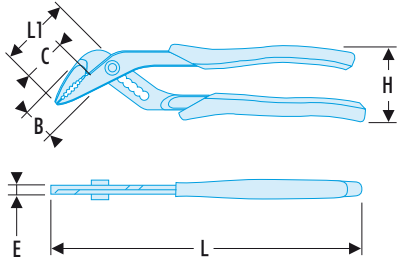

NF ISO 8976, ISO 8976, DIN ISO 8976, ASME B107.500

- Detect the tool thanks to its fluorescence, activated by a lamp or UV neon light.
- Capacity: 44 mm.
- Ideal for confined spaces: Long reach thin noses.
- Double heat-treated tips: high wear resistance, hardness 60/62 HRc.
- Finish: chromed, bi-material ergonomic grips.

	B [mm]	C [mm]	E [mm]	E1 [mm]	L [mm]	L1 [mm]
<b>180.CPEF</b>	30	35	8	22	250	58

### Slip-joint locking multigrip pliers with fluorescent grips

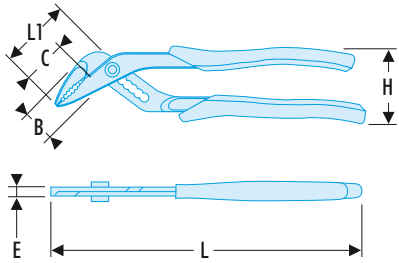

NF ISO 8976, ISO 8976, DIN ISO 8976, ASME B107.500

- Detect the tool thanks to its fluorescence, activated by a lamp or UV neon light.
- Fast, precise push-button adjustment with safety lock.
- Self-tightening.
- Double heat-treated noses; hardness 60/62 HRc.
- Finish: chromed.

	A [mm]	C [mm]	E [mm]	Capacity Nuts [mm]
<b>181.25CPEF</b>	33,8	55	28	41

### 192.CPEF - Diagonal cutters with fluorescent grips

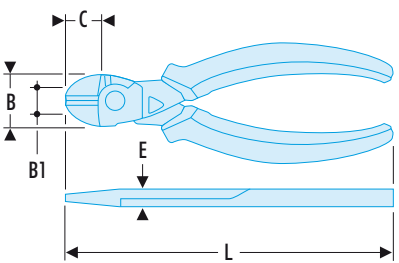

NF ISO 5749, ISO 5749, DIN ISO 5749, ASME B107.500

- Detect the tool thanks to its fluorescence, activated by a lamp or UV neon light.
- Cutting edges designed to cleanly cut through all types of wire: piano wire, soft wires and modern materials (max. 200 kg/mm<sup>2</sup>).
- Long lever arm, offset pivot for minimum cutting effort.
- High durability Chrome-Molybdenum-Vanadium steel, very hard cutting edges 61/63 HRc.
- Ergonomic grips resistant to chemical agents.
- Removable return spring.
- Finish: chromed.

	B [mm]	C [mm]	d maxi [mm]	E [mm]	L [mm]	ΔΔ [g]
<b>192.14CPEF</b>	21,5	15,5	1,5	9,5	145	160
<b>192.20CPEF</b>	28,0	22,0	2,5	11,5	200	320

### Front cutters with fluorescent grips

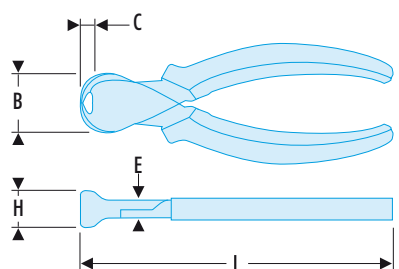

NF ISO 5748, ISO 5748, DIN ISO 5748, ASME B107.500

- Detect the tool thanks to its fluorescence, activated by a lamp or UV neon light.
- Cutting edges designed to cleanly cut through all types of wire: piano wire, hard and soft wires (max. 200 kg/mm<sup>2</sup>).
- Long lever arm, offset pivot for minimum cutting effort.
- High durability Chrome-Molybdenum-Vanadium steel, very hard cutting edges 61/63 HRc.
- Ergonomic grips resistant to chemical agents.
- Removable return spring.
- Finish: chromed.

	A [mm]	B [mm]	C [mm]	E [mm]	L [mm]	ΔΔ [g]
<b>190.20CPEF</b>	7,5	31	7,5	13,5	200	340

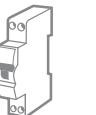
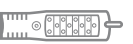



## Long-reach half-round nose pliers with fluorescent grips

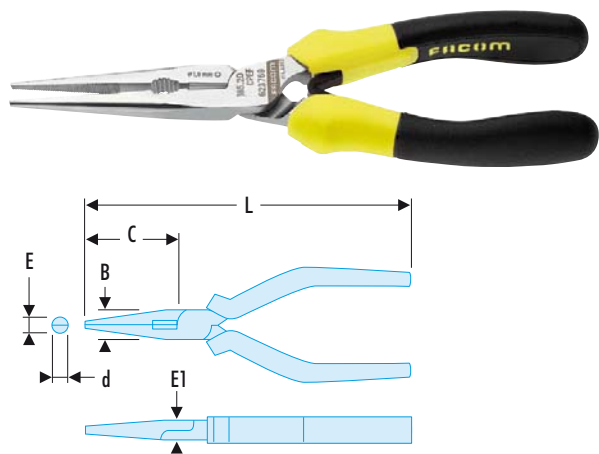

NF ISO 5745, ISO 5745, DIN ISO 5745, ASME B107.500

- Detect the tool thanks to its fluorescence, activated by a lamp or UV neon light.
- Narrow, finely serrated tips with a pipe-grip.
- Side cutter for copper and hard steel wire (max. 160 kg/mm<sup>2</sup>).
- Ergonomic grips resistant to chemical agents.
- Removable return spring.
- Finish: chromed.

	B [mm]	C [mm]	d [mm]	E [mm]	E1 [mm]	L [mm]	ΔΔ [g]
<b>185.20CPEF</b>	18	75	2,9	3,6	9	200	200

## Long-reach slim half-round nose pliers with fluorescent grips

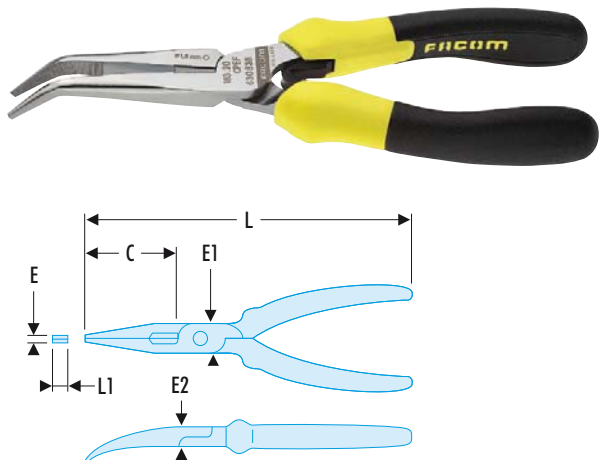

NF ISO 5745, ISO 5745, DIN ISO 5745, ASME B107.500

- Detect the tool thanks to its fluorescence, activated by a lamp or UV neon light.
- Narrow, finely serrated tips, 40° angled nose.
- Side cutter for copper and hard steel wire (max. 160 kg/mm<sup>2</sup>).
- Ergonomic grips resistant to chemical agents.
- Removable return spring.
- Finish: chromed.

	C [mm]	E [mm]	E1 [mm]	E2 [mm]	L [mm]	L1 [mm]	ΔΔ [g]
<b>183.20CPEF</b>	69	3	18	9	200	2,5	185

## Short half-round nose pliers with fluorescent grips

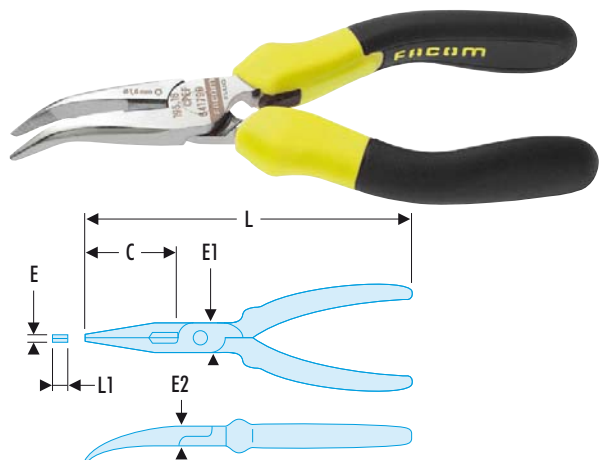

NF ISO 5745, ISO 5745, DIN ISO 5745, ASME B107.500

- Detect the tool thanks to its fluorescence, activated by a lamp or UV neon light.
- Narrow, finely serrated tips, 40° angled, with a pipe-grip.
- Side cutter for copper and hard steel wire (max. 160 kg/mm<sup>2</sup>).
- Ergonomic grips resistant to chemical agents.
- Removable return spring.
- Finish: chromed.

	B [mm]	C [mm]	d [mm]	E [mm]	E1 [mm]	L [mm]	ΔΔ [g]
<b>195.16CPEF</b>	17	50	2,5	3	9	160	177

## Combination pliers with fluorescent grips

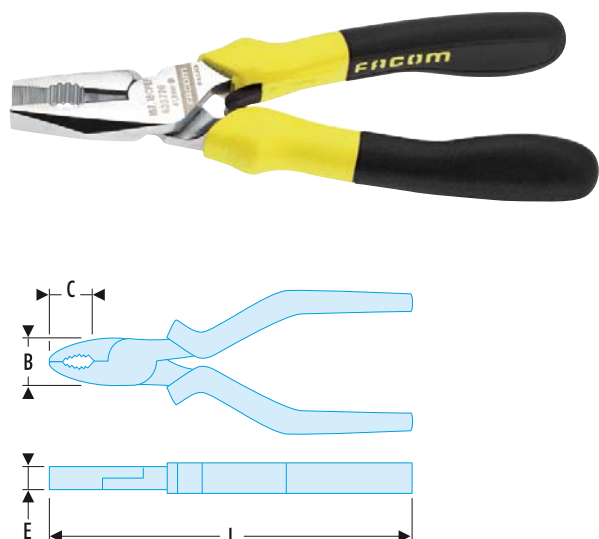

NF ISO 5746, ISO 5746, DIN ISO 5746, ASME B107.500

- Detect the tool thanks to its fluorescence, activated by a lamp or UV neon light.
- Cutting edges designed to cut through all types of wire: piano wire, soft wires and modern materials (max. Fe 200 kg/mm<sup>2</sup>).
- Long lever arm, offset pivot for minimum cutting effort.
- High durability Chrome-Molybdenum-Vanadium steel, very hard cutting edges 61/63 HRc.
- Ergonomic grips resistant to chemical agents.
- Removable return spring.
- Finish: chromed.

	B [mm]	C [mm]	E [mm]	L [mm]	ΔΔ [g]
<b>187.16CPEF</b>	21	34	9,5	165	195

## Flat nose pliers with fluorescent grips

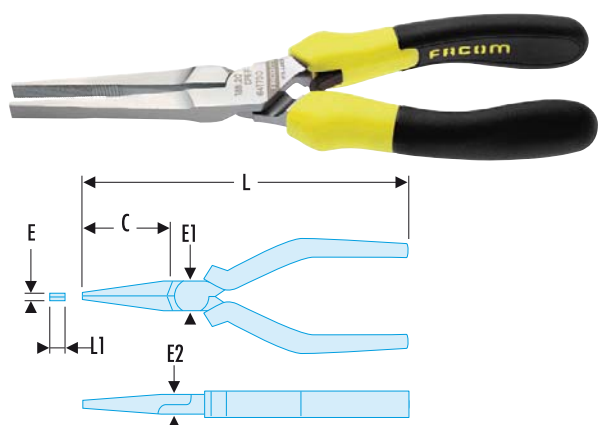

NF ISO 5745, ISO 5745, DIN ISO 5745, ASME B107.500

- Detect the tool thanks to its fluorescence, activated by a lamp or UV neon light.
- Serrated nose for stronger grip.
- Ergonomic grips resistant to chemical agents.
- Removable return spring.
- Finish: chromed.

	C [mm]	E [mm]	E1 [mm]	E2 [mm]	L [mm]	L1 [mm]	ΔΔ [g]
<b>188.20CPEF</b>	75	4	18	9	200	6,5	200

## Micro-Tech® "heavy-duty" cutters with fluorescent grips

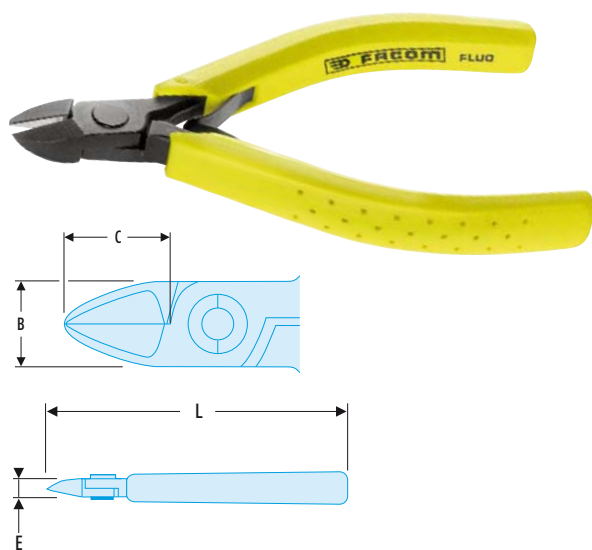

NF ISO 9654, ISO 9654, DIN ISO 9654, ASME B107.500

- Detect the tool thanks to its fluorescence, activated by a lamp or UV neon light.
- Pliers for clear cutting multiple materials: from copper wire to piano wire up to 0.5 mm.

	B [mm]	C [mm]	E [mm]	L [mm]	Cu - Ni wire diameter [mm]	Fe wire 30 HRc diameter [mm]	Cut	ΔΔ [g]
<b>405.10MTF</b>	10,5	11,5	7	110	0,3 - 1,4	0,8	∧	60

## Micro-Tech® long-reach cutters with fluorescent grips

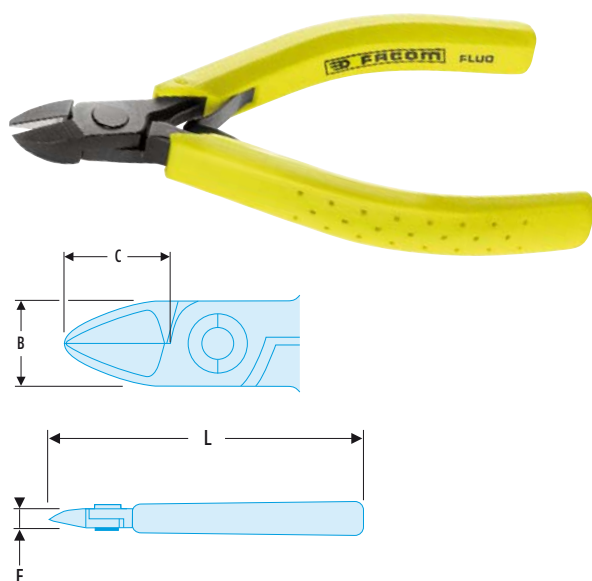

NF ISO 9654, ISO 9654, DIN ISO 9654, ASME B107.500

- Detect the tool thanks to its fluorescence, activated by a lamp or UV neon light.
- Long-reaching pliers up to 1.5 to 2 mm more than with standard pliers.
- The model with retention system prevents the wire from being ejected.

	B [mm]	C [mm]	E [mm]	L [mm]	Cu - Ni wire diameter [mm]	Cut	ΔΔ [g]
<b>425F</b>	10,5	13	7	110	0,1 - 1,3	┌	60

## Micro-Tech® gripping pliers with fluorescent grips

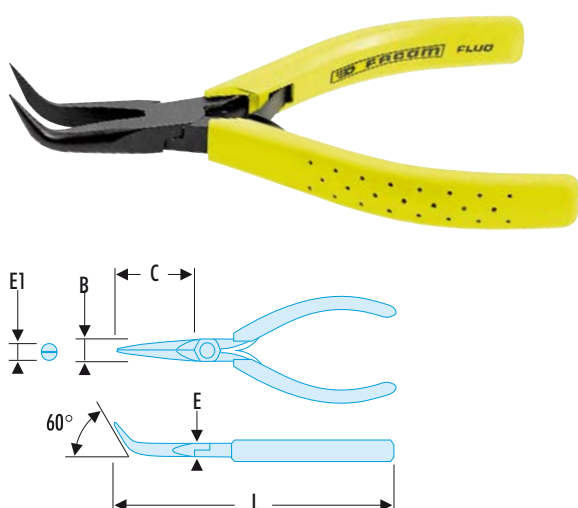

NF ISO 9655, ISO 9655, DIN ISO 9655, ASME B107.500

- Detect the tool thanks to its fluorescence, activated by a lamp or UV neon light.
- Rigid jaws, angled 60°.

	B [mm]	C [mm]	E [mm]	E1 [mm]	L [mm]	ΔΔ [g]
<b>423.MTF</b>	11	25	7	1,4	125	70

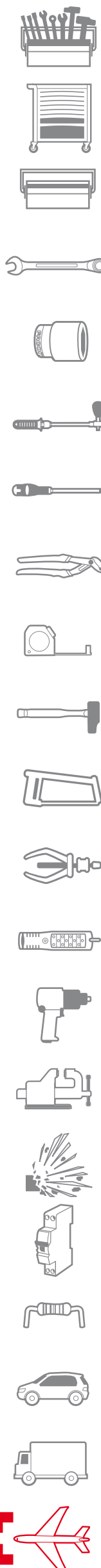

## Outside Circlip® pliers with fluorescent grips - straight nose



NF E 73-130, DIN 5254, ASME B107.500

- Detect the tool thanks to its fluorescence, activated by a lamp or UV neon light.
- For Circlips® 19 --> 60 mm.

➤	d [mm]	d mini - maxi [mm]	L [mm]
<b>177A.18F</b>	1,8	19 - 60	180

## Outside Circlip® pliers with fluorescent grips - 90° angled



NF E 73-130, DIN 5254, ASME B107.500

- Detect the tool thanks to its fluorescence, activated by a lamp or UV neon light.
- For Circlips® 19 --> 60 mm.

➤	d [mm]	d mini - maxi [mm]	L [mm]	ΔΔ [g]
<b>197A.18F</b>	1,8	19 - 60	170	175

## Inside Circlip® pliers with fluorescent grips - straight nose



NF E 73-130, DIN 5256, ASME B107.500

- Detect the tool thanks to its fluorescence, activated by a lamp or UV neon light.
- For Circlips® 19 --> 60 mm.

➤	d [mm]	d mini - maxi [mm]	L [mm]	ΔΔ [g]
<b>179A.18F</b>	1,8	19 - 60	185	215

## Inside Circlip® pliers with fluorescent grips - 45° angled



NF E 73-130, DIN 5256, ASME B107.500

- Detect the tool thanks to its fluorescence, activated by a lamp or UV neon light.
- For Circlips® 19 --> 60 mm.

➤	d [mm]	d mini - maxi [mm]	L [mm]	ΔΔ [g]
<b>199A.18F</b>	1,8	19 - 60	170	215

## 467FLUO Outside Circlip® pliers with fluorescent grips

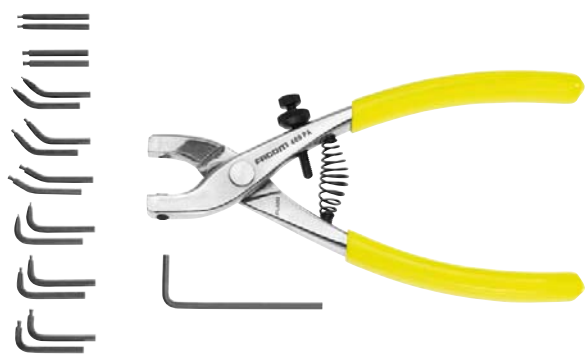

NF E 73-130DIN 5254, ASME B107.500

- Detect the tool thanks to its fluorescence, activated by a lamp or UV neon light.
  - Interchangeable tips for a capacity of diam. 8 --> 63 mm.
  - Thumbscrew position setting.
  - Opening return spring.
  - Finish: chrome finish, PVC grip.
  - Supplied in a case with key and set of bits E1 - E2 - E3 - E5 - E6 - E8 - E9.
- Weight: 160 g.

## 469F Inside Circlip® pliers with fluorescent grips

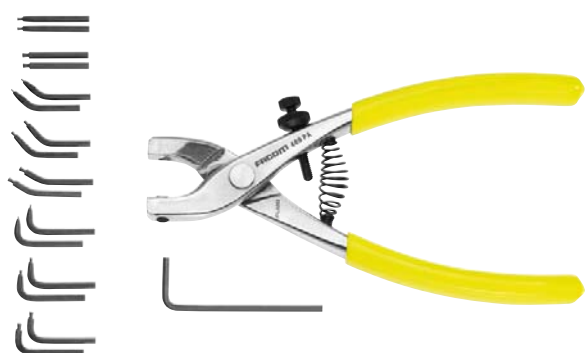

NF E 73-130DIN 5256, ASME B107.500

- Detect the tool thanks to its fluorescence, activated by a lamp or UV neon light.
  - Interchangeable tips for a capacity of diam. 8 --> 63 mm.
  - Thumbscrew position setting.
  - Opening return spring.
  - Finish: chrome finish, PVC grip.
  - Supplied in a case with key and set of bits E1 - E2 - E3 - E5 - E6 - E8 - E9.
- Weight: 160 g.

Ring wrenches

Long-reach ring wrenches

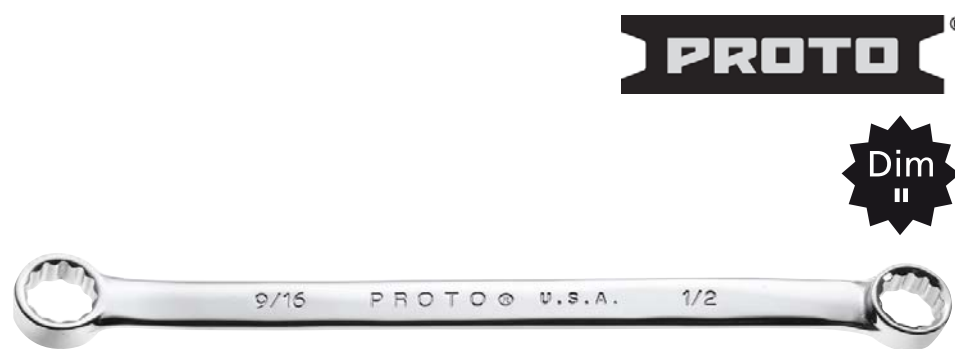

ASME B107.100

- Bright finish.
- 12-pin for more secure nut tightening, improving speed and grip. Suitable for 4 - 6 - 12 point.

➤	A ["]	L [mm]	ΔΔ [g]
<b>J1151</b>	1-1/16x1-1/4	464	826
<b>J1155</b>	1-1/4x1-5/16	489	894
<b>J1160</b>	1-1/4x1-3/8	514	1007
<b>J1162</b>	1-7/16x1-1/2	565	1352
<b>J1164</b>	1-5/8x1-11/16	616	1696

Spline profile tools

Spline profile ring wrenches



ASME B107.100

- Bright finish.
- ASME B107.100: ring and performance specification.
- MS33787: spline profile specification.

➤	A ["]	L [mm]	ΔΔ [g]
<b>J1118SPL</b>	1/4x5/16	184	54
<b>J1122SPL</b>	3/8x7/16	229	82
<b>J1126SPL</b>	1/2x9/16	229	154
<b>J1130SPL</b>	9/16x5/8	248	181
<b>J1135SPL</b>	11/16x3/4	279	340
<b>J1142SPL</b>	13/16x15/16	324	467
<b>J1144SPL</b>	7/8x1	337	490

Spline profile combination wrenches



- Bright finish.
  - Open end: anti-slip design.
  - ASME B107.100: ring and performance specification.
  - MS33787: spline profile specification.
- Total head height: 18 mm.

➤	A ["]	L [mm]	ΔΔ [g]
<b>J1208SPL</b>	1/4	125	27
<b>J1209SPL</b>	9/32	131	32
<b>J1210SPL</b>	5/16	138	36
<b>J1211SPL</b>	11/32	144	41
<b>J1212SPL</b>	3/8	150	45
<b>J1214SPL</b>	7/16	176	64
<b>J1216SPL</b>	1/2	201	91
<b>J1218SPL</b>	9/16	224	118
<b>J1220SPL</b>	5/8	242	154
<b>J1222SPL</b>	11/16	261	191
<b>J1224SPL</b>	3/4	280	227
<b>J1226SPL</b>	13/16	300	268
<b>J1228SPL</b>	7/8	318	331
<b>J1230SPL</b>	15/16	338	408
<b>J1232SPL</b>	1	357	499

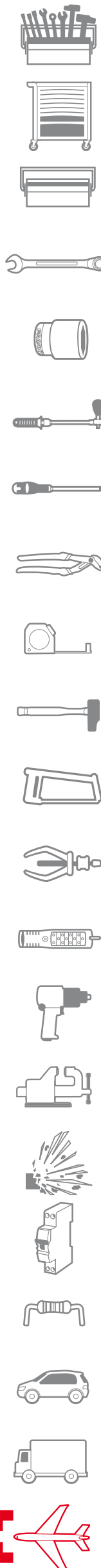

## SBV - Spline profile head ratchet ring wrenches



- Profile suited to "high strength" spline fasteners.
- Compatible with 12-point and 6-point inch fasteners.
- Heads tilted by 15°.
- 5° increments.
- High performance level.
- High head capacity.
- Finish: black chromium.

⇒	A ["]	L [mm]	ΔΔ [g]
<b>SBV0709</b>	7/32 x 9/32	114	36
<b>SBV0810</b>	1/4 x 5/16	114	36
<b>SBV1214</b>	3/8 x 7/16	151	54
<b>SBV1618</b>	1/2 x 9/16	179	104
<b>SBV2022</b>	5/8 x 11/16	200	159
<b>SBV2428</b>	3/4 x 7/8	245	259
<b>SBV2630</b>	13/16 x 15/16	260	381
<b>SBV3236</b>	1 x 1 1/8	330	431

## 1/4" Spline profile sockets

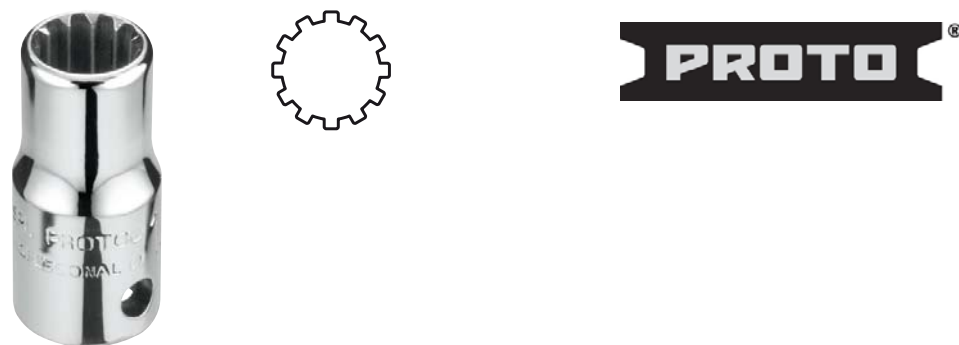

- Profile suited to "high strength" spline fasteners.
- Compatible with 12-point and 6-point inch fasteners.
- Thin walls.
- High performance level.
- Finish: chromed.

⇒	A ["]	L [mm]	ΔΔ [g]
<b>J4706SPL</b>	3/16	23	9
<b>4707SPL</b>	7/32	23	9
<b>4708SPL</b>	1/4	23	9
<b>4709SPL</b>	9/32	23	9
<b>4710SPL</b>	5/16	23	14
<b>4712SPL</b>	3/8	23	18
<b>4714SPL</b>	7/16	26	23

## 1/4" Long-reach spline profile sockets



- Profile suited to "high strength" spline fasteners.
- Compatible with 12-point and 6-point inch fasteners.
- Thin walls.
- High performance level.
- Finish: chromed.

⇒	A ["]	L [mm]	ΔΔ [g]
<b>J4706DPL</b>	3/16	51	14
<b>J4707DPL</b>	7/32	51	18
<b>4708DPL</b>	1/4	51	18
<b>J4709DPL</b>	9/32	51	23
<b>4710DPL</b>	5/16	51	27
<b>J4712DPL</b>	3/8	51	36
<b>J4714DPL</b>	7/16	51	41

3/8" long-reach spline profile sockets



- Profile suited to "high strength" spline fasteners.
- Compatible with 12-point and 6-point inch fasteners.
- Thin walls.
- High performance level.
- Finish: chromed.

➤	A ["]	d1 [mm]	d2 [mm]	L [mm]	ΔΔ [g]
<b>5012DPL</b>	3/8	13.8	16.8	53.4	36
<b>5014DPL</b>	7/16	16	17.25	53.65	43
<b>5016DPL</b>	1/2	18.3	18.3	59.95	54
<b>5018DPL</b>	9/16	20.9	20.9	60.3	83
<b>5020DPL</b>	5/8	22.6	22.6	60.4	96

Crowfoot bits

12-point high crowfoot flare bits 3/8"

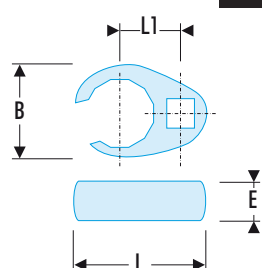

- Thin wall 12-point high heads.
- Built to aeronautical specifications.
- 3/8" square drive bit.
- Dimensions: 5/8 --> 1 1/16.
- Finish: chromed.

➤	A ["]	E [mm]	B [mm]	C [mm]	L [mm]	ΔΔ [g]
<b>4920FL</b>	5/8	24,2	18,3	24,2	19,05	40
<b>4922FL</b>	11/16	26,3	18,3	26,3	20,20	44
<b>4924FL</b>	3/4	29,2	18,3	29,2	21,40	53
<b>4926FL</b>	13/16	31,1	18,9	31,1	22,60	56
<b>4928FL</b>	7/8	33,8	19,3	33,8	25,00	67
<b>4930FL</b>	15/16	35,9	19,0	35,9	24,20	68
<b>4932FL</b>	1	37,7	19,8	37,7	26,20	77
<b>4934FL</b>	1-1/16	39,5	20,0	39,5	27,00	84

J5100 9-piece set of 12-point 3/8" drive adaptors



- Length 2" between the centre of the square and the centre of the ring.
- Ring profile design guaranteeing mechanical strength while allowing use in confined spaces.
- Dimensions: 3/8" - 7/16" - 1/2" - 9/16" - 5/8" - 11/16" - 3/4" - 13/16" - 7/8".

1/2" crowfoot open end bits



- Open end: anti-slip design ensuring proper fitting of the crowfoot on the bolt.
- 1/2" square drive bit.

➤	A ["]	L [mm]	ΔΔ [g]
<b>J5334CF</b>	1-11/16	73	231
<b>J5336CF</b>	1-1/8	76	245
<b>J5338CF</b>	1-3/16	76	263
<b>J5340CF</b>	1-1/4	84	299
<b>J5342CF</b>	1-5/16	84	299
<b>J5344CF</b>	1-3/8	86	327
<b>J5346CF</b>	1-7/16	86	340
<b>J5348CF</b>	1-1/2	87	349
<b>J5350CF</b>	1-9/16	89	363
<b>J5352CF</b>	1-5/8	89	376
<b>J5354CF</b>	1-11/16	97	431
<b>J5356CF</b>	1-3/4	97	445
<b>J5358CF</b>	1-13/16	98	458
<b>J5360CF</b>	1-7/8	98	478
<b>J5364CF</b>	2	100	499

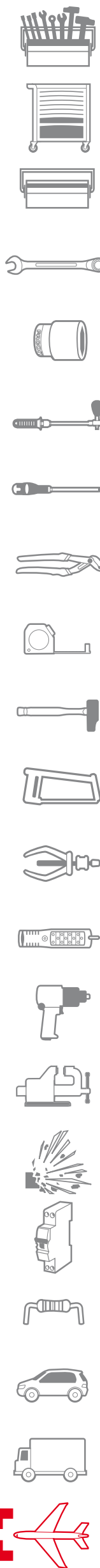

## Tools for aerospace fasteners

### TOOLS FOR AIRCRAFT FASTENERS

#### 1/4" AND 3/8" RATCHETS FOR INSTALLING AIRCRAFT FASTENERS

Used with "standard" 1/4" and 3/8" square drive sockets.

- The sockets are locked onto square drive by a metal clip.

The ratchet head includes a hole for inserting a key

- to prevent rotation of the fastener during tightening.



#### ▣ 4749XLHS 1/4" ratchet for aerospace fasteners



NF ISO 3315, ISO 3315, DIN 3122, ASME B107.10, AS 4283

- Hole in 1/4" head and drive bit for passing keys.
- Smaller shape and volume for better accessibility.
- Increment: 8°.
- Head diameter: 21.5 mm.
- Total head height: 18 mm.
- Length: 144 mm.
- Weight: 115 g.

#### ▣ 5249XLHS 3/8" ratchet for aerospace fasteners



NF ISO 3315, ISO 3315, DIN 3122, ASME B107.10, AS 4283

- Hole in 3/8" head and drive bit for passing keys.
- Smaller shape and volume for better accessibility.
- Increment: 8°.
- Head diameter: 33 mm.
- Total head height: 27 mm.
- Length: 215 mm.
- Weight: 400 g.

1/2" metal handle ratchet

▣ "Palm control" 1/2" ratchet with metal handle

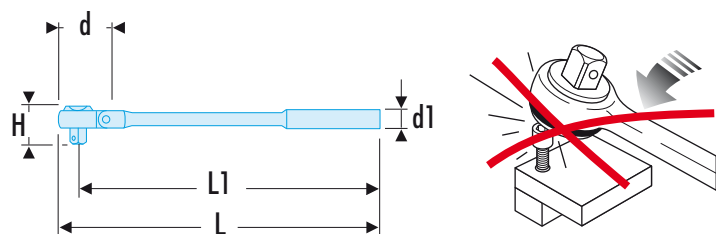

- Long-reach stiffened hinge ratchet allowing to clear an obstacle.
- Increment: 5°.
- "Palm control" switch.
- Finish: satin chrome.

▣	d [mm]	d1 [mm]	H [mm]	L [mm]	ΔΔ [g]
<b>S.158A</b>	42	20	40	435	940

3/8" metal handle ratchet

▣ "Palm control" 3/8" long-reach ratchet with metal handle

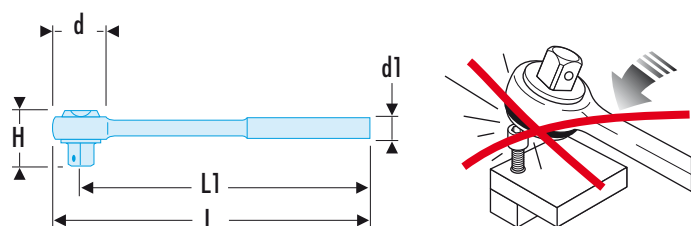

NF ISO 3315, ISO 3315, DIN 3122, ASME B107.10

- Stiffened hinge handle allowing to clear an obstacle.
- Increment: 5°.
- "Palm control" switch.
- Finish: satin chrome.
- Weight: 360 g.

▣	d [mm]	d1 [mm]	H [mm]	L [mm]	ΔΔ [g]
<b>J.158A</b>	30	16	32	273	350

1/4" metal handle ratchet

▣ "Palm control" 1/4" long-reach ratchet with metal handle

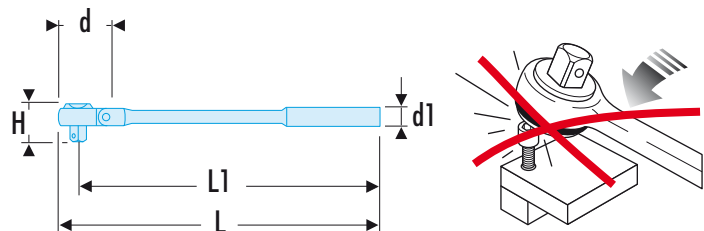

- Increment: 5°.
- Stiffened hinge handle allowing to clear an obstacle.
- Finish: satin chrome.

▣	d [mm]	d1 [mm]	H [mm]	L [mm]	ΔΔ [g]
<b>R.158A</b>	25	11	26,5	158	135

▣ **R.150A** 1/4" ratchet without handle

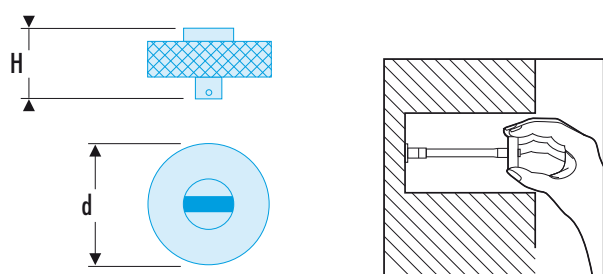

- Increment: 5°.
- Finish: satin chrome.
- Weight: 95 g.

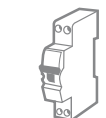



## ▣ 65.PE Bit-holder ratchet wrench 1/4" - 5/16"



- Takes the following bits:
    - Series 1: hexagon 1/4".
    - Series 2: hexagon 5/16".
  - Used for installing 1/4" and 5/16" aircraft fasteners.
  - Increment: 5°.
  - Heads angled at 15°.
  - Bits held by a spring clip.
  - Knurled head for fast pre-tightening.
  - Length 150 mm.
  - Satin chrome finish.
- Weight: 74 g.

## Hinged sockets

### ▣ 1/2" hinged sockets



ASME B107.1, AS954G

▣	A ["]	L [mm]	ΔΔ [g]
<b>J5475A</b>	1/2	63	113
<b>J5477A</b>	9/16	67	118
<b>J5476A</b>	5/8	67	122

### ▣ J47107 9-piece set of 1/4" hinged sockets



- 9 sockets: 7/32" - 1/4" - 9/32" - 5/16" - 11/32" - 3/8" - 7/16" - 1/2" - 9/16".
- Weight: 213 g.

### ▣ 1/4" knurled extensions



- Finish: chromed.

▣	L [mm]	ΔΔ [g]
<b>J4759</b>	51	23
<b>J4760</b>	76	36
<b>J4761</b>	152	68
<b>J4762</b>	254	109
<b>J4763</b>	259	136

## Bristol wrenches

### ▣ 85.JU10 Set of 10 wrenches for Bristol head screws



- Set of 10 85 keys: 033 - 048 - 060 - 072 - 096 - 111 - 133 - 145 - 168 - 183.
  - Supplied in roll.
- Weight: 37 g.

Torq Set® - Tri-wing bits

ETOR - 1/4" bits for Torq Set® head screws



NF ISO 1173, ISO 1173

⇒	L [mm]	Screw Size[mm]	ΔΔ [g]
<b>ETOR.100</b>	25	0	5,50
<b>ETOR.101</b>	25	1	5,50
<b>ETORM.103</b>	25	3	6,00
<b>ETORM.104</b>	25	4	6,00
<b>ETORM.105</b>	25	5	6,00
<b>ETORM.106</b>	25	6	6,00
<b>ETORM.108</b>	25	8	6,00
<b>ETORM.110</b>	25	10	6,00
<b>ETORM.101/4</b>	32	1/4	13,00

ETORM.6 - 1/4" grooved bits for Torq Set® head screws

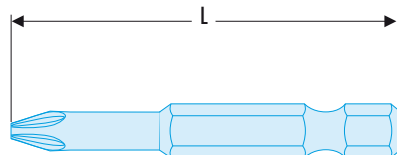

NF ISO 1173, ISO 1173

⇒	Torq-set [No]	L [mm]	ΔΔ [g]
<b>ETORM.602</b>	2	50	12
<b>ETORM.603</b>	3	50	12
<b>ETORM.604</b>	4	50	12
<b>ETORM.605</b>	5	50	12
<b>ETORM.606</b>	6	50	12
<b>ETORM.608</b>	8	50	12
<b>ETORM.610</b>	10	50	12
<b>ETORM.601/4</b>	1/4	50	12

ETORM.2 - For Torq Set® screw head

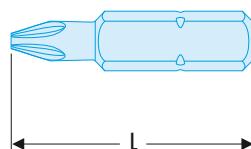

NF ISO 1173, ISO 1173

⇒	L [mm]	Screw Size[mm]	ΔΔ [g]
<b>ETORM.208</b>	32	8	14
<b>ETORM.210</b>	32	10	14
<b>ETORM.201/4</b>	32	1/4	14
<b>ETORM.205/16</b>	32	5/16	14
<b>ETORM.203/8</b>	32	3/8	14

For Tri-wing head screws



NF ISO 1173, ISO 1173

⇒	L [mm]	Screw Size[mm]	ΔΔ [g]
<b>ETRI.101</b>	25	1	5,50
<b>ETRI.102</b>	25	2	5,50
<b>ETRI.103</b>	25	3	5,50
<b>ETRI.104</b>	25	4	5,50
<b>ETRI.105</b>	25	5	5,50

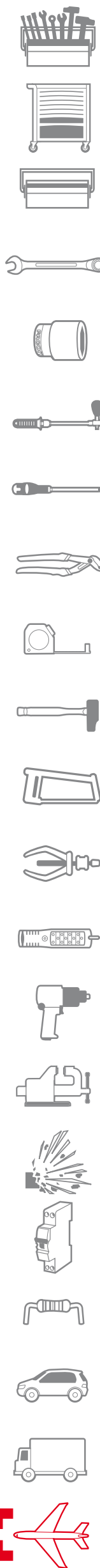

## Locking-wire pliers

### FACOM LOCKING-WIRE PLIERS

**Fast twist in lock-wire securing assemblies subject to vibration.**

- For stainless and inconel wire  $\varnothing$  1 mm.
- Side wire cutter.
- Slim nose-tip for optimum manoeuvrability.
- 10" model: 3 turns, 125 mm travel.
- 8" model: 2.5 turns, 95 mm travel.

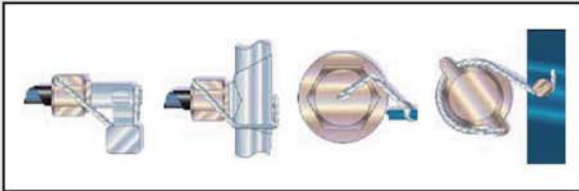

#### Automatic model

- Automatic-reset model for simplicity and time-saving.

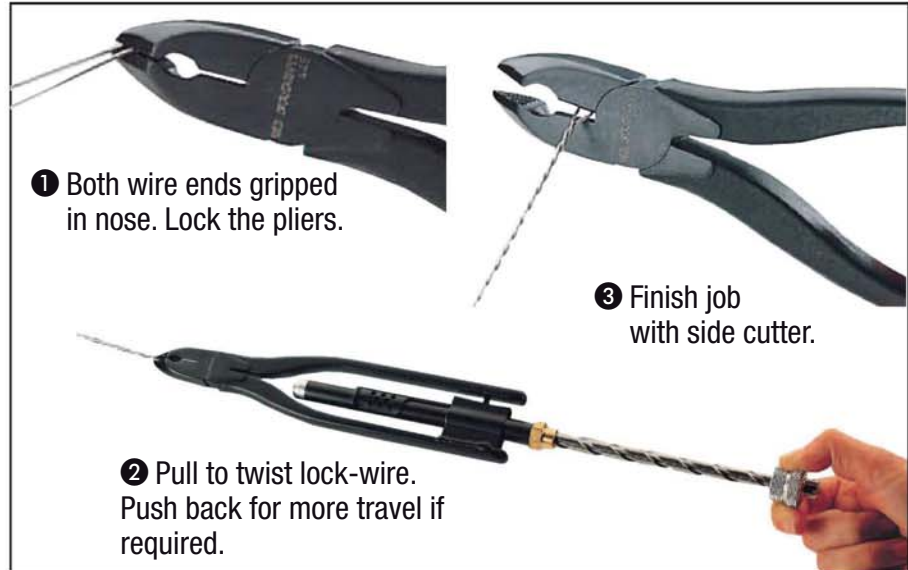

#### 8" short locking-wire pliers

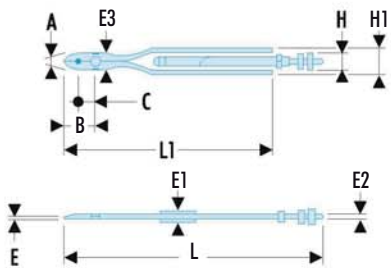

#### ASME B107.500

- "automatic" model.

	A [mm]	E [mm]	B [mm]	C [mm]	E1 [mm]	E2 [mm]	H [mm]	L [mm]	L2 [mm]	$\Delta\Delta$ [g]
<b>445.8R</b>	3	2,5	20	7	15	10,5	22	215	215	245

#### 10" locking-wire pliers

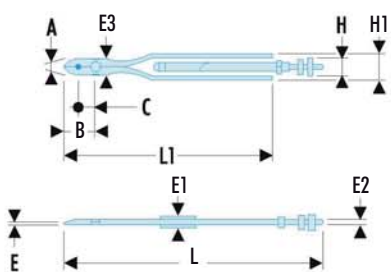

#### ASME B107.500

- "automatic" model.

	A [mm]	E [mm]	B [mm]	C [mm]	E1 [mm]	E2 [mm]	H [mm]	L [mm]	L2 [mm]	$\Delta\Delta$ [g]
<b>445.10R</b>	3	2,5	30	11	15,5	11,5	25	360	360	400

# SAFETY

# FOAM MODULES

## FACOM CONTROL SYSTEM

### SAFETY FIRST

- A separate space for each tool prevents them being left in sensitive areas.

### PRODUCTIVITY

- Tools quickly located and immediately returned after use. Avoiding loss.

### SPEED

- Missing tools identified "at a glance".



- Two-coloured modular system of foam tool trays designed to resist a wide range of hydrocarbons, hydraulic fluids and cleaning products.
  - Modules compatible with JET.XL and CHRONO.XL roller cabinets.
- Dimensions: 420 x 190 x 55 mm.



➤ Find the complete range of foam modules in the roller cabinets and workshop furniture section p. 52.



## CU.AE50 153-piece engine mechanics set

- Set designed for full workshop overhaul and occasional interventions between overhauls on the main heavy jets using SNECMA, GE, PW or RR motors:
  - Airbus A3xx, Boeing 7xx, Mc Donnell Douglas DCxx.
- 153 tools.
- Weight: 17.800 kg.



Code	Qtys	Set Description
<b>RB.40AU</b>	10	Sockets 3/16" to 9/16"
<b>R.240A</b>	1	1/4" universal joint
<b>R.232</b>	1	Coupler 1/4" - 3/8"
<b>R.236A</b>	1	Short-reach spinner handle
<b>R.215</b>	1	1/4" extension 150 mm long
<b>R.210</b>	1	1/4" extension 100 mm long
<b>R.155A</b>	1	1/4" metal-grip "palm-control" ratchet
<b>JL.40U</b>	10	"Junior" long-reach sockets 1/2" to 9/16"
<b>J.F</b>	7	Hinged sockets 1/2" - 11/16" - 3/4" - 3/8" - 5/8" - 7/16" - 9/16"
<b>JB.41AU</b>	5	Sockets 5/8" to 7/8"
<b>JB.40AU</b>	6	Sockets 1/4" to 9/16"
<b>J.240A</b>	1	3/8" universal joint
<b>J.230</b>	1	Coupler 3/8" - 1/4"
<b>J.215</b>	1	"Junior" extension 250 mm
<b>J.210</b>	1	"Junior" extension 125 mm
<b>J.155A</b>	1	3/8" metal-grip "palm-control" ratchet
<b>J.145</b>	1	Metal-grip hinged handle
<b>J.120A</b>	1	Sliding tee
<b>J.115</b>	1	Metal-grip speed brace
<b>CLE.MDAM100A</b>	6	Second cut locksmiths files
<b>ARZ.5,5</b>	1	Round blade offset screwdriver
<b>APZ.A</b>	1	Dual-size offset screwdriver
<b>APZ.B</b>	1	Dual-size offset screwdriver
<b>ANP</b>	2	Stubby screwdrivers Phillips® heads 1x35 mm and 2x35 mm
<b>AWP</b>	4	Phillips® screwdrivers PH 1x100 - 2x125 - 3x150 - 4x200
<b>AW</b>	4	Forged hexagonal blade screwdrivers for slotted heads 4x100 - 5,5x150 - 6,5x150 - 8x200 mm
<b>AN6.5X35</b>	1	Stubby screwdriver for slotted heads
<b>AN</b>	3	Round blade screwdrivers for slotted heads 2,5x75 - 3,5x75 - 4x100 mm

Code	Qtys	Set Description
<b>86H.JU7</b>	7	Folding set of hexagon keys 1/16" to 1/4"
<b>86H.JU6</b>	6	Folding set of hexagon keys 5/32" to 3/8"
<b>834.R2</b>	1	Inspection mirror 55 mm
<b>803.300M</b>	1	Flexible stainless 2-sided rule
<b>64.3/8X7/16</b>	1	12-point ring wrench
<b>55A.JU10</b>	10	Offset ring wrenches 1/4" to 1 1/4"
<b>445.10R</b>	1	Locking-wire pliers
<b>410.S</b>	1	Connector pliers
<b>440.JU17T</b>	17	1/4" to 1 1/4" combination wrench wallet set
<b>192.16CPE</b>	1	"Piano wire" diagonal cutters
<b>256.2,5</b>	1	Precision centre punch
<b>251A.JS9</b>	9	Precision sleeved drift punches 1 to 6 mm
<b>208A.40CBA</b>	1	Heavyweight series adaptable tip mallet
<b>195.20CPE</b>	1	Sheathed angled half-round nose pliers
<b>193.16CPE</b>	1	Sheathed straight half-round nose "telephone" pliers
<b>189.17CPE</b>	1	Sheathed round-nose pliers
<b>187.18CPE</b>	1	Sheathed universal pliers
<b>1830.1</b>	1	Extra-soft silk brush
<b>181A.25CPE</b>	1	Locking twin slip-joint multigrip pliers
<b>804</b>	1	19 blade feeler gauge
<b>603F</b>	1	Hacksaw frame
<b>234</b>	1	Scriber
<b>231</b>	1	Three-square scraper
<b>34</b>	6	Midget open-end wrenches 1/4" - 11/32" - 3/8" - 5/16" - 7/16" - 9/32"
<b>CKS.91</b>	1	Socket rack set
<b>JB.11/32</b>	1	Sockets 11/32"
<b>200C.26</b>	1	Graphite handle riveting hammer
<b>200C.30</b>	1	Graphite handle riveting hammer

**JETGXL.UAE50 CU.AE50 set supplied in foam modules and JET.8GM3S**

- Engine mechanics selection CU.AE50 supplied in foam modules in roller cabinet JET.8GM3S.



**CU.AE51 115-piece electricians set**

- For minor and major workshop overhaul and interventions on electrical equipment: control harnesses, power supply circuits, connections and relays, lighting, audiovisual.
- 115 tools.
- Weight: 6.880 kg.



Code	Qtys	Set Description
R.EL	5	Long 6 point sockets 1/4" - 5/16" - 3/8" - 7/16" - 1/2"
RB.40AU	10	Sockets 3/16" to 9/16"
R.240A	1	1/4" universal joint
R.236A	1	Short-reach spinner handle
R.216	1	Flexible socket extension 150 mm long
R.215	1	1/4" extension 150 mm long
R.210	1	1/4" extension 100 mm long
R.151	1	1/4" ratchet
R.120A	1	Sliding tee
AS.6L160T2A	6	Needle file wallet set
ARZ.5,5	1	Round blade offset screwdriver
APZ.B	1	Dual-size offset screwdriver
AWP	2	Screwdriver for Phillips® heads PH 1x100 - 2x125
ANPOX75	1	Screwdriver for Phillips® heads PH 0
AN	2	Screwdrivers for slotted heads 2,5x75 and 3,5x75 mm
AW	4	Screwdrivers for slotted head 4x100 - 5,5x150 - 6,5x150 - 8x200 mm
85.JU10	10	Wallet set of hexagon keys 33 to 183 mm
841A.4	1	"Stubby" scissors
840.1	1	Electricians knife with wire stripper
839A.0	1	Desoldering pump
834.R1	1	Inspection mirror 36 mm
826.1	1	Mechanical retriever
82H.JU10	10	Wallet set of hexagonal keys 1/16" to 3/8"
445.8R	1	Locking-wire pliers
410.S	1	Connector pliers
405.15	1	Precision diagonal cutters, axial cut
34.JU13T	13	Roll set of open end wrenches 3/16" to 11/16"

Code	Qtys	Set Description
256.2,5	1	Precision centre punch
251A.JT9	9	Precision sleeved drift punches 1 to 6 mm
208A.32CBA	1	Plastic-tip mallet
200H.26	1	Graphite handle riveting hammer
193.16CPE	1	Short half-round nose plier
189.17CPE	1	Sheathed round-nose pliers
188.16CPE	1	Sheathed flat-nose pliers
1230.30	1	Extra-soft silk brush
183.20CPE	1	Sheathed angled half-round nose pliers
180.CPE	1	Multigrip pliers
BV.21-10	1	Soldering iron stand
113A.8C	1	10" adjustable wrench
1830.1	1	Extra-soft silk brush
836	1	Pen light
804	1	19 blade feeler gauge
803.300M	1	Flexible stainless 2-sided rule
234	1	Scriber
163	1	Wire stripper and cutter
144	1	Ultra-flat straight tweezers
R.235	5	1/4" drive bit holder
ES.148T	1	1/4" bit for slotted head 8 mm
ES.136,5T	1	1/4" bit for slotted head 6,5 mm
ES.134T	1	1/4" bit for slotted head 4 mm
EP.102T	1	1/4" bit for Phillips® head n°2
EP.101T	1	1/4" bit for Phillips® head n°1
APB.1X40	1	Stubby screwdriver for Phillips® head n°1

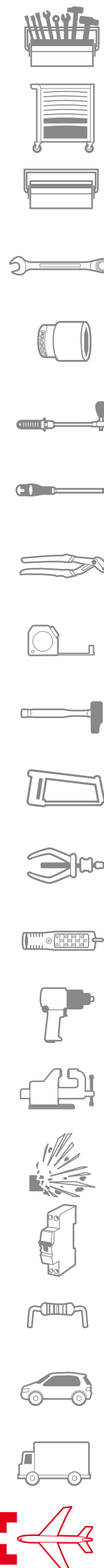

## CU.AE52 86-piece flight instruments set

- For workshop revisions and interventions on panel instruments, electric, electromechanical and electronic modules, on lamps and indicators.
- 86 tools.
- Weight: 3.490 kg.

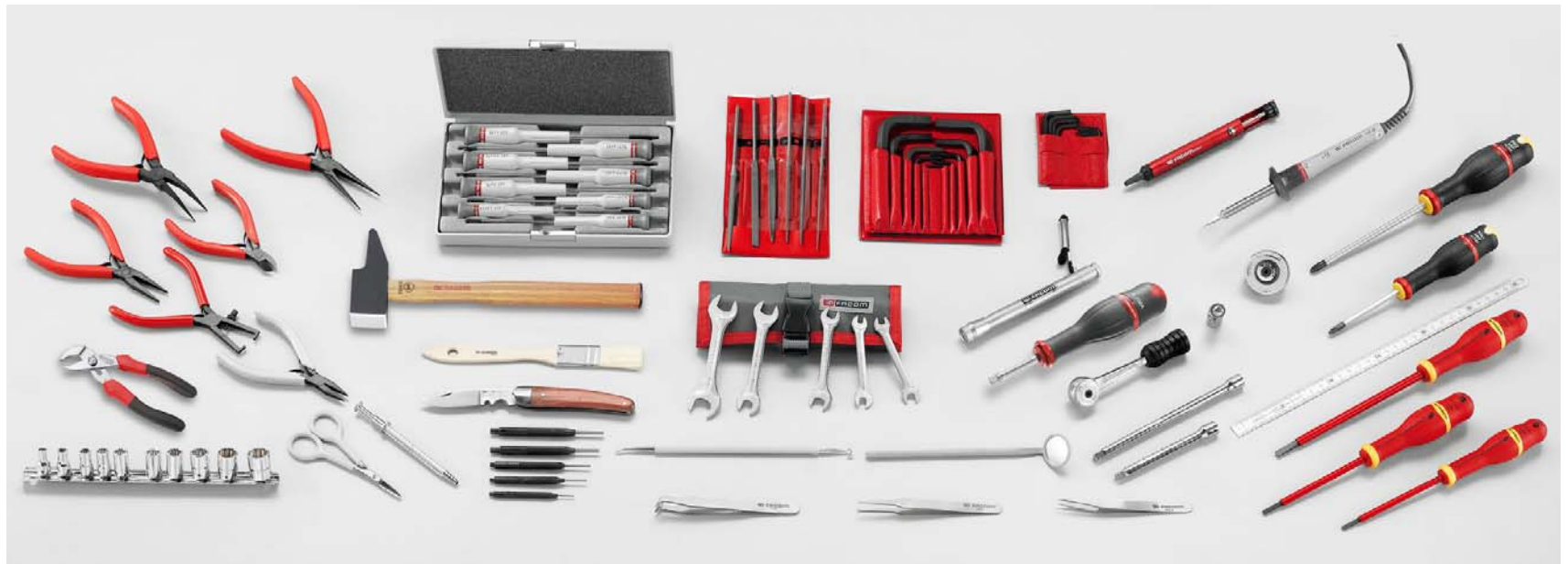

Code	Qty	Set Description
<b>RB.40AU</b>	10	Sockets 3/16" to 9/16"
<b>R.240A</b>	1	1/4" universal joint
<b>R.236A</b>	1	Short-reach spinner handle
<b>R.215</b>	1	1/4" extension 150 mm long
<b>R.210</b>	1	1/4" extension 100 mm long
<b>R.151</b>	1	1/4" ratchet
<b>R.150A</b>	1	Finger-control ratchet
<b>AVE</b>	3	Screwdrivers for slotted heads 3,5x100 - 4x100 - 5,5x150 mm
<b>AS.6L160T2A</b>	6	Needle file wallet set
<b>AEF.J3</b>	8	"Micro-Tech"® screwdrivers with case
<b>AWP</b>	2	Screwdriver for Phillips® PH heads 1x100 - 2x125
<b>85.JU10</b>	10	Wallet set of hexagon keys 33 to 183 mm
<b>841.1</b>	1	Very short pointed scissors
<b>840.1</b>	1	Electricians knife with wire stripper
<b>839A.0</b>	1	Desoldering pump
<b>835A</b>	1	Spring hook
<b>826.0</b>	1	Mechanical retriever
<b>82H.JU10</b>	10	Wallet set of hexagonal keys 1/16" to 3/8"

Code	Qty	Set Description
<b>803.300M</b>	1	Flexible stainless 2-sided rule
<b>405.10</b>	1	"Electronics" coaxial cutting pliers
<b>251A</b>	5	Drift punches 1 - 1.5 - 2 - 2.5 - 3 mm
<b>200H.26</b>	1	Graphite handle riveting hammer
<b>22.JU5T</b>	5	Roll set of miniature open-end wrenches 3/16" to 9/16"
<b>194.12</b>	1	Fine wire strippers
<b>1830.1</b>	1	Extra-soft silk brush
<b>176A.CPY</b>	1	Sheathed multigrip pliers
<b>142.2</b>	1	15° angle-nose tweezers
<b>1230.30</b>	1	Soldering iron 30W
<b>836</b>	1	Pen light
<b>834</b>	1	Inspection mirror
<b>431.MT</b>	1	Micro-Tec® narrow short-nose pliers
<b>421</b>	1	"Electronics" short sheathed flat-nose pliers
<b>403</b>	1	"Electronics" sheathed half round-nosed pliers
<b>402</b>	1	Sheathed half-round nose pliers
<b>144</b>	1	Ultra-flat straight tweezers
<b>139</b>	1	End-cutting tweezers



**CU.AE53 145-piece cell maintenance set**

- For overhaul and interventions on the cell: control surfaces, flap cylinders, structure of heavy carrier aircraft.
- 145 tools.
- Weight: 12.880 kg

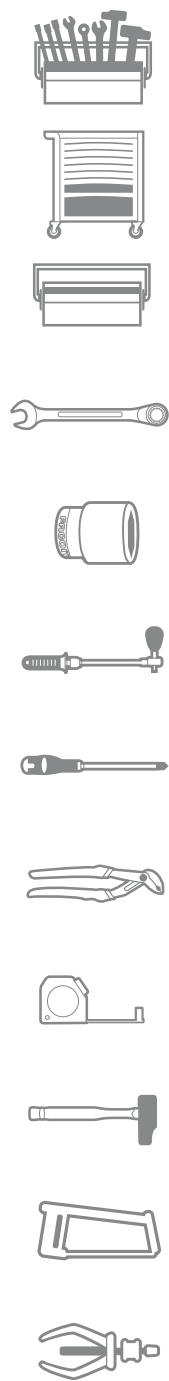
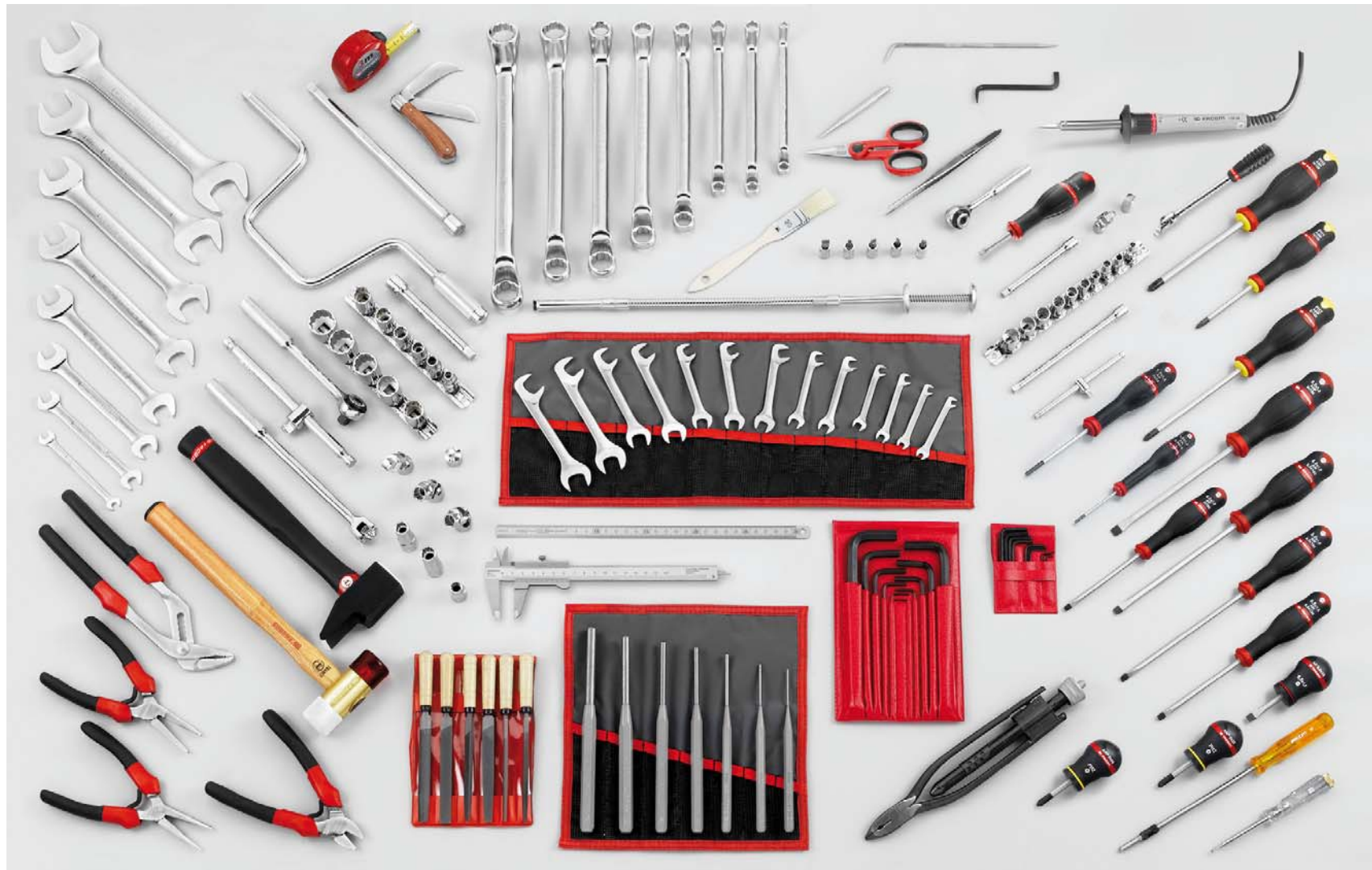

Code	Qtys	Set Description
<b>RB.40AU</b>	10	Sockets 3/16" to 9/16"
<b>R.240A</b>	1	1/4" universal joint
<b>R.232</b>	1	Coupler 1/4" - 3/8"
<b>R.236A</b>	1	Short-reach spinner handle
<b>R.235</b>	5	Bit-holder 1/4"
<b>R.215</b>	1	1/4" extension 150 mm long
<b>R.210</b>	1	1/4" extension 100 mm long
<b>R.155A</b>	1	1/4" metal-grip "palm-control" ratchet
<b>R.140A</b>	1	Drive-hinged handle 1/4"
<b>R.120A</b>	1	Sliding tee
<b>JB.41AU</b>	5	Sockets 5/8" to 7/8"
<b>JB.40AU</b>	6	Sockets 1/4" to 9/16"
<b>J.LA</b>	2	Long-reach sockets 7/16" and 3/8"
<b>J.F</b>	2	Hinged sockets 7/16" and 3/8"
<b>JB.11/32</b>	1	Sockets
<b>J.240A</b>	1	3/8" universal joint
<b>J.230</b>	1	Coupler 3/8" - 1/4"
<b>J.215</b>	1	"Junior" extension 250 mm
<b>J.210</b>	1	"Junior" extension 125 mm
<b>J.155A</b>	1	3/8" metal-grip "palm-control" ratchet
<b>J.145</b>	1	Metal-grip hinged handle
<b>J.120A</b>	1	Junior sliding tee
<b>J.115</b>	1	Metal-grip speed brace
<b>CLE.MDAM100A</b>	6	Second cut locksmiths files
<b>AV.HT2B</b>	1	110-250 V voltage tester screwdriver
<b>ARZ.5,5</b>	1	Dual-size offset screwdriver
<b>AFU.1</b>	1	Screw starter slotted heads
<b>AN</b>	2	Stubby screwdriver for Phillips® heads 2,5x75 and 3x75 mm
<b>AWP</b>	3	Screwdrivers for Phillips® heads 1x100 - 2x125 - 3x150
<b>AW</b>	4	Screwdrivers for slotted heads 4x100 - 5,5x100 - 6,5x150 - 8x200 mm
<b>AN6,5X35</b>	1	Stubby screwdriver for slotted heads 6,5x35 mm
<b>ANPOX75</b>	1	Screwdrivers for Phillips® heads PH 0

Code	Qtys	Set Description
<b>APB</b>	1	Short blade screwdriver Phillips® 1x40 - 2x 40
<b>85.JU10</b>	10	Wallet set of hexagon keys 33 to 183 mm
<b>83H.JU10</b>	10	Wallet set of long-reach hexagonal keys 1/16" to 3/8"
<b>826.1</b>	1	Mechanical retriever
<b>805.1</b>	1	Vernier caliper to 1/10 mm
<b>803.300M</b>	1	Flexible stainless 2-sided rule
<b>55A.JU8</b>	8	Ring wrenches 1/4" to 15/16"
<b>445.10R</b>	1	Locking-wire pliers
<b>44.JU8</b>	8	Inch combination wrenches 1/4" to 1 1/4"
<b>192.16CPE</b>	1	"Piano wire" diagonal cutters
<b>193.16CPE</b>	1	Sheathed straight half-round nose "telephone" pliers
<b>188.16CPE</b>	1	Sheathed flat-nose pliers
<b>180.CPE</b>	1	Multigrip pliers
<b>BV.21-10</b>	1	Soldering iron stand
<b>1230-30</b>	1	Soldering iron (20/40W)
<b>893.46</b>	1	Case tape measure 2m
<b>843</b>	1	Twin-blade electricians knife
<b>841</b>	1	Electricians scissors
<b>234</b>	1	Scriber
<b>150</b>	1	Standard straight tweezers
<b>34.JU13T</b>	13	Roll set of open-end wrenches 3/16" to 11/16"
<b>256.2,5</b>	1	Precision centre punch
<b>248.JT7</b>	7	Long drift punches
<b>208A.32CBA</b>	1	Plastic-tip mallet
<b>200H.28</b>	1	Graphite handle riveting hammer
<b>1830.1</b>	1	Extra-soft silk brush
<b>ES.148T</b>	1	Bits for slotted heads 8 mm
<b>ES.136,5T</b>	1	Bits for slotted heads 6,5 mm
<b>ES.134T</b>	1	Bits for slotted heads 4 mm
<b>EP.102T</b>	1	Bits for Phillips heads n°2
<b>EP.101T</b>	1	Bits for Phillips heads n°1
<b>ACL.1A</b>	1	Ratchet bit-driver





## CU.AE54 128-piece equipment maintenance set

- For interventions and fittings in the cockpit of airline and cargo aircraft: lighting, interior fixtures, seats, air conditioning circuits.
- 128 tools
- Weight: 8.680 kg.



Code	Qtys	Set Description
<b>39.JU14T</b>	14	Short combination wrenches 1/8" to 11/16"
<b>44</b>	4	Open-end wrenches: 1/2 x 9/16 - 3/4 x 13/16 - 5/8 x 11/16 - 7/8 x 1 5/16
<b>34.JU13T</b>	13	Roll set of open-end wrenches 3/16" to 11/16"
<b>64</b>	3	12-point ratchet ring wrenches: 1/4 x 5/16 - 3/8 x 7/16 - 1/2 x 9/16
<b>R.120A</b>	1	Sliding tee
<b>R.210</b>	1	100 mm extension
<b>R.215</b>	1	150 mm extension
<b>R.240A</b>	1	1/4" universal joint
<b>R.232</b>	1	Coupler 1/4" - 3/8"
<b>J.210</b>	1	"Junior" extension 125 mm
<b>J.215</b>	1	"Junior" extension 250 mm
<b>J.240A</b>	1	3/8" universal joint
<b>J.120A</b>	1	Junior sliding tee
<b>J.230</b>	1	Coupler 3/8" - 1/4"
<b>J.LA</b>	2	Junior long-reach sockets 3/8" and 7/16"
<b>AW</b>	3	Screwdrivers for slotted heads 4x100 - 5.5x150 - 6.5x150
<b>AN</b>	2	Screwdrivers for slotted head 2.5x75 and 3.5x75 mm
<b>AN4X35</b>	1	Stubby screwdriver 4 x 35
<b>ANPOX75</b>	1	Screwdriver for Phillips® PH head 0
<b>AWP2X125</b>	3	Screwdriver for Phillips® PH head 2
<b>ANP</b>	2	Screwdrivers 1 x 35 and 2 x 35 mm
<b>APZ.B</b>	1	Offset screwdriver
<b>A3,5X100VE</b>	1	1000 V insulated screwdriver for slotted head 3.5 x 100 mm
<b>ARZ.5,5</b>	1	Dual-size offset screwdriver
<b>82H.JU10</b>	10	Wallet set of hexagonal keys 1/16" to 3/8"
<b>192.16CPE</b>	1	"Piano wire" diagonal cutters
<b>R.155A</b>	1	1/4" metal grip "palm control" ratchet

Code	Qtys	Set Description
<b>J.155A</b>	1	3/8" metal grip "palm control" ratchet
<b>R.140A</b>	1	Drive-hinged handle 1/4"
<b>J.145</b>	1	Metal-grip hinged handle
<b>J.115</b>	1	Metal-grip speed brace
<b>RB.40AU</b>	10	Sockets 3/16" to 9/16"
<b>JB.41AU</b>	5	Sockets 5/8" to 7/8"
<b>JB.40AU</b>	6	Sockets 1/4" to 9/16"
<b>85.JU10</b>	10	Wallet set of hexagonal keys 33 to 183 mm
<b>188.16CPE</b>	1	Sheathed flat-nose pliers
<b>193.16CPE</b>	1	Sheathed straight half-round nose "telephone" pliers
<b>405.12</b>	1	Precision diagonal cutters
<b>1230.30</b>	1	Dual-rating soldering iron (20/40W)
<b>BV.21-10</b>	1	Soldering iron stand
<b>839A.0</b>	1	Desoldering pump
<b>841A.4</b>	1	Bi-material electricians scissors
<b>843</b>	1	Twin-blade electricians knife
<b>248</b>	3	Long drift punches 2 - 3 - 4 mm
<b>256.2,5</b>	1	Precision centre punch
<b>234</b>	1	Scriber
<b>803.300M</b>	1	Flexible stainless rule 300 mm
<b>836</b>	1	Pen light
<b>410.S</b>	1	Connector pliers
<b>445.8R</b>	1	Locking-wire pliers
<b>200H.26</b>	1	Graphite handle riveting hammer
<b>JB.11/32</b>	1	Sockets
<b>841A.4</b>	1	Electrician scissors
<b>176A.CPY</b>	1	Multigrip plier

## CU.AE56 167-piece stop-over mechanics set

- For interventions on motor, cell accessories, electrical equipment and circuits.

- 167 tools.

Weight: 16.960 kg.

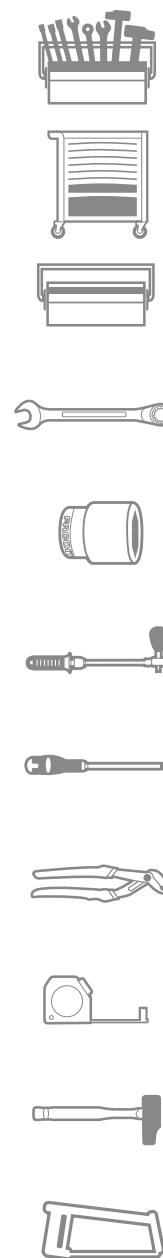
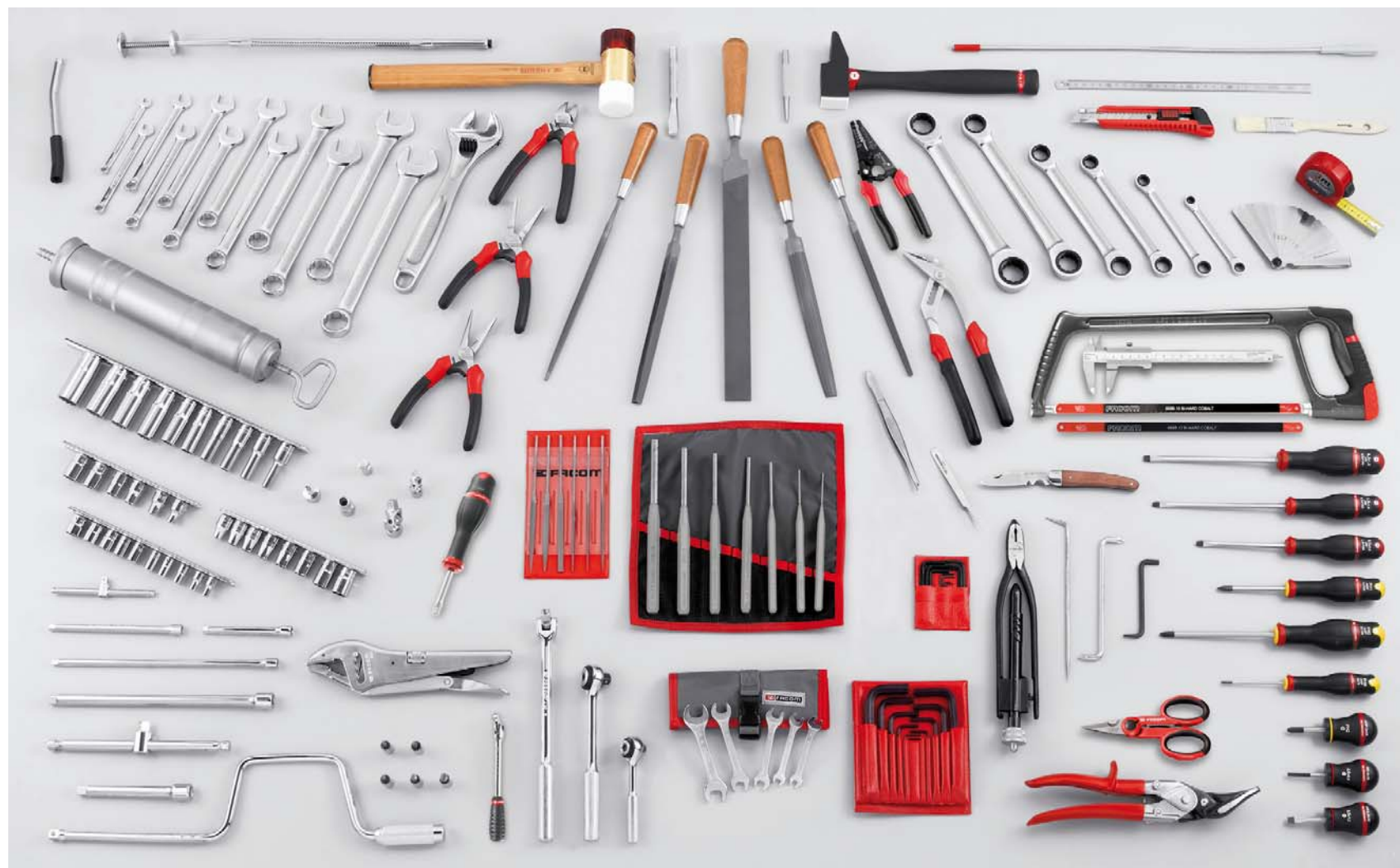

Code	Qtys	Set Description
STG	5	File set
RB.40AU	10	Sockets 3/16" to 9/16"
R.240A	1	1/4" universal joint
R.232	1	Coupler 1/4" - 3/8"
R.236A	1	Short-reach spinner handle
R.235	5	Bit holder 1/4"
R.217	1	1/4" extension 250 mm long
R.215	1	1/4" extension 150 mm long
R.210	1	1/4" extension 100 mm long
R.155A	1	1/4" metal-grip "palm control" ratchet
R.140A	1	Drive-hinged handle 1/4"
R.120A	1	Sliding tee
JL.40U	10	Junior long-reach sockets 1/2" to 9/16"
JB.41AU	5	Sockets 5/8" to 7/8"
JB.40AU	6	Sockets 1/4" to 9/16"
J.240A	1	3/8" universal joint
J.230	1	Coupler 3/8" - 1/4"
J.215	1	"Junior" extension 250 mm
J.210	1	"Junior" extension 125 mm
J.155A	1	3/8" metal-grip "palm control" ratchet
J.145	1	Metal-grip hinged handle
J.120A	1	"Junior" sliding tee
J.115	1	Metal-grip speed brace
AS.6L160T2A	6	Needle file wallet set
ARZ.5,5	1	Round blade offset screwdriver
APZ.B	1	Dual-size offset screwdriver
ANP1X35	1	Stubby screwdriver for Phillips® heads 1
AWP	2	Screwdriver for Phillips® PH heads 1-2
ANPOX75	1	Screwdriver for Phillips® heads 0
AW	3	Screwdrivers for slotted head 4x100 - 5.5x150 and 6.5x150 mm
AN	4	Stubby screwdrivers 4x35 - 6.5x3 - 2x75 - 3x75 mm
882A	1	Scroll shears
85.JU10	10	Wallet set of hexagonal keys 33 to 183 mm
884.S18	1	18 mm snap-off blade cutter
841A.4	1	Bi-material electricians scissors

Code	Qtys	Set Description
840.1	1	Electricians knife with wire stripper
827.1	1	Extra-slim magnetic retrievers
826.1	1	Mechanical retriever
82H.JU10	10	Wallet set of hexagonal keys 1/16" to 3/8"
805.1	1	Vernier caliper to 1/10 mm
803.300M	1	Flexible stainless 2-sided rule
64	6	Ring wrenches: 1/2x9/16" - 1/4x5/16" - 3/4x13/16" - 3/8x7/16" - 5/8x11/16" - 7/8x15/16"
668B.12	10	Pack of ten 12 teeth/cm bimetal blades
445.10R	1	Locking-wire pliers
440.JU12	12	Combination wrenches 1/4" to 15/16"
192.16CPE	1	"Piano wire" diagonal cutters
256.4	1	4 mm precision centre punch
263.G19	1	Chisel
248.JT7	7	Long drift punches 2 to 10 mm
22.JU5T	5	Roll set of miniature open-end wrenches 3/16" to 9/16"
208A.40CBA	1	Heavyweight series adaptable tip mallet
200H.32	1	Graphite handle riveting hammer
193.16CPE	1	Sheathed straight half-round nose "telephone" pliers
188.16CPE	1	Sheathed flat-nose pliers
1830.1	1	Extra-soft silk brush
180.CPE	1	Multigrip plier
142.1	1	Straight-shouldered tweezers
113A.10C	1	10" adjustable wrench
893.316	1	Case tape measure 3m
804	1	19 blade feeler gauge
603F	1	Hacksaw frame
500	1	Lock-grip pliers
376A	1	Manual oil syringe
234	1	Scriber
163	1	Wire cutter and stripper
154	1	Straight tweezers
JB.11/32	1	Sockets
ES.T	5	Bits 101 - 102 - 134 - 136,5 - 148



## ▣ JETGXL.UAE56 CU.AE56 set supplied in foam modules and JET.8GM3S

- CU.AE56 stopover mechanics set supplied in foam modules and JET.8GM3S



## ▣ CU.AE57 127-piece major check set

- For periodical major checks on engines, trains, cells, hydraulic systems of wide-bodied aircraft: Airbus, Boeing, Mc Donnell Douglas.
- 127 tools.
- Weight: 14.430 kg.

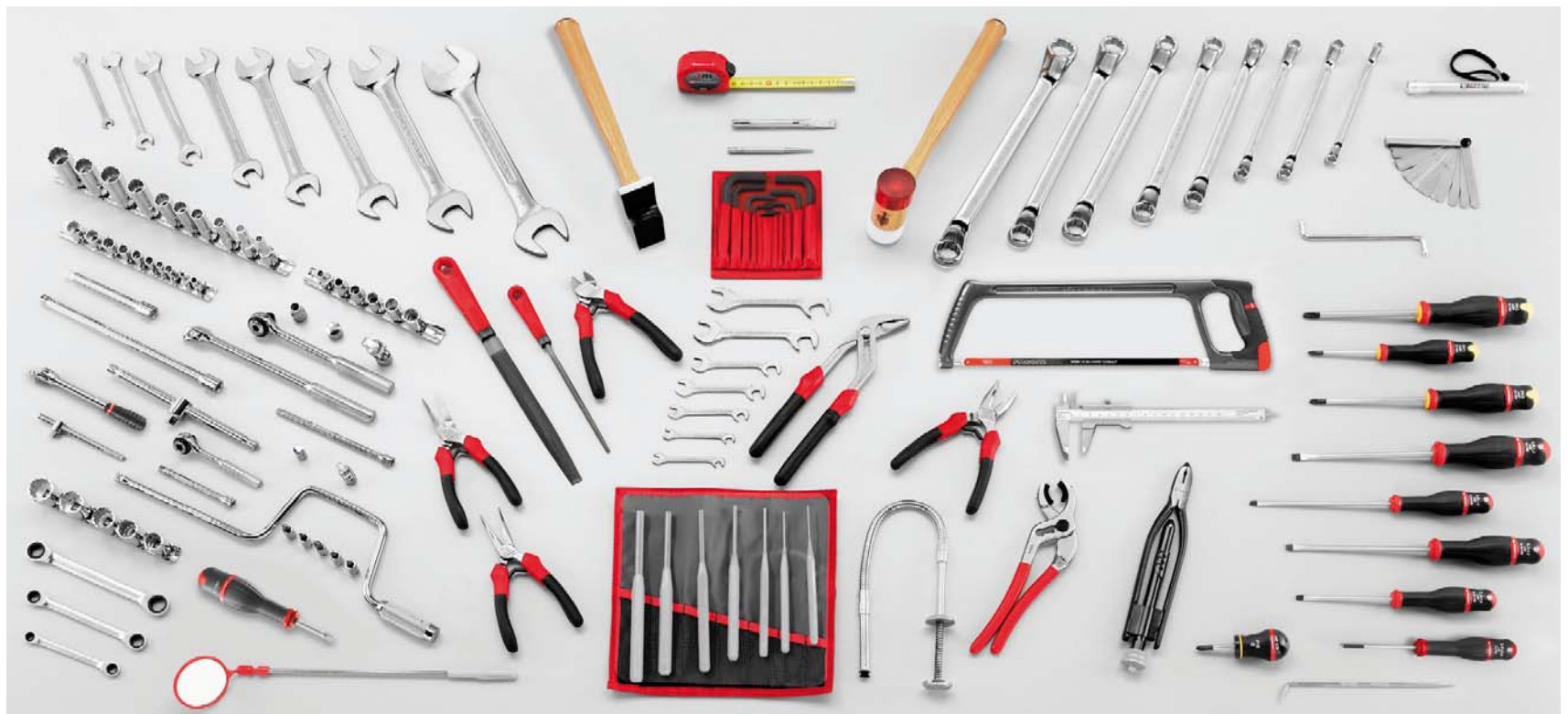

🔧	Qtys	Set Description
<b>RB.40AU</b>	10	Sockets 3/16" to 9/16"
<b>R.155A</b>	1	"Radio" metal-grip ratchet
<b>R.140A</b>	1	Drive-hinged handle 1/4"
<b>R.120A</b>	1	Sliding tee
<b>R.236A</b>	1	Short-reach spinner handle
<b>R.240A</b>	1	1/4" universal joint
<b>R.210</b>	1	100 mm extension
<b>R.215</b>	1	150 mm extension
<b>R.232</b>	1	Coupler 1/4" - 3/8"
<b>JB.41AU</b>	5	Sockets 5/8" to 7/8"
<b>JB.40AU</b>	6	Sockets 1/4" to 9/16"
<b>JL.40U</b>	10	"Junior" long-reach sockets 1/4" to 13/16"
<b>J.155A</b>	1	"Junior" metal-grip ratchet
<b>J.115</b>	1	Metal-grip speed brace
<b>J.145</b>	1	Metal-grip hinged handle
<b>J.120A</b>	1	"Junior" sliding tee
<b>J.210</b>	1	"Junior" extension 125 mm
<b>J.215</b>	1	"Junior" extension 250 mm
<b>J.240A</b>	1	3/8" universal joint
<b>J.230</b>	1	Coupler 3/8" - 1/4"
<b>44.JU8</b>	8	Open-end wrenches 1/4" to 1" 1/4
<b>34</b>	7	Open end wrenches 1/4" - 11/16" - 3/8" - 5/16" - 5/8" - 7/16" - 9/32"
<b>55A.JU8</b>	8	Ring wrenches 1/2x9/16" to 7/8x15/16"
<b>64</b>	3	Ring wrenches: 1/2x9/16" - 1/4x5/16" - 3/8x7/16"
<b>82H.JU10</b>	10	Wallet set of hexagonal keys 1/16" to 3/8"
<b>AWP</b>	3	Screwdriver for Phillips® heads 1-2-3
<b>AW</b>	4	Screwdrivers for slotted heads 4x100 - 5.5x150 - 6.5x150 - 8x200 mm

🔧	Qtys	Set Description
<b>AN3X75</b>	1	Screwdriver for slotted heads 3x75 mm
<b>APZ.B</b>	1	Offset screwdriver for Phillips® heads
<b>180.CPE</b>	1	Multigrip pliers
<b>188.16CPE</b>	1	Sheathed flat-nose pliers
<b>193.16CPE</b>	1	Sheathed straight half-round nose "telephone" pliers
<b>187.16CPE</b>	1	Sheathed universal pliers
<b>192.16CPE</b>	1	"Piano wire" diagonal cutters
<b>410.S</b>	1	Connector pliers
<b>445.10R</b>	1	Locking-wire pliers
<b>805.1</b>	1	Vernier caliper to 1/10 mm
<b>804</b>	1	19 blade feeler gauge
<b>234</b>	1	Scriber
<b>893.316</b>	1	Case tape measure 3m
<b>200H.32</b>	1	Graphite handle riveting hammer
<b>208A.40CBA</b>	1	Heavyweight series adaptable tip mallet
<b>248.JT7</b>	7	Long drift punches 2 to 10 mm
<b>256.2,5</b>	1	Precision centre punch
<b>263.619</b>	1	Chisel
<b>826.1</b>	1	Mechanical retriever
<b>834.R2</b>	1	Articulated mirror
<b>836</b>	1	Pen light
<b>DRD.MD200EMA</b>	1	Half-round second-cut file 200 mm
<b>RD.MD150EMA</b>	1	Half-round second-cut file 150 mm
<b>603F</b>	1	Hacksaw frame
<b>JB.11/32</b>	1	Sockets
<b>APB.2X40</b>	1	Short blade screwdriver Phillips® 2x40
<b>ES.T</b>	3	Bits 134 - 136,5 - 148
<b>EPT</b>	2	Bits 101 - 102
<b>R.235</b>	5	Bit-holder 1/4"

**CU.AE10 118-piece engine cell set**

- 118 tools.
- Weight: 11.920 kg.



Code	Qtys	Set Description
<b>RB.40AU</b>	10	Sockets 3/16" to 9/16"
<b>R.155A</b>	1	"Radio" metal-grip ratchet
<b>R.140A</b>	1	Drive-hinged handle 1/4"
<b>R.120A</b>	1	Sliding tee
<b>R.210</b>	1	100 mm extension
<b>R.215</b>	1	150 mm extension
<b>R.240A</b>	1	1/4" universal joint
<b>R.232</b>	1	Coupler 1/4" - 3/8"
<b>JB.41AU</b>	5	Sockets 5/8" to 7/8"
<b>JB.40AU</b>	6	Sockets 1/4" to 9/16"
<b>JB.11/32</b>	1	Sockets
<b>J.155A</b>	1	"Junior" metal-grip ratchet
<b>J.145</b>	1	Metal-grip hinged handle
<b>J.115</b>	1	Metal-grip speed brace
<b>J.120A</b>	1	"Junior" sliding tee
<b>J.210</b>	1	"Junior" extension 125 mm
<b>J.215</b>	1	"Junior" extension 250 mm
<b>J.240A</b>	1	3/8" universal joint
<b>J.230</b>	1	Coupler 3/8" - 1/4"
<b>JL.40U</b>	10	"Junior" long-reach sockets 1/2" to 9/16"
<b>440.JU17T</b>	17	1/4" to 1 1/4" combination wrench wallet set
<b>34.JU13T</b>	13	Roll set of open-end wrenches 3/16" to 1 1/16"
<b>87H.JU8</b>	8	Short hexagonal key ring-set

Code	Qtys	Set Description
<b>AN5,5X35</b>	1	Stubby screwdriver for slotted heads 5,5x35 mm
<b>AWP</b>	2	Screwdriver for Phillips® heads PH 1x100 - 2x125
<b>AW</b>	4	Screwdrivers for slotted head 4x100 - 5,5x100 - 6,5x150 - 8x200 mm
<b>AN3X75</b>	1	Screwdriver for slotted heads 3 x 75 mm
<b>180.CPE</b>	1	Multigrip plier
<b>188.20CPE</b>	1	Sheathed flat-nose pliers
<b>193.16CPE</b>	1	Sheathed straight half-round nose "telephone" pliers
<b>192.16CPE</b>	1	"Piano wire" diagonal cutters
<b>445.10R</b>	1	Locking-wire pliers
<b>803.300M</b>	1	Flexible stainless 2-sided rule
<b>804</b>	1	19 blade feeler gauge
<b>805.1</b>	1	Vernier caliper to 1/10 mm
<b>200H.28</b>	1	Graphite handle riveting hammer
<b>208A.32CBA</b>	1	Plastic-tip mallet
<b>256.2,5</b>	1	Precision centre punch
<b>248.JT7</b>	7	Long drift punches 2 to 10 mm
<b>234</b>	1	Scriber
<b>834.R1</b>	1	Articulated mirror
<b>827.1</b>	1	Magnetic retriever
<b>836</b>	1	Pen light
<b>APB.2X40</b>	1	Short blade screwdriver Phillips® 2x40
<b>ANPOX75</b>	1	Screwdriver Phillips® n°0
<b>ACL.1A</b>	1	Ratchet bit-driver 1/4"



## CM.AE22 115-piece maintenance mechanics set

- 115 tools.
- Weight: 13.750 kg.



Code	Qtys	Set Description
<b>440.JE14</b>	14	Combination wrenches 7 to 24 mm
<b>55A.JE8</b>	8	Ring wrenches 8 to 26 mm
<b>113A.10C</b>	1	10" adjustable wrench
<b>R.120A</b>	1	Sliding tee
<b>R.236A</b>	1	Short-reach spinner handle 155 mm
<b>R.210</b>	1	1/4" extension 100 mm long
<b>R.215</b>	1	1/4" extension 150 mm long
<b>R.240A</b>	1	1/4" universal joint
<b>R.232</b>	1	Coupler 1/4" - 3/8"
<b>R.155A</b>	1	"Radio" metal-grip ratchet
<b>R.140A</b>	1	Drive-hinged handle 1/4"
<b>RB.40AE</b>	10	"Radio" sockets 5.5 to 14 mm
<b>J.155A</b>	1	"Junior" metal-grip ratchet
<b>J.145</b>	1	Metal-grip hinged handle
<b>J.115</b>	1	Metal-grip speed brace
<b>J.120A</b>	1	Sliding tee
<b>J.210</b>	1	3/8" extension 125 mm long
<b>J.215</b>	1	3/8" extension 250 mm long
<b>J.240A</b>	1	3/8" universal joint
<b>J.230</b>	1	Coupler 3/8" - 1/4"
<b>JB.40AE</b>	8	"Junior" sockets 7 to 14 mm
<b>JB.41AE</b>	6	"Junior" sockets 15 to 21 mm
<b>AN3X75</b>	1	Screwdriver for slotted head 3x75 mm
<b>AWH</b>	4	Screwdrivers for slotted heads 6,5x150 - 8x175 mm
<b>AN</b>	2	Screwdrivers for slotted heads 4x100 - 6,5x125 mm
<b>ANP</b>	1	Short blade screwdrivers Phillips® PH 1x100 - 2x125 - 3x150mm

Code	Qtys	Set Description
<b>AFU.1</b>	1	Screw starter for slotted heads
<b>AFUX.1</b>	1	Screw starter for cross-heads
<b>AKZ.6</b>	1	Offset screwdriver for slotted heads
<b>APZ.B</b>	1	Offset screwdriver for Phillips® heads
<b>82.JL10</b>	10	Hexagon keys
<b>180.CPE</b>	1	Multigrip pliers
<b>188.16CPE</b>	1	Sheathed flat-nose pliers
<b>193.16CPE</b>	1	Sheathed straight half-round nose "telephone" pliers
<b>192.16CPE</b>	1	"Piano wire" diagonal cutters
<b>187.16CPE</b>	1	Sheathed universal pliers
<b>507A</b>	1	Compact lock-grip pliers
<b>985.ST</b>	1	Shears
<b>603F</b>	1	Hacksaw frame
<b>CLE.MDAM100A</b>	6	Second cut locksmiths files
<b>200H.28</b>	1	Graphite handle riveting hammer
<b>208A.32CBA</b>	1	Plastic-tip mallets
<b>256.2,5</b>	1	Precision centre punch
<b>262A</b>	2	Forged chisels 15 and 18 mm
<b>234</b>	1	Scriber
<b>893.316</b>	1	Case tape measure 3m
<b>803.300M</b>	1	Stainless 2-sided rule
<b>804</b>	1	19 blade feeler gauge
<b>836</b>	1	Pen light
<b>410.S</b>	1	Connector pliers
<b>445.10R</b>	1	Locking-wire pliers

## CM.AE21 97-piece instruments electrician set

- For servicing and interventions on electric controls, flight instruments, optical and firing equipment (fighters, bombers...).
- 97 tools.
- Weight: 6.940 kg.



Code	Qtys	Set Description
<b>39.JE16T</b>	16	Roll set of combination wrenches 3.2 to 17 mm
<b>34</b>	6	Open-end wrenches 3.2 - 4 - 5 - 5.5 - 6 - 7 mm
<b>R.120A</b>	1	Sliding tee
<b>R.236A</b>	1	Short-reach spinner handle
<b>R.210</b>	1	100 mm extension
<b>R.215</b>	1	150 mm extension
<b>R.240A</b>	1	1/4" universal joint
<b>R.140A</b>	1	Drive-hinged handle 1/4"
<b>AN</b>	4	Screwdrivers for slotted heads 2,5x75 - 3x75 - 4x100 - 5,5x125 mm
<b>AN4X35</b>	1	Stubby screwdriver for slotted head 4x35 mm
<b>ANP</b>	2	Screwdriver for Phillips® head PH 0x75 - 1x25 - 1x100 - 2x125 mm
<b>AWH6,5X150</b>	1	Screwdrivers for slotted heads 6,5x150 mm
<b>ARZ.4</b>	1	Round blade offset screwdriver 4 mm
<b>APZ.A</b>	1	Dual-size offset screwdriver for Phillips® heads
<b>82.JL10</b>	10	Hexagon keys
<b>193.16CPE</b>	1	Sheathed straight half-round nose "telephone" pliers
<b>181.18CPE</b>	1	Locking twin slip-joint multigrip pliers
<b>405.12</b>	1	Precision diagonal cutters
<b>431.MT</b>	1	Short-nose pliers
<b>401</b>	1	Flat-nose pliers

Code	Qtys	Set Description
<b>402</b>	1	Sheathed half-round nose pliers
<b>403</b>	1	"Electronics" sheathed half-round nose pliers
<b>1230.30</b>	1	Soldering iron 30W
<b>BV.21-10</b>	1	Soldering iron stand
<b>200H.26</b>	1	Graphite handle riveting hammer
<b>839A.0</b>	1	Desoldering pump
<b>841A.4</b>	1	Bi-material electricians scissors
<b>840.1</b>	1	Electricians knife with wire stripper
<b>AS.6L160T2A</b>	6	Needle file wallet set
<b>803.300M</b>	1	Flexible stainless 2-sided rule
<b>804</b>	1	19 blade feeler gauge
<b>AEF.J3</b>	8	"Micro-Tech®" screwdrivers with case
<b>149</b>	1	Straight tweezers
<b>R.155A</b>	1	"Radio" metal-grip ratchet
<b>RB.40AE</b>	10	"Radio" sockets 5.5 to 14 mm
<b>834.R1</b>	1	Articulated mirror
<b>826.0</b>	1	Mechanical retriever
<b>836</b>	1	Pen light
<b>1830.1</b>	1	Extra-soft silk brush
<b>445.8R</b>	1	Locking-wire pliers

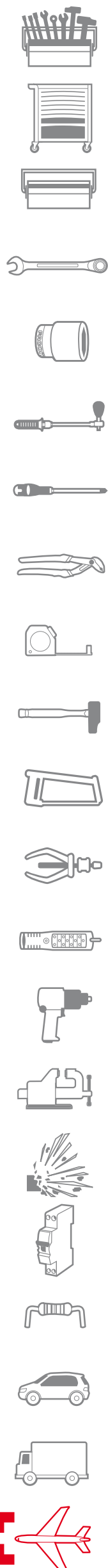

# IDEMCO

**W : [www.idemcosb.com.my](http://www.idemcosb.com.my)**  
**E : [idemco@idemcosb.com.my](mailto:idemco@idemcosb.com.my)**  
**T : +6 03-7781 7973**