



ELECTRONIC PLIERS

816



Micro-Tech® series electronic pliers..... **816**

ANTISTATIC SERIES ELECTRONIC PLIERS

827



ESD antistatic series electronic pliers..... **827**

MICRO-TECH®

833



Micro-Tech® screwdrivers..... **833**
 Bits series 0 - 4 mm drive..... **835**
 Sets of Micro-Tech® screwdrivers..... **836**
 Micro-Tech® set..... **838**
 Clockwork screwdriver sets..... **840**

TWEEZERS

841



Standard series tweezers..... **841**
 PVC sheath series tweezers..... **842**
 High precision series tweezers..... **842**
 Special tweezers **844**
 Sets of tweezers..... **844**

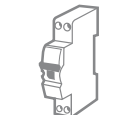
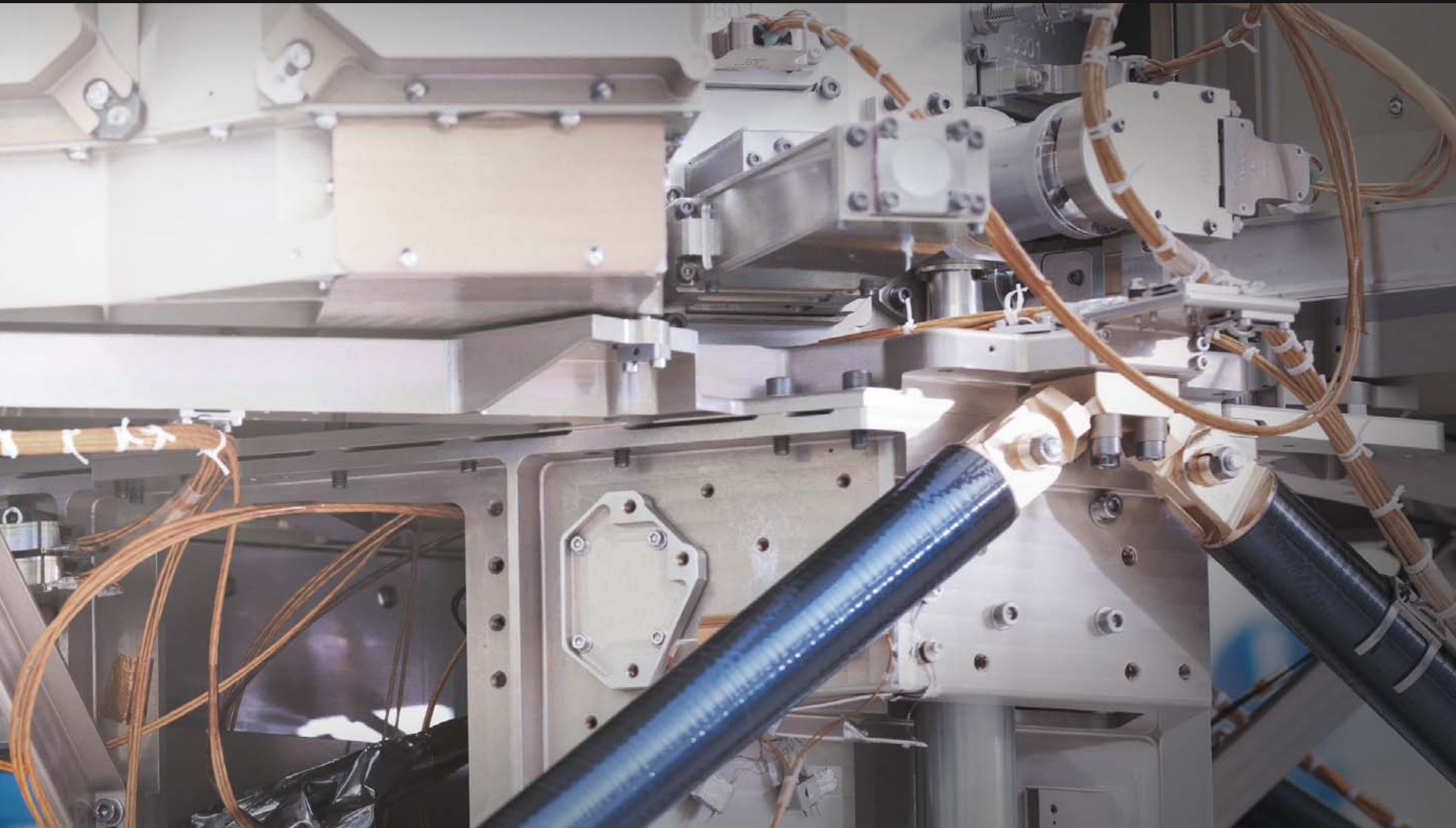

SPECIAL MICRO-TECH®

845



Circlip® pliers..... 845
Truarc® pliers..... 845

MISCELLANEOUS TOOLS

845



Scissors..... 845
Utility knife 846
Hacksaw frame..... 846
Miscellaneous tools 846

SOLDERING

852



Heat-regulated welders 852
Electronic soldering irons..... 853
"Instant" soldering irons 854
High power soldering irons 854
Gas soldering iron 855
Welding accessories 855

MICRO-TECH® CHOOSING MICRO-PLIERS

1 Materials to cut

TYPE OF MATERIALS	WIRES	Mechanical strength in N/mm ²	HARDNESS (Hrc)
Copper, Nickel, Aluminium	Soft	220	-
Iron nail or wire, pin	Semi-soft	800	22
Iron spring, cable, hard steel wire or nail	Hard	1675	50
Steel spring	Piano wire	2200	59

2 Dimension and type of wire or component to cut (diameter or thickness)

- Cross-section, thickness.
- Semi-soft: copper/Alu alloy.
- Hard wire: soft steel (30Hrc).
- Piano wire: steel spring (50Hrc).

3 Access:

- Bullet, pointed, angled, end nose for components.

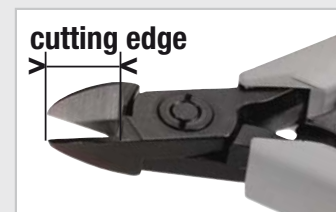

Flat half-round nose. 4 Cutting edge design and type of cut







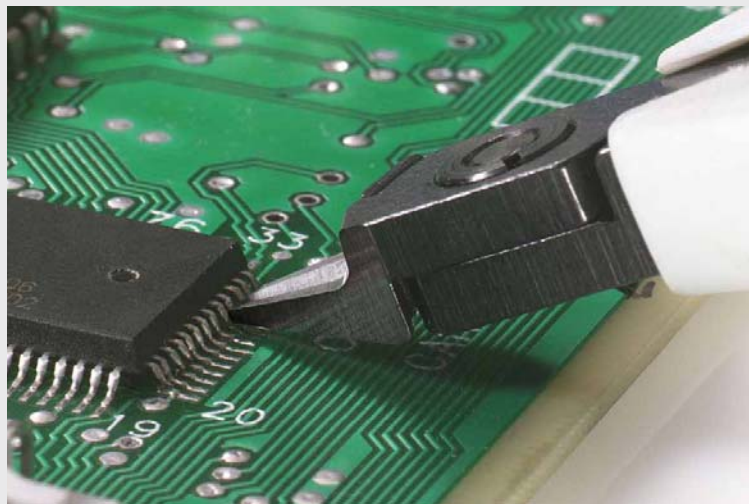

- **Axial cut:** cutting edges are treated to achieve maximum strength and precision cutting of a wide range of materials, from piano wire to copper.
- **Semi-flush cut:** suitable for semi-hard wire.
- **Flush cut:** the most precise shape in matters of cuts, but also the most fragile, designed to cut soft materials such as copper.

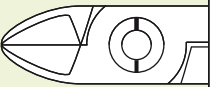
CUTTING EDGES	PATTERN	FEATURES	WIRE TYPE		OPERATION	APPLICATION
AXIAL CUT		Cutting edges are treated to achieve maximum strength and precision cutting of a wide range of materials, from piano wire to copper.	Cu	✓	– Production work – Day-to-day use – Maintenance – Hard materials	– Customer service (hi-fi) – Machine-tools – Automotive – Domestic appliances
			CuNi alloy	✓		
			Mild steel 30 HRC	✓		
			Hard steel 50 HRC Piano wire	✓		
SEMI-FLUSH CUT		Micro-chamfered cutting edges ensure high cutting capacity with clean finish. Precision is maintained throughout a long service life even in intensive use. Suitable for semi-hard wire.	Cu	✓	– Clean cut in intensive use – Wiring – Batch electronics – Semi-hard materials	– Computers – Telephone exchanges – Video and laser – Micro-Tech® (hi-fi, labs)
			CuNi alloy	✓		
			Mild steel 30 HRC	✓		
			Hard steel 50 HRC Piano wire	✗		
FLUSH CUT		This range is designed to give a through-cut without crushing the wire. Clean-cut ends allow reliable soldering, without damage to electronic components from arcing. Suitable for soft wire only.	Cu	✓	– High-frequency apparatus – High precision equipment – Cut-back before soldering – Electrostatically sensitive components	– Defence – Aerospace – Aviation – Laboratory
			CuNi alloy	✓		
			Mild steel 30 HRC	✗		
			Hard steel 50 HRC Piano wire	✗		

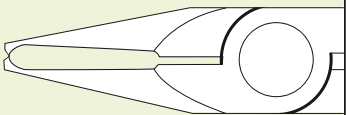
MICRO-TECH®

CHOOSING MICRO-PLIERS

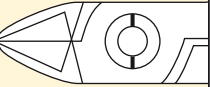
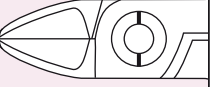

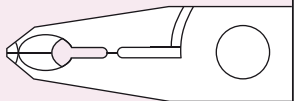
NOSE DESIGN		Ø Cu WIRE (mm)	Ø MAX Fe WIRE 30 HRc	Ø MAX PIANO WIRE
		0 0.5 1 1.5 2		
Bullet nose: for strength 	405.8 MT-E 405.MT-E 405.10 MT-E 405.12MT-E 405-E 405.10 RMT-RE 405.12 RMT-RE*	0.2 → 1.0 0.3 → 1.3 0.3 → 1.4 0.4 → 2.0 0.3 → 1.1 0.3 → 1.2 0.4 → 1.5	0.5 0.7 0.8 1.0 0.7 0.8 1.0	 0.4 0.5 0.8 0.4 0.5 0.6
End nose for reach 	408.MT	0.4 → 1.5	0.5	
Bullet nose: for strength 	406.8-MT-E 406.MT-E 435.MT-E 436.MT-E 415.MT-E 406.RMT-RE* 435.RMT-RE* 415.RMT*-RE*	0.1 → 1.0 0.1 → 1.3 0.1 → 1.3 0.1 → 1.2 0.3 → 2.0 0.1 → 1.1 0.1 → 1.1 0.3 → 1.5	 0.7 0.7 0.7 1.0 0.7 0.7 0.8	
Pointed nose: for control 	416.MT-E 416.PMT-E 416.12 MT-E 416.RMT	0.1 → 1.0 0.1 → 0.8 0.3 → 1.6 0.1 → 0.9	0.5 0.4 0.7 0.5	
Bullet nose: for strength 	407.8 MT-E 407.MT-E 425.MT-E 426.MT-E	0.1 → 0.8 0.1 → 1.3 0.1 → 1.3 0.1 → 1.2		
Pointed nose: for control	417.PMT-E	0.1 → 0.8		
Angled nose for accuracy 	427.MT-E 429.MT-E 430.MT	0.2 > 0.6 0.2 → 1.0 0.2 → 1.0		
End nose for reach	418.MT 428.MT	0.1 -> 0.6 0.1 → 0.8		



Diagonal cutting pliers

BULLET NOSE PLIERS

- Are stronger than other profiles.
- Have a high cutting capacity and durability that are useful in a wide variety of applications.



AXIAL CUT
All applications,
all materials.

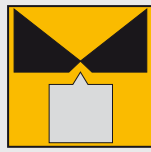

SEMI-FLUSH CUT
Clean, long-life cut in
semi-hard materials.

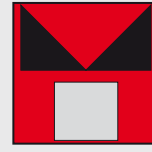

FLUSH CUT
Smooth cut for
sound soldered
connections.



Micro-Tech® «small mesh» cutters: thin

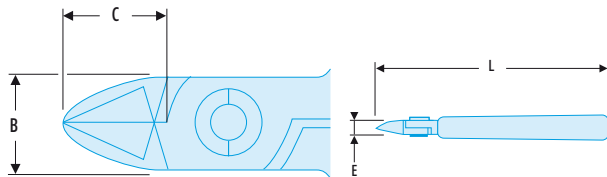

NF ISO 9654, ISO 9654, DIN ISO 9654, ASME B107.500

- These small mesh pliers are adapted to miniaturisation of electronic components.
- Weight: 60 g.

➤	B [mm]	C [mm]	E [mm]	L [mm]	Cut	Fe wire 30 HRc diameter [mm]	Cu - Ni wire diameter [mm]	Piano Diameter [mm]
405.8MT	8,5	9	6	110	∧	0,5	0,2 - 1	-
406.8MT	8,5	9	6	110	∧	-	0,1 - 1	-
407.8MT	8,5	9	6	110	∧	-	0,1 - 1	-

Micro-Tech® «compact» cutters: handling

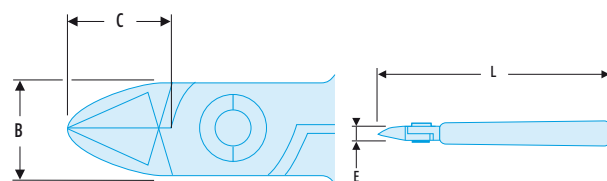

NF ISO 9654, ISO 9654, DIN ISO 9654, ASME B107.500

- These pliers combine cutting performance with handling thanks to their new slim diagonal shape.
 - Fall prevention models avoid wire ejection. The 405.MT pliers allow to cut piano wire up to 0.4 mm.
- Weight: 60 g.

➤	B [mm]	C [mm]	E [mm]	L [mm]	Offcut retainer	Cut	Fe wire 30 HRc diameter [mm]	Cu - Ni wire diameter [mm]	Piano Diameter [mm]
405.MT	10,5	9,5	7	110	-	∧	0,7	0,3 - 1,3	0,4
406.MT	10,5	9,5	7	110	-	∧	0,7	0,1 - 1,3	-
406.RMT	10,5	9,5	7	110	•	∧	0,6	0,1 - 1,1	-
407.MT	10,5	9,5	7	110	-	∧	-	0,1 - 1,3	-

Micro-Tech® «rugged» cutters: versatility

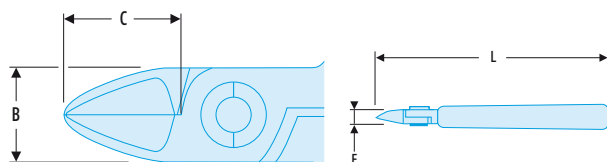

NF ISO 9654, ISO 9654, DIN ISO 9654, ASME B107.500

- These pliers allow neat cutting of multiple materials: from copper wire to piano wire up to 0.5 mm.
 - Fall prevention models avoid wire ejection.
- Weight: 60 g.

➤	B [mm]	C [mm]	E [mm]	L [mm]	Offcut retainer	Cut	Fe wire 30 HRc diameter [mm]	Cu - Ni wire diameter [mm]	Piano Diameter [mm]
405.10MT	10,5	11,5	7	110	-	∧	0,8	0,3 - 1,4	0,5
405.10RMT	10,5	11,5	7	110	•	∧	0,7	0,3 - 1,2	0,5

Micro-Tech® «long» cutters: access

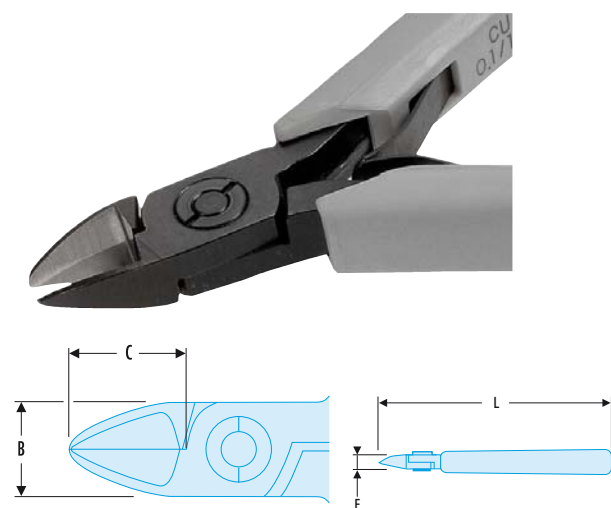

NF ISO 9654, ISO 9654, DIN ISO 9654, ASME B107.500

- These pliers allow to go further; up to + 1.5 to 2 mm compared with standard pliers.
 - Fall prevention models avoid wire ejection.
- Weight: 60 g.

➤	B [mm]	C [mm]	E [mm]	L [mm]	Cut	Fe wire 30 HRc diameter [mm]	Cu - Ni wire diameter [mm]
435.MT	10,5	13	7	110		0,7	0,1 - 1,3
425.MT	10,5	13	7	110		-	0,1 - 1,3

Micro-Tech® «long thin» cutters with clearance

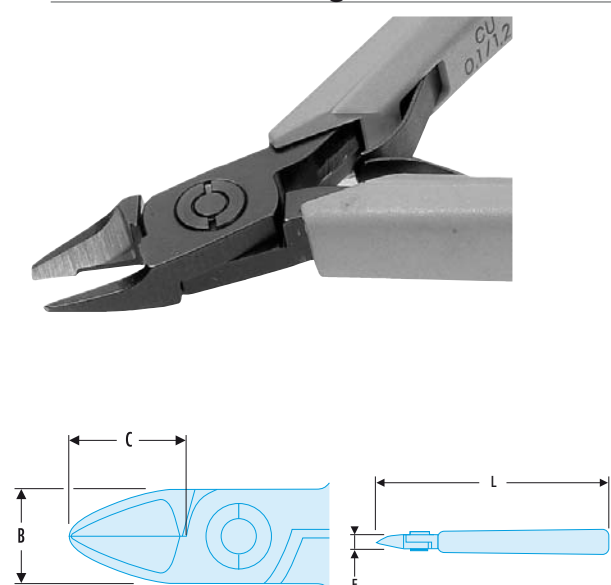

NF ISO 9654, ISO 9654, DIN ISO 9654, ASME B107.500

- These pliers allow to cut behind components and pass under obstacles (coils, resistors...).
- Weight: 60 g.

➤	B [mm]	C [mm]	E [mm]	L [mm]	L1 [mm]	Cut	Fe wire 30 HRc diameter [mm]	Cu - Ni wire diameter [mm]
426.MT	10,5	13	7	110	5,5		-	0,1 - 1,2

Micro-Tech® «high capacity» cutters: power

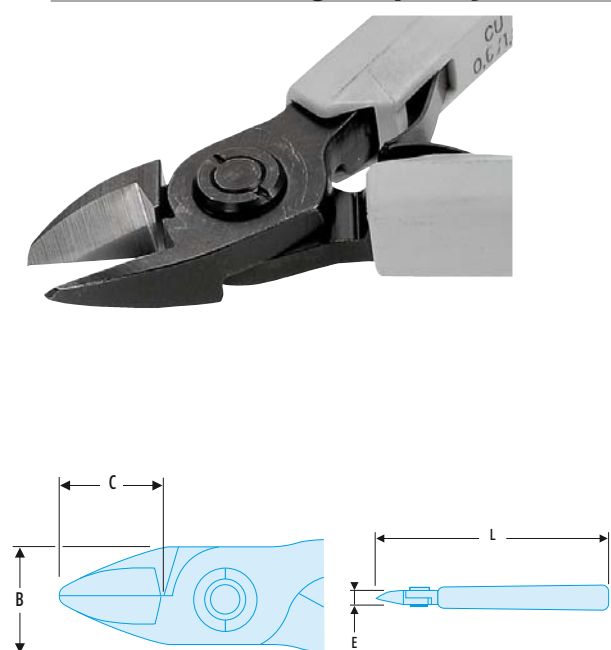

NF ISO 9654, ISO 9654, DIN ISO 9654, ASME B107.500

- These pliers are suited to major efforts and repetitive work over a broad range of materials.
 - Fall prevention models avoid wire ejection.
- Weight: 95 g.

➤	B [mm]	C [mm]	E [mm]	L [mm]	Cut	Fe wire 30 HRc diameter [mm]	Cu - Ni wire diameter [mm]	Piano Diameter [mm]
405.12MT	16	16	8	125		1,0	0,4 - 2,0	0,8
415.MT	16	16	8	125		0,9	0,3 - 2,0	-

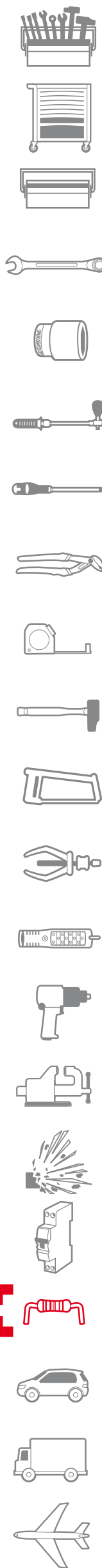

Slim nose cutting pliers

POINTED-NOSE PLIERS

• Are ideal where clearance is restricted and allow better visibility of the wire being cut.

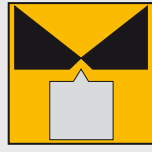

SEMI-FLUSH CUT

Clean, long-life cut in semi-hard materials.



FLUSH CUT

Smooth cut for sound soldered connections.

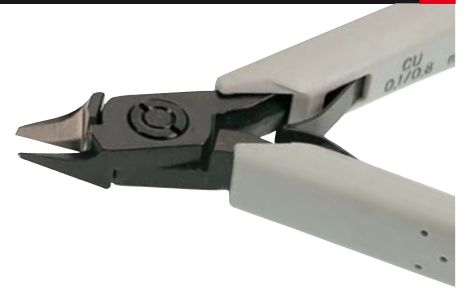

Micro-Tech® «machined» cutters

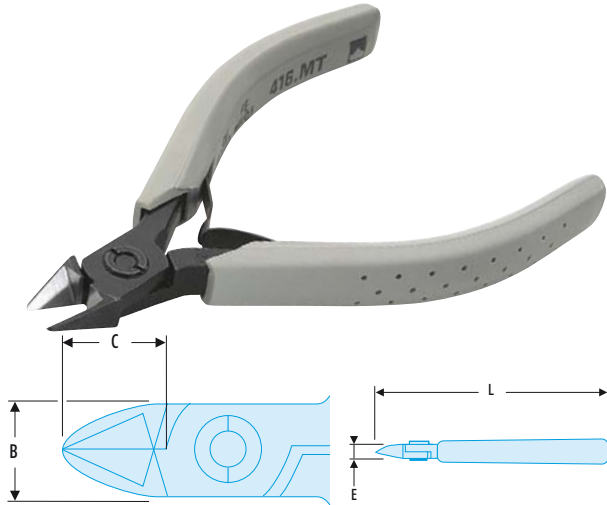

NF ISO 9654, ISO 9654, DIN ISO 9654, ASME B107.500

- Compact noses for difficult access.
 - Fall prevention models avoid wire ejection.
- Weight: 60 g.

⇒	B [mm]	C [mm]	E [mm]	L [mm]	Offcut retainer	Cut	Fe wire 30 HRc diameter [mm]	Cu - Ni wire diameter [mm]
416.MT	10,5	10,5	7	110	-		0,5	0,1 - 1,0
416.RMT	10,5	10,5	7	110	•		0,5	0,1 - 0,9

Micro-Tech® «thin nose tip» cutters: handling

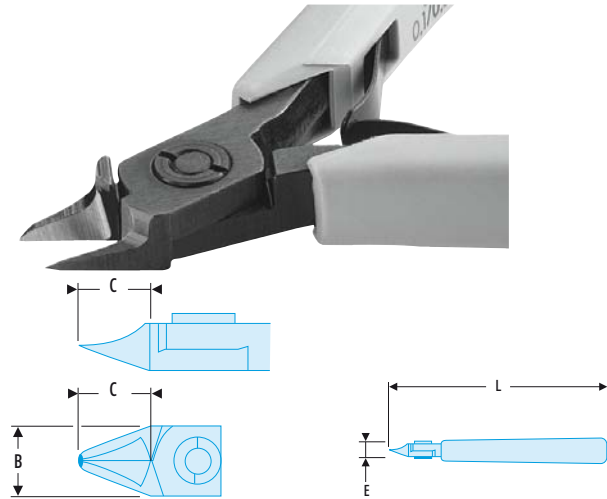

NF ISO 9654, ISO 9654, DIN ISO 9654, ASME B107.500

- These pliers pass under all obstacles of the PCB and provide better visibility.
- Weight: 60 g.

⇒	B [mm]	C [mm]	C1 [mm]	E [mm]	L [mm]	Cut	Fe wire 30 HRc diameter [mm]	Cu - Ni wire diameter [mm]
416.PMT	10,5	10,5	9,5	7	110		0,4	0,1 - 0,8
417.PMT	10,5	10,5	9,5	7	110		-	0,1 - 0,8

Micro-Tech® «high capacity machined» cutters

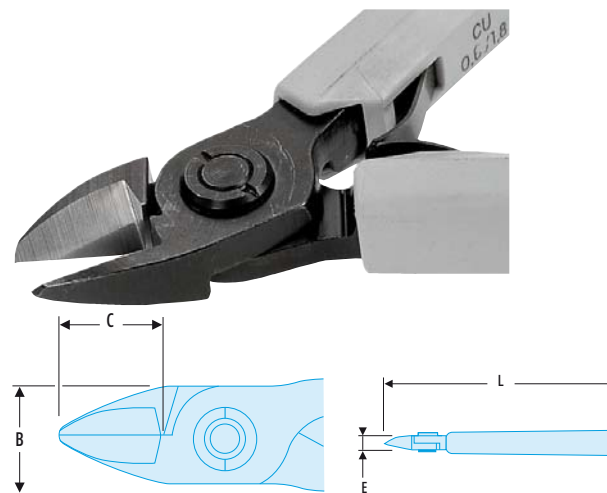

NF ISO 9654, ISO 9654, DIN ISO 9654, ASME B107.500

- Broadly dimensioned for large series works.
 - Semi-flush cutting.
- Weight: 95 g.

⇒	B [mm]	C [mm]	E [mm]	L [mm]	Fe wire 30 HRc diameter [mm]	Cu - Ni wire diameter [mm]
416.12MT	16	16	8	125	0,7	0,3 - 1,6

Angled nose cutting pliers

ANGLED-NOSE CUTTING PLIERS

- Ideal for use on printed circuits, electronic modules and hybrid circuits.
- Designed for cutting right up against the board in the smallest of spaces.
- Flush cutting edges.

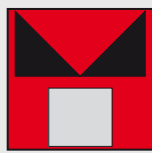

FLUSH CUT
Smooth cut for sound soldered connections.

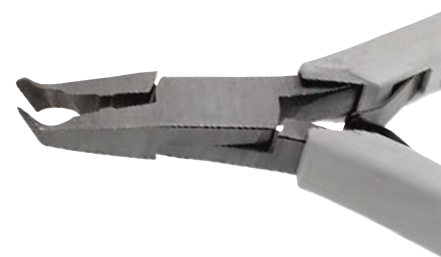

Micro-Tech® 30° nose cutters



NF ISO 9654, ISO 9654, DIN ISO 9654, ASME B107.500

- Cutting edges angled at 30° with rear clearance.
 - Cut: flush.
- Weight: 65 g.

➤	B [mm]	C [mm]	E [mm]	L [mm]	Cu - Ni wire diameter [mm]
427.MT	11	23	7	120	0,2 - 0,6

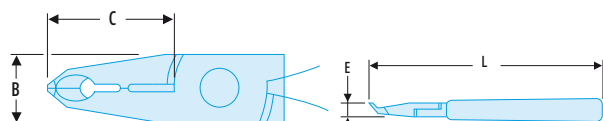

Micro-Tech® 70° nose cutters

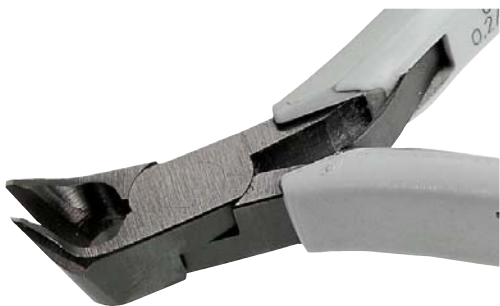

NF ISO 9654, ISO 9654, DIN ISO 9654, ASME B107.500

- Model with wide cutting edges angled at 70° broadly cleared.
 - Cut: flush.
- Weight: 60 g.

➤	B [mm]	C [mm]	E [mm]	L [mm]	Cu - Ni wire diameter [mm]
429.MT	11,5	12	7	110	0,2 - 1,0

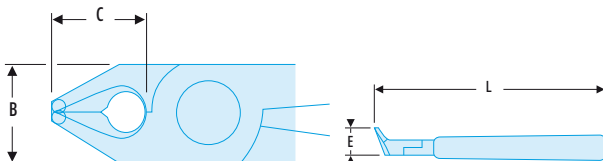

«End-tip» cutting pliers

Micro-Tech® «tip» cutters



NF ISO 9654, ISO 9654, DIN ISO 9654, ASME B107.500

- Long and narrow nose for vertical access cut.
 - Cut: flush.
- Weight: 75 g.

➤	B [mm]	C [mm]	E [mm]	L [mm]	Cu - Ni wire diameter [mm]
418.MT	10,5	21	2,7	120	0,1 - 0,6

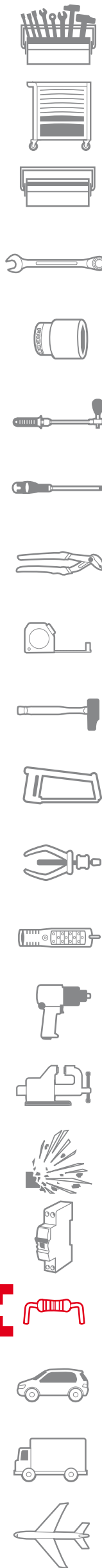
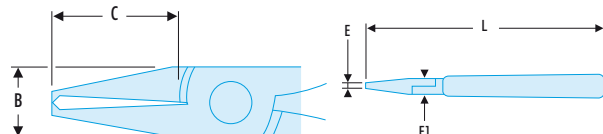

Cutting pliers for DIP-CMS components

Micro-Tech® diagonal cutter for DIP - CMS components

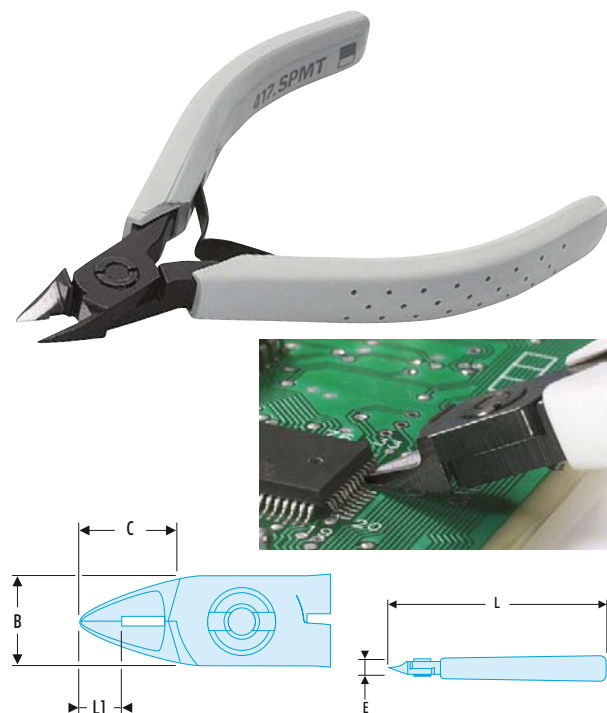

NF ISO 9654, ISO 9654, DIN ISO 9654, ASME B107.500

- These pliers provide access between two legs of "DIP" components with a 0.65 mm gap. As they are extremely thin, these pliers can be used only for this function.
 - Cut: flush.
- Weight: 60 g.

➤	B [mm]	C [mm]	E [mm]	L [mm]	L1 [mm]	Cu - Ni wire diameter [mm]
417.SPMT	10,5	10,5	7	110	6,5	0,1 - 0,6

Flat nose gripping pliers

FLAT-NOSE PLIERS

- These pliers serve all professional needs in laboratory, production and maintenance applications.
- The rectangular-section jaws are smooth with contoured inside edges to avoid damage to components.
- Matt black non-reflective finish.
- Leaf spring.



Micro-Tech® extra-long nose gripper pliers

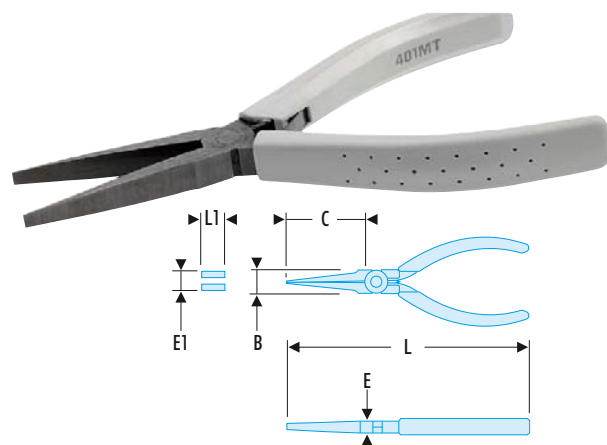

NF ISO 9655, ISO 9655, DIN ISO 9655, ASME B107.500

- For powerful loads.
- Weight: 80 g.

➤	B [mm]	C [mm]	E [mm]	E1 [mm]	L [mm]	L1 [mm]
401.MT	14	48	8	1	160	5

Micro-Tech® long and rigid nose grippers

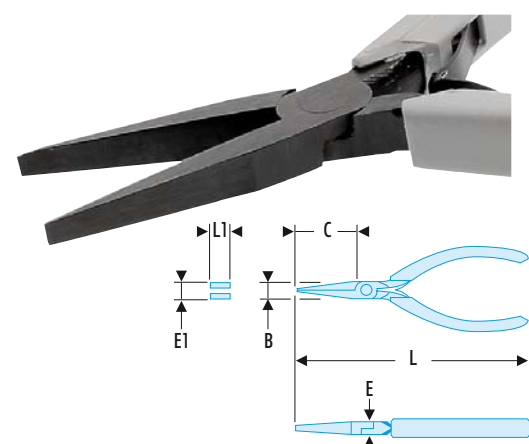

NF ISO 9655, ISO 9655, DIN ISO 9655, ASME B107.500

Weight: 70 g.

➤	B [mm]	C [mm]	E [mm]	E1 [mm]	L [mm]	L1 [mm]
421.MT	11	33	7	1	130	5

Micro-Tech® shaping gripper pliers

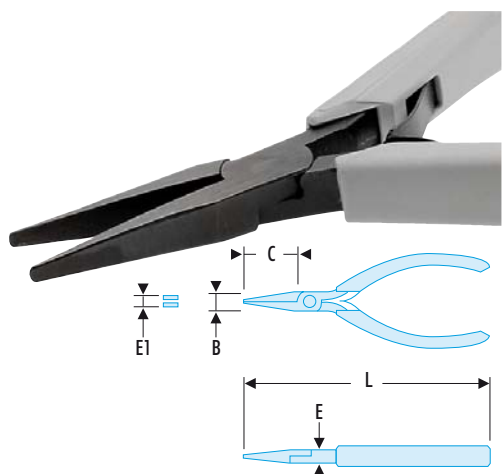

NF ISO 9655, ISO 9655, DIN ISO 9655, ASME B107.500

- Very thin nose.
- Weight: 60 g.

	B [mm]	C [mm]	E [mm]	E1 [mm]	L [mm]
420.MT	9	21	7	1	125

Micro-Tech® short nose gripper pliers

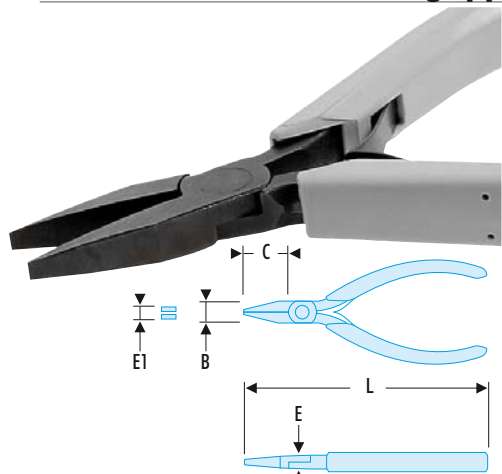

NF ISO 9655, ISO 9655, DIN ISO 9655, ASME B107.500

- Narrow mesh, for high precision works.
- Weight: 55 g.

	B [mm]	C [mm]	E [mm]	E1 [mm]	L [mm]
431.MT	9	20	6	1	135

Micro-Tech® thin nose grippers

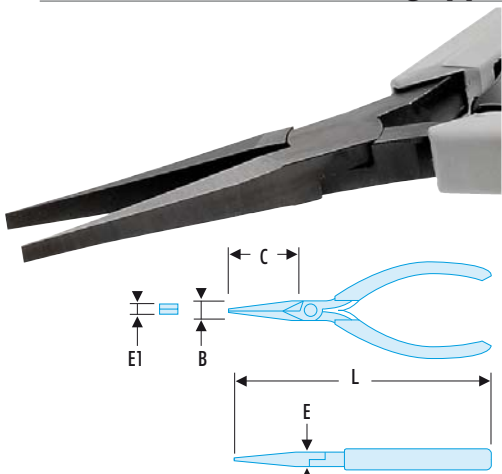

NF ISO 9655, ISO 9655, DIN ISO 9655, ASME B107.500

- Narrow mesh, for high precision works.
- Weight: 80 g.

	B [mm]	C [mm]	E [mm]	E1 [mm]	L [mm]
431.LMT	9	35	6	1	135

Micro-Tech® versatile mini-pliers

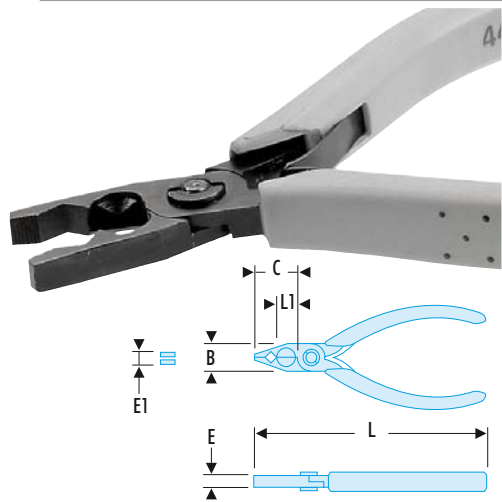

- Side wire-cutter, max capacity: diameter 1.7 mm on Cu; diameter 1 mm on soft iron.
- Rugged, grooved nose with pipe clamp.
- Presentation: anti-reflection mat black.
- Weight: 80 g.

	B [mm]	C [mm]	E [mm]	E1 [mm]	L [mm]	L1 [mm]
443.12MT	12	19	5	1	115	8

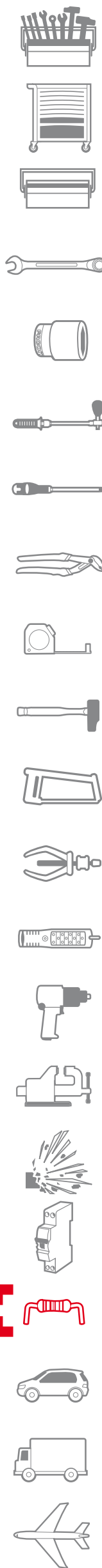

Half-round nose gripping pliers

HALF-ROUND NOSE PLIERS

- These pliers serve all professional needs in laboratory, production and maintenance applications.
- The half-round jaws are smooth with contoured inside edges to avoid damage to components.
- Matt black non-reflective finish.
- Leaf spring.

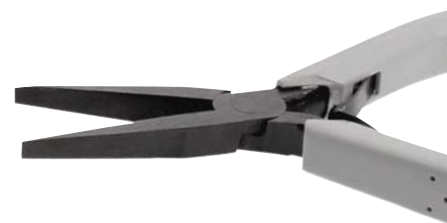

Micro-Tech® gripper «telephone» type

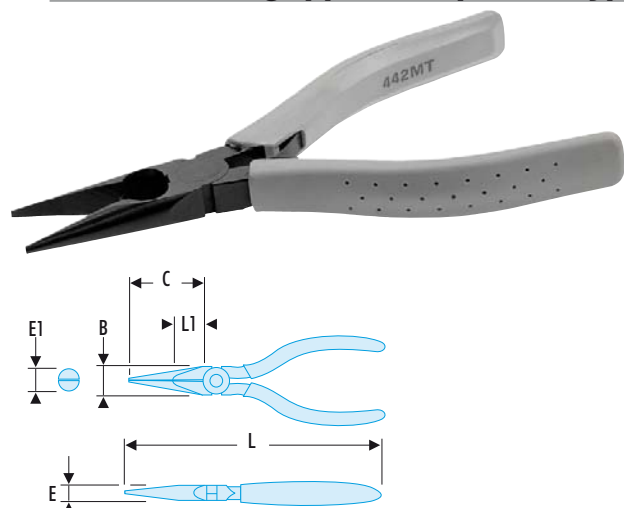

NF ISO 9655, ISO 9655, DIN ISO 9655, ASME B107.500

- Long, rugged, thin groove tip nose.
 - Side wire-cutter.
- Weight: 88 g.

➤	B [mm]	C [mm]	E [mm]	E1 [mm]	L [mm]	L1 [mm]	Fe wire 30 HRc diameter [mm]
442.MT	14	42	8	3,8	150	10	1

Micro-Tech® extra-long nose gripper pliers

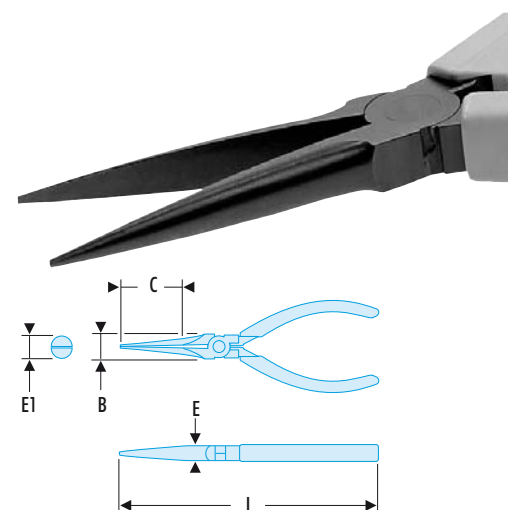

NF ISO 9655, ISO 9655, DIN ISO 9655, ASME B107.500

- For powerful loads.
- Weight: 76 g.

➤	B [mm]	C [mm]	E [mm]	E1 [mm]	L [mm]
402.MT	14	48	8	1,5	160

Micro-Tech® long and rigid nose grippers

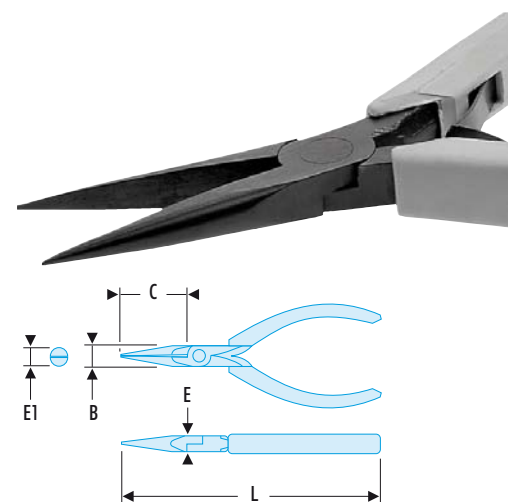

NF ISO 9655, ISO 9655, DIN ISO 9655, ASME B107.500

Weight: 70 g.

➤	B [mm]	C [mm]	E [mm]	E1 [mm]	L [mm]
422.MT	11	33	7	0,5	130

Micro-Tech® short nose gripper pliers

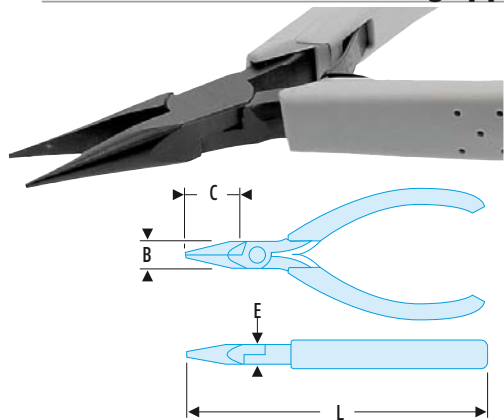

NF ISO 9655, ISO 9655, DIN ISO 9655, ASME B107.500

- Fine mesh.
- Weight: 55 g.

	B [mm]	C [mm]	E [mm]	L [m]
432.MT	9	26	6	120

Micro-Tech® thin nose grippers

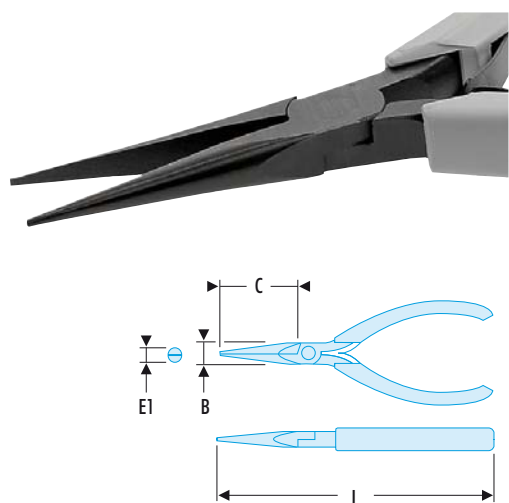

NF ISO 9655, ISO 9655, DIN ISO 9655, ASME B107.500

- Fine mesh, for high precision works.
- Weight: 65 g.

	B [mm]	C [mm]	E1 [mm]	L [mm]
432.LMT	9	35	1,6	140

Micro-Tech® extra-long angled nose grippers

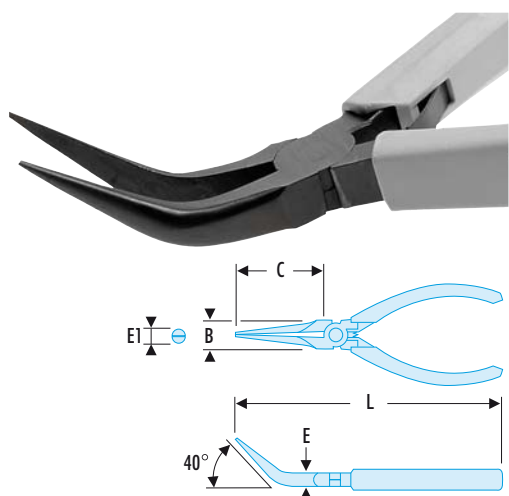

NF ISO 9655, ISO 9655, DIN ISO 9655, ASME B107.500

- For powerful loads.
- Weight: 75 g.

	B [mm]	C [mm]	L [mm]
403.MT	14	45	155

Micro-Tech® 60° angled rigid nose grippers

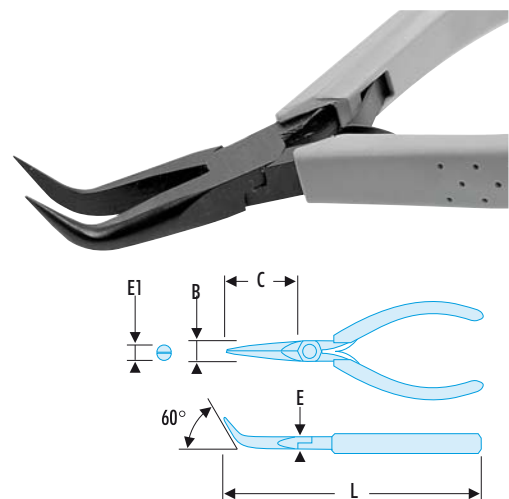

NF ISO 9655, ISO 9655, DIN ISO 9655, ASME B107.500

- Weight: 70 g.

	B [mm]	C [mm]	E [mm]	E1 [mm]	L [mm]
423.MT	11	25	7	1,4	125

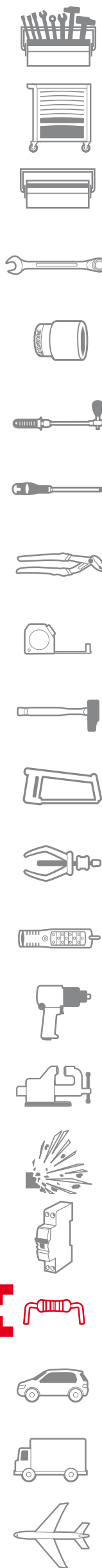

Micro-Tech® 45° angled thin nose grippers

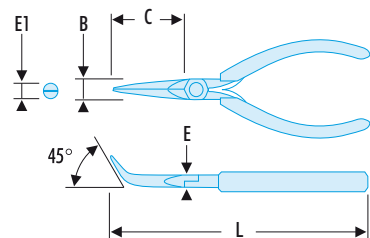

NF ISO 9655, ISO 9655, DIN ISO 9655, ASME B107.500

- Fine mesh, for high precision works.
- Weight: 75 g.

➤	B [mm]	C [mm]	E [mm]	E1 [mm]	L [mm]
433.LMT	9	35	6	1,6	135

Round nose pliers

Micro-Tech® short and rigid nose grippers

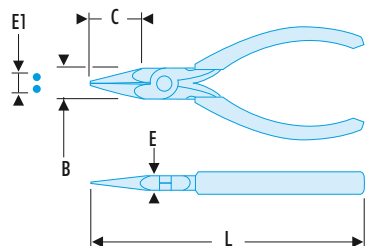

NF ISO 9655, ISO 9655, DIN ISO 9655, ASME B107.500

Weight: 55 g.

➤	B [mm]	C [mm]	E [mm]	E1 [mm]	L [mm]
424.MT	11	22	7	2	120

Pliers set

MOD.MT1 Micro-Tech® 6-pliers set



Comprising:

- 405.MT - 405.12MT - 406.MT - 406.8MT - 402.MT - 433.LMT.
- Heat-formed tray PL.612.

Weight: 0.650 kg.

ANTI-STATIC SERIES ELECTRONIC PLIERS

A DANGER FOR ELECTRONIC COMPONENTS!

As they become smaller and more sophisticated, electronic circuits are increasingly at risk from static electricity - especially when the charge can build up to several thousand volts.

Controlling electrostatic build-up (ESD) makes economic sense.

While the cost of a faulty component at acceptance-test stage is relatively small, it starts to increase once the component has reached the board, and escalates markedly once a fault involves sending back a complete unit.

But the most important benefit in controlling static electricity is customer satisfaction. Facom solves the problem with an antistatic range to EN 61340-5-1 & 2. For safe work on printed circuits, all tools and equipment used should be interlinked and effectively connected to earth. Measurements and tests on antistatic screwdrivers and electronics pliers have been carried out in laboratories approved by the electrical industry.

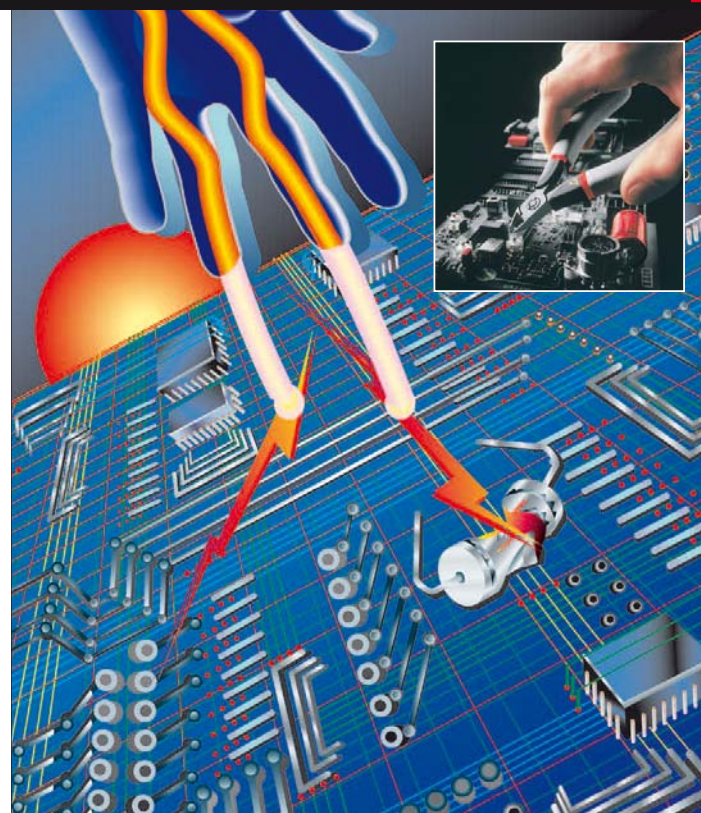

SAFETY FIRST
Never use antistatic tools when working on live components.

Diagonal cutting pliers

ESD BULLET-NOSE CUTTING PLIERS

- Are stronger than other profiles.
- Have a high cutting capacity and durability that are useful in a wide variety of applications.



AXIAL CUT
All applications, all materials.



SEMI-FLUSH CUT
Clean, long-life cut in semi-hard materials.



FLUSH CUT
Smooth cut for sound soldered connections.



ESD «small mesh» cutters: thin

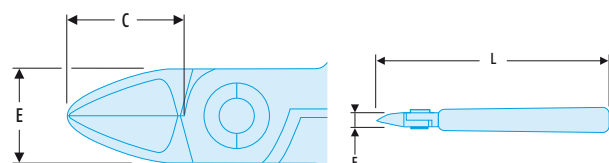

NF ISO 9654, ISO 9654, DIN ISO 9654, ASME B107.500

- Protection of electronic components from risks of electrostatic discharge (ESD).
 - These small mesh pliers are adapted to miniaturisation of electronic components.
 - The flush cutting model was extended to optimise access.
- Weight: 55 g.

Model	B [mm]	C [mm]	E [mm]	L [mm]	Cut	Fe wire 30 HRc diameter [mm]	Cu - Ni wire diameter [mm]
405.8E	8,5	9	6	110		0,5	0,2 - 1
406.8E	8,5	9	6	110		-	0,1 - 1
407.8E	8,5	9	6	110		-	0,1 - 1



ESD «compact» cutters: handling

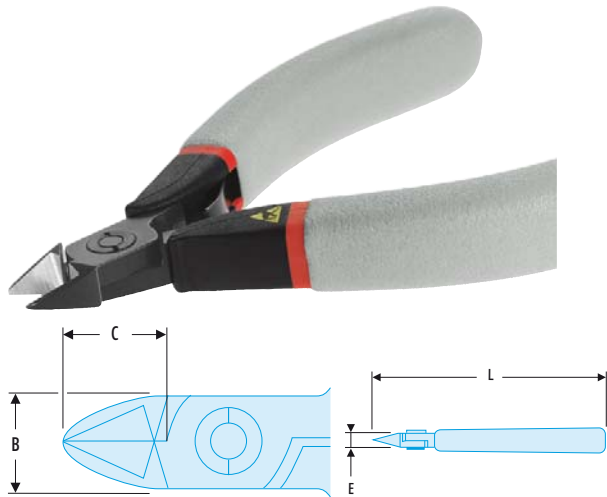

NF ISO 9654, ISO 9654, DIN ISO 9654, ASME B107.500

- Protection of electronic components from risks of electrostatic discharge (ESD).
 - These pliers combine cutting performance with handling thanks to their new slim diagonal shape.
 - The 405.MT pliers allow to cut piano wire up to 0.4 mm.
- Weight: 65 g.

➤	B [mm]	C [mm]	E [mm]	L [mm]	Cut	Fe wire 30 HRc diameter [mm]	Cu - Ni wire diameter [mm]	Piano Diameter [mm]
405.E	10,5	9,5	7	110	∧	0,7	0,3 - 1,3	0,4
406.E	10,5	9,5	7	110	∧	0,7	0,1 - 1,3	-
407.E	10,5	9,5	7	110	∧	-	0,1 - 1,3	-

ESD «rugged» cutters: versatility

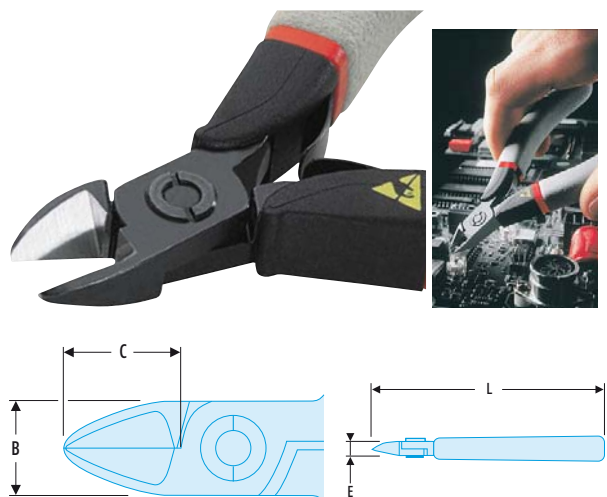

NF ISO 9654, ISO 9654, DIN ISO 9654, ASME B107.500

- Protection of electronic components from risks of electrostatic discharge (ESD).
 - These pliers allow neat cutting of multiple materials: from copper wire to piano wire up to 0.5 mm.
 - Fall prevention models avoid wire ejection.
- Weight: 65 g.

➤	B [mm]	C [mm]	E [mm]	L [mm]	Offcut retainer	Cut	Fe wire 30 HRc diameter [mm]	Cu - Ni wire diameter [mm]	Piano Diameter [mm]
405.10E	10,5	11,5	7	110	-	∧	0,8	0,3 - 1,4	0,5
405.10RE	10,5	11,5	7	110	•	∧	0,7	0,3 - 1,2	0,5

ESD «extended» cutters: access

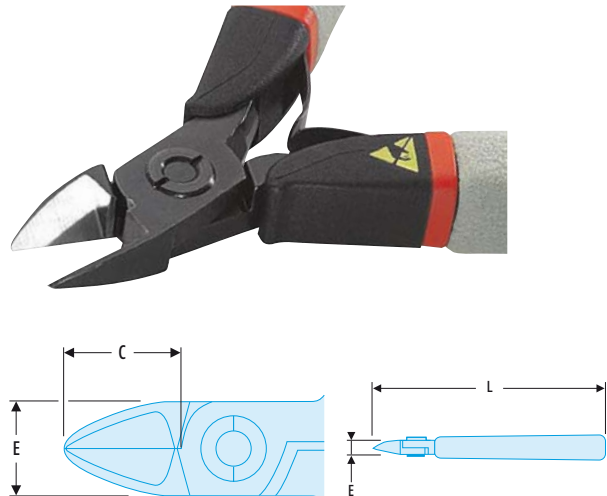

NF ISO 9654, ISO 9654, DIN ISO 9654, ASME B107.500

- Protection of electronic components from risks of electrostatic discharge (ESD).
 - These pliers allow to go further; up to + 1.5 to 2 mm compared with standard pliers.
 - Fall prevention models avoid wire ejection.
- Weight: 65 g.

➤	B [mm]	C [mm]	E [mm]	L [mm]	Offcut retainer	Cut	Fe wire 30 HRc diameter [mm]	Cu - Ni wire diameter [mm]
425.E	10,5	13	7	110	-	∧	-	0,1 - 1,3
435.E	10,5	13	7	110	-	∧	0,7	0,1 - 1,3
435.RE	10,5	13	7	110	•	∧	0,7	0,1 - 1,2

ESD «long thin» cutters with clearance

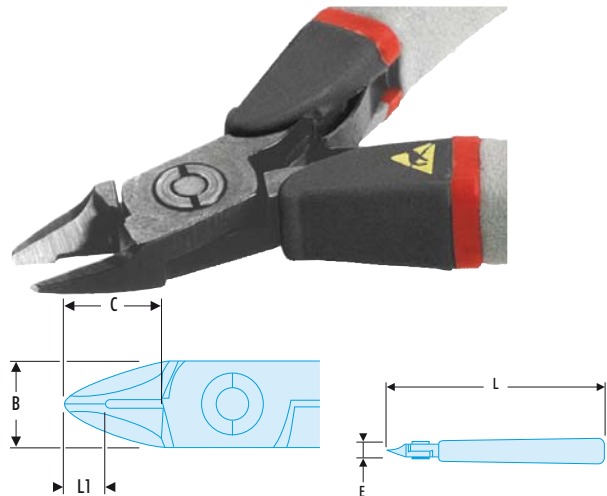

NF ISO 9654, ISO 9654, DIN ISO 9654, ASME B107.500

- Protection of electronic components from risks of electrostatic discharge (ESD).
 - These pliers allow to cut behind components and pass under obstacles (coils, resistors...).
- Weight: 65 g.

➤	B [mm]	C [mm]	E [mm]	L [mm]	L [m]	L1 [mm]	Cut	Fe wire 30 HRc diameter [mm]	Cu - Ni wire diameter [mm]
426.E	10,5	13	7	110	110	5,5	∧	-	0,1 - 1,2

ESD «high capacity» cutters:

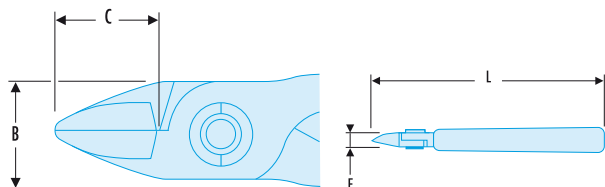

NF ISO 9654, ISO 9654, DIN ISO 9654, ASME B107.500

- Protection of electronic components from risks of electrostatic discharge (ESD).
 - These pliers are suited to major efforts and repetitive work over a broad range of materials.
 - Fall prevention models avoid wire ejection.
- Weight: 105 g.

➤	B [mm]	C [mm]	E [mm]	L [mm]	Cut	Fe wire 30 HRc diameter [mm]	Cu - Ni wire diameter [mm]
405.12E	16	16	8	130		1,0	0,4 - 2,0
415.E	16	16	8	130		1,0	0,3 - 2,0

Slim nose cutting pliers

ESD POINTED-NOSE PLIERS

- Are ideal where clearance is restricted and allow better visibility of the wire being cut.



SEMI-FLUSH CUT

Clean, long-life cut in semi-hard materials.



FLUSH CUT

Smooth cut for sound soldered connections.



ESD «tip» cutters

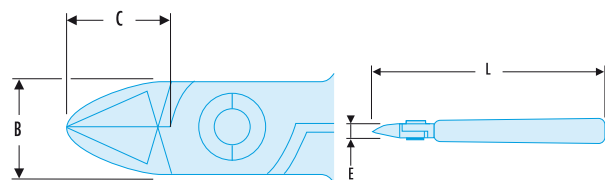

NF ISO 9654, ISO 9654, DIN ISO 9654, ASME B107.500

- Protection of electronic components from risks of electrostatic discharge (ESD).
 - Compact noses for difficult access.
- Weight: 65 g.

➤	B [mm]	C [mm]	E [mm]	L [mm]	Cut	Fe wire 30 HRc diameter [mm]	Cu - Ni wire diameter [mm]
416.E	10,5	10,5	7	110		0,5	0,1 - 1,0

ESD thin nose «machined» cutters: handling

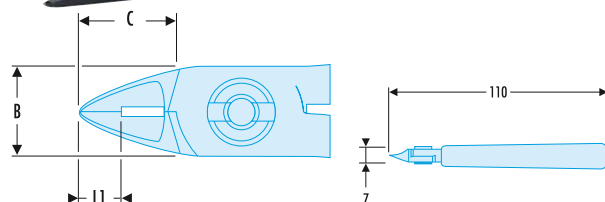

NF ISO 9654, ISO 9654, DIN ISO 9654, ASME B107.500

- Protection of electronic components from risks of electrostatic discharge (ESD).
 - These pliers pass under all obstacles of the PCB and provide better visibility.
- Weight: 65 g.

➤	B [mm]	C [mm]	E [mm]	L [mm]	L1 [mm]	Cut	Fe wire 30 HRc diameter [mm]	Cu - Ni wire diameter [mm]
416.PE	10,5	10,5	7	110	6,5		0,4	0,1 - 0,8
417.PE	10,5	10,5	7	110	6,5		-	0,1 - 0,8

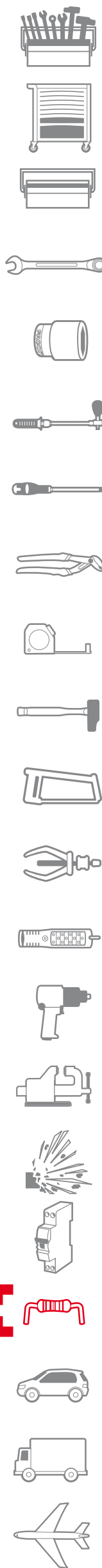

ESD «high capacity machined» cutters

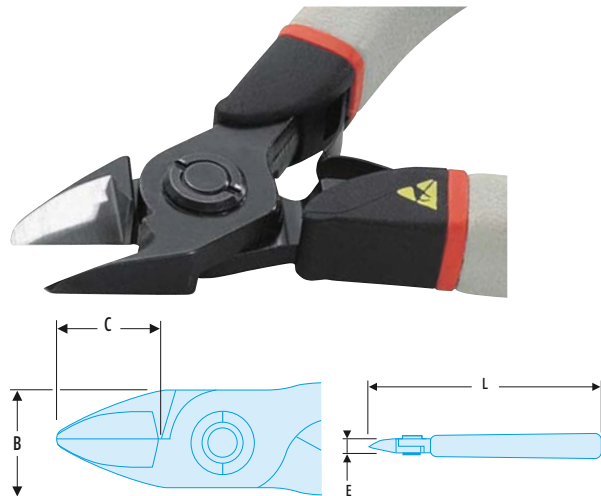

NF ISO 9654, ISO 9654, DIN ISO 9654, ASME B107.500

- Protection of electronic components from risks of electrostatic discharge (ESD).
 - Broadly dimensioned for large series works.
- Weight: 105 g.

➤	B [mm]	C [mm]	E [mm]	L [mm]	Cut	Fe wire 30 HRc diameter [mm]	Cu - Ni wire diameter [mm]
416.12E	16	16	8	130		0,7	0,3 - 1,6

Angled nose cutting pliers

ESD ANGLED-NOSE PLIERS

- Ideal for use on printed circuits, electronic modules and hybrid circuits.
- Designed for cutting right up against the board in the minutest spaces.
- Flush cutting edges.



FLUSH CUT
Smooth cut for sound soldered connections.



ESD 30° angled cutters

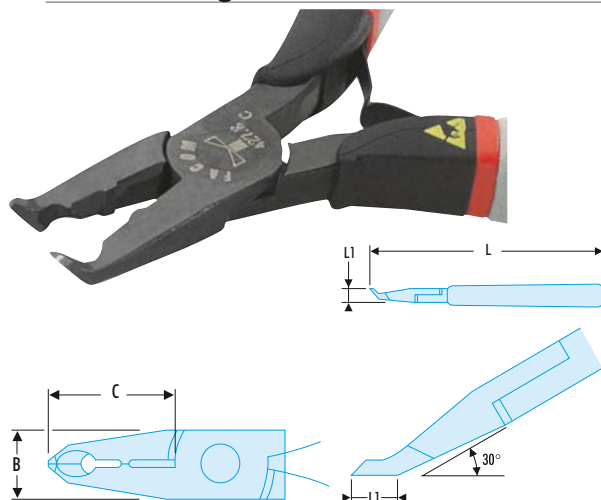

NF ISO 9654, ISO 9654, DIN ISO 9654, ASME B107.500

- Protection of electronic components from risks of electrostatic discharge (ESD).
 - Cutting edges angled at 30° with rear clearance.
- Weight: 65 g.

➤	B [mm]	C [mm]	E [mm]	L [mm]	L1 [mm]	Cut	Fe wire 30 HRc diameter [mm]	Cu - Ni wire diameter [mm]
427.E	11	23	7	120	6		-	0,2 - 0,6

ESD 70° «angled» cutters

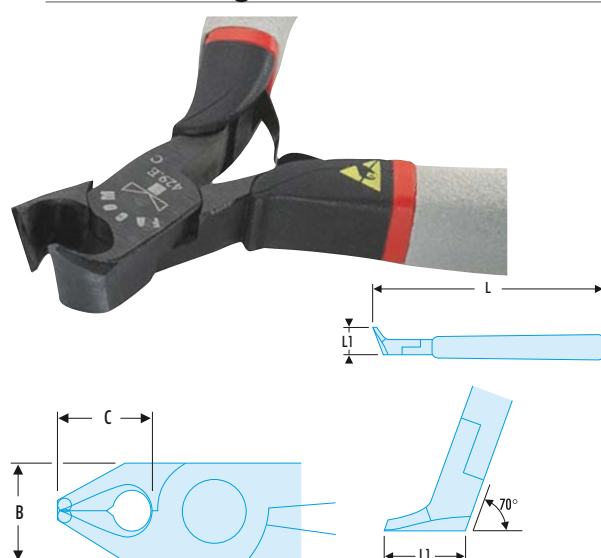

NF ISO 9654, ISO 9654, DIN ISO 9654, ASME B107.500

- Protection of electronic components from risks of electrostatic discharge (ESD).
 - Cutting edges angled at 70° with rear clearance.
- Weight: 66 g.

➤	B [mm]	C [mm]	E [mm]	L [mm]	L1 [mm]	Cut	Fe wire 30 HRc diameter [mm]	Cu - Ni wire diameter [mm]
429.E	11,5	12	7	110	12		-	0,2 - 1,0

Cutting pliers for DIP-CMS components

ESD diagonal cutters for DIP-CMS components

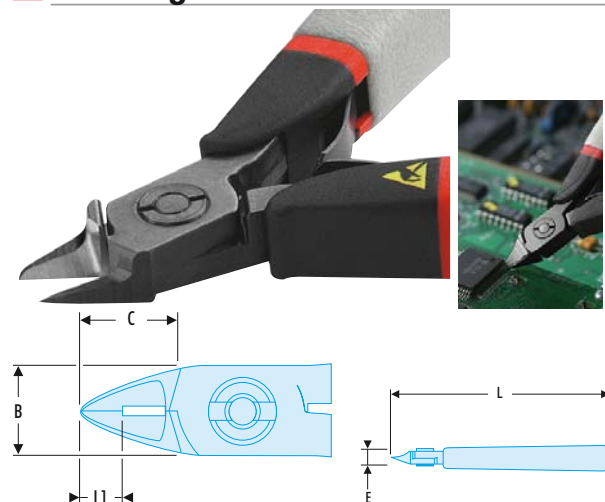

NF ISO 9654, ISO 9654, DIN ISO 9654, ASME B107.500

- Protection of electronic components from risks of electrostatic discharge (ESD).
 - These pliers provide access between two legs of "DIP" components with a 0.65 mm gap. Due to their shape, these pliers can be used only in this configuration.
- Weight: 60 g.

	B [mm]	C [mm]	E [mm]	L [mm]	L1 [mm]	Cut	Cu - Ni wire diameter [mm]
417.SPE	10,5	10,5	7	110	6,5		0,1 - 0,7

ESD diagonal cutters for DIP components

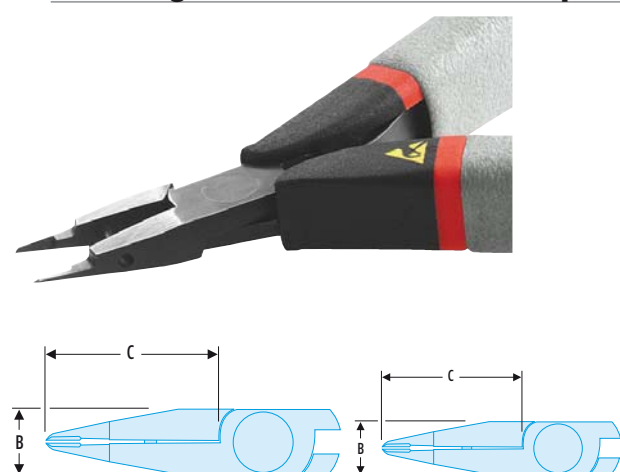

- Protection of electronic components from risks of electrostatic discharge (ESD).
 - These pliers have a thin and pointy head to provide total access to DIP or CMS components in circuits.
 - Cut: flush.
- Weight: 40 g.

	B [mm]	C [mm]	L [mm]	Cu - Ni wire diameter [mm]
437.E	9	18	118	

Gripping pliers

ESD flat nose shaping cutters

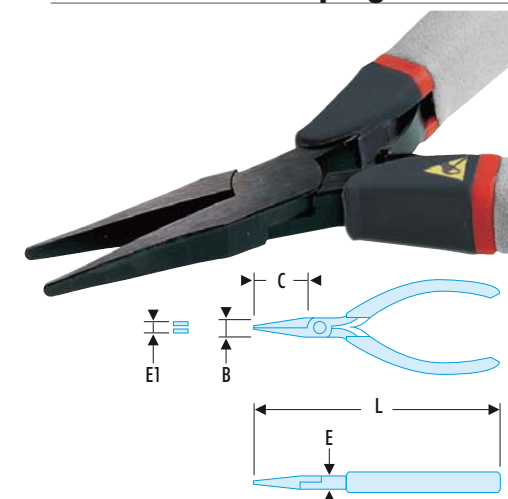

NF ISO 9655, ISO 9655, DIN ISO 9655, ASME B107.500

- Protection of electronic components from risks of electrostatic discharge (ESD).
 - Very thin nose.
- Weight: 65 g.

	B [mm]	C [mm]	E [mm]	E1 [mm]	L [mm]
420.E	9	21	7	1	125

ESD short flat nose cutters

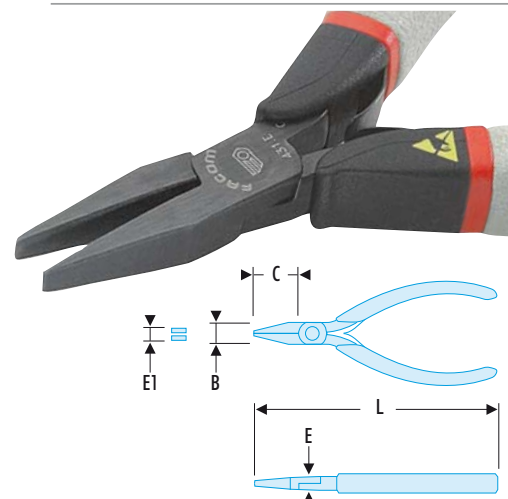

NF ISO 9655, ISO 9655, DIN ISO 9655, ASME B107.500

- Protection of electronic components from risks of electrostatic discharge (ESD).
 - Narrow mesh, for high precision works.
- Weight: 75 g.

	B [mm]	C [mm]	E [mm]	E1 [mm]	L [mm]
431.E	9	20	6	1	135

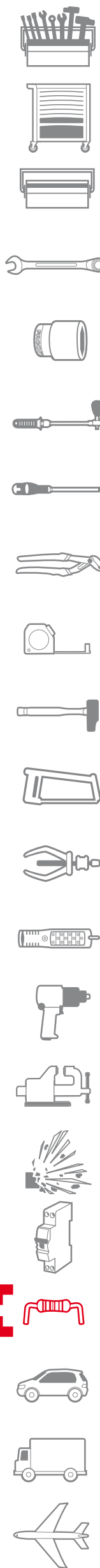

ESD thin flat-nose pliers

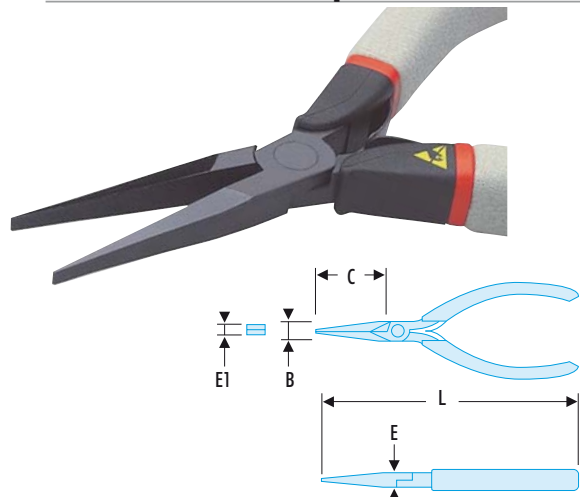

NF ISO 9655, ISO 9655, DIN ISO 9655, ASME B107.500

- Protection of electronic components from risks of electrostatic discharge (ESD).
- Narrow mesh, for high precision works.

Weight: 75 g.

➤	B [mm]	C [mm]	E [mm]	E1 [mm]	L [mm]
431.LE	9	35	6	1	135

ESD half-round nose cutters

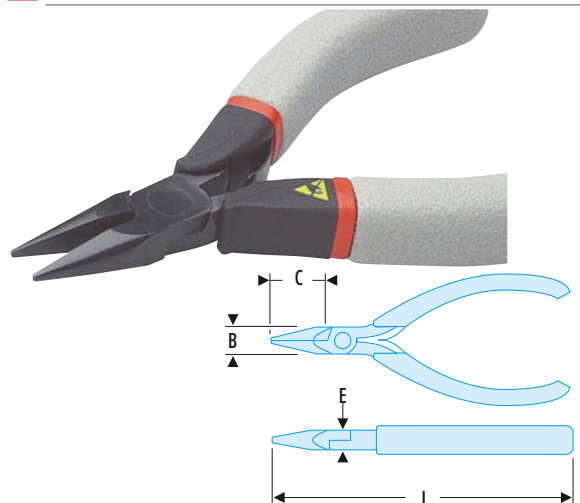

NF ISO 9655, ISO 9655, DIN ISO 9655, ASME B107.500

- Protection of electronic components from risks of electrostatic discharge (ESD).
- Fine mesh.

Weight: 70 g.

➤	B [mm]	C [mm]	E [mm]	L [mm]
432.E	9	26	6	120

ESD half-round thin nose cutters

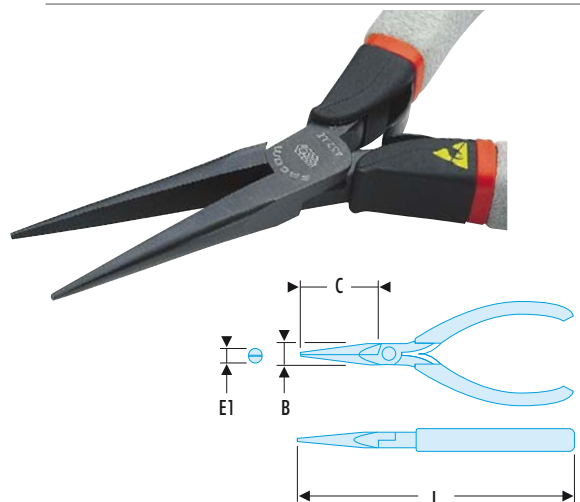

NF ISO 9655, ISO 9655, DIN ISO 9655, ASME B107.500

- Protection of electronic components from risks of electrostatic discharge (ESD).
- Narrow mesh, for high precision works.

Weight: 70 g.

➤	B [mm]	C [mm]	E1 [mm]	L [mm]
432.LE	9	35	1,6	140

ESD half-round angled nose cutters

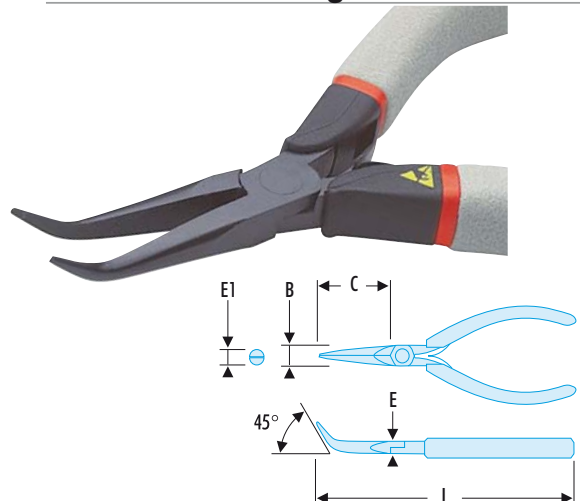

NF ISO 9655, ISO 9655, DIN ISO 9655, ASME B107.500

- Protection of electronic components from risks of electrostatic discharge (ESD).
- 45° angled nose.
- Narrow mesh, for high precision works.

Weight: 70 g.

➤	B [mm]	C [mm]	E [mm]	E1 [mm]	L [mm]
433.LE	9	35	6	1,6	135

MICRO-TECH® SCREWDRIVERS

1 Efficient

The screwdriver end is designed to provide an effective pressure area in each of the three micro-engineering screwdriver positions. This end also rotates to optimise the turning motion.

2 3 Powerful and accurate

The body comprises a gripping surface designed for optimum torque transmission with handling accuracy. The handle is shaped so fingers can naturally grip the specially designed handle for total tool control.

4 Quick and easy to use

The ribbed cone provides maximum grip for fast pre-tightening. Blade clearance gives a clear view of the job in hand.

5 A large choice of blades

A selection of over 50 high-precision steel or ceramic fixed or replaceable blades.

6 Easy identification

Colour-coded by size for instant selection of the correct tool.



Finger-tip grip area



Watch makers grip area

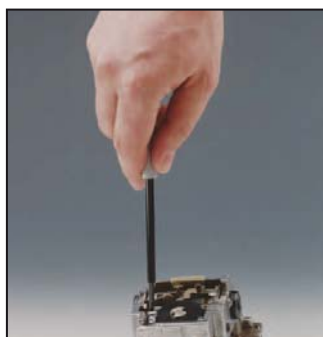

Full palm grip area

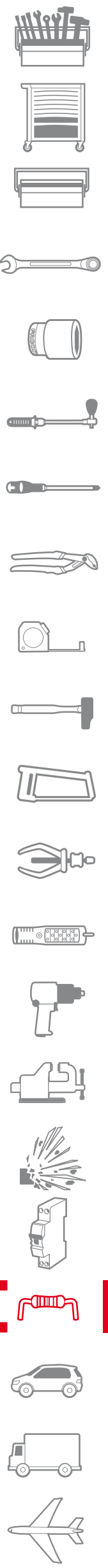
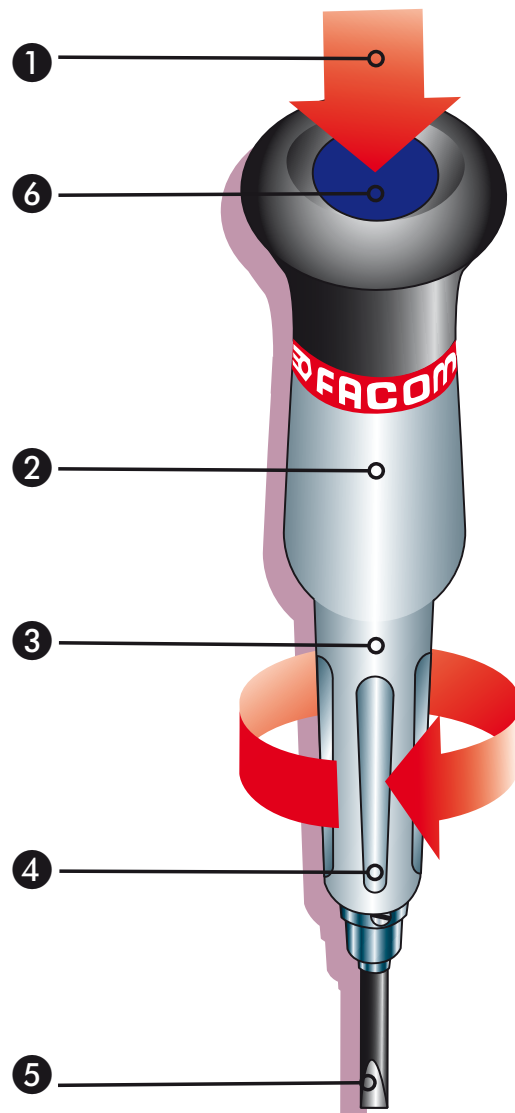

AEF -AEP - Micro-Tech® replaceable blade screwdriver

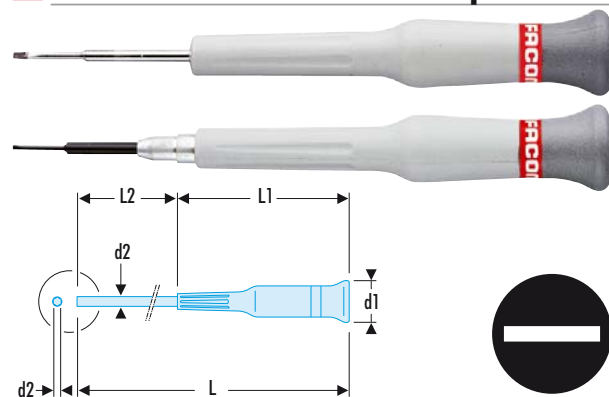

- Swivel head.
- Presentation: chromed blade, hardened tip.

Icon	Color	d1 x L1 [mm]	d2 x L2 [mm]	L [mm]	ΔΔ [g]
AEF.1X35	Red	17 x 82	1,0 x 35	117	11,5
AEF.1,2X35	Orange	17 x 82	1,2 x 35	117	11,5
AEF.00X35	Purple	17 x 82	2,5 x 35	117	11,5

AEF - Micro-Tech® screwdriver for slotted head screw

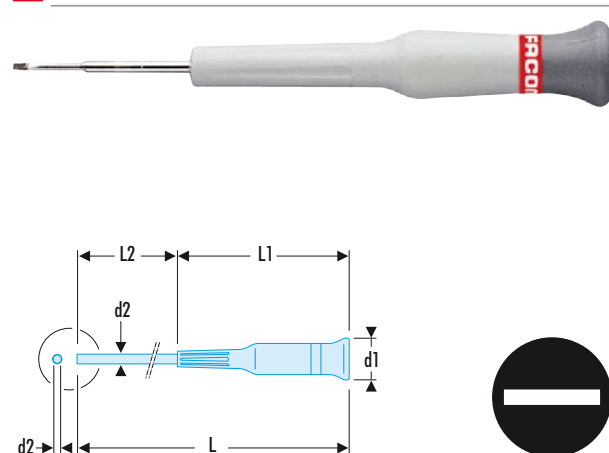

- Swivel head.
- Presentation: chromed blade, hardened tip.

Icon	Color	d1 x L1 [mm]	d2 x L2 [mm]	L [mm]	ΔΔ [g]
AEF.1,5X35	Yellow	17 x 82	1,5 x 35	117	12,1
AEF.1,8X35	Green	17 x 82	1,8 x 35	117	13,2
AEF.2X35	Indigo	17 x 82	2,0 x 35	117	13,5
AEF.2X75	Indigo	17 x 82	2,0 x 75	157	14,5
AEF.2,5X35	Blue	17 x 82	2,5 x 35	117	13,3
AEF.2,5X75	Blue	17 x 82	2,5 x 75	157	14,5
AEF.3X75	Pink	21 x 93	3,0 x 75	168	21,2
AEF.3,5X75	Purple	21 x 93	3,5 x 75	168	24,7
AEF.4X75	Plum	21 x 93	4,0 x 75	168	26,4

AEFP - AEFD Micro-Tech® screwdriver for Phillips® and Pozidriv® pattern

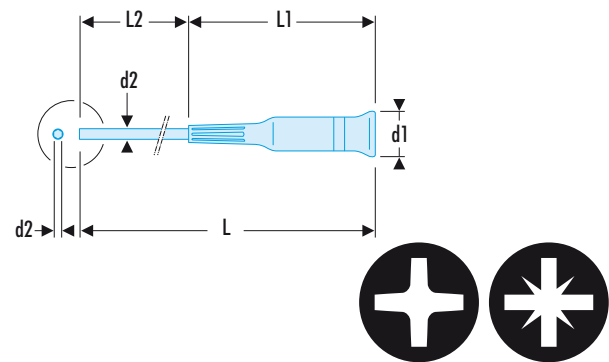

- AEFP presentation: chromed blade, hardened tip.
- AEFD presentation: hardened blade.

➤	🎨	Phillips [No]	Pozidriv [No]	d1 x L1 [mm]	d2 x L2 [mm]	L [mm]	ΔΔ [g]
AEFP.000X35	Pink	PH.000	-	17 x 82	2 x 35	117	11,5
AEFP.00X35	Purple	PH.00	-	17 x 82	2,5 x 35	117	12,5
AEFP.00X75	Purple	PH.00	-	17 x 82	2,5 x 75	157	14,9
AEFP.0X35	Plum	PH.0	-	17 x 82	3,0 x 35	117	13,5
AEFP.0X75	Plum	PH.0	-	21 x 93	3,0 x 75	168	32,2
AEFP.1X75	Brown	PH.1	-	21 x 93	4,0 x 75	168	37,5
AEFD.0X35	Orange	-	PZ.0	17 x 82	3,0 x 35	117	13,5
AEFD.0X75	Orange	-	PZ.0	21 x 93	3,0 x 75	168	32,2
AEFD.1X75	Brown	-	PZ.1	21 x 93	4,0 x 75	168	37,5

AEX - Micro-Tech® screwdriver for Torx® screw

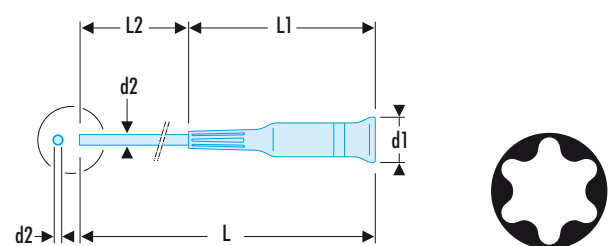

- Presentation: chromed blade, hardened tip.

➤	🎨	Torx [No]	d1 x L1 [mm]	d2 x L2 [mm]	L [mm]	ΔΔ [g]
AEX.5X35	Green	T5	17 x 82	2,0 x 35	117	13,0
AEX.6X35	Indigo	T6	17 x 82	2,0 x 35	117	13,3
AEX.7X35	Blue	T7	17 x 82	2,5 x 35	117	13,3
AEX.8X75	Pink	T8	21 x 93	2,5 x 75	168	31,7
AEX.9X75	Purple	T9	21 x 93	3,0 x 75	168	32,6
AEX.10X75	Plum	T10	21 x 93	3,0 x 75	168	32,6
AEX.15X75	Brown	T15	21 x 93	3,5 x 75	168	35,0
AEX.20X75	Grey	T20	21 x 93	4,0 x 75	168	40,8

84E - Micro-Tech® screwdriver for male hex screws



- Presentation: hardened blade.

➤	🎨	⚙️ 6-point [mm]	L [mm]	ΔΔ [g]
84E.0,9X35	Red	0,9	117	14,4
84E.1,3X35	Orange	1,3	117	15,0
84E.1,5X35	Yellow	1,5	117	15,0
84E.1,5X75	Yellow	1,5	157	15,0
84E.2X75	Green	2,0	168	30,0
84E.2,5X75	Indigo	2,5	168	32,0

Micro-Tech® bit holder screwdriver for hex screws 4 mm

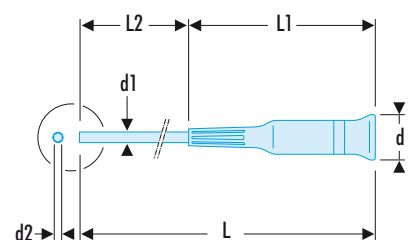

- For bits series 0 - 4 mm drive.
- Presentation: hardened blade.

➤	A [mm]	d [mm]	d1 [mm]	L [mm]	L1 [mm]	L2 [mm]	ΔΔ [g]
AEM.M	4	21	6	167	93	72	49,6

Bits series 0 - 4 mm drive

ES.0 - Screwing bits series 0-drive 4 mm for slotted head screw

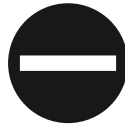
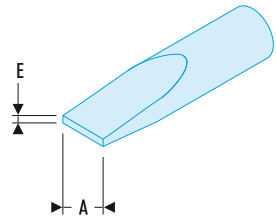

ES	A fente [No]	E [mm]	L [mm]	ΔΔ [g]
ES.001,8	1,8	0,3	28	3,0
ES.002	2,0	0,4	28	3,0
ES.002,5	2,5	0,4	28	3,1
ES.003	3,0	0,5	28	3,1
ES.004	4,0	0,5	28	3,2
ES.004,5	4,5	0,6	28	3,2

EP.0 - Screwing bits series 0-drive 4 mm for Phillips® screws



EP	Phillips [No]	L [mm]	ΔΔ [g]
EP.0X2	PH00	28	3,2
EP.000	PH0	28	3,2

EP.0 - Screwing bits series 0-drive 4 mm for Pozidriv® screws



ED	Pozidriv [No]	L [mm]	ΔΔ [g]
ED.0X2	PZ00	28	3,2
ED.000	PZ0	28	3,2
ED.001	PZ1	28	3,2

EH.0 - Screwing bits series 0-drive 4 mm for hollow hex screws



EH	6-point [mm]	L [mm]	ΔΔ [g]
EH.000,9	0,9	28	3,0
EH.001,3	1,3	28	3,1
EH.001,5	1,5	28	3,1
EH.002	2,0	28	3,2
EH.002,5	2,5	28	3,2

ETS.0 - Screwing bits series 0-drive 4 mm for hollow hex spherical head screws



• The spherical head allows to screw with an angle up to 30°.

ETS	6-point [mm]	L [mm]	ΔΔ [g]
ETS.001,5	1,5	28	3,1
ETS.002	2,0	28	3,2
ETS.002,5	2,5	28	3,2

EX.0 - Screwing bits series 0-drive 4 mm for Torx® screws

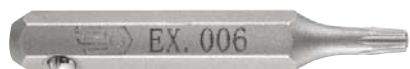

EX	Torx [No]	L [mm]	ΔΔ [g]
EX.006	T6	28	3,1
EX.007	T7	28	3,2
EX.008	T8	28	3,2
EX.010	T10	28	3,2

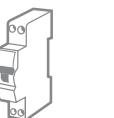
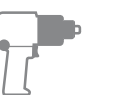

▣ ECR.0 Socket holder drive



- Bit to use 1/4" "radio" series sockets with the screwdriver series A.300MT and A.340MT.
- Hex drive 4 mm.
- Length: 22 mm.
- Weight: 7 g.

Micro-Tech® screwdriver kits

▣ AEF.J1 Micro-Tech® 5-piece screwdriver set slotted head - Phillips®



Comprising:

- 4 slotted head screwdriver: AEF.1.5x35 - AEF.1.8x35 - AEF.2x35 - AEF.2.5x35.
- 1 Phillips® screwdriver: AEFP.00x35.
- Case dimensions: L.178 x W.91 x H.25.
- Weight: 170 g.



▣ AEF.J3 Micro-Tech® 8-piece screwdriver set slotted head - Phillips®



Comprising:

- 5 slotted head screwdriver: AEF.2x75 - AEF.2.5x75 - AEF.3x75 - AEF.3.5x75 - AEF.4x75.
- 3 Phillips® screwdriver: AEFP.00x75 - AEFP.0x75 - AEFP.1x75.
- Case dimensions: L.205 x W.130 x H.31 mm.
- Weight: 384 g.



▣ AEF.J5 Micro-Tech® 5-piece screwdriver set slotted head - Pozidriv®



Comprising:

- 3 slotted head screwdriver: AEF.2x75 - AEF.2.5x75 - AEF.3x75.
- 2 Pozidriv® screwdrivers: AEFD.0x75 - AEFD.1x75.
- Case dimensions: L.183 x W.109 x H.32 mm.
- Weight: 230 g.



▣ **AEF.J6** Micro-Tech® 8-piece screwdriver set slotted head - Phillips® - Pozidriv®



Comprising:

- 5 slotted head screwdriver: AEF.2x75 - AEF.2.5x75 - AEF.3x75 - AEF.3.5x75 - AEF.4x75.
- 1 Phillips® screwdriver: AEFP.00x75.
- 2 Pozidriv® screwdrivers: AEFD.0x75 - AEFD.1x75.
- Case dimensions: L.215 x W.130 x H.31 mm.
- Weight: 385 g.

▣ **AEFP.J1** Micro-Tech® 5-piece screwdriver set Phillips®



Comprising:

- 5 Phillips® screwdriver: AEFP.00x35 - AEFP.00x75 - AEFP.0x35 - AEFP.0x75 - AEFP.1x75.
- Case dimensions: L.183 x W.109 x H.32 mm.
- Weight: 267 g.

▣ **AEF.J2** Micro-Tech® 5-piece screwdriver slotted head



Comprising:

- 5 slotted head screwdriver: AEF2x75 - AEF2.5x75 - AEF3x75 - AEF3.5x75 - AEF4x75.
- Case dimensions: L.183 x W.109 x H.32 mm.
- Weight: 237 g.

▣ **AE.J1** Micro-Tech® 8-piece screwdriver set replaceable blade slotted head - Phillips®



Comprising:

- 6 slotted head screwdriver: AE.1x35 - AE.1.2x35 - AE.1.5x35 - AE.1.8x35 - AE.2x35 - AE.2.5x35.
- 2 Phillips® screwdriver: AEP.000x35 - AEP.00x35.
- Case dimensions: L.205x W.130 x H.31 mm.
- Weight: 270 g.

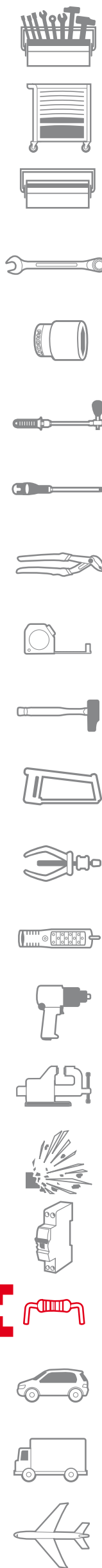

▣ AEX.J1 Micro-Tech® 5-piece screwdriver set Torx®



Comprising:

- 5 Torx® screwdrivers: AEX.6x35 - AEX.7x35 - AEX.8x75 - AEX.9x75 - AEX.10x75.
 - Case dimensions: L.183x W.109 x H.32 mm.
- Weight: 280 g.

▣ AEX.J2 Micro-Tech® 8-piece screwdriver set Torx®



Comprising:

- 8 Torx® screwdrivers: AEX.5x35 - AEX.6x35 - AEX.7x35 - AEX.8x75 - AEX.9x75 - AEX.10x75 - AEX.15x75 - AEX.20x75.
 - Case dimensions: L.205 x W.130 x H.31 mm.
- Weight: 335 g.

▣ 84E.J1 5-piece set of hex screwdrivers



Comprising:

- 5 hex screwdrivers: 84E.0.9x35 - 84E.1.3x35 - 84E.1.5x35 - 84E.2x75 - 84E.2.5x75.
 - Case dimensions: L.183 x W.109 x H.32 mm.
- Weight: 250 g.

Micro-Tech® kit

▣ 10-piece Micro-Tech® set of short combination wrench



NF ISO 691, NF ISO 7738, NF ISO 3318, NF ISO 1711-1, E74-306, ISO 691, ISO 7738, ISO 3318, ISO 1711-1, DIN ISO 1711-1, DIN ISO 691, ASME B107.100

Comprising:

- 10 combination wrenches series 39: 3.2 - 4 - 5 - 5.5 - 6 - 7 - 8 - 9 - 10 - 11 mm.
 - Case dimensions: L. 123 x W.95 x H.28 mm.
- Weight: 240 g.

➤	A [mm]	ΔΔ [kg]
39.JE10	3,2 - 4 - 5 - 5,5 - 6 - 7 - 8 - 9 - 10 - 11	1,700

▣ **MT.J2** Micro-Tech® 8-tool set



- Comprising:
- 1 mirror 834.R1.
 - 1 spring-puller 835.A.
 - 2 mechanical fingers 826.0 - 827.2.
 - 1 screw fitter AFU.0.
 - 1 pen light 836.
 - 1 nut fitter 825.MT.
 - 1 tool holder 1817.
 - Case dimensions: L.285 x W.138 x H.26 mm.
 - Weight: 627 g.

▣ **MT.J3** Micro-Tech® 11-tool set



- Comprising:
- 5 slotted head screwdrivers: AE.1.2 x 35 - AEF.1.5 x 35 - AEF.1.8 x 35 - AEF.2 x 35 - AEF.2.5 x 35.
 - 3 Phillips® screwdrivers: AEFP.000 x 35 - AEFP.00 x 35 - AEFP.0 x 35.
 - 1 pair of tweezers: 140A.
 - 2 pair of pliers: 405.10 MT - 432 LMT.
 - Case dimensions: L.285 x W.138 x H.26 mm.
 - Weight: 726 g.

▣ **MT.J1** Micro-Tech® 16-tool set



- Comprising:
- 6 slotted head screwdrivers: AE.1 x 35 - AE.1.2 x 35 - AEF.1.5 x 35 - AEF.1.8 x 35 - AEF.2 x 35 - AEF.2.5 x 35.
 - 2 Phillips® screwdrivers: AEP.000 x 35 - AEFP.00 x 35.
 - 3 hex screwdrivers: 84E.0.9 x 35 - 84E.1.3 x 35 - 84E.1.5 x 35 .
 - 2 pairs of pliers 405.10MT- 432LMT.
 - 1 pair of scissors 841.1.
 - 1 cutter 845.1.
 - 1 pair of tweezers 140AA.
 - Case dimensions: L.366 x W.180 x H.66 mm.
 - Weight: 1075 g.

▣ **AEM.J1** Micro-Tech® 16-tool set - screwdriver + bits



- Comprising:
- 1 bit holder screwdriver AEM.M.
 - 5 bits series 0 for slotted head screw: ES.002 - ES.002.5 - ES.003 - ES.004 - ES.004.5.
 - 2 bits series 0 for Phillips®: EP.0x2 - EP.000.
 - 2 bits series 0 for Pozidriv®: ED.0x2 - ED.000.
 - 3 bits series 0 hex: EH.001.5 - EH.002 - EH.002.5.
 - 3 bits series 0 hex spherical head: ETS.001.5 - EH.002 - EH.002.5.
 - Case dimensions: 183 x 109 x 32 mm.
 - Weight: 237 g.

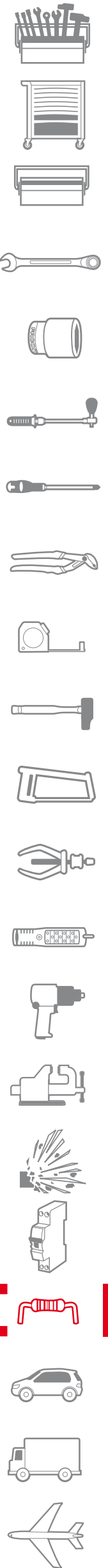

▣ AEM.J2 Micro-Tech® 26-tool set - socket holder + bits + sockets



Comprising:

- 1 bit holder screwdriver AEM.M.
- 5 bits series 0 for slotted head screw: ES.002 - ES.002.5 - ES.003 - ES.004 - ES.004.5.
- 2 bits series 0 for Phillips®: EP.0x2 - EP.000.
- 2 bits series 0 for Pozidriv®: ED.0x2 - ED.000.
- 3 bits series 0 hex: EH.001.5 - EH.002 - EH.002.5.
- 3 bits series 0 hex spherical head: ETS.001.5 - EH.002 - EH.002.5.
- 4 bits series 0 for Torx: EX.006 - EX.007 - EX.008 - EX.010.
- 1 socket holder ECR.0.
- 5 1/4" sockets: R.3.2 - 4 - 5 - 5.5 - 7 mm.
- Case dimensions: 205 x 130 x 31 mm.
- Weight: 340 g.

Clockmakers screwdrivers set

▣ HB.1B 5-piece watchmaker screwdriver set for slotted head screw



Comprising:

- 5 screwdrivers for slotted head screw: 0.8 x 13 - 1 x 16 - 1.2 x 17 - 1.6 x 19 - 2.5 x 21 mm.
- Presentation: chromed, hardened blade.
- In plastic case.
- Weight: 130 g.

▣ HB.2B 6-piece watchmaker screwdriver set for Phillips® - hex screw



Comprising:

- 3 hex screwdrivers: 1.5 - 2 - 2.5 mm.
- 3 Phillips® screwdrivers: PH N°00 - 0 - 1.
- Presentation: chromed, hardened blade.
- In plastic case.
- Weight: 200 g.

▣ HB.4 9-piece watchmaker screwdriver set for slotted head screw



Comprising:

- 9 slotted head screwdrivers: 0.6x11 - 0.8x11 - 1x12 - 1.2x12 - 1.4x12 - 1.6x15 - 2x15 - 2.5 x 15.5 - 3x15.5 mm.
- Replaceable blades.
- Supplied on carousel with blade reserve.
- Weight: 340 g.

Standard series

140 - Tweezers anti-magnetic or anti-reflection straight models



- Smooth pointed nose.
- 140.AA: satin polished presentation. Anti-magnetic stainless steel material.
- 140.AAW13: anti-reflection black presentation. Carbon steel material.

🔪	L [mm]	ΔΔ [g]
140.AA	125	17
140.AAW13	130	16

148 Tweezers straight model - narrow nose



- Smooth narrow and pointed nose.
- Stainless steel.
- Presentation: fine polished.
- Length: 130 mm.
- Weight: 15 g.

149 Tweezers straight model - fine grooved nose



- Long, thin, groove tip nose with guide.
- Stainless steel.
- Presentation: fine polished.
- Length: 155 mm.
- Weight: 18 g.

150 Tweezers straight model - strong grooved nose



- Long, strong, groove tip nose with guide.
- Stainless steel.
- Presentation: fine polished.
- Length: 165 mm.
- Weight: 22 g.

151 Tweezers model angled at 40°



- Long, strong, groove tip nose with guide.
- Stainless steel.
- Presentation: fine polished.
- Length: 155 mm.
- Weight: 22 g.

152 Tweezers model angled at 45°



- Thin, grooved nose with guide.
- Stainless steel.
- Presentation: fine polished.
- Length: 150 mm.
- Weight: 19 g.

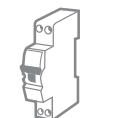
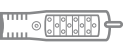
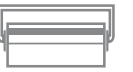

▣ 153 Tweezers straight model - cross nose



- Grooved, crossed, self-locking nose.
 - Stainless steel.
 - Presentation: fine polished.
 - Length: 150 mm.
- Weight: 23 g.

▣ 154 Tweezers straight model - power nose



- Power, rigid, grooved nose for wiring.
 - Stainless steel.
 - Presentation: fine polished.
 - Length: 155 mm.
- Weight: 30 g.

PVC sheath series

▣ 149.Y PVC sheath tweezers straight model



- Length: 155 mm.
- Weight: 25 g.

▣ 152.Y PVC sheath tweezers model angled at 45°



- Length: 150 mm.
- Weight: 25 g.

▣ 146.1Y PVC sheath tweezers model for picking components - straight shank



- Diameter 2.5 to 4 mm, in the axis of the tweezers.
 - Length: 140 mm.
- Weight: 25 g.

High precision series

▣ 141.11 Tweezers «high precision» straight very pointy model



- Extra-flexible, smooth very pointed nose.
 - Length: 110 mm.
- Weight: 13 g.

▣ 141.12 «High precision» tweezers straight model



- Extra-flexible, smooth very pointed nose.
 - Length: 130 mm.
- Weight: 14 g.

▣ **146.2Y** PVC sheath tweezers model for picking components - perpendicular shank



- Diameter 2.5 to 4 mm, perpendicular to the tweezers axis.
- Length: 140 mm.
- Weight: 25 g.

▣ **142.1** «High precision» tweezers straight model - cleared nose



- Extra-flexible, smooth very pointed nose.
- Length: 112 mm.
- Weight: 13 g.

▣ **142.2** «High precision» tweezers 15° angled model - cleared nose



- Extra-flexible, smooth very pointed nose.
- Length: 117 mm.
- Weight: 15 g.

▣ **143** «High precision» tweezers curved straight model



- Extra-flexible, smooth very pointed nose.
- Length: 114 mm.
- Weight: 14 g.

▣ **144** Tweezers «high precision» straight model - very slim nose



- Fine rounded, smooth nose.
- Length: 120 mm.
- Weight: 17 g.

▣ **145** Tweezers «high precision» straight model - wide flat nose



- Smooth nose.
- Nose width: 7 mm.
- Length: 123 mm.
- Weight: 14 g.

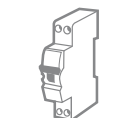

156 «High precision» tweezers straight power model



- Thin grooved nose.
- Length: 110 mm.
- Weight: 15 g.

Special tweezers

150.P1 Plastic tweezers straight model - sterilizable



- Material: polypropylene, sterilizable 180 °C max.
- Length: 125 mm.
- Weight: 6 g.

150.P - Plastic tweezers straight models - anti-static



- Material: glass fiber reinforced (20%) anti-static polyamide.
- Anti-magnetic.
- Resistant to acid.
- Resistant to temperatures up to 200 °C.
- Precision, smooth nose.
- 150.P10: wide straight nose.
- 150.P11: thin angled nose.

➤	L [mm]	ΔΔ [g]
150.P10	120	5
150.P11	120	5

139 Tweezers cutting model for extra-thin wires



- Carbon alloy steel for perfect cutting edges.
- Very high precision cut.
- Presentation: fine polished.
- Nose tip width: 10 mm.
- Length: 110 mm.
- Weight: 27 g.

Sets of Tweezers

147 - Sets of tweezers



- The sets are presented in plastic case.

➤	Content set	Dimension [mm]	ΔΔ [g]
147.J5	Set of 5 standard tweezers: 149 - 150 - 151 - 152 - 140.AA	178 x 91 x 24	240
147.J6	Set of 8 standard and sheathed tweezers: 150 - 151 - 153 - 149.Y - 152.Y - 146.1Y - 146.2Y - 140.AA	205 x 130 x 31	410
147.J7	Set of 7 "high precision" tweezers: 140.AA - 141.14 - 142.1 - 142.2 - 143 - 144 - 145	205 x 130 x 31	335

Circlip® pliers

■ 470.MT Set for inside and outside circlips®



Comprising:

- 1 outside circlips pliers 467.PMT.
- 1 inside circlips pliers 469.PMT.
- These pliers include a spring-assisted opening and a screw-stop adjustment to avoid deforming the circlips and ensure precise fitting or removal.
- 6 sets of straight and angled tips.
- 1 key.
- Presentation: chrome polished. PVC sheathed branches.
- Supplied in plastic case: 285 x 142 x 46 mm.

Weight: 600 g.

Truarc® pliers

■ 1813 Tool for Truarc® rings

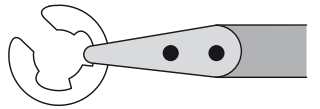
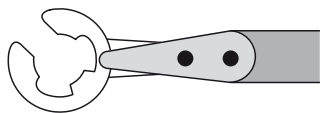

- It allows to fit and remove Truarc rings, maximum diameter 6 mm, in difficult access locations.
- Length: 170 mm.

Weight: 19 g.

Scissors

■ 841.1 «Stubby» scissors



- For high precision cutting.
- Left/right hand model.
- Presentation: chrome polish, PVC sheathed branches.
- Length: 110 mm. Blade length: 24 mm.

Weight: 27 g.

■ 841.2 Long pointed blade scissors



- Left/right hand multi-purpose model.
- Presentation: chrome polish, PVC sheathed branches.
- Length: 120 mm. Blade length: 42 mm.

Weight: 36 g.

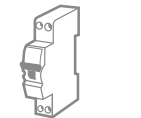
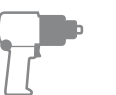
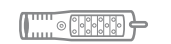

Cutter

▣ 845.1 Interchangeable-blade safety knife



- For precise and neat cutting.
 - Blades perfectly held.
 - 2 types of blades.
 - Length: 150 mm.
 - Knife supplied with 10 L1-type blades.
- Weight: 15 g.
- Spare blades:
 - 845.L1: Set of 10 straight thin blades.
 - 845.L2: Set of 10 offset blades.

Hacksaw frame

▣ 607.MT Micro-Tech® hacksaw frame



- Well in hand. Very light body in lacquered Zamak; for small work on plastic, wood, metal.
 - Supplied with a 150 mm blade.
 - Overall length: 262 mm.
- Weight: 140 g.

▣ 608.L12 Saw blades

- Set of 5 blades 12 teeth/cm
- Weight: 20g

Various tools

▣ 1817 Clamp tool-holder



- Each end has a double clamp and a chuck.
 - Can be fitted with any cylindrical tool diameter 0.5 to 3.5 mm.
 - Length: 110 mm.
- Weight: 35 g.

▣ 1150.MT Micro-Tech® swivel-base vice

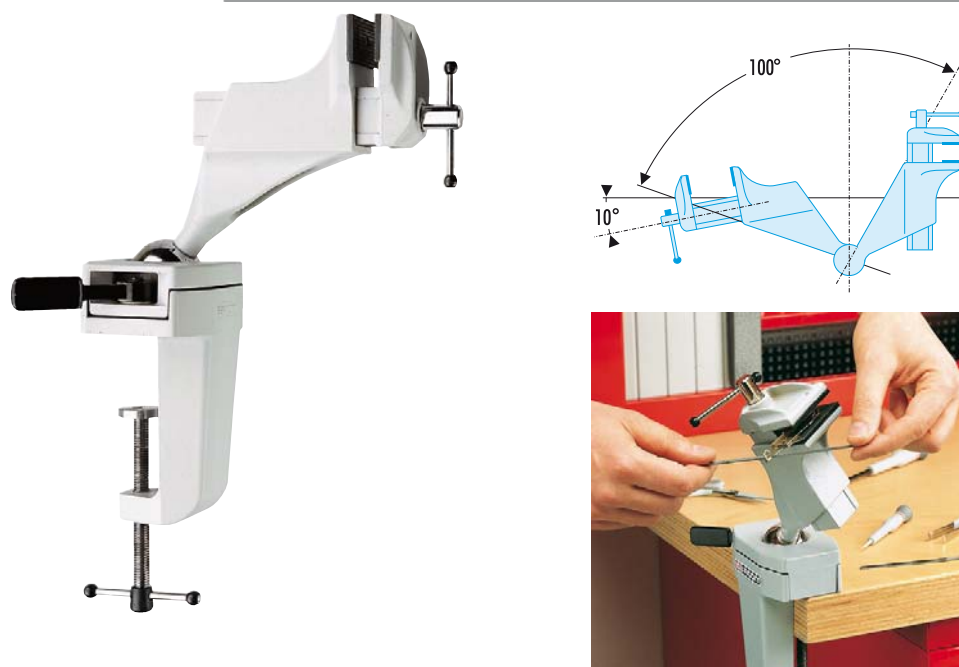

- Designed for a comfortable work position ensuring high precision.
 - Instant locking lever on swivel base.
 - Fastener for firm fastening on a support of 80 mm thick max.
 - Jaws in glued plastic, width: 50 mm.
 - Max opening: 70 mm.
 - Max depth: 38 mm.
- Weight: 1400 g.

▣ 372 Pen oil can



- For precise greasing, drop by drop, by pressing the button.
 - Level visible.
 - Protection cap.
 - Metal fastener for clipping in the pocket.
 - Spread: 5 cm³.
- Weight: 20 g.

▣ 825.MT Nut fitter



- Micro-Tech® screwdriver handle with swivel base.
 - Allows to fit a hex nut 3 to 14 mm on flat.
 - Blade length: 150 mm. Total length: 240 mm.
 - Blade anti-corrosion treated.
- Weight: 60 g.

▣ 835A Spring hook



- With pusher hook and traction hook.
 - Presentation: chromed, sheathed.
 - Length: 200 mm.
- Weight: 13 g.

▣ 835.1 Separator



- With a fork and tip diameter 0.5 mm.
 - Presentation: chromed, sheathed.
 - Length: 210 mm.
- Weight: 15 g.

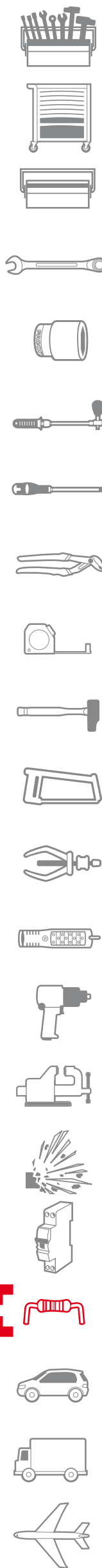

836 Pen light



- Body in aluminum tube.
 - Length: 137mm.
 - Tube diameter: 14mm.
 - Runs on two AAA LR03 (1.5 volt) batteries not supplied.
 - Adjustable focus.
 - Supplied with wrist strap.
 - Spare lamp reference: 836.AMP.
- Weight: 29 g.

1830 - Brushes



- For cleaning, removing dust.
- 1830.1: Extra-soft silk brush.
 1830.3: Etching brush: nylon outside, metallic wires at the centre.
 1830.4: Soft nylon brush.

FACOM	L [mm]	L1 [mm]	ΔΔ [g]
1830.1	190	-	17
1830.3	190	50	35
1830.4	230	100	30

HT.3 Set of 2 tuning screwdrivers for slotted head screw



- Screwdriver dimensions:
 - HT.2x2.4: 2 and 2.4 mm.
 - HT.3x4: 3 and 4 mm.
 - Screwdrivers available per unit.
 - Supplied in roll.
- Weight: 26 g.

826.0 Mechanical retriever with 4 claws



- To recover small flat parts with max diameter 30 mm.
 - Presentation: nickel-plated.
- Weight: 20 g.

827 - Extra-thin flexible magnetic retrievers

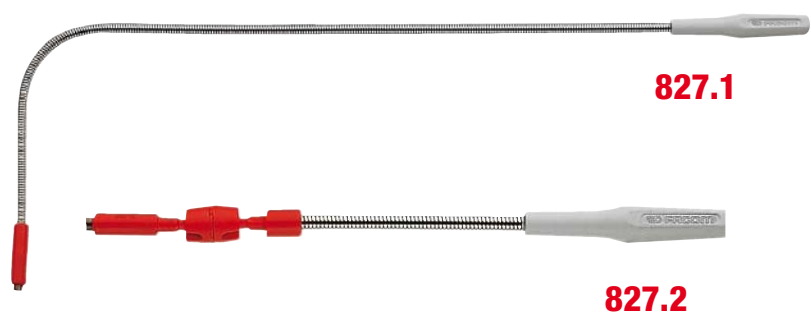

- 827.1: flexible and long model head diameter 7 mm.
- 827.2: ball joint model head diameter 8 mm.
- Max lifted weight: 120 g.

827	L [mm]	ΔΔ [g]
827.1	530	80
827.2	210	26

Flexible magnetic retriever



- Magnet diameter: 12 mm.
- Max lifted weight: 850 g.
- Length: 570 mm.
- Weight: 220 g.

827	ΔΔ [g]
827.M	80

Flexible magnetic retriever - high power



- Powerful magnet (3 kg).
- Magnetic flux conductor prevents sticking to sides.
- Length 560 mm, adjustable stiffness.
- Magnet diameter: 20 mm.
- Weight: 130 g.

827	ΔΔ [g]
827B	30

828 «Luminous» flexible magnetic retriever

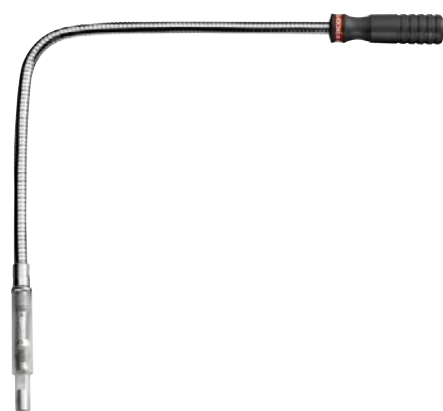

- Magnet diameter: 15 mm.
- Max lifted weight: 1.2 kg.
- Supplied with LR1 battery.
- Length: 590 mm.
- Weight: 220 g.

826.1 Flexible mechanical retriever 460 mm

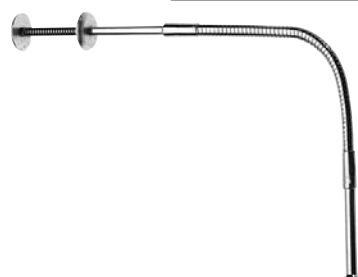

- Max nose opening diameter: 29 mm.
- Length: 460 mm.
- Weight: 200 g.

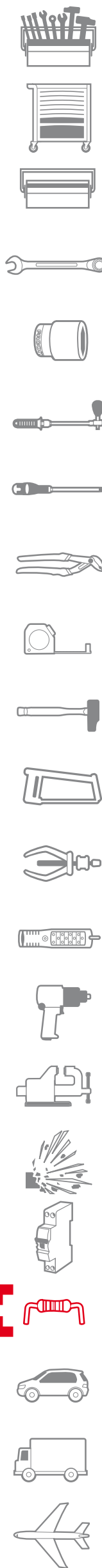

826.2 Flexible mechanical retriever 1000 mm

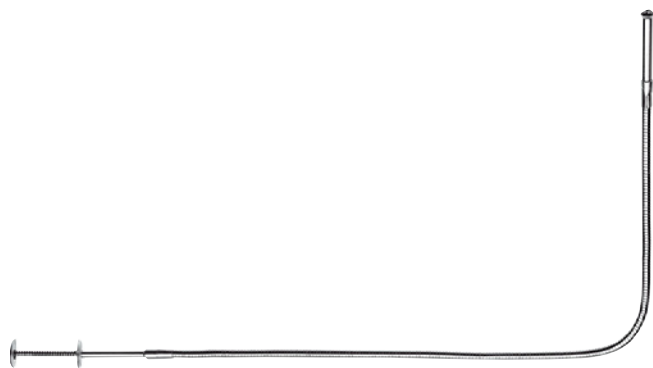

- Max nose opening diameter: 29 mm.
- Length: 1000 mm.
- Weight: 400 g.

834 - Inspection mirrors

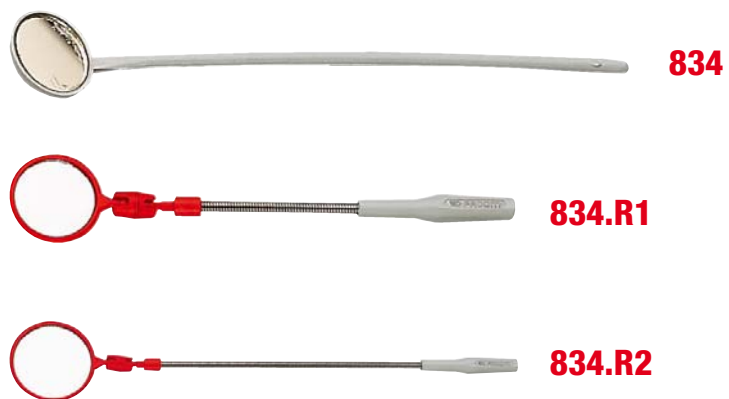

- Mirror crimped on plastic.
- 834: one-piece rigid.
- 834.R1: jointed and flexible.
- 834.R2: jointed and flexible.

834	d [mm]	L [mm]	$\Delta\Delta$ [g]
834	24	175	4
834.R1	36	210	13
834.R2	55	360	40

834B.RT Inspection mirror



- Mirror in scratch resistant glass, available as spare parts.
- Metallic strapping around the glass for better protection.
- Joint easily adjustable, or even locked, by screw.
- Solvent resistant plastic handle: Skydroll, gasoil...
- Max length 850 mm.
- Mirror diameter 55 mm.
- Weight: 80 g.

- 834B.RT01: Spare mirror.

Flexible orientable mirror

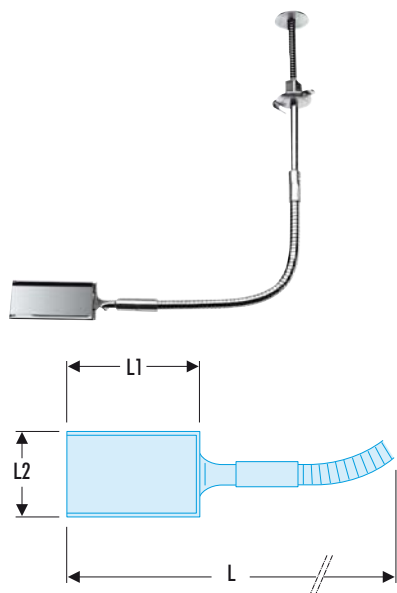

- The mirror is turned by pressing the button on the handle.
- Weight: 225 g.

829	L [mm]	L1 [mm]	L2 [mm]	$\Delta\Delta$ [g]
829	495	70	45	225

▣ **1802A.N** Black mini wire-holder



- Insulated model with 2 claws, flexible tube diameter 3 mm.
- Length: 130 mm.
- Weight: 10 g.

▣ **1802A.R** Red mini wire-holder



- Insulated model with 2 claws, flexible tube diameter 3 mm.
- Length: 130 mm.
- Weight: 10 g.

▣ **1803A.N** Black contact tip



- Insulated model, brass tip and socket diameter 4 mm for 1804B chord.
- Supplied with protection cap.
- Weight: 15 g.

▣ **1803A.R** Red contact tip



- Insulated model, brass tip and socket diameter 4 mm for 1804B chord.
- Supplied with protection cap.
- Weight: 15 g.

▣ **1804B.N** Black connection cable



- Very flexible insulated model with retractable protection.
- 2 connectors diameter 4 mm for contact tip and mini-wire-holder.
- Length: 2.1 m.
- Weight: 50 g.

▣ **1804B.R** Red connection cable



- Very flexible insulated model with retractable protection.
- 2 connectors diameter 4 mm for contact tip and mini-wire-holder.
- Length: 2.1 m.
- Weight: 50 g.

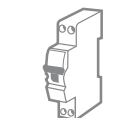

Thermoregulated Soldering Units

▣ 1003B.E Anti-static digital welder 68 watts



- Ultra fast heating time: 9 s.
- Automatic standby mode for less power consumption and automatic power off.
- Super compact station.
- Temperature calibration possible for higher accuracy. Reduction of temperature of the display and that of the soldering iron tip.
- Setpoint temperature: 360 °C / 680 °F.
- Temperature range: 150 to 450 °C, 300 to 842 °F.
- Stability: + or - 2°C.
- Power: 68 W.
- Supply voltage: 220 - 240 V ~ 50/60 Hz 110 - 120 V ~ 50/60 Hz.
- Dimensions (L x H x D): 145 mm x 80 mm x 103 mm.
- Weight: 1050 g.

• Soldering iron 1003B.68E:
Dimensions: L x handle Ø / 175 mm x 12 mm.
Cable length: 950mm.
Weight: 30 g (without cable).

• Holder:
Dimensions (L x H x D): 140 mm x 80 mm x 80 mm.
Weight: 200 g.

Spare iron tips 1003B.68E:
- 1003B.P1: thin pen tip (0.4mm).
- 1003B.P2: large pen tip (1.0mm).
- 1003B.P3: screwdriver tip (1.6mm).

▣ BV.21-10 Soldering iron stand



- Stores a soldering iron type Facom 1230 or equivalent immediately after welding works. It can be transported safely in a maintenance case. The insulating part does not contain any asbestos.
- 180 x diameter 35 mm.
- Weight: 210 g.

1003B.68E Electronic soldering iron



- Power: 68 W.
- Supply voltage: 220 - 240 V ~ 50/60 Hz 110 - 120 V ~ 50/60 Hz.
- Dimensions: L x handle \varnothing / 175 mm x 12 mm.
Cable length: 950mm.
Weight: 30 g.

Electronic irons

1230 - 203 volt electronic soldering irons



- Range from 15W to 40W.
- High efficiency irons thanks to inside heating of the tip.
- Supplied with iron stand.

Spare tips:

- For iron 1230.25: pointy tip 1230.25P2
- For irons 1230.30 and 1230.40: pointed tip 1230.30P2 - screwdriver tip 1230.30P3

	L [mm]	Heating time [mn]	Voltage \ Volt	Rating [W]	Peak temp \pm 10%	$\Delta\Delta$ [g]
1230.25	240	1	230	25	450	34
1230.30	240	2	230	30	420	80
1230.40	240	2	230	40	420	80

1116B.BW Bi-watt iron 20-40 for electronic



- Power supply: 230 V.
- Double insulation.
- Iron ideal for electric and electronic maintenance.
- In normal heating: 20 W for minor soldering.
- Additional power: 40 W by pressing the button.
- PVC 2-conductor cable (2 x 0.75). Length: 1.2 m.
- European connector 10 A.
- Supplied with tip 1112.30P1.

Weight: 145 g.

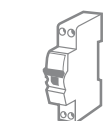

Instant soldering irons

848B.100 Instant-heat 100 W - 230 V soldering iron

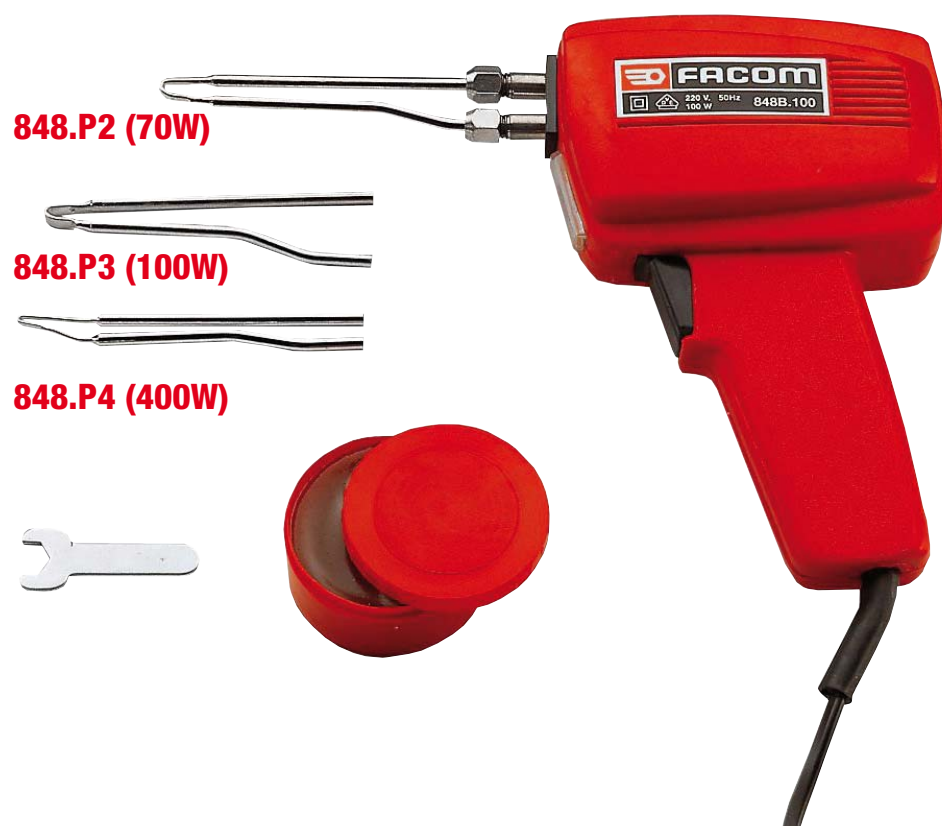

- Double insulation.
- Ready to run (5 s) once the trigger pressed.
- When the trigger is released, the tip cools down instantly.
- Useful for punctual and intermittent works, handy in maintenance case.
- Lighting device effective and well protected.
- Supplied with 3 stainless steel tips for power 40, 70 and 100 W, a tightening key, a coil of tin and a 1 pot of etching paste in a polystyrene case.
- PVC 2-conductor cable (2 x 0.75 mm²). Length: 1.25 m.
- Connector with 2 poles.
- Length: 270 mm.
- Weight: 1000 g.

- Spare tip: 848.100P2

High power soldering irons

947A - High power irons - 230 V



- Power range from 50 to 400 W.
- Supplied with an angled tip.
- Very high yield with excellent robustness.
- Shape designed for difficult access.
- Shiny copper tips.
- Stainless steel heating body tube.
- These irons meet the requirements of the EN 60335 - 2 - 45 standard.
- Tips:
 - 947.50P1 diam. 6 mm.
 - 947.80P1 diam. 8 mm.
 - 947.100P1 diam. 10 mm.
 - 947.2000P1 diam. 15 mm.
 - 947.300P1 diam. 20 mm.

FACOM	L [mm]	Rating [W]	Peak	Peak temp ± 10%	ΔΔ [g]
947.50	266	50	947.50P1	390	290
947.80	295	80	947.80P1	400	330
947A.100	300	100	947.100P1	420	440
947A.200	315	200	947.200P1	450	675
947A.300	320	300	947.300P1	470	960
947A.400	320	400	947.300P1	500	960

Gas soldering iron

GAS SOLDERING IRON

ONE TOOL - FOUR FUNCTIONS

- ❶ Soldering (Electronics, etc.).
- ❷ Hot fitting (Heat-shrinkable tubing, etc.).
- ❸ Blowtorch
- ❹ Hot-cutting (Plastic, rubber, etc.).

- Rechargeable butane gas burner.
- Integral ignition system (Piezo-electric system).
- Adjustable power setting.
- Safe: The cap on the end of the nozzle keeps the gas control valve closed.



❑ 1075.G Self-sufficient soldering iron



- Power equivalent to 75 watts.
 - Flow and power adjustable, operating time 45 mn at max power.
 - Max temperature 1300°C.
 - Lighting by piezo.
 - Heating time: 40 sec.
 - Rechargeable with butane gas (iron supplied empty).
 - 1075.G1: spare tip.
 - 1075.G2: hot air nozzle.
 - 1075.G3: flame nozzle.
 - 1075.G4: knife.
- Weight: 275 g.

Soldering accessories

❑ 839 - Desoldering pumps



- Double gasket: one provides cleaning, allowing the other to guarantee perfect sealing.
- Sets of 5 spare tips:
 - 839.E1J5: standard, white.
 - 839.EJ5: thin, black, antistatic.

❏	Bits	L [mm]	ΔΔ [g]
839A	3,2	190	75
839A.0	2	165	36
839A.1	2	200	78
839A.7	2	195	78

❑ 1130.1 Desoldering braid



- This braid provides remarkable absorbing qualities. It avoids thermal shock for delicate components.
 - Width: 1.6 mm.
 - Length: 1.6 m.
- Weight: 15 g.

IDEMCO

W : www.idemcosb.com.my
E : idemco@idemcosb.com.my
T : +6 03-7781 7973