

Makita®

IDEMCO



2023/24

ACCESSORIES CATALOGUE

Safety



Wear Eye Protection



Wear Ear Protection



Wear A Mask



Wear Protective Gloves



Wear Protective Shoes



Remove Plug From Socket

Materials

Masonry



Reinforced concrete



Concrete



Aerated concrete



Brick



Soft brick



Stone



Limestone



Marble



Granite

Wood



Wood



Wood with nails



Laminate board



Plywood



Chipboard



MDF

Metal



Metal



Sheet metal



Non-ferrous metals



Aluminum



Stainless steel



Cast iron

Other Materials



Glass fibre reinforced plastic, epoxy



Glass



Plastic



Ceramic tiles



Soft Tile



Fiber cement board



Plaster board



Epoxy



Cardboard



Cork



Asphalt



Rubber



Leather



Ice

Drilling (Wood/Metal) 20



Drilling (Masonry) 41



Fastening 58



Drill and Screw Bit Sets 67



Cutting 70



Jigsaw / Reciprosawing 83



Brushing 94



Bonded Abrasive 96



Coated Abrasive 105



Multi Tool 115



Diamond 127



Planing / Routing 140



OPE 146



Cleaning / Vacuum System 166



Miscellaneous 182





















Blue Collection 227

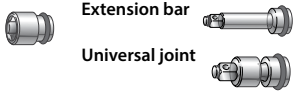































System Charts

Screwing/Drilling

<p>Drill Angle Drill Driver Drill</p> 	<p>Fastening P.58</p> <p>Screw bit Socket bit</p> 
	<p>Drilling (Wood/Metal) P.20</p> <p>Drill bit</p>  <p>Step drill bit & Countersink bit</p>  <p>Hole saw</p> 
	<p>Brushing P.95</p> <p>Nylon brush & Wire brush</p> 
<p>Hammer Driver Drill Hammer Drill</p> 	<p>Drilling (Masonry) P.42</p> <p>Masonry bit with straight shank (Tungsten carbide-tipped bit)</p> 
	<p>Fastening P.61</p> <p>Screw bit Socket bit</p> 
<p>Drywall Screwdriver Screwdriver</p> 	<p>Drilling (Wood/Metal) P.24</p> <p>Drill bit with 1/4" Hex shank</p> 
	<p>Drilling (Masonry) P.43</p> <p>Masonry Bit with 1/4" Hex shank</p> 
<p>Impact Driver</p> 	<p>Fastening P.65</p> <p>Socket Extension bar Universal joint</p>  <p>Screw bit Bit adapter assembly</p> 
	<p>Fastening P.61</p> <p>Screw bit</p> 
<p>Impact Wrench</p> 	
<p>Auto Feed Screwdriver</p> 	
<p>Power Mixer</p> 	<p>Miscellaneous P.190</p> <p>Mixing blade</p> 

Hammer drilling/Chiselling

<p>Combination Hammer (3 Mode)</p> 	<p>Drilling (Wood/Metal) P.20</p> <p>Drill bit</p>  <p>Step drill bit & Countersink bit</p>  <p>Hole saw</p> 
	<p>Diamond P.139</p> <p>Diamond core bit (Dry type)</p> 
	<p>Drilling (Masonry) P.51-57</p> <p>Tungsten carbide-tipped bit</p>  <p>Bull point</p>  <p>Cold chisel</p>  <p>Grooving chisel</p>  <p>Scaling chisel</p>  <p>Scraper assembly 100 (SDS-PLUS only)</p>  <p>Clay spade</p>  <p>Bushing tool</p>  <p>Rammer</p>  <p>Ground rod adapter</p> 
<p>Rotary Hammer (2 Mode SDS PLUS Model)</p> 	
<p>Demolition Hammer</p> 	
<p>Power Scraper</p> 	
<p>Electric Breaker</p> 	
<p>Cutting</p>	
<p>Cutter</p> 	<p>Diamond P.127</p> <p>Diamond wheel</p> 
<p>Angle Cutter</p> 	<p>Bonded Abrasive P.96</p> <p>Cut-off wheel</p> 
<p>Portable Cut-off</p> 	
<p>Metal Cutter</p> 	<p>Cutting P.70</p> <p>Carbide-tipped saw blade for Metal</p>  <p>Grooving TCT Saw Blade</p> 
<p>Aluminum Groove Cutter</p> 	
<p>Portable Band Saw</p> 	<p>Jigsaw / Reciprosawing P.93</p> <p>Band saw blade</p> 

System Charts

Grinding/Sanding/Polishing

Angle Grinder



Bonded Abrasive P.96



Coated Abrasive P.105

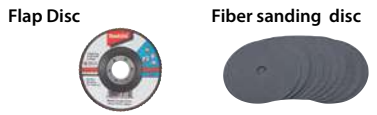

Brushing P.94



Diamond P.127

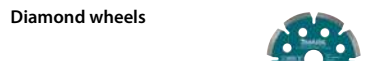

Die Grinder



Bonded Abrasive P.104

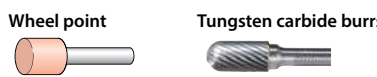

Disc Sander



Coated Abrasive P.105



Belt Sander



Finishing Sander

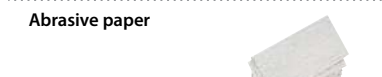

Random Orbit Sander



Polisher



Coated Abrasive P.105



Stone Polisher



Wheel Sander



Brushing P.94

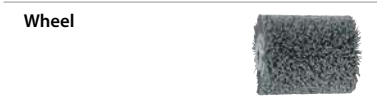

Bench Grinder Straight Grinder



Bonded Abrasive P.96



Multifunction

Multi Tool



Multi Tool P.115

Multi Tool Accessories



Sawing

Slide Compound Miter Saw
Circular Saw
Table Saw



Cutting P.70

Saw blade



Jig saw



Jigsaw / Reciprosawing P.83

Jig saw blade



Reciprosaw



Reciprosaw blade



Band saw



Band saw blade



Milling/Planing

Planer



Planing / Routering P.140

Planer blade



Mini planer blade



Trimmer Router



Router bit



Concrete Planer



Diamond P.138

Offset diamond wheel



Outdoor Power Equipment



P.146

Brushcutter blades



Chain blade

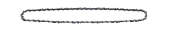

Shear blade



Nozzle



Nylon cutting head

Miscellaneous



Hand Tool, Pouches & Holders P.182



Pneumatic Tool P.189

Nails



Staple

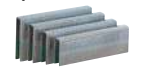

Ideal for Cordless Tool Accessories



What is Ideal for DC tool Accessories ?

Provides the greatest performance on DC tools!

Higher speed, more work amount on a single full battery charge and a nice sense of use.* Here are the parties which give you the greatest performance on your MAKITA DC tools. You can find recommended accessories for DC tools with DC tool icons with an emphasized battery symbol. Try and see MAKITA's leading-edge technology.

*Features may vary by item.





TCT saw blade EFFICUT series

EFFICUT

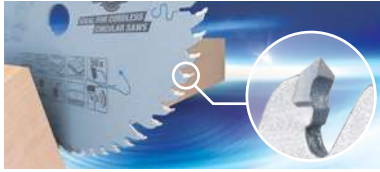

Efficient Sharp Tip's Top Angle



Efficient Curved Tip's Body



Efficient Slimmed Bottom



The amount of cutting per 1 charge

100

140% UP

240

EFFICUT Composite decking

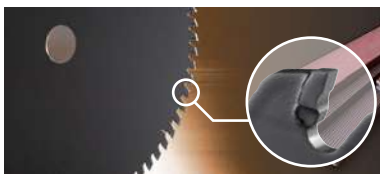

Efficient Curved Tip's Body



Efficient Slimmed Bottom



The amount of cutting per 1 charge

100

30% UP

130

EFFICUT Metal



Strong and least chipping



Release swarf smoothly



Superior in straight cutting

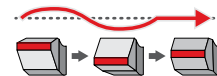

The amount of cutting per 1 charge

100

60% UP

160

EFFICUT Aluminum



Strong and least chipping



Reduce cutting resistance



Superior in straight cutting

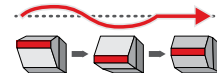

Release swarf smoothly



The amount of cutting per 1 charge

100

40% UP

140



Diamond wheel for concrete

Specialized for 9inch DC Power Cutter

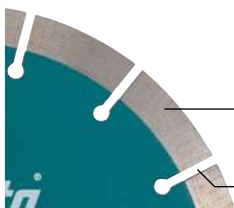

To reduce the cutting load, diamond grain size is designed small.

The narrower slits reduce dragging work pieces.

The amount of cutting per 1 charge

100

65% UP

165

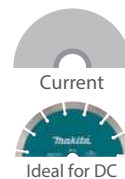

Ideal for DC

NEW Cut-off wheel for Power cutter/ Metal / Ideal for Cordless Power cutter

Specialized for 14inch DC Power Cutter



Ideal blend of abrasive grain and bond for Cordless power cutter.

The amount of cutting per 1 charge

100

10% UP

110

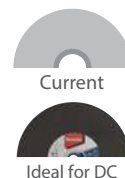

Ideal for DC



Thin cut-off wheel

0.8mm thickness for fast cutting

Thinner thickness

0.8mm thinner thickness brings ... fast cutting / reduction of cutting resistance / less burr of materials / less dust of materials

The amount of cutting per 1 charge

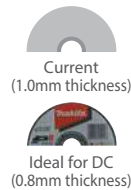

2in1 grinding wheel

Cutting and deburring are possible in one disc

Specialized cutting work

Thanks to "SA"grid and 2.2mm thinner thickness, it enables you to cut fast and deburring safety.

The amount of cutting per 1 charge



Flexible grinding wheel

Low vibration and no need back-up pad

Shock absorbed structure

Added shock absorbing material. You can feel overwhelmingly low vibration. Grinding speed is also faster because of its flexibility. It can touch materials more efficiency.

The amount of cutting per 1 charge

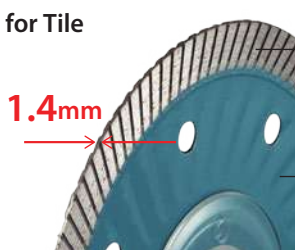
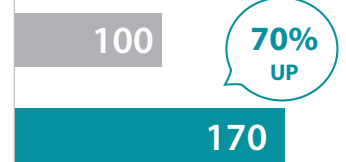
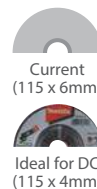

Thin diamond wheel

Smooth & light cutting

Thinner thickness & enough strength

1.4mm thickness able to get smooth and light cutting.

Corrugated Rim increases wheel tension and reduces vibration during the cut.

The amount of cutting per 1 charge

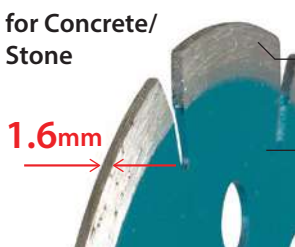
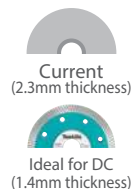

Specialized cutting work

This blade is designed as 1.6mm. So smooth and light cutting is available.

It was lightened by punching the body. It is also reduce the load on the battery and increased the cutting distance per 1 battery charge.

The amount of cutting per 1 charge

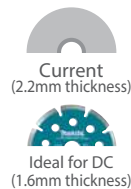

Abrasive Cut-off wheel for metal stud

Specialized for 14inch DC Portable Cut-off

Thinner blade & the optimum bonding

2.5mm thickness blade for smooth and fast cutting. The optimum bonding for fast cutting and longer life.

The amount of cutting per 1 charge

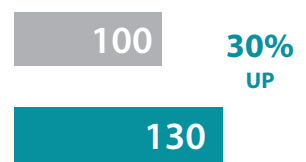
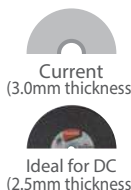



Impact PREMIER



High Precision Screw Fitting.

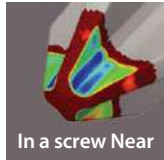

Double Torsion for High Durability.

New Steel is Used. Supports High Torque.

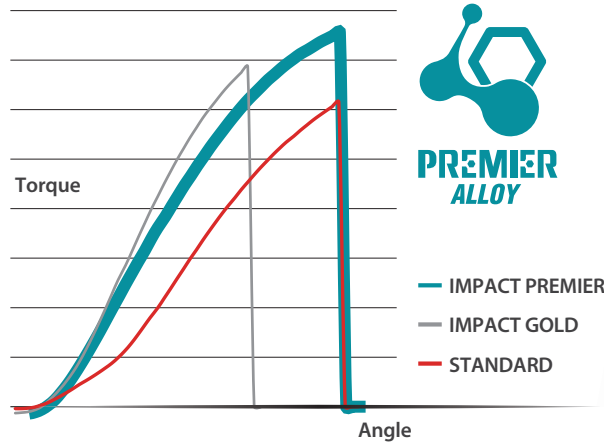

Four-leaf Nylon cord Four-Leaf Line

Low noise and energy saving



Round

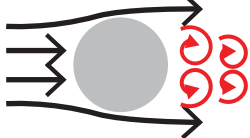

Four-leaf



Four-leaf shape makes small vortex and realizes low noise and energy saving feature thanks to less air resistance.

The amount of cutting per 1 charge

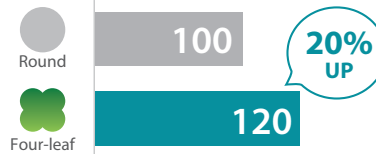

Noise

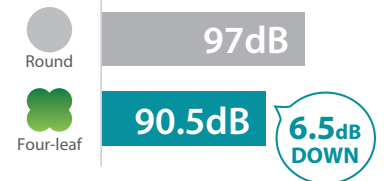

80 series saw chain

1. Optimum cutter shape for smooth cutting

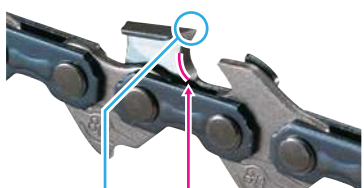

Sharp top angle

Deep-curved body

2. Short pitch for less vibration

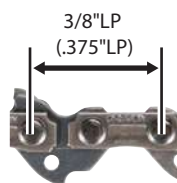

Current (90PX)

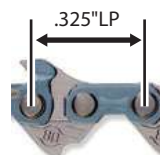

Ideal for DC (80series)

The amount of cutting per 1 charge

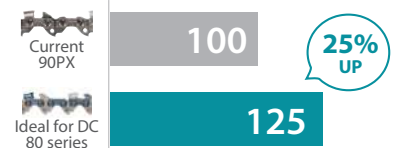

Vibration

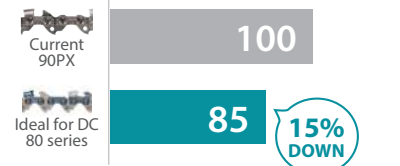

Tool ◀▶ Battery ◀▶ Battery Charger
Digital communication

XGT is a new system with its own tools, batteries, and chargers. A combination of innovative tool design and higher output batteries provide a genuine solution for high demand industrial users.

Optimum power supply system and Optimum charging system

The XGT range of tools and batteries come with a built-in program, providing digital communication between the battery and tool. Allowing not only for the battery to talk with tool but also the tool to talk to the battery. Battery technology and motor engineering that work together for optimum performance.



Optimum charging system

Auto maintenance system with two cooling fans for providing more optimum fast charging

Built Tough

High durability specifications specially designed for 40Vmax Li-Ion batteries

4-LED fuel gauge indicator



Terminal short-circuit prevention structure
The protection wall is provided between terminals against water and dust.

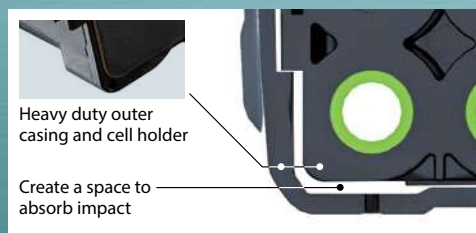

Heavy duty outer casing and cell holder
Create a space to absorb impact

Shock absorption structure

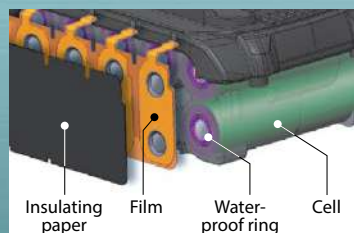

Waterproof Triple-layer Structure
prevents cell failure due to water and dust.

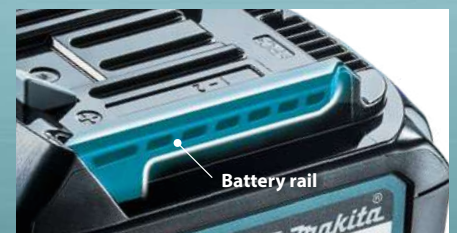

High Rigidity Battery Rails
Durable slide in battery rail that holds the battery and the tools firmly and securely to withstand high power products

40Vmax mechanism movie

This movie was filmed in Japan.
Models and specs may vary by country.



Rapid Optimum Charging System

It is necessary to cool down before start charging when the battery temperature is high.
Built-in fan circulates air through the battery before start charging and during the charging process to cool the battery for faster charge time.

The Makita Rapid Optimum Charger communicates with the battery's built-in chip throughout the charging process to optimize battery life by actively controlling current, voltage and temperature.

The optimum charging system
Forced air cooling

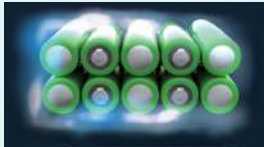

Fast charging



General charging method
Natural heat dissipation

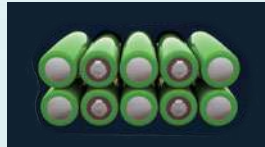

Waiting time for charging



The optimum charging system

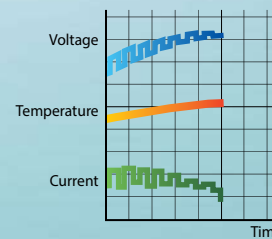

General charging method

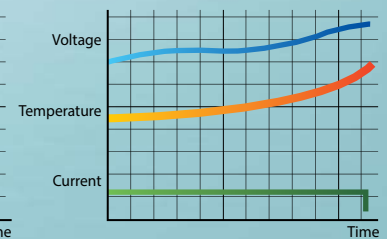

Battery Protection Function

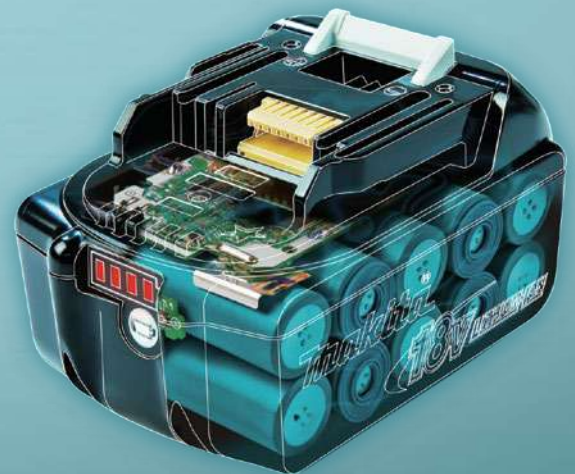
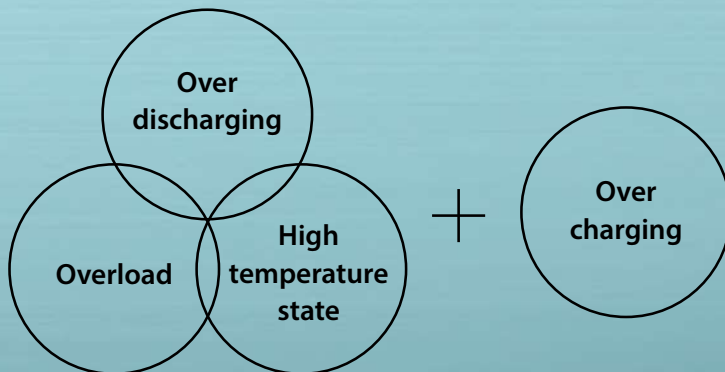

This function is communication technology that allows the tool and battery to monitor conditions and exchange data in real time to protect against Overload, Over-Discharge and Overheating.

Firm Holding

Multi-contact terminals reduce electrical resistance and increase connection stability withstanding against vibration, and ultimately ensures Stable current supply to the tool.

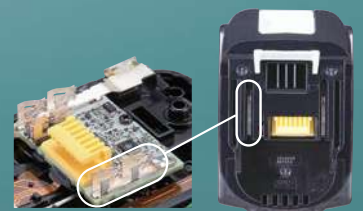

Anytime Charge
No Memory Effect
No discharging required



Shock Absorbing
Heavy Duty Pack



Li-ion Battery & Charger Time Reference, Compatibility Chart

40Vmax 18V		Fast Charging DC40RA (191E08-6) DC40RB* (191N14-5)	DC40RC (191M92-9)	Fast Charging DC40RA + ADP10 (191C11-5) Compatible with LXT Li-Ion batteries	DC40RC + ADP10 (191C11-5) Compatible with LXT Li-Ion batteries	Fast Charging DC18RC (195586-8) 110V - (195582-6) DC18RD* (196934-4) DC18RE** (198446-3)	DC18SD (194534-4) DC18SH* DC18SE (Automotive) (194621-9)	
40Vmax Lithium-ion XGT	8.0Ah BL4080F (191X65-8)	76min.	170min.	-	-	-	-	
	5.0Ah BL4050F (191L47-8)	50min.	85min.	-	-	-	-	
	4.0Ah BL4040F (191ON6-8) BL4040 (191B26-6)	45min.	67min.	-	-	-	-	
	2.5Ah BL4025 (191B36-3)	28min.	38min.	-	-	-	-	
	2.0Ah BL4020 (191L29-0)	22min.	30min.	-	-	-	-	
18V Lithium-ion LXT	6.0Ah BL1860B (197422-4)	-	-	40min.	85min.	55min.	130min.	
	5.0Ah BL1850B (197280-8)	-	-	35min.	70min.	45min.	110min.	
	4.0Ah BL1840B (197265-4)	-	-	29min.	58min.	36min.	90min.	
	3.0Ah BL1830B (197599-5)	-	-	22min.	42min.	22min.	60min.	
	2.0Ah BL1820B (197254-9)	-	-	24min.	33min.	24min.	45min.	
	1.5Ah BL1815N (196449-1)	-	-	15min.	22min.	15min.	30min.	
12Vmax Lithium-ion CXT	4.0Ah BL1041B (197406-2)	60min.	130min.	40Vmax Lithium-ion 18V x2 Lithium-ion	360min.	40Vmax Lithium-ion 18V x2 Lithium-ion 18V Lithium-ion	Powered by up to four 18V LXT Batteries	
	2.0Ah BL1021B (197396-9)	30min.	70min.					
	1.5Ah BL1016 (197393-5)	22min.	50min.					
64Vmax Lithium-ion	10.0Ah BL64100 (191Y69-6)	300min.	10.8V Lithium-ion	1.3Ah BL1013 (196066-7)	50min.	18V Lithium-ion	1.5Ah BL1815G (198186-3) BL1415G (198192-8)	70min.
	4.0Ah BL6440 (191R06-8)	120min.	7.2V Lithium-ion	1.5Ah BL0715 (198000-3)	35min.	14.4V Lithium-ion	2.0Ah BL1820G (191N69-0)	90min.

* DC40RB / DC18RD / DC18SH: Two Port Multi Fast Charger ** DC18RE: CXT & LXT Dual port Fast Charger

MAKPAC Power Source Kit



QADPSKG1 (191V23-2)	Fast Charger (DC40RC), 2X40Vmax - 2.0Ah Batteries (BL4020), Makpac	
QAEPSKG1 (191V31-3)	Fast Charger (DC40RC), 2X40Vmax - 2.5Ah Batteries (BL4025), Makpac	
MKP1G001 (191J85-8)	Rapid Charger (DC40RA), 2X40Vmax - 2.5Ah Batteries (BL4025), Makpac	
MKP1G002 (191K01-6)	Rapid Charger (DC40RA), 2X40Vmax - 4.0Ah Batteries (BL4040), Makpac	
MKPPSKG2 (191V42-8)	Rapid Charger (DC40RA), 2X40Vmax - 5.0Ah Batteries (BL4050F), Makpac	
QAAPSKG3 (191U06-6)	Dual Port Multi Rapid Charger (DC40RB), 2X40Vmax - 4.0Ah Batteries (BL4040), Makpac	
QABPSKG3 (191U20-2)	Dual Port Multi Rapid Charger (DC40RB), 2X40Vmax - 5.0Ah Batteries (BL4050F), Makpac	
QAPSKG3 (1910A2-5)	Dual Port Multi Rapid Charger (DC40RB), 2X40Vmax - 8.0Ah Batteries (BL4080F), Makpac	
QACPSKG3 (191U34-1)	Dual Port Multi Rapid Charger (DC40RB), 4X40Vmax - 4.0Ah Batteries (BL4040), Makpac	
QADPSKG3 (191U48-0)	Dual Port Multi Rapid Charger (DC40RB), 4X40Vmax - 5.0Ah Batteries (BL4050F), Makpac	

MAKPAC Power Source Kit



MKP1RF182 (197974-5)	Rapid Charger (DC18RC), 2X18V - 3.0Ah Batteries (BL1830B), Makpac	
MKP1RM182 (191L71-1)	Rapid Charger (DC18RC), 2X18V - 4.0Ah Batteries (BL1840B), Makpac	
MKP1RT182 (197803-2)	Rapid Charger (DC18RC), 2X18V - 5.0Ah Batteries (BL1850B), Makpac	
MKP1RG182 (198119-8)	Rapid Charger (DC18RC), 2X18V - 6.0Ah Batteries (BL1860B), Makpac	
MKP3PT182 (198182-1)	Dual Port Rapid Charger (DC18RD), 2X18V - 5.0Ah Batteries (BL1850B), Makpac	
MKP3PG182 (198081-7)	Dual Port Rapid Charger (DC18RD), 2X18V - 6.0Ah Batteries (BL1860B), Makpac	
MKP3PT184 (197627-6)	Dual Port Rapid Charger (DC18RD), 4X18V - 5.0Ah Batteries (BL1850B), Makpac	
MKP3PG184 (198095-6)	Dual Port Rapid Charger (DC18RD), 4X18V - 6.0Ah Batteries (BL1860B), Makpac	

MAKPAC Power Source Kit



MKP1SY122 (197654-3)	Fast Charger (DC10SB), 2X12Vmax - 1.5Ah Batteries (BL1016), Makpac	
MKP1SA122 (197664-0) (191K13-9)	Fast Charger (DC10SB), 2X12Vmax - 2.0Ah Batteries (BL1021B), Makpac	
MKP1SM122 (197640-4) (191K12-1)	Fast Charger (DC10SB), 2X12Vmax - 4.0Ah Batteries (BL1041B), Makpac	

XGT

40V Li-ion max

High Power

Durability

Digital Communication



XGT
40V Li-ion max

XGT X2
80V max



Rotary Hammer



Demolition Hammer



Power Cutter



Grass Trimmer



Vacuum Cleaner

Battery

BL4020
2.0Ah

BL4025 /
BL4025F
2.5Ah

BL4040 /
BL4040F
4.0Ah





Impact Driver

Driver Drill

Hammer Driver Drill

Rotary Hammer

Demolition Hammer

Combination Hammer

Brad Nailer

Air Compressor

Angle Drill

Mixer

Concrete Vibrator

Impact Wrench

Rear Handle Saw

Polisher

180+ TOOLS



Backpack Vacuum Cleaner



Recipro Saw



Circular Saw



Angle Grinder

Plunge Cut Saw

Slide Compound Miter Saw



Vacuum Cleaner



Jig Saw



Planer



Metal Cutter



Cleaner



Portable Band Saw



Trimmer

Charger

BL4050F 5.0Ah

BL4080F 8.0Ah

DC40RA

DC40RB

DC40WA

DC40RC

ADP10



Adapter for LXT Battery

18V LITHIUM-ION



LXT



18V Lithium-ion

Portable Cut-off

Power Cutter

Angle Grinder

Circular Saw

Backpack Vacuum Cleaner

Upright Cleaner

Fan

Job Site Speaker

Blower Vacuum

Robotic Cleaner

Trimmer

Drywall Saw

Belt Sander

Cut-Out Tool

Plate Joiner

Cyclone Cleaner

Rear Handle Saw

Plunge Cut Saw

Combination Hammer

Angle Drill

Shear Wrench

Brad Nailer

Inflator

Job Site Radio

Blower

Blower Vacuum

Vacuum Cleaner

Portable Vacuum Cleaner

Planer

Cut-Out Tool

Cleaner

Cyclone Cleaner

Recipro Saw

Rotary Hammer

Slide Compound Miter Saw

Pin Nailer

Finish Nailer

Hole Puncher

Grease Gun

LED Worklight

Job Site Radio

Blower

Blower Vacuum

Vacuum Cleaner

Portable Vacuum Cleaner

Planer

Cut-Out Tool

Cleaner

Cyclone Cleaner

Wall Scanner

Stapler

Concrete Vibrator

Hole Puncher

Radio with Lantern

Coffee Maker

Job Site Radio

Garden Sprayer

Dust Blower

Pruning Saw

String Trimmer

Multi Function Power Head

Cleaner

Cyclone Cleaner

Wall Scanner

Stapler

Concrete Vibrator

Hole Puncher

Radio with Lantern

Coffee Maker

Job Site Radio

Garden Sprayer

Dust Blower

Pruning Saw

String Trimmer

Multi Function Power Head

Cleaner

Cyclone Cleaner

Caulking Gun

Rivet Gun

LED Flashlight

Job Site Radio

Blower

Blower Vacuum

Vacuum Cleaner

Portable Vacuum Cleaner

Planer

Cut-Out Tool

Cleaner

Cyclone Cleaner

Wheelbarrow

Rebar Tying Tool

Area Worklight

Job Site Radio

Blower

Blower Vacuum

Vacuum Cleaner

Portable Vacuum Cleaner

Planer

Cut-Out Tool

Cleaner

Cyclone Cleaner

Heat Gun

Worklight

Flashlight

Job Site Radio

Blower

Blower Vacuum

Vacuum Cleaner

Portable Vacuum Cleaner

Planer

Cut-Out Tool

Cleaner

Cyclone Cleaner

Vacuum Pump

Worklight

Flashlight

Job Site Radio

Blower

Blower Vacuum

Vacuum Cleaner

Portable Vacuum Cleaner

Planer

Cut-Out Tool

Cleaner

Cyclone Cleaner

Heated Vest

Heated Jacket

Heated Jacket

Hedge Trimmer

String Trimmer

Grass Trimmer

Cleaner

Cyclone Cleaner

Fan Jacket

Fan Vest

Hedge Trimmer

String Trimmer

Grass Trimmer

Cleaner

Cyclone Cleaner

Heated Base Layer Shirt

Heated Blanket

Hedge Trimmer

String Trimmer

Grass Trimmer

Cleaner

Cyclone Cleaner

Lawn Mower

Heated Blanket

Hedge Trimmer

String Trimmer

Grass Trimmer

Cleaner

Cyclone Cleaner

Cooler & Warmer Box

Garden Sprayer

Pruning Saw

String Trimmer

Grass Trimmer

Cleaner

Cyclone Cleaner

Grass Shear

Dust Blower

Chain Saw

String Trimmer

Grass Trimmer

Cleaner

Cyclone Cleaner

Blower

Dust Blower

Chain Saw

String Trimmer

Grass Trimmer

Cleaner

Cyclone Cleaner

Cooler & Warmer Box

Garden Sprayer

Pruning Saw

String Trimmer

Grass Trimmer

Cleaner

Cyclone Cleaner

Blower

Dust Blower

Chain Saw

String Trimmer

Grass Trimmer

Cleaner

Cyclone Cleaner



Chain Saw

Pole Saw

Grass Trimmer

Pruning Shears

Lawn Mower

Earth Auger

Vacuum Pump

High Pressure Washer

Wheelbarrow

Portable Power Pack

Impact Wrench

Blower

Hedge Trimmer

Kettle

Vacuum Cleaner

Multi Function Power Head

Auto Feed Screwdriver

Mixer

Screwdriver

4 Mode Impact Driver

Angle Drill

Angle Impact Wrench

Oil-Pulse Driver

Driver Drill

Impact Driver

Angle Impact Driver

Ratchet Wrench

Hammer Driver Drill

Rotary Hammer

Power Scraper

Combination Hammer

Multi Tool

Steel Rod Cutter

Compact Cut Off

Metal Cutter

Recipro Saw

Die Grinder

Nibbler

Threaded Rod Cutter

Cutter

Circular Saw

Sander Polisher

Finishing Sander

Random Orbit Polisher

Portable Band Saw

Drywall Sander

Random Orbit Sander

Angle Grinder

Slide Compound Miter Saw

Compound Miter Saw

Jig Saw

18V x2

420+ TOOLS

6.0Ah 5.0Ah 4.0Ah 3.0Ah 2.0Ah 1.5Ah

Expand Your Lithium Line Up

A wide variety of Lithium-ion Garden Tools

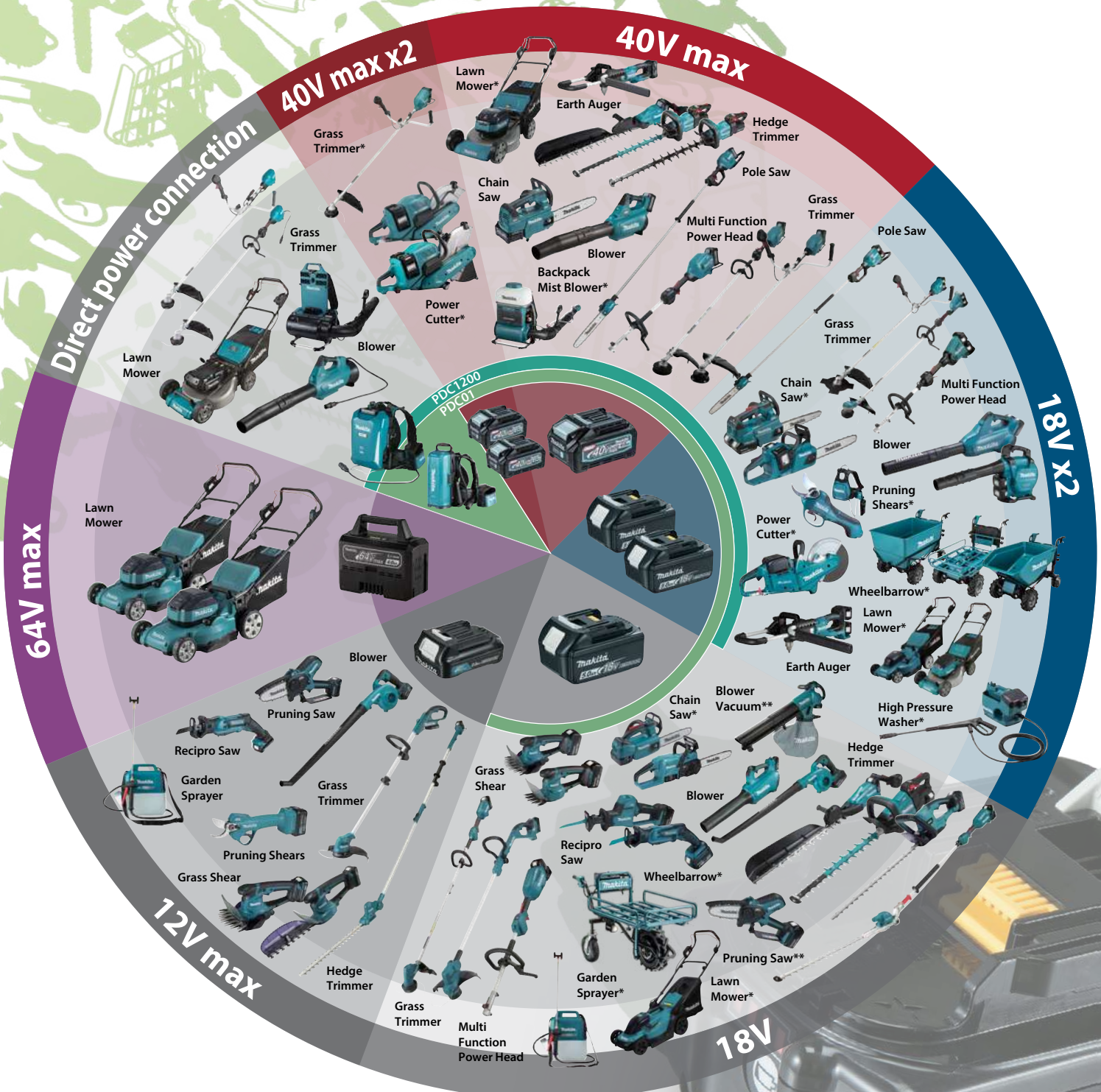

* These models are not compatible with Portable Power Pack (PDC1200, PDC01)

Only rear handle type chainsaws are compatible

** These models are not compatible with Portable Power Pack (PDC1200)



Makita Cordless Part Number Breakdown

DSE	Charger (DC10WA), 2X7.2V - 1.0Ah Batteries (BL7010)	
DW	Charger (DC10WA), 1X10.8V - 1.3Ah Battery (BL1013)	
DWE	Charger (DC10WA), 2X10.8V - 1.3Ah Batteries (BL1013)	
DWYE	Standard Charger (DC10WD), 2X12Vmax - 1.5Ah Batteries (BL1016)	
DSYE	Fast Charger (DC10SB), 2X12Vmax - 1.5Ah Batteries (BL1016)	
DSAE	Fast Charger (DC10SB), 2X12Vmax - 2.0Ah Batteries (BL1021B)	
DSAJ	Fast Charger (DC10SB), 2X12Vmax - 2.0Ah Batteries (BL1021B), Makpac	
DSME	Fast Charger (DC10SB), 2X12Vmax - 4.0Ah Batteries (BL1041B)	
SYE	Standard Charger (DC18SD), 2X18V - 1.5Ah Batteries (BL1815B)	
RYE	Rapid Charger (DC18RC), 2X18V - 1.5Ah Batteries (BL1815B)	
SF	Standard Charger (DC18SD), 1X18V - 3.0Ah Battery (BL1830B)	
RF	Rapid Charger (DC18RC), 1X18V - 3.0Ah Battery (BL1830B)	
RFE/ RF2	Rapid Charger (DC18RC), 2X18V - 3.0Ah Batteries (BL1830B)	
RFJ	Rapid Charger (DC18RC), 2X18V - 3.0Ah Batteries (BL1830B), Makpac	
RME	Rapid Charger (DC18RC), 2X18V - 4.0Ah Batteries (BL1840B)	
RTE/ RT2	Rapid Charger (DC18RC), 2X18V - 5.0Ah Batteries (BL1850B)	
RTJ	Rapid Charger (DC18RC), 2X18V - 5.0Ah Batteries (BL1850B), Makpac	
PT2	Dual Port Rapid Charger (DC18RD), 2X18V - 5.0Ah Batteries (BL1850B)	
PG2J	Dual Port Rapid Charger (DC18RD), 2X18V - 6.0Ah Batteries (BL1860B), Makpac	
G2	2X18V - 6.0Ah Batteries (BL1860B)	

Makita Coding System - Ending Alphabet

DDF484 R T E

Charger

S - Standard Charger
R - Rapid (Fast) Charger
P - Two Port Charger

Come with Battery

H - 1.3Ah **M** - 4.0Ah
Y - 1.5Ah **T** - 5.0Ah
A - 2.0Ah **G** - 6.0Ah
D - 2.5Ah **L** - 8.0Ah
F - 3.0Ah

Comes with
2 batteries

Other:
B - Double Insulation
C - Electronic Control
F - LED Light
K - Carrying Case
2 - 18V x 2 Tools

Z

Tool come with
carton box only

For more information, please contact Makita authorised distributor's technical team.

ACCESSORIES

Drilling (Wood/Metal)



Metal, mild steel



Stainless steel



Aluminum



Non-ferrous metal



Wood



Wood with nails



MDF



Plywood



Tile



Soft Tile



Brick



Soft brick



Marble



Concrete



Granite



Limestone



Plaster board



Plastic



Fiberglass



Sheet metal



Tungsten carbide tip for glass bit



Glass



Long life



Fast cut



n max. 10000



Chisel edge



M shape



Split point

Drilling (Wood / Metal)

HSS metal drill bit series

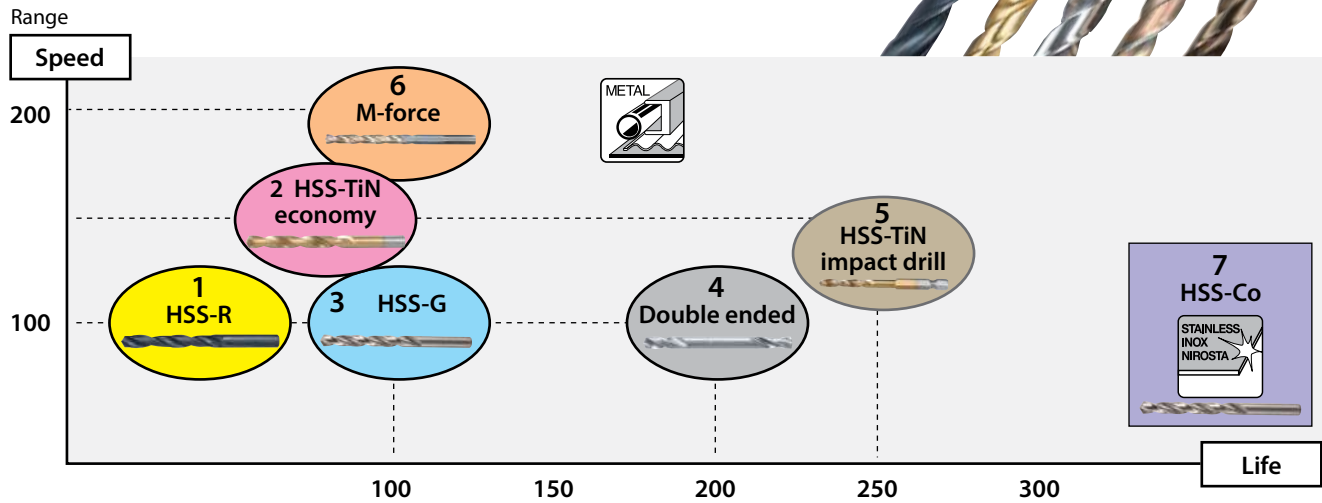
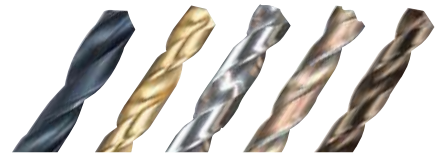

No.	1	2	3	4	5	6	7
Range	★	★★	★★★	★★★★	★★★★★	★★★★★	Specialized
Series							
Description	HSS-R 	HSS-TiN economy 	HSS-G 	Double ended 	HSS-TiN impact drill 	M-force 	HSS-Co5%
Made of							
* Process of manufacturing	Roll forged 	Ground 					
** Tip geometry	Chisel edge 118° 	Split point 135° 	Chisel edge 118° 	Split point 135° 	M-shape 		Split point 135°
Surface	Black oxide finish Rust resistant	TiN coating Long life	Bright finish 		TiN coating Long life	Amber finish Rust resistant	
Shank	Straight (Cylindrical) 				1/4"Hex 	Straight (Three flat) Better grip than Cylindrical shank	Straight (Cylindrical)

AA : Recommended A : Acceptable

No.	1	2	3	4	5	6	7
Material	Wood	A	A	A	A	A	A
	Plastic	AA	AA	AA	AA	AA	AA
	Non-ferrous metal***		AA	AA	AA	AA	A
	Sheet steel	A	AA	AA	AA	AA	AA
	Cast iron	AA	AA	AA	AA	AA	AA
	Alloy steel		AA	AA	AA	AA	AA
	Stainless steel		A	A	A	A	A































* Roll forged: Made by die-casted rolling machine. It is economical price.
Ground: Drill bits ground from the block with excellent surface quality.

** 135°split point: Ensure no walking and start fast, on contact.
M-shape: Designed to focus on drilling smoothly and speedily.

*** Non-ferrous metal (Such as Copper, Nickel and Zinc)

Drilling (Wood / Metal)

HSS metal drill bit line up

Series	Shank	Single pkg.	Set	Assortment					
		1pc. / 2pcs.	5pcs. / 10pcs.						
HSS-R	Straight (Cylindrical)	 1pc. / 2pcs.	 5pcs. / 10pcs. set	 13pcs. set	 19pcs. set	 25pcs. set			
HSS-TiN	Straight (Cylindrical)	 1pc. / 2pcs.	 5pcs. / 10pcs. set	 6pcs. set	 10pcs. set	 13pcs. set	 19pcs. set	 25pcs. set	 19pcs. set
HSS-G	Straight (Cylindrical)	 1pc.	 5pcs. / 10pcs. set	 6pcs. set	 19pcs. set	 25pcs. set	 13pcs. set	 19pcs. set	 25pcs. set
HSS-TiN	1/4" Hex (E-form)	 1pc.				 5pcs. set			
M-force	Straight (Three flat)	 1pc.			 19pcs. set	 25pcs. set			
HSS-Co	Straight (Cylindrical)	 1pc.	 5pcs. set	 6pcs. set	 19pcs. set	 25pcs. set			



Drilling (Wood / Metal)

HSS-R metal drill bit



Diameter (mm)	Length (mm)	Working Length (mm)	Sales Pkg Qty	Part No.
6.8	109	69	1	D-46953
8.8	125	81	1	D-46969
10.3	133	87	1	D-46975
10.8	142	94	1	D-46981

HSS-TiN metal drill bit economy



Diameter (mm)	Length (mm)	Working Length (mm)	1pc.	2pcs.	5pcs.	10pcs
			Part No.	Part No.	Part No.	Part No.
1	34	12	-	D-64004	-	D-64250
1.5	40	18	-	D-64010	-	D-64266
2	49	24	-	D-64026	-	D-64272
2.5	57	30	-	D-64032	-	D-64288
3	61	33	-	D-64048	-	D-64294
3.5	70	39	-	D-64054	-	D-64303
4	75	43	-	D-64060	-	D-64319
4.5	80	47	D-64076	-	-	D-64325
5	86	52	D-64082	-	-	D-64331
5.5	93	57	D-64098	-	-	D-64347
6	93	57	D-64107	-	-	D-64353
6.5	101	63	D-64113	-	-	D-64369
7	109	69	D-64129	-	-	D-64375
7.5	109	69	D-64135	-	-	D-64381
8	117	75	D-64141	-	-	D-64397
8.5	117	75	D-64157	-	D-64406	-
9	125	81	D-64163	-	D-64412	-
9.5	125	81	D-64179	-	D-64428	-
10	133	87	D-64185	-	D-64434	-
10.5	133	87	D-64191	-	D-64440	-
11	142	94	D-64200	-	D-64456	-
11.5	142	94	D-64216	-	D-64462	-
12	151	101	D-64222	-	D-64478	-
12.5	151	101	D-64238	-	D-64484	-
13	151	101	D-64244	-	D-64490	-
14	160	108	D-65741	-	-	-
15	169	114	D-65757	-	-	-
16	178	120	D-65763	-	-	-
17	184	125	D-65779	-	-	-
18	191	130	D-65785	-	-	-
19	198	135	D-65791	-	-	-
20	205	140	D-65800	-	-	-

HSS-TiN 5pcs., 10pcs. metal drill bit economy



Diameter	Length	Working Length	Sales Pkg Qty	Part No.
1/16"	1-7/8"	7/8"	10	D-64799
1/8"	2-3/4"	1-5/8"	10	D-64836
9/64"	2-7/8"	1-3/4"	10	D-64842
5/32"	3-1/8"	2"	10	D-64858
3/16"	3-1/2"	2-5/16"	10	D-64870
1/4"	4"	2-3/4"	10	D-64901
5/16"	4-1/2"	3-3/16"	10	D-64917
3/8"	5"	3-5/8"	5	D-64923
7/16"	5-1/2"	4-1/16"	5	D-64939
1/2"	6"	4-1/2"	5	D-64945

HSS-TiN metal drill bit economy set



Diameter (mm)	Sales Pkg Qty	Part No.
1.5 to 10	19	B-67795
1 to 10	19	D-72229
1 to 13	25	D-72235

HSS metal drill bit set



Diameter (mm)	Sales Pkg Qty	Part No.
4, 5, 6, 8, 10	5	D-30514

Drilling (Wood / Metal)

HSS-TiN metal drill bit with 1/4" Hex shank



Type NZ

Diameter (mm)	Length (mm)	Working Length (mm)	Sales Pkg Qty	Part No.
2.5	78	30	1	D-46539
3.0	91	33	1	D-31114
3.3	95	36	1	D-31136
4.0	105	43	1	D-31142
4.1	95	43	1	D-16483
4.2	105	43	1	D-31164
5	116	52	1	D-31170
5.2	102	52	1	D-46545
6	123	57	1	D-31186
6.5	131	63	1	D-31192
8	117	75	1	D-31201
10	133	87	1	D-31217
12	151	101	1	D-31223
13	151	101	1	D-31239

HSS-G metal drill bit



Diameter (mm)	Length (mm)	Working Length (mm)	1pc.	5pcs.	10pcs.
			Part No.	Part No.	Part No.
1.5	40	18	D-09656	-	D-06236
1.75	46	22	-	-	D-06242
2	49	24	D-09662	-	D-64272
2.25	53	27	-	-	D-06264
2.5	57	30	D-09678	-	D-06270
2.75	61	33	-	-	D-06286
2.9	61	33	D-46816	-	D-46648
3	61	33	D-09684	-	D-64294
3.2	65	36	D-46589	-	D-34942
3.25	65	36	-	-	D-06301
3.3	65	36	D-46595	-	-
3.5	70	39	D-09690	-	D-64303
3.75	70	39	-	-	D-06323
4	75	43	D-09709	-	-
4.2	75	43	D-46604	-	D-17762
4.25	75	43	-	-	D-06345
4.5	80	47	D-09715	-	D-06351
4.75	80	47	-	-	D-06367
5	86	52	D-09721	-	D-64331
5.2	86	52	D-46610	-	D-34986
5.25	86	52	-	-	D-06389
5.3	86	52	D-46822	-	-
5.5	93	57	D-09737	-	D-64347
6	93	57	D-09743	-	D-64353
6.25	101	63	-	-	D-06426
6.5	101	63	D-09759	-	D-64369
6.75	109	69	-	-	D-06448
6.8	109	69	D-46838	-	-
7	109	69	D-09765	-	D-64375
7.25	109	69	-	-	D-06460
7.5	109	69	D-09771	-	D-06476
7.75	117	75	-	-	D-06482
8	117	75	D-09787	-	D-64397
8.5	117	75	-	D-64406	-
8.75	125	81	-	D-06529	-
8.8	125	81	D-46844	-	-
9	125	81	D-09802	D-64412	-
9.5	125	81	D-09818	D-06557	-
10	133	87	D-09824	D-64434	-
10.3	133	87	D-46850	-	-
10.5	133	87	D-09830	D-64440	-
10.8	142	94	D-46866	-	-
11	142	94	D-09846	D-64456	-
11.5	142	94	D-09852	D-64462	-
12	151	101	D-09868	D-64478	-
12.5	151	101	D-09874	D-06638	-
13	151	101	D-09880	D-64490	-

HSS-TiN impact drill bit for SDS-PLUS Hammers



Type NZ

Diameter (mm)	Length (mm)	Working Length (mm)	Sales Pkg Qty	Part No.
3	90	33	1	B-57401
3.5	100	39	1	B-57417
4	105	43	1	B-57423
4.5	110	47	1	B-57439
5	116	52	1	B-57445
5.5	123	57	1	B-57451
6	12	57	1	B-57467
6.5	131	63	1	B-57473

Drilling (Wood / Metal)

HSS-G 5pcs,10pcs. metal drill bit set



Size: inch

Diameter	Length	Working Length	Sales Pkg Qty	Part No.
1/8"	2-3/4"	1-5/8"	10	D-21989
5/32"	3-1/8"	2"	10	D-22006
3/16"	3-1/2"	2-5/16"	10	D-22028
1/4"	4"	2-3/4"	10	D-22062
5/16"	4-1/2"	3-3/16"	10	D-22109
3/8"	5"	3-5/8"	10	D-37219
1/2"	6"	4-1/2"	5	D-22224

Rivet drill bit 1/4" Hex. shank



Type MZ

Diameter (mm)	Length (mm)	Working Length (mm)	Sales Pkg Qty	Part No.
3.3	50	25	5	B-38869 / B-56437(new)

HSS-TiN impact drill bit with 1/4" Hex shank



Type NZ

Diameter (mm)	Length (mm)	Working Length (mm)	Sales Pkg Qty	Part No.
3	64	26	1	B-51085
3.5	70	29	1	B-51116
4	71	30	1	B-51122
6	80	37	1	B-51172
10	102	50	1	B-51247



Drilling (Wood / Metal)

M-Force HSS metal drill bit



Diameter (mm)	Length (mm)	Working Length (mm)	Sales Pkg Qty	Part No.
2	49	24	1	D-29614
2.5	57	30	1	D-29620
3.0	61	33	1	D-29636
3.2	65	36	1	D-37633
3.3	65	36	1	D-46626
3.5	70	39	1	D-29642
4.0	75	43	1	D-29658
4.2	75	43	1	D-37649
4.5	80	47	1	D-29664
5	86	52	1	D-29670
5.2	86	52	1	D-37655
5.5	93	57	1	D-29686
6	93	57	1	D-29692
6.5	101	63	1	D-29701
7	109	69	1	D-29717
7.5	109	69	1	D-29723
8	117	75	1	D-29739
8.5	117	75	1	D-29745
9	125	81	1	D-29751
9.5	125	81	1	D-29767
10	133	87	1	D-29773
10.5	133	87	1	D-29789
11	142	94	1	D-29795
11.5	142	94	1	D-29804
12	151	101	1	D-29810
12.5	151	101	1	D-29826
13	151	101	1	D-29832



HSS-Co metal drill bit (Cobalt 5%)



Diameter (mm)	Length (mm)	Working Length (mm)	1pc.	5pcs.
			Part No.	Part No.
1.5	40	18	D-17289	-
1.75	46	22	-	-
2	49	24	D-17295	D-16623
2.5	57	30	D-17304	D-16639
3.0	61	33	D-17310	D-16645
3.2	65	36	D-17326	-
3.3	65	36	D-46660	-
3.5	70	39	D-17332	D-16667
4.0	75	43	D-17348	-
4.2	75	43	D-46676	-
4.5	80	47	D-17354	D-16689
5	86	52	D-17360	D-16695
5.2	86	52	D-46682	D-34992
5.5	93	57	D-17376	D-16704
6	93	57	D-17382	D-16710
6.5	101	63	D-17398	D-16726
7	109	69	D-17407	D-16732
7.5	109	69	D-17413	-
8	117	75	D-17429	D-16754
8.5	117	75	D-17435	-
9	125	81	D-17441	D-16776
9.5	125	81	D-17457	D-16782
10	133	87	D-17463	D-16798
10.5	133	87	D-17479	D-16807
11	142	94	D-17485	D-16813
11.5	142	94	D-17491	D-16829
12	151	101	D-17500	-
12.5	151	101	D-17516	D-16841
13	151	101	D-17522	D-16857

Drilling (Wood / Metal)

M-Force HSS metal drill bit set



Diameter (mm)	Sales Pkg Qty	Part No.
4, 5, 6, 8, 10	5	D-30508
1 to 10	19	D-67583
1 to 13	25	D-67599

HSS-Co metal drill bit assortment



Diameter (mm)	Sales Pkg Qty	Part No.
2, 3, 4, 5, 6, 8mm (1pc.each)	6pc. Assortment	D-57168

Double ended drill bit



Diameter (mm)	Length (mm)	Working Length (mm)	Sales Pkg Qty	Part No.
2	38	7.5	10	B-26652
3.0	46	10.6	10	B-26668
3.1	49	11	10	B-26674
3.2	49	11	10	B-26680
3.3	49	11	10	B-26696
3.5	52	13	10	B-26705
3.8	55	14	10	B-26711
4.0	55	14	10	B-26727
4.1	55	14	10	B-26733
4.2	55	14	10	B-26749
4.3	55	14	10	B-26755
4.5	58	16	10	B-26761
4.8	62	17	10	B-26777
4.9	62	17	10	B-26783
5	62	17	10	B-26799
5.1	62	17	10	B-26808
5.2	62	17	10	B-26814
5.5	66	19	10	B-26820
6	66	19	10	B-26836
6.5	70	21	10	B-33788
8	79	25	10	B-26842
10	89	25	10	B-26858



Drilling (Wood / Metal)

Step drill bit

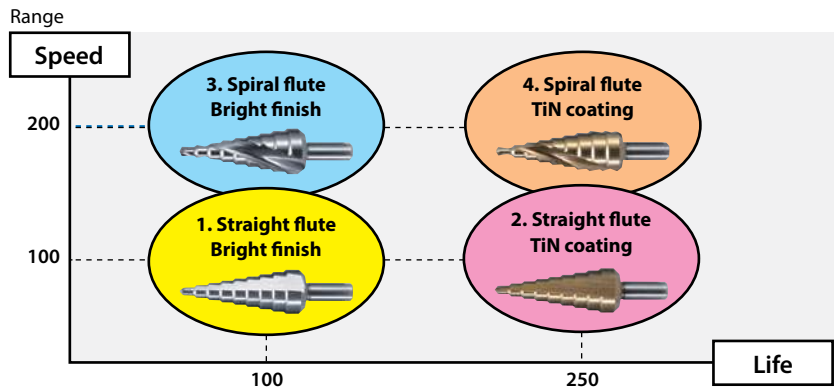

Material chart

AA: Recommended A: Acceptable

Description	Flute	Surface	Shank	Material				
				Plastic	Non-ferrous metal*	Sheet steel	Alloy steel	Cast iron
1		Bright finish	Straight (Three flat)	AA	AA	AA	A	A
2		Titanium coating		AA	AA	AA	A	A
3		Bright finish	1/4"Hex (E form)	AA	AA	AA	A	A
4		Titanium coating		AA	AA	AA	A	A

Non-ferrous metal (Such as Copper, Nickel and Zinc)

Countersink bit



Material chart

AA: Recommended A: Acceptable

Description	Made of	Type	Shank	Material					
				Wood	Plastic	Non-ferrous metal*	Cast iron	Alloy steel	Stainless steel
7cutting edge	Alloy steel		1/4"Hex (E form)	AA	AA	AA	AA		
5cutting edge			Straight shank (Three flat)	AA	AA	AA	AA	AA	
3cutting edge	High speed steel		1/4"Hex (C-form)	AA	AA	AA	AA	AA	
3cutting edge			Straight shank (Three flat)	AA	AA	AA	AA	AA	
Slanting hole	High speed steel		Straight shank (Three flat)		AA	AA	AA	AA	A

*Non-ferrous metal (Such as Copper, Nickel and Zinc)

Drilling (Wood / Metal)

Cone drill bit



Shank type	Diameter (mm)	Length (mm)	Sales Pkg Qty	Part No.
Straight	3 to 14	58	1	D-40048
	4 to 20	71	1	D-40054
	16 to 30.5	76	1	D-40060
	24 to 40	58	1	D-40076



Step drill bit straight flute



Shank type	Diameter (mm)	Length (mm)	Sales Pkg Qty	Part No.
1/4inch Hex MZ	4 to 12	65	1	D-40082
	4 to 20	75	1	D-40098
Straight	4 to 32	102	1	D-40107

Step drill bit straight flute titanium coating



Shank type	Diameter (mm)	Length (mm)	Sales Pkg Qty	Part No.
1/4inch Hex MZ	4 to 12	65	1	D-40113
	4 to 20	75	1	D-40129
Straight	4 to 32	102	1	D-40135

Step drill bit spiral flute



Shank type	Diameter (mm)	Length (mm)	Sales Pkg Qty	Part No.
1/4inch Hex MZ	4 to 12	65	1	D-40141
	4 to 20	75	1	D-40157
Straight	4 to 32	102	1	D-40163

Step drill bit spiral flute titanium coating



Shank type	Diameter (mm)	Length (mm)	Sales Pkg Qty	Part No.
1/4inch Hex MZ	4 to 12	65	1	D-40179
	4 to 20	75	1	D-40185
Straight	4 to 32	102	1	D-40191



Drilling (Wood / Metal)

Countersink bit with three 90° cutting edges



Shank type	Diameter (mm)	Length (mm)	Sales Pkg Qty	Part No.
1/4inch Hex C-form	6.3	31	1	D-37312
	8.3	31	1	D-37328
	10.4	34	1	D-37334
	12.4	35	1	D-37340
	16.5	40	1	D-37356
	20.5	41	1	D-37362
Straight	6.3	45	1	D-37437
	8.3	50	1	D-37443
	10.4	50	1	D-37459
	12.4	56	1	D-37465
	16.5	60	1	D-37471
	20.5	63	1	D-37487
25	67	1	D-37493	

Countersink bit with five 90° cutting edges



Shank type	Diameter (mm)	Length (mm)	Sales Pkg Qty	Part No.
Straight	6	48	1	D-37378
	8	48	1	D-37384
	10	40	1	D-37390
	12	40	1	D-37409
	16	43	1	D-37415
	20	45	1	D-37421

Countersink bit with seven 90° cutting edges



Shank type	Diameter (mm)	Length (mm)	Sales Pkg Qty	Part No.
Straight	13	50	1	D-37306

Slanting hole countersink bit



Shank type	Diameter (mm)	Length (mm)	Sales Pkg Qty	Part No.
Straight	2 to 5	45	1	D-37502
	5 to 10	48	1	D-37518
	10 to 15	65	1	D-37524
	15 to 20	85	1	D-37530



Drilling (Wood / Metal)

Broach Cutter For Magnetic Drilling Machine



Short = 25mm Depth	
Diameter	Part No.
12mm Short	(MM)12S
13mm Short	(MM)13S
14mm Short	(MM)14S
15mm Short	(MM)15S
16mm Short	(MM)16S
17mm Short	(MM)17S
18mm Short	(MM)18S
19mm Short	(MM)19S
20mm Short	(MM)20S
21mm Short	(MM)21S
22mm Short	(MM)22S
23mm Short	(MM)23S
24mm Short	(MM)24S
25mm Short	(MM)25S
26mm Short	(MM)26S
27mm Short	(MM)27S
28mm Short	(MM)28S
29mm Short	(MM)29S
30mm Short	(MM)30S
31mm Short	(MM)31S
32mm Short	(MM)32S
33mm Short	(MM)33S
34mm Short	(MM)34S
35mm Short	(MM)35S
36mm Short	(MM)36S
37mm Short	(MM)37S
38mm Short	(MM)38S
39mm Short	(MM)39S
40mm Short	(MM)40S
41mm Short	(MM)41S
42mm Short	(MM)42S
43mm Short	(MM)43S
44mm Short	(MM)44S
45mm Short	(MM)45S
46mm Short	(MM)46S
47mm Short	(MM)47S
48mm Short	(MM)48S
49mm Short	(MM)49S
50mm Short	(MM)50S

Long = 50mm Depth	
Diameter	Part No.
12mm Long	(MM)12L
13mm Long	(MM)13L
14mm Long	(MM)14L
15mm Long	(MM)15L
16mm Long	(MM)16L
17mm Long	(MM)17L
18mm Long	(MM)18L
19mm Long	(MM)19L
20mm Long	(MM)20L
21mm Long	(MM)21L
22mm Long	(MM)22L
23mm Long	(MM)23L
24mm Long	(MM)24L
25mm Long	(MM)25L
26mm Long	(MM)26L
27mm Long	(MM)27L
28mm Long	(MM)28L
29mm Long	(MM)29L
30mm Long	(MM)30L
31mm Long	(MM)31L
32mm Long	(MM)32L
33mm Long	(MM)33L
34mm Long	(MM)34L
35mm Long	(MM)35L
36mm Long	(MM)36L
37mm Long	(MM)37L
38mm Long	(MM)38L
39mm Long	(MM)39L
40mm Long	(MM)40L
41mm Long	(MM)41L
42mm Long	(MM)42L
43mm Long	(MM)43L
44mm Long	(MM)44L
45mm Long	(MM)45L
46mm Long	(MM)46L
47mm Long	(MM)47L
48mm Long	(MM)48L
49mm Long	(MM)49L
50mm Long	(MM)50L

Broach Cutter Pilot Pin



Pilot pin	Part No.
25mm	(MM)PILOT S
50mm	(MM)PILOT L

Chuck Adapter

For use with	Part No.
A: Chuck Adaptor	MMCHU03
B: 1/2" Chuck Adaptor For HB500	MMCHU05
C: Arbor (Minibor)	20358



Drilling (Wood / Metal)















Wood drill bit series

AA : Recommended A : Acceptable

Category	Flat bit		Brad point drill bit			Single spur auger bit			Ship auger bit					
														
Description	Suitable for drilling holes with medium to large diameters in soft wood or soft plastic. It's simple made and reasonable price. It's popular especially in America.		Fast drilling bit with making-off blades and rake blades			This is the most popular drill in wood drill and suitable for drilling holes with small to medium diameter. Able to drill soft plastics other than general wood. Highly effective for drilling cleaner and more precise holes than flat bit.			Suitable for drilling of deep holes with medium to large diameters holes in soft and hard wood. Threaded screw point pull the bit into the work piece providing a fast, easy to use self feeding action. Highly effective for drilling cleaner and more precise holes than flat bit or wood drill bit.		Features of this item are fast drilling speed and good work amount per 1 charge.		Suitable for knotty nail embedded wood which unable to drill with single spur auger bit. Suitable for plumbing and electrical installation, etc.	
Information	Shank	Straight (Hex) 	1/4"Hex (E-form) 	Straight (Cylindrical) 	1/4"Hex (E-form) 	SDS-PLUS 	Straight (Hex) 	1/4"Hex (E-form) 	Straight (Hex) 	5/16" & 7/16"Hex 				
	Diameter	6 - 36mm		3 - 20mm	2 - 15mm	4 - 10mm	6 - 30mm	6-21mm	6 - 30mm	10-38mm				
	Point	Brad point 		Brad point 			Auger thread 			Auger thread 		Auger thread 		
Material	Wood 	AA		AA			AA			A				
	Wood with nail 									AA				
	Plywood 			A			A			A				
Processing	Thickness 													
	Blind hole 			A										
Action photo														



AA : Recommended A : Acceptable

Category		Formwork drill bit	Self feeding bit	Forstner drill bit	T.C.T. Hinge cutting bit	Adjustable circle cutter
Description		Rarely being clogged even drilling on plywood including adhesive because of chisel edge.Can be used on formboard or 2x4 timbers at once because of their long overall length (400 & 600mm)	Suitable for drilling large diameter holes for pipe and conduit in wood.Threaded screw point pull the bit into the work piece providing a fast, easy to use self feeding action. Suitable for plumbing and electrical installation, etc	Suitable for drilling of blind holes or penetrating holes of medium to large diameter with highly. Can drill cleaner and more precise holes than T.C.T. Hinge drill bit. Suitable for precise working like a making furniture.	Suitable for drilling of blind holes or penetrating holes of medium or large diameter.Suitable for drilling holes in fancy plywood because making-off blade and rake blade are made T.C.T. tip.	Adjustable drilling diameter and able to work on plaster board mainly. Suitable for plumbing and installation of the downlight.
Information	Shank	Straight (Cylindrical) 	7/16"Hex 	Straight (Cylindrical) 	Straight (Cylindrical) 	Straight (Three flat) 
	Diameter	8-30mm	25-117mm	10-50mm	15-35mm	30-200mm
	Point	Chisel edge 	Auger thread 	Brad point (Short) 	Brad point (Short) 	Chisel edge 
Material	Wood 	A	AA	AA	AA	A
	Wood with nail 	A				
	Plywood 	AA			A	A
Processing	Thickness 					
	Blind hole 			AA	AA	
Action photo						

Drilling (Wood / Metal)

Wood Flat Bit



Diameter (mm)	Length (mm)	Sales Pkg Qty	Part No.
8	150	1	D-07680
10	150	1	D-07696
12	150	1	D-07705
14	150	1	D-07711
15	150	1	D-07727
16	150	1	D-07733
18	150	1	D-07749
20	150	1	D-07755
22	150	1	D-07761
24	150	1	D-07777
25	150	1	D-07783
26	160	1	D-07799
28	160	1	D-07808
30	160	1	D-07814
35	160	1	D-07842

Wood brad point drill bit



Diameter (mm)	Length (mm)	Working Length (mm)	Sales Pkg Qty	Part No.
3	60	33	1	D-07026
4	75	43	1	D-07032
5	85	52	1	D-07048
6	95	57	1	D-07054
6	315	150	1	D-07157
7	110	69	1	D-07060
8	115	75	1	D-07076
8	315	150	1	D-07163
9	125	80	1	D-07082
10	135	87	1	D-07098
10	315	150	1	D-07179
12	155	96	1	D-07107
12	315	150	1	D-07185
13	151	96	1	D-53453
14	170	100	1	D-07113
14	315	150	1	D-07191
15	160	100	1	D-53469
16	40	150	1	D-07200
16	180	100	1	D-07129
18	200	120	1	D-07135
18	335	150	1	D-07216
20	250	130	1	D-07141
20	335	150	1	D-07222

Wood single spur auger bit with Hex shank



Diameter (mm)	Length (mm)	Working Length (mm)	Sales Pkg Qty	Part No .
6	200	130	1	D-07238
6	250	180	1	D-07331
8	200	130	1	D-07244
8	250	180	1	D-07347
8	450	380	1	D-07559
10	200	130	1	D-07250
10	250	180	1	D-07353
10	450	380	1	D-07565
12	200	130	1	D-07266
12	250	180	1	D-07369
13	250	180	1	D-53475
13	450	380	1	D-53497
14	200	130	1	D-07272
14	250	180	1	D-07375
15	250	180	1	D-53481
15	450	380	1	D-53506
16	60	380	1	D-07593
16	200	130	1	D-07288
16	250	180	1	D-07381
18	200	130	1	D-07294
18	250	180	1	D-07397
18	450	380	1	D-07602
20	200	130	1	D-07303
20	250	180	1	D-07406
20	400	330	1	D-07490
20	450	380	1	D-07618
22	200	130	1	D-07319
22	450	380	1	D-07624
24	200	130	1	D-07325
24	250	180	1	D-07428
24	450	380	1	D-07630
26	450	380	1	D-07646
28	450	380	1	D-07652



Drilling (Wood / Metal)

Wood brad point drill bit with 1/4" Hex shank



Type NZ

Diameter (mm)	Length (mm)	Working Length (mm)	Sales Pkg Qty	Part No.
3	78	33	1	D-31245
4	92	50	1	D-31251
5	103	57	1	D-31267
6	110	65	1	D-31273
8	117	75	1	D-31289
10	133	87	1	D-31295
12	151	96	1	D-31304
15	162	100	1	D-31310

Wood single spur auger bit with 1/4" Hex shank



Type NZ

Diameter (mm)	Length (mm)	Working Length (mm)	Sales Pkg Qty	Part No.
6	200	130	1	D-31326
8	200	130	1	D-31332
10	200	130	1	D-31348
12	200	130	1	D-31354
14	200	130	1	D-31360
16	200	130	1	D-31376
18	200	130	1	D-31382
20	200	130	1	D-31398
21	200	130	1	D-31407

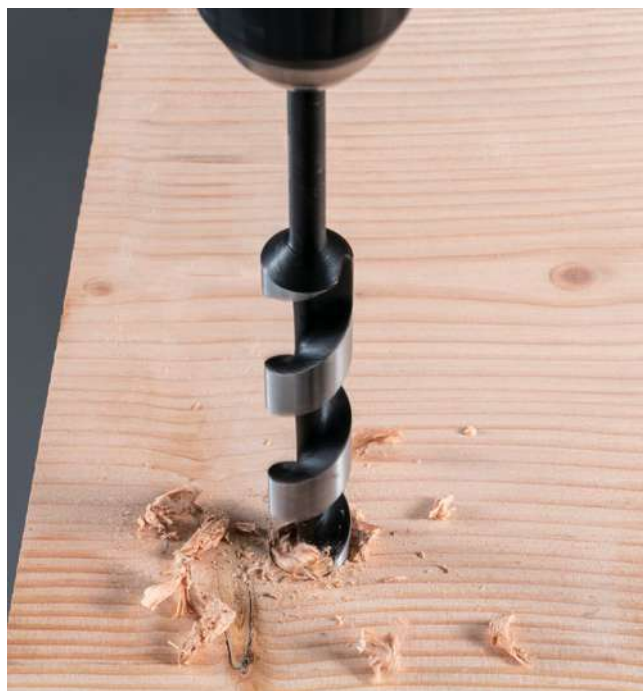

Wood ship auger bit with 7/16" Hex shank

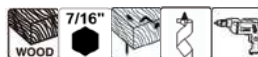

Diameter (mm)	Length (mm)	Working Length (mm)	Sales Pkg Qty	Part No.
10	165	100	1	*D-36055
12	165	100	1	*D-36061
14	165	100	1	D-36077
16	60	100	1	D-36083
18	165	100	1	D-36099
20	165	100	1	D-36108
22	165	100	1	D-36114
24	165	100	1	D-36120
26	165	100	1	D-36136
28	165	100	1	D-36142
30	165	100	1	D-36158
32	165	100	1	D-36164
35	165	100	1	D-36170
38	165	100	1	D-36186

Wood Formwork drill bit



Diameter (mm)	Length (mm)	Working Length (mm)	Sales Pkg Qty	Part No.
8	400	75	1	D-70219
8	600	75	1	D-70334
10	400	87	1	D-70225
10	600	87	1	D-70340
12	400	101	1	D-70231
12	600	101	1	D-70356
14	400	108	1	D-70247
14	600	108	1	D-70362
16	400	100	1	D-70253
16	600	100	1	D-70378
18	400	100	1	D-70269
18	600	100	1	D-70384
20	400	100	1	D-70275
20	600	100	1	D-70390
22	400	100	1	D-70281
22	600	100	1	D-70409
24	400	100	1	D-70297
24	600	100	1	D-70415
26	400	100	1	D-70306
26	600	100	1	D-70421
28	400	100	1	D-70312
28	600	100	1	D-70437
30	400	100	1	D-70328
30	600	100	1	D-70443

Drilling (Wood / Metal)

Wood brad point drill bit for SDS-PLUS Hammers



Diameter (mm)	Length (mm)	Working Length (mm)	Sales Pkg Qty	Part No.
4	105	43	1	B-57489
5	116	52	1	B-57495
6	123	57	1	B-57504
8	147	75	1	B-57510
10	163	87	1	B-57526

Wood TCT Hinge cutting bit



Diameter (mm)	Length (mm)	Sales Pkg Qty	Part No.
15	77	1	D-71093
19	77	1	D-71102
20	77	1	D-71118
25	77	1	D-71124
26	77	1	D-71130
30	77	1	D-71146
32	77	1	D-71152
35	77	1	D-71168

Earth auger drill bit with 3/4" SQ shank



Diameter (mm)	Length (mm)	Working Length (mm)	Sales Pkg Qty	Part No.
20	600	530	1	*B-54302
25			1	*B-54318
30			1	*B-54324
35			1	*B-54330
40			1	*B-57576

Earth auger drill bit for Driver Drill



Diameter (mm)	Length (mm)	Working Length (mm)	Sales Pkg Qty	Part No.
30	600	200	1	D-75415
45			1	D-75421
70			1	D-75437

Drill bit 5pcs set



Diameter (mm)	Shank Dia (mm)	Sales Pkg Qty	Part No.
Metal 5, 6, 8 Wood 6, 8	5, 6, 8	5	D-30106

Drill bit set for SDS-PLUS Hammers

Replace commonly used hammer drill in ordinary families with this compact and handy rotary hammer



Diameter (mm)	Sales Pkg Qty	Part No.
Metal 3,4 Wood 4,5,6	5	B-57532

Drill bit 5pcs set with 1/4" Hex shank



Diameter (mm)	Sales Pkg Qty	Part No.
Masonry 6 Metal 5, 6 Wood 5, 6	5	D-31522
Metal 5, 6, 8 Wood 5, 6	5	D-31516

Drilling (Wood / Metal)

Holesaw

BiM holesaw

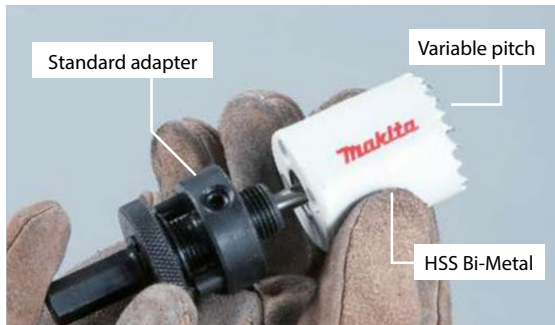

TCT holesaw

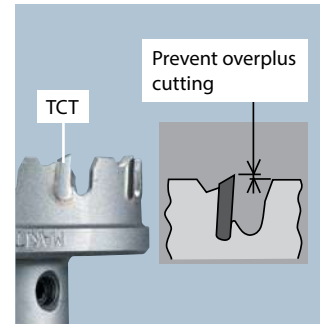

Diamond wet holesaw

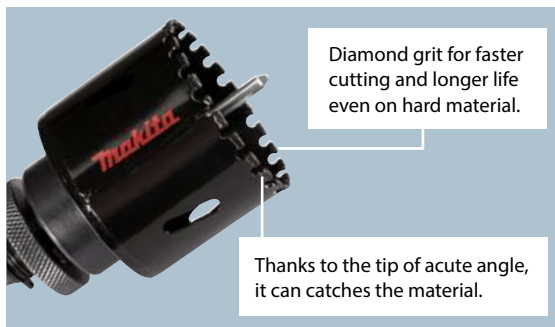



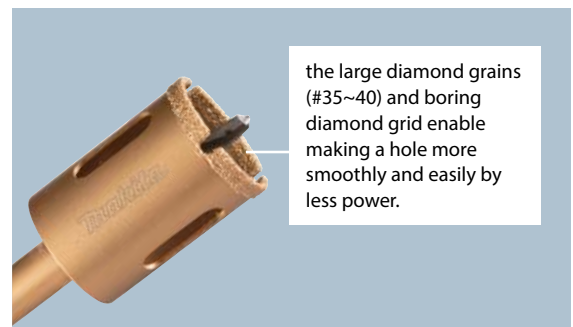



Vacuum brazed diamond holesaw



Material Chart

AA : Recommended A : Acceptable

Application	Steel	Inox Stainless	Aluminum	Non ferrous Metal	Wood	MDF	PLASTER BOARD	PVC	FRP	SOFT TILE	Brick	Lime stone	Marble
	METAL	STAINLESS INOX INROSTA	ALU	Cu CS Ni Me Zn	WOOD			PVC	FIBREGLASS				
BiM 	AA		A	A	AA			AA					
BiM for sheet metal 	AA	AA	A	A									
Vacuum brazed diamond 										AA	AA	AA	AA
Diamond wet holesaw 										AA			AA
TCT 	AA	AA	A	A				AA	AA				
TC grit 										AA	AA		

Drilling (Wood / Metal)

BiM Hole saw

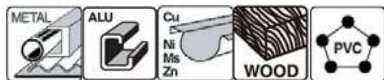

Size (mm)	Working Length (mm)	Part No.
14	38	D-35368
16	38	D-16994
17	38	D-35374
19	38	D-17005
20	38	D-17251
21	38	D-35380
22	38	D-17011
24	38	D-17027
25	38	D-17033
27	38	D-35396
29	38	D-17267
30	38	D-35405
32	38	D-17049
33	38	D-35411
35	38	D-17055
40	38	D-17273
41	38	D-35433
43	38	D-35449
44	38	D-17077
46	38	D-35455
48	38	D-35461
51	38	D-17083
52	38	D-35477
54	38	D-24876
57	38	D-17099
60	38	D-25688
64	38	D-30140
65	38	D-24882
67	38	D-35508
68	38	D-17108
70	38	D-25694
73	38	D-35514
76	38	D-17114
79	38	D-35520
80	38	D-33869
83	38	D-17120
86	38	D-35536
89	38	D-35542
92	38	D-17136
95	38	D-35558
98	38	D-35564
102	38	D-35570
105	38	D-17142
108	38	D-35586
111	38	D-35592
114	38	D-35601
121	38	D-35617
127	38	D-17158
152	38	D-17164

or Ezychange BiM Holesaw

Pilot drill



Adapter



Application	Fits Holesaw	Part No.
-------------	--------------	----------

Adapter with pilot drill

For 10mm drill	14 - 29mm	D-17170
For 13mm drill	32 - 152mm	D-17186
For SDS-PLUS Hammer	14 - 29mm	D-17603
For SDS-PLUS Hammer	32 - 76mm	D-17619

Pilot drill

Length 71mm	All	D-17192
-------------	-----	---------

BiM holesaw assortment

Most six common sizes for Plumber & Electrician.

A: 11mm (*7/16")
Adapter with pilot drill

B: 9.5mm (*3/8")
Adapter with pilot drill

C: Ejector spring



Suitable for	Included holesaws (1 each)	Part No.
For Plumber	19,22,29,38,44,57mm,adapter A, adapter B, ejector spring	D-47117
For Electrician	16,20,25,32,40,51mm,adapter A, adapter B, ejector spring	D-47123
For Electrician	20,25,32,40,51,65mm,adapter A, adapter B, ejector spring	D-47139

Drilling (Wood / Metal)

BiM holesaw for sheet metal



Size (mm)	Working Length (mm)	Part No.	Size (mm)	Working Length (mm)	Part No.
16	20	B-29670	51	20	B-29854
19	20	B-29692	60	20	B-29882
20	20	B-29701	64	20	B-29898
22	20	B-29723	65	20	B-35994
25	20	B-29739	68	20	B-36011
29	20	B-29751	70	20	B-36027
32	20	B-29773	76	20	B-36049
35	20	B-29795	83	20	B-36061
38	20	B-29804	89	20	B-36083
40	20	B-29810	102	20	B-36099
48	20	B-29848	127	20	B-36108
			152	20	B-36114

Adapter with HSS pilot drill



Pilot drill



Application	Fits Holesaw	Part No.
Adapter with pilot drill		
For 10mm drill	16 - 35mm	B-36120
For 13mm drill	38 - 152mm	B-36136

Pilot drill

Length 60mm	All	B-36142
-------------	-----	---------

TC grit holesaw



Size (mm)	Working Length (mm)	Part No.
33mm (1-5/16")	64	D-51188
43mm (1-11/16")	64	D-51194
53mm (2-3/32")	64	D-51203
63mm (2-1/2")	64	D-51219
67mm (2-5/8")	64	D-51225
73mm (2-7/8")	64	D-51231
83mm (3-1/4")	64	D-51247

Adapter with TCT pilot drill



TCT pilot drill



Application	Fits hole saws	Part No.
Adapter with Pilot Drill	All	D-51253
Pilot drill	All	D-51269

Drilling (Wood / Metal)

Vacuum brazed diamond holesaw



Size (mm)	Working Length (mm)	Part No.
16	40	B-45995
19	40	B-46006
25	40	B-46012
30	40	B-46028
32	40	B-46034
35	40	B-46040
38	40	B-46056
45	40	B-46062
50	40	B-46078
53	40	B-46084
57	40	B-46090
64	40	B-46109

Holesaw with shank and pilot drill



Size (mm)	Working Length (mm)	Part No.
16	40	B-45870
19	40	B-45886
25	40	B-45892
30	40	B-45901
32	40	B-45917

Size (mm)	Working Length (mm)	Part No.
35	40	B-45923
38	40	B-45939
45	40	B-45945
50	40	B-45951
53	40	B-45967
57	40	B-45973
64	40	B-45989

Shank with pilot drill



Shank



Pilot drill



Application	Type of pilot drill	Fits Holesaw	Part No.
-------------	---------------------	--------------	----------

Shank with pilot drill

For 13mm drill	TCT	All	B-46115
----------------	-----	-----	---------

Pilot drill

For 13mm drill	TCT	All	B-46121
----------------	-----	-----	---------



ACCESSORIES

▣ Drilling (Masonry)



Metal, mild steel



Aluminum



Wood



Tile



Concrete



Reinforced concrete



Brick



Stone



Asphalt



Plastic



Mine



2cutter



4cutter



Centering tip



Self sharpening



Dustless

Drilling (Masonry)

T.C.T drill bit with Straight shank/ Brick



Bit Dia (mm)	Length (mm)	Working Length (mm)	Sales Pkg Qty	Part No.
3.5	75	40	1	D-40733
4.5	85	55	1	D-40755
5	85	55	1	D-40761
5.5	150	100	1	D-40799
6	400	350	1	D-40836
6.5	100	60	1	D-40842
6.5	150	100	1	D-40858
6.5	400	350	1	D-40864
7	400	350	1	D-40892
8	400	350	1	D-40939
10	150	100	1	D-40967
10	200	130	1	D-40973
10	400	350	1	D-40989
12	200	130	1	D-41012
12	400	350	1	D-41028

T.C.T drill bit set with Straight shank/ Brick



Bit Dia (mm)	Length (mm)	Working Length (mm)	Part No.
5	85	55	D-41034
6	100	60	
8	120	80	

TCT drill bit with Straight shank / Multi material 5pcs. assortment



* 5 different sizes

Bit Dia (mm)	Length (mm)	Part No.
4	75	E-14255
5	85	
6	100	
8	120	
10	150	

T.C.T drill bit with Straight shank/ Two-star



Bit Dia (mm)	Length (mm)	Working Length (mm)	Sales Pkg Qty	Part No.
3	60	30	1	D-05228
4	70	35	1	D-05234
5	85	45	1	D-05240
6	100	60	1	D-05256
6	150	90	1	D-05262
7	100	55	1	D-05278
7	150	90	1	D-05284
8	110	60	1	D-05290
8	150	90	1	D-05309
9	150	90	1	D-05315
10	150	90	1	D-05321
11	150	90	1	D-05337
12	150	90	1	D-05343
13	150	85	1	D-05359
16	150	85	1	D-05387

T.C.T drill bit 5 pcs set with Straight shank/ Two-star



* 5 different sizes

Bit Dia (mm)	Length (mm)	Working Length (mm)	Part No.
4	70	35	E-11536
5	85	45	
6	100	60	
8,10	110	60	D-20719
5, 6, 7, 8, 10	110	60	



Drilling (Masonry)

T.C.T drill bit with 1/4" Hex shank



Type NZ

Diameter (mm)	Length (mm)	Working Length (mm)	Sales Pkg Qty	Part No.
3	80	35	1	D-31463
4	80	35	1	D-31479
6	100	55	1	D-31491
8	100	55	1	D-31500

Glass bit with straight shank



Diameter (mm)	Length (mm)	Sales Pkg Qty	Part No.
3	65	1	D-25111
4	65	1	D-25127
5	65	1	D-25133
6	65	1	D-25149
8	70	1	D-25155
10	80	1	D-25161
12	80	1	D-25177

Glass bit with 1/4" Hex shank



1/4"Hex (NZ)

Diameter (mm)	Length (mm)	Sales Pkg Qty	Part No.
4	65	1	D-31413
5	65	1	D-31429
6	65	1	D-31435
8	70	1	D-31441
10	80	1	D-31457

T.C.T drill bit with Straight shank/ Omnibohrer



Bit Dia (mm)	Length (mm)	Working Length (mm)	Sales Pkg Qty	Part No.
3	60	28	1	D-30287
4	70	35	1	D-30293
5	85	43	1	D-30302
5.5	85	43	1	D-31027
5.5	100	58	1	D-31033
5.5	150	108	1	D-31049
6	100	58	1	D-30318
6	150	108	1	D-30324
6.5	85	43	1	D-31055
6.5	100	58	1	D-31061
6.5	150	108	1	D-31077
7	100	53	1	D-30330
7	150	108	1	D-30346
8	110	57	1	D-30352
8	150	97	1	D-30368
9	150	97	1	D-30374
10	150	97	1	D-30380
10	400	300	1	D-30396
11	150	91	1	D-30405
12	150	91	1	D-30411
12	400	298	1	D-30427
12	600	500	1	D-30433
13	150	85	1	D-30449
14	150	85	1	D-30455
14	400	300	1	D-30461

T.C.T drill bit 5 pcs set with Straight shank/ Omnibohrer















* 5 different sizes

Bit Dia (mm)	Length (mm)	Working Length (mm)	Part No.
4	70	35	D-36712
5	85	43	
6	100	58	
8,10	150	97	D-30477
5	85	43	
6	100	58	
8	110	57	
10,12	150	97	

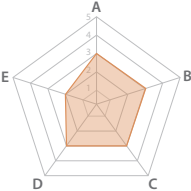
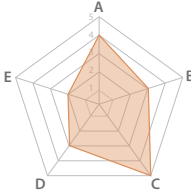
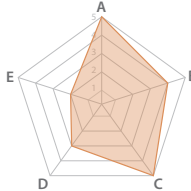
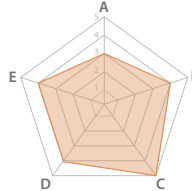
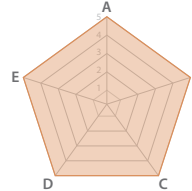
Drilling (Masonry)

T.C.T drill bit for SDS-PLUS Hammers













Product	Standard type	Centering Tip	Centering Tip V-PLUS	4 cutter	NEMESIS II
Range	★ ★	★ ★ ★	★ ★ ★ ★	★ ★ ★	★ ★ ★ ★ ★
Carbide					
Tip	2 Cutter	Centering tip 2 Cutter	Centering tip 2 Cutter	Centering tip 4 Cutter	*Full carbide tip 4 Cutter 
Flute	Standard 2 flute	Standard 2 flute	High Durability 2 flute	Standard 2 flute	High Durability 4 flute
Size	3.5 - 30mm 5/32" - 1"	4 - 32mm 5/32" - 1"	3.5-26mm	5 - 25mm	5 - 32mm 5/32" - 1-1/4"
Chart					
Work material					

*Full carbide spec is only for dia. 5 to 16mm

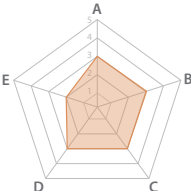
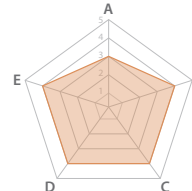
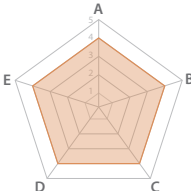
T.C.T drill bit for SDS-MAX Hammers



Product	Standard type	4 cutter	NEMESIS	Mining
Range	★ ★	★ ★ ★	★ ★ ★ ★	Specialized
Carbide				
Tip	2 Cutter	Centering tip 4 cutter	Centering tip 4 Cutter 	4 Cutter 
Flute	Standard 2 flute	Standard 2 flute	High Durability 4 flute	High Durability 2 flute
Size	12-40mm 1/2" - 1-1/2"	12-30mm	12-40mm 1/2" - 1-1/2"	28-32mm
Chart				Specialized
Work material				

Drilling (Masonry)

T.C.T drill bit for SDS-PLUS hammers



Diameter (mm)	Length (mm)	Working Length (mm)	Sales Pkg Qty	Part No.
3.5	110	50	1	D-15665
4	110	50	1	D-00016
4	160	100	1	D-66612
5	110	50	1	D-00022
5	160	100	1	D-00038
5	210	150	1	D-66628
5.5	110	50	1	D-00044
5.5	160	100	1	D-16106
6	110	50	1	D-00050
6	160	100	1	D-00066
6	210	150	1	D-00072
6.5	110	50	1	D-00088
6.5	160	100	1	D-00094
6.5	210	150	1	D-45082
6.5	260	200	1	D-66634
7	110	50	1	D-00103
7	160	100	1	D-00119
8	110	50	1	D-00125
8	160	100	1	D-00131
8	210	150	1	D-00147
8	260	200	1	D-00153
8	310	250	1	D-66640
9	110	50	1	D-08040
9	160	100	1	D-08056
9	210	150	1	D-00169
10	110	50	1	D-09117
10	160	100	1	D-00175
10	210	150	1	D-00181
10	260	200	1	D-00197
10	310	250	1	D-00206
10	350	290	1	D-66656
10.5	160	100	1	D-01127
11	160	100	1	D-00212
11	210	150	1	D-66662
11	260	200	1	D-66678
12	160	100	1	D-00228
12	210	150	1	D-00234
12	260	200	1	D-00240
12	310	250	1	D-66684
12	350	290	1	D-16112
12	460	400	1	D-16271
12.5	160	100	1	D-14102
12.7	160	100	1	D-03280
12.7	350	290	1	D-03296
13	160	100	1	D-00256
13	210	150	1	D-66690
13	260	200	1	D-25622

Diameter (mm)	Length (mm)	Working Length (mm)	Sales Pkg Qty	Part No.
13	350	290	1	D-16128
14	160	100	1	D-00262
14	210	150	1	D-21331
14	260	200	1	D-00278
14	310	250	1	D-66709
14	350	290	1	D-16134
14	460	400	1	D-17544
14.3	160	100	1	D-03997
15	160	100	1	D-00284
15	350	290	1	D-16140
16	160	100	1	D-03981
16	210	150	1	D-00290
16	260	200	1	D-16156
16	310	250	1	D-00309
16	350	290	1	D-16162
16	460	400	1	D-16287
17	160	100	1	D-16178
17	210	150	1	D-00315
17	350	290	1	D-16190
17.5	160	100	1	D-03305
18	160	100	1	D-16209
18	210	150	1	D-00321
18	260	200	1	D-16215
18	300	240	1	D-00337
18	350	290	1	D-16221
18	460	400	1	D-17566
19	210	150	1	D-00343
19	350	290	1	D-16243
20	210	150	1	D-00359
20	260	200	1	D-16259
20	310	250	1	D-00365
20	350	290	1	D-16265
20	460	400	1	D-15235
22	260	200	1	D-00371
22	310	250	1	D-08062
22	460	400	1	D-15241
24	460	400	1	D-16302
25	260	200	1	D-00387
25	310	250	1	D-08517
25	350	290	1	D-03311
25	460	400	1	D-15257
26	260	200	1	D-00393
26	310	250	1	D-08078
26	460	400	1	D-15263
28	460	400	1	D-16318

Drilling (Masonry)

T.C.T drill bit for SDS-PLUS hammers/ Dustless



Bit Dia (mm)	Length (mm)	Working Length (mm)	Sales Pkg Qty	Part No.
12	325	200	1	B-64381
14	360	240	1	B-64397
16	360	240	1	B-64406
18	360	240	1	B-64412

T.C.T drill bit for SDS-PLUS hammers/V-PLUS



V-PLUS



Bit Dia (mm)	Length (mm)	Working Length (mm)	Sales Pkg Qty	Part No.
4	110	50	1	B-47232
7	160	100	1	B-47444
8	210	150	1	B-47472
9	160	100	1	B-47531
10	450	390	1	B-47606
12	26	210	1	B-47690
12	450	400	1	B-47721
14	160	110	1	B-46589
14	450	400	1	B-47830
15	450	400	1	B-47896
16	310	260	1	B-47933
16	450	400	1	B-47949
18	300	250	1	B-48016
18	450	400	1	B-48022
20	450	400	1	B-48094
25	450	400	1	B-48234
26	450	400	1	B-48278



T.C.T drill bit for SDS-PLUS hammers/ Centering tip



Bit Dia (mm)	Length (mm)	Working Length (mm)	Sales Pkg Qty	Part No.
4	110	50	1	B-55859
5	110	50	1	B-54128
5	160	100	1	B-54134
5.5	110	50	1	B-55865
5.5	160	100	1	B-55871
6	110	50	1	B-54140
6	160	100	1	B-54156
6	210	150	1	B-54162
6.5	110	50	1	B-55887
6.5	160	100	1	B-55893
7	110	50	1	B-55924
8	110	50	1	B-54178
8	160	100	1	B-54184
8	210	150	1	B-55952
8	260	200	1	B-55968
9	160	100	1	B-55974
10	110	50	1	B-55980
10	160	100	1	B-54190
10	210	150	1	B-54209
10	260	200	1	B-55996
10	310	250	1	B-56007
12	160	100	1	B-54215
12	210	150	1	B-54221
12	260	200	1	B-56029
12	350	290	1	B-56035
13	160	100	1	B-56057
14	160	100	1	B-56063
14	260	200	1	B-56085
14	350	290	1	B-56091
16	160	100	1	B-56116
16	210	150	1	B-56122
16	310	250	1	B-56138
16	350	290	1	B-56144
16	450	400	1	B-56150
17	210	140	1	B-56465
18	210	150	1	B-62125
18	350	290	1	B-62131
19	210	150	1	B-62147
20	210	150	1	B-62169
20	350	290	1	B-62175
22	210	150	1	B-62181
22	350	290	1	B-62197
25	210	150	1	B-62228
25	350	290	1	B-62234

Drilling (Masonry)

T.C.T drill bit set for SDS-PLUS hammers

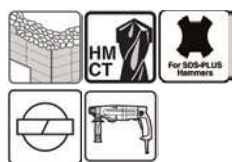

Bit Dia (mm)	Length (mm)	Working Length (mm)	Part No.
5, 6, 8	110	50	D-00795
6, 8	160	100	
5.5, 7	110	50	D-03888
6, 7, 8	160	100	
6, 6.5	110	50	D-17784
8, 10, 12	160	100	
5, 6, 7, 8, 10	160	100	D-20703

T.C.T drill bit set for SDS-PLUS hammers/ Aluminum case



6pc. assortment

Description	Part No.
5, 6, 8 x 160	D-58920
Bull Point 250	
Cold Chisel 20x250	
Scaling Chisel 40x250	

10pc. assortment

Description	Part No.
6 x 110, 8 x 160, 10, 12 x 210, 10, 12, 16, 20 x 460	D-19174
Bull Point 250	
Cold Chisel 20 x 250	

17pc. assortment

Description	Part No.
5, 6, 8, 10 x 110, 6, 8, 10, 12 x 160, 8, 10 x 210, 12, 14 x 260	D-19180
Bull Point 140, 250	
Cold Chisel 20x140, 20 x 250	
Scaling Chisel 40 x 250	

T.C.T drill bit for SDS-PLUS hammers/ 4 cutter



Bit Dia (mm)	Length (mm)	Working Length (mm)	Sales Pkg Qty	Part No.
5	110	50	1	B-68127
5	160	100	1	B-68133
5	210	150	1	B-68149
5	260	200	1	B-68155
6	110	50	1	B-62496
6	160	100	1	B-62505
6	210	150	1	B-62511
6	260	200	1	B-62527
6	310	250	1	B-68161
6.5	110	50	1	B-62533
6.5	160	100	1	B-62549
6.5	210	150	1	B-62555
6.5	260	200	1	B-62561
7	110	50	1	B-62577
7	160	100	1	B-62583
7	210	150	1	B-62599
8	110	50	1	B-62608
8	160	100	1	B-62614
8	210	150	1	B-62620
8	260	200	1	B-62636
8	310	250	1	B-62642
8	460	400	1	B-62658
10	110	50	1	B-62664
10	160	100	1	B-62670
10	210	150	1	B-62686
10	260	200	1	B-62692
10	310	250	1	B-62701
10	350	290	1	B-62717
10	460	400	1	B-62723
12	160	100	1	B-62739
12	210	150	1	B-62745
12	260	200	1	B-62751
12	310	250	1	B-62767
12	350	290	1	B-62773
12	460	400	1	B-62789
14	160	100	1	B-62795
14	210	150	1	B-62804
14	260	200	1	B-62810
14	310	250	1	B-62826
14	350	290	1	B-62832
14	460	400	1	B-62848
16	160	100	1	B-62854
16	210	150	1	B-62860
16	260	200	1	B-62876
16	310	250	1	B-62882
16	350	290	1	B-62898
16	460	400	1	B-62907
18	260	200	1	B-68177
18	460	400	1	B-68236
20	260	200	1	B-68183
20	460	400	1	B-68242
22	260	200	1	B-68199
22	460	400	1	B-68258
25	260	200	1	B-68208
25	460	400	1	B-68264

MAKPAC 65pcs. Set for SDS-PLUS

HSS-TiN drill bit for SDS-PLUS x8pcs. Wood drill bit for SDS-PLUS x5pcs, Masonry drill bit for SDS-PLUS x5pcs, Screw bit 25mm x40pcs., Nutsetter x4pcs. Countersink, Sleeve chuck bit holder for SDS-PLUS, Tape Measure 3m



Metric size

Part No.

B-69478

NEMESIS II



	Hole	Tungsten carbide tip

The drilling hole is closer to a circle than 2cutter.
Lifetime is longer than 2cutter because of big TCT.

Centering tip
Stable and secure drilling

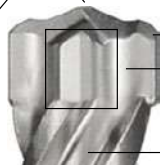

Wearing mark
Indicator for evaluating the dimensional stability of the anchor holes

Innovated flute geometry
Faster drilling

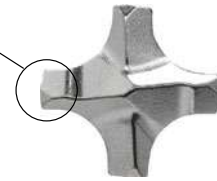

Rebar chamfer
Reduce shock in reinforcement strikes

Solid TCT (5 - 10mm)
One piece TCT (11 - 16mm)
Three piece TCT (18 - 32mm)

T.C.T drill bit for SDS-PLUS hammers/ Nemesis II



NEMESIS II



Bit Dia (mm)	Length (mm)	Working Length (mm)	1pc.	5pcs.	10pcs.
			Part No.	Part No.	Part No.
5	115	50	B-57897	B-58796	B-63214
5	165	100	B-57906	-	B-63220
5.5	115	50	B-57940	B-58805	B-63236
5.5	165	100	B-57956	-	B-63242
6	115	50	B-57962	B-58811	-
6	165	100	B-57978	B-58827	B-63264
6	215	150	B-57984	-	-
6	265	200	B-57990	-	-
6	315	250	B-58001	-	-
6.5	165	100	B-58023	B-58849	B-63301
6.5	215	150	B-58039	-	-
6.5	265	200	B-58045	-	-
6.5	315	250	B-58051	-	-
7	115	50	B-58067	-	-
7	165	100	B-58073	-	-
8	115	50	B-58095	B-58883	-
8	165	100	B-58104	B-58899	B-63373
8	215	150	B-58110	-	-
8	265	200	B-58126	-	-
8	315	250	B-58132	-	-
9	165	100	B-58176	-	-
10	115	50	B-58198	-	-
10	165	100	B-58207	B-58914	B-63410
10	215	150	B-58213	B-58920	B-63426
10	265	200	B-58229	-	-
10	315	250	B-58235	-	-
10	455	390	B-58257	-	-
10	600	540	B-58263	-	-
10	1000	940	B-58279	-	-

Bit Dia (mm)	Length (mm)	Working Length (mm)	1pc.	5pcs.	10pcs.
			Part No.	Part No.	Part No.
12	160	110	B-58322	B-58936	B-63454
12	210	160	B-58338	B-58942	B-63460
12	260	210	B-58344	-	-
12	310	260	B-58350	-	-
12	450	400	B-58366	-	-
12	600	550	B-58372	-	-
12	1000	950	B-58388	-	-
14	160	110	B-58431	-	-
14	210	160	B-58447	-	-
14	260	210	B-58453	-	-
14	310	260	B-58469	-	-
14	450	400	B-58475	-	-
14	600	550	B-58481	-	-
14	1000	950	B-58497	-	-
15	160	110	B-58506	-	-
15	210	160	B-58512	-	-
15	260	210	B-58528	-	-
15	450	400	B-58534	-	-
16	160	110	B-58540	-	-
16	210	160	B-58556	-	-
16	260	210	B-58562	-	-
16	310	260	B-58578	-	-
16	450	400	B-58584	-	-
16	600	550	B-58590	-	-
16	1000	950	B-58609	-	-
18	250	200	B-58615	-	-
18	450	400	B-58621	-	-
20	250	200	B-58637	-	-
20	450	400	B-58659	-	-
22	250	200	B-58665	-	-
22	450	400	B-58687	-	-
24	250	200	B-58693	-	-
24	450	400	B-58702	-	-
25	250	200	B-58718	-	-
25	450	400	B-58724	-	-
28	450	400	B-58752	-	-
30	450	400	B-58774	-	-
32	450	400	B-58780	-	-

Drilling (Masonry)

Nemesis II SDS-Plus Hammer Assortment Set



Bit Dia (mm)	Length (mm)	Working Length (mm)	Part No.
5,6	110	60	B-58992
6,8,10	160	110	

HSS-TiN impact drill bit for SDS-PLUS Hammers



Two- star range



Type NZ

Diameter (mm)	Length (mm)	Working Length (mm)	Sales Pkg Qty	Part No.
3	90	33	1	B-57401
3.5	100	39	1	B-57417
4	105	43	1	B-57423
4.5	110	47	1	B-57439
5	116	52	1	B-57445
5.5	123	57	1	B-57451
6	12	57	1	B-57467
6.5	131	63	1	B-57473

Wood drill bit for SDS-PLUS Hammers



Diameter (mm)	Length (mm)	Working Length (mm)	Sales Pkg Qty	Part No.
4	105	43	1	B-57489
5	116	52	1	B-57495
6	123	57	1	B-57504
8	147	75	1	B-57510
10	163	87	1	B-57526

SDS-PLUS Sleeve chuck bit holder



Size (mm)	Sales Pkg Qty	Part No.
80	1	B-57548

T.C.T drill bit for SDS-MAX hammers/ Nemesis



Bit Dia (mm)	Length (mm)	Working Length (mm)	Sales Pkg Qty	Part No.
16	340	200	1	B-19962
16	540	400	1	B-19978
18	340	200	1	B-19990
18	540	400	1	B-20002
20	320	200	1	B-20024
20	520	400	1	B-20030
22	520	400	1	B-20068
25	520	400	1	B-20111
25	920	800	1	B-20127
28	370	250	1	B-20149
28	570	450	1	B-20155
30	570	450	1	B-20199
32	570	450	1	B-20214
35	570	450	1	B-20242
40	570	450	1	B-20301

T.C.T drill bit for SDS-MAX hammers



Bit Dia (mm)	Length (mm)	Working Length (mm)	Sales Pkg Qty	Part No.
12	340	200	1	D-33875
14	340	200	1	D-33897
14	540	400	1	D-33906
15	340	200	1	D-33912
16	340	200	1	D-33934
16	540	400	1	D-33940
18	340	200	1	D-33956
18	540	400	1	D-33962
20	540	400	1	D-33984
20	340	200	1	D-33978
22	340	200	1	D-33990
22	540	400	1	D-34001
24	340	200	1	D-34017
24	540	400	1	D-34023
25	340	200	1	D-34039
25	540	400	1	D-34045
28	370	250	1	D-34051
28	570	450	1	D-34067
30	370	250	1	D-34073
30	570	450	1	D-34089
32	370	250	1	D-34095
32	570	450	1	D-34104
35	370	250	1	D-34110
35	570	450	1	D-34126
38	370	250	1	D-34132
38	570	450	1	D-34148
40	370	250	1	D-34154
40	570	450	1	D-34160

Drilling (Masonry)

T.C.T drill bit for SDS-MAX hammers



Bit Dia (mm)	Length (mm)	Working Length (mm)	Sales Pkg Qty	Part No.
28	670	550	1	B-39431
30	720	600	1	B-39447
32	570	450	1	B-39453
32	920	800	1	B-39469

Concrete core cutter for SDS-MAX hammers



Bit Dia (mm)	Length (mm)	Sales Pkg Qty	Part No.
40	550	1	B-57629
45	550	1	B-57635
45	990	1	B-57641
55	550	1	B-57657
55	990	1	B-57663
65	550	1	B-57679
65	990	1	B-57685
80	550	1	B-57691
80	990	1	B-57700

T.C.T drill bit for SDS-MAX hammers/ Mining



Bit Dia (mm)	Length (mm)	Working Length (mm)	Sales Pkg Qty	Part No.
32	570	450	1	B-14613
32	920	800	1	B-15045

T.C.T drill bit for 17mm Hex shank hammers











Bit Dia (mm)	Length (mm)	Sales Pkg Qty	Part No.
16	280	1	D-20127
16	505	1	D-20133
18	280	1	D-20149
18	505	1	D-20155
19	280	1	D-20161
19	505	1	D-20177
20	280	1	D-20183
20	505	1	D-20199
22	280	1	D-20208
22	505	1	D-20214
25.5	280	1	D-20220
25.5	505	1	D-20236
28	280	1	D-20242
28	505	1	D-20258
32	505	1	D-20270
35	505	1	D-20292



Drilling (Masonry)

Chisels

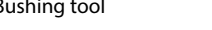

Shape	Application	For SDS-PLUS Hammers	For SDS-MAX Hammers	17mm Hex	19mm Hex	21mm Hex	28.6mm Hex	30mm Hex	Makita Small
Bull point 	Demolition and adjustment work in masonry and concrete. Chipping and breaking in masonry and concrete. Starts holes in concrete.	●	●	●	●	●	●	●	●
Cold chisel 	Adjustment work in masonry and concrete. Chipping, breaking, edging and channeling in masonry and concrete.	●	●	●	●	●	●	●	
Grooving chisel 	Cutting channels in concrete.	●	●	●					
Scaling chisel 	Removing concrete residues.	●	●	●	●	●	●	●	●
Clay spade 	Digging in clay, hard gravel, hard packed gravel, soil and dirt.		●	●		●		●	
Rammer 	Tamping asphalt and compacting gravel, soil and dirt.		●	●	●	●		●	
Bushing tool 	Roughing concrete and asphalt up.		●	●		●			
Scraper 	Scraping floor tiles, linoleum floor and clean-up.	●							●

Drilling (Masonry)

Bull point for SDS-PLUS hammers



Length (mm)	Sales Pkg Qty	Part No.
160	1	D-08034
250	1	D-08713

Bull point for SDS-PLUS hammers/ Premium



Length (mm)	Sales Pkg Qty	Part No.
250	1	B-64238

Cold chisel for SDS-PLUS hammers



Size (mm)	Sales Pkg Qty	Part No.
20 x 160	1	D-71255
20 x 230	1	D-71261
20 x 250	1	D-08729
20 x 400	1	D-19021

Cold chisel for SDS-PLUS hammers/ Premium



Size (mm)	Sales Pkg Qty	Part No.
20 x 250	1	B-64244

Scaling chisel for SDS-PLUS hammers



Size (mm)	Sales Pkg Qty	Part No.
40 x 250	1	D-08735
50 x 215	1	D-25616

Scaling chisel for SDS-PLUS hammers/ Premium



Size (mm)	Sales Pkg Qty	Part No.
40 x 250	1	B-64250

Scraper Assembly for SDS-PLUS hammers



Length(mm)	Type	Part No.
100 x 160	-	A-68161
100	Cutter	343411-9

Chisel set for SDS-PLUS hammers



Description	Part No.
Bull Point 230	D-71314
Cold Chisel 20 x 230	
Scaling Chisel 40 x 230	

Drilling (Masonry)

Chisel set for SDS-PLUS hammers/ Aluminum case



3pc. assortment

Description	Part No.
Bull Point 250	D-05181
Cold Chisel 20 x 250	
Scaling Chisel 40 x 250	

4pc. assortment

Description	Part No.
Bull Point 250	D-08757
Cold Chisel 20 x 250	

5pc. assortment

Description	Part No.
Bull Point 250	D-16368
Cold Chisel 20 x 250	
Scaling Chisel 40 x 250	

T.C.T drill bit & chisel set for SDS-PLUS hammers/ Aluminum case in Makita blue



10pc. assortment

Description	Part No.
5x160, 6x160, 8x160, 10x160, 12x160, 10x210, 12x210, 16x210	D-71990
Bull Point 250	
Cold Chisel 20x250	

18pc. assortment

Description	Part No.
5 x 110, 6 x 110, 8 x 110, 10 x 110, 6 x 160, 8 x 160, 10 x 160, 12 x 160, 8 x 210, 10 x 210, 10 x 260, 12 x 260	D-71180
Bull Point 140, 250	
Cold Chisel 20x140, 20x250	
Scaling Chisel 40x250	
Drill Chuck & Chuck Key 13mm	

Self sharpening bull point



Feature

Unique star-shape design keeps always sharp

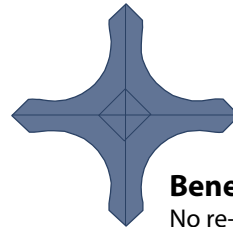
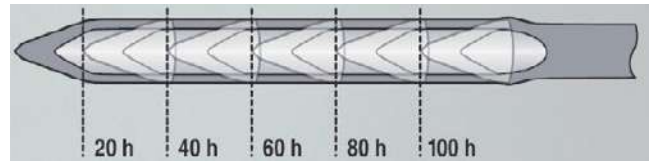

Benefit

No re-sharpening necessary
No work interruption due to resharpening
No service costs

Bull point for SDS-MAX hammers/ Self-sharpening

Self sharpening



Length (mm)	Sales Pkg Qty	Part No.
400	1	E-13172

Cold chisel for SDS-MAX hammers/ Premium



Size (mm)	Sales Pkg Qty	Part No.
25 x 400	1	B-64272

Bull point for SDS-MAX hammers/ Premium



Length (mm)	Sales Pkg Qty	Part No.
400	1	B-64266

Drilling (Masonry)

Bull point for SDS-MAX hammers



Length (mm)	Sales Pkg Qty	Part No.
280	1	A-80787
300	1	D-34176
400	1	A-80793
400	1	D-34182
600	1	D-34198

Cold chisel for SDS-MAX hammers



Size (mm)	Sales Pkg Qty	Part No.
25 x 280	1	A-80802
25 x 300	1	D-34207
25 x 400	1	A-80818
25 x 400	1	D-34213

Scaling chisel for SDS-MAX hammers



Size (mm)	Sales Pkg Qty	Part No.
50 x 400	1	A-80824
50 x 400	1	B-64288
50 x 400	1	D-34235

Scaling chisel for SDS-MAX hammers/ Tile



Size (mm)	Sales Pkg Qty	Part No.
50 x 300	1	A-80830

Ground rod driver for SDS-MAX hammers

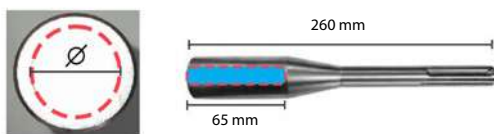

Diameter Size (Inside)(mm)	Shank	Part No.
13.3	SDS-MAX	E-13029
16.5		E-13035
22.2		E-13041

Clay spade for SDS-MAX hammers



Size (mm)	Sales Pkg Qty	Part No.
105 x 400	1	A-17653

Rammer for SDS-MAX hammers

Use with shank (A-19897)

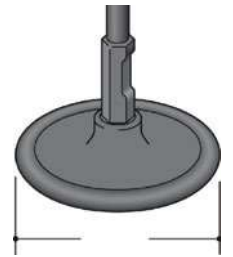

Size (mm)	Sales Pkg Qty	Part No.
140	1	A-19875

Bushing tool for SDS-MAX hammers

Use with shank (A-19897)



Size (mm)	Sales Pkg Qty	Part No.
60 x 60 x 50	1	A-19881

Shank adapter for SDS-MAX hammers

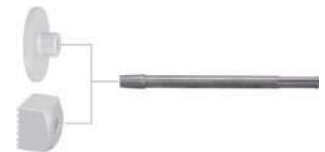

Size (mm)	Sales Pkg Qty	Part No.
250	1	A-19897

SDS Max to SDS Plus adaptor

MAX



18mm



PLUS



10mm



Size (mm)	Sales Pkg Qty	Part No.
220	1	P-17027

Drilling (Masonry)

Chisel set for SDS-MAX hammers/ Aluminum case



4pc. assortment

Description	Part No.
Bull Point 300, 400	D-40559
Cold Chisel 25 x 300, 25 x 400	

Chisel set for SDS-MAX hammers/ Aluminum case in Makita blue



5pc. assortment

Description	Part No.
Bull Point 400	D-42472
Cold Chisel 25 x 400	

Bull point for 17mm Hex shank hammers



Size (mm)	Sales Pkg Qty	Part No.
255	1	D-71283
280	1	D-08682
450	1	D-16863

Bull point for 17mm Hex shank hammers/ Sharper edge



Size (mm)	Sales Pkg Qty	Part No.
280	1	D-26303
450	1	D-29860



Cold chisel for 17mm Hex shank hammers



Size (mm)	Sales Pkg Qty	Part No.
17 x 280	1	A-80569
19 x 210	1	D-26587
19 x 280	1	D-08707
19 x 450	1	D-16879
22 x 255	1	D-71299

Drilling (Masonry)

Scaling chisel for 17mm Hex shank hammers



Size (mm)	Sales Pkg Qty	Part No.
50 x 280	1	A-80606
50 x 280	1	D-20694
50 x 450	1	D-52548

Grooving chisel for 17mm Hex shank hammers



Size (mm)	Sales Pkg Qty	Part No.
22 x 280	1	A-48555
26 x 280	1	A-48561

Chisel set for 17mm Hex shank hammers



Description	Description	Each	Sum	Part No.
Bull Point	255	1	3	D-71320
Cold Chisel	22 x 255	1		
Scaling Chisel	40 x 255	1		

Bushing tool for 17mm Hex shank hammers



Size (mm)	Length (mm)	Sales Pkg Qty	Part No.
60 x 60	270	1	A-21484

Bull point for 21mm Hex shank hammers



Length (mm)	Sales Pkg Qty	Part No.
320	1	D-16499
450	1	D-23824
600	1	D-30994

Cold chisel for 21mm Hex shank hammers



Size (mm)	Sales Pkg Qty	Part No.
26 x 320	1	D-17588
26 x 450	1	D-17594

Scaling chisel for 21mm Hex shank hammers



Size (mm)	Sales Pkg Qty	Part No.
70 x 320	1	D-20672



Bull point for 28.6mm Hex shank hammers



Size (mm)	Sales Pkg Qty	Part No.
350	1	D-65034
410	1	D-17631

Bull point for 28.6mm Hex shank hammers/ Self-sharpening

Self sharpening



Length (mm)	Sales Pkg Qty	Part No.
320	1	D-16499
450	1	D-23824
600	1	D-30994



Length (mm)	Sales Pkg Qty	Part No.
400	1	B-10372

Drilling (Masonry)

Cold chisel for 28.6mm Hex shank hammers



Size (mm)	Sales Pkg Qty	Part No.
28x410	1	D-17647

Scaling chisel for 28.6mm Hex shank hammers



Size (mm)	Sales Pkg Qty	Part No.
75x410	1	D-29228

Bull point for 30mm Hex shank hammers



Length (mm)	Sales Pkg Qty	Part No.
335	1	D-15285

Cold chisel for 30mm Hex shank hammers



Size (mm)	Sales Pkg Qty	Part No.
30x400	1	D-15300

Scaling chisel for 30mm Hex shank hammers



Size (mm)	Sales Pkg Qty	Part No.
75x310	1	D-23868

Bull point for Makita small shank

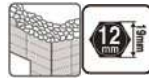

Length (mm)	Sales Pkg Qty	Part No.
220	1	B-06921

Scaling chisel for Makita small shank



Size (mm)	Sales Pkg Qty	Part No.
30x150	1	B-07331
50x150	1	B-07347

Scraper Assembly for Makita small shank



Length (mm)	Type	Part No.
100x160	-	A-68155
100	Cutter	343411-9



ACCESSORIES

Fastening

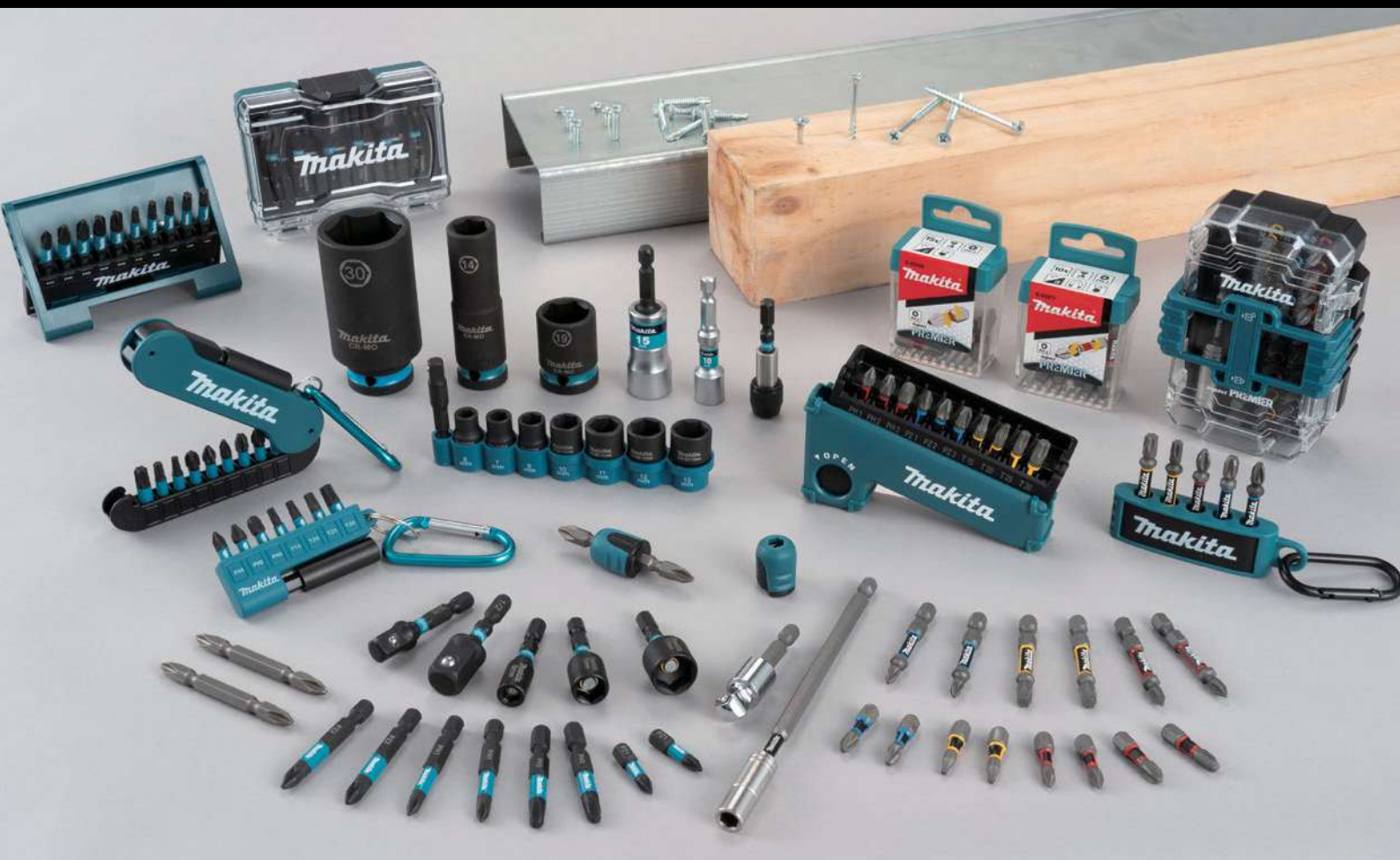

Wood



Magnet



Double end



Flexible



1/2inch SQ



6.35hex shank MZ



6.35hex shank NZ



6.35hex shank C form



Hex shank



Pin ring



CR-MO

Drilling (Fastening)

Fastener drive and screwdriving series

<p>1. C-form</p> 	
<p>2. E-form</p> 	
<p>3. Double ended</p> 	
<p>4. Bit holder</p> 	
<p>5. Nutsetter</p> 	
<p>6. Assortment</p> 	
<p>7. Socket adapter / Socket bit</p> 	
<p>8. Impact socket</p> 	
<p>9. Other</p> 	

Impact

PREMIER

*Double Torsion
for High Durability.*



*New Steel
is Used.
Supports High Torque.*

*High Precision
Screw Fitting.*

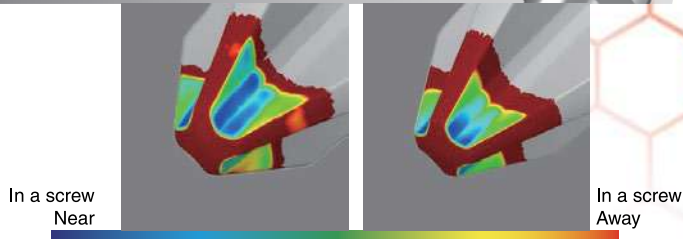
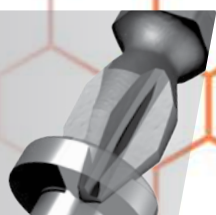

**Impact
PREMIER**

STANDARD

Torque

Angle



**PREMIER
ALLOY**

- IMPACT PREMIER
- IMPACT GOLD
- STANDARD





NEW INNOVATION









Drilling (Fastening)

Screw Bit

1/4" Hex Shank (C-form)		
A	C-form	

1/4" Hex Shank (E-form)	NZ	MZ
E-form (Single Ended)	14mm 	9.5mm 
E-form (Double Ended)	17mm 	11mm 



Drive type

Philips (PH)	PZ	Hex (H)	T	TH	Square (SQ)	Slotted (SL)
						

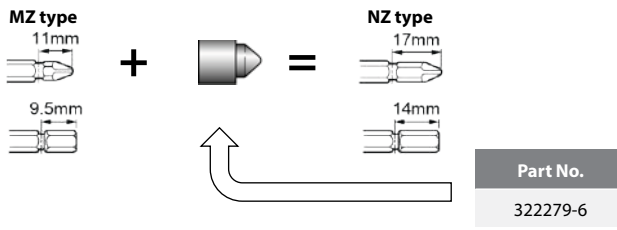
Bit piece for screwdriver & impact driver





Magnetic bit holder for screwdriver



Shank Type	Length (mm)	Sales Pkg Qty	Part No.
E-form (MZ)	60	1	784811-8
	76	1	784801-1

Flexible bit holder



Shank Type	Overall Length (mm)	Sales Pkg Qty	Part No.
1/4 Inch Hex	300	1	B-29094

Flexible tough bit holder

Shank Type	Overall Length (mm)	Sales Pkg Qty	Part No.
E-form (NZ)	300	1	B-51851

Screw bit for screwdriver (E-form)



Size	Shank Type	Length (mm)	Sales Pkg Qty	Part No.
	E-form (NZ)	117	5	A-12697
		122	5	A-45858
		132	5	A-16536
		162	5	B-10481
		182	5	B-10475



Screw bit blister 3pcs set (C-form)



Size	Shank Type	Length (mm)	Sales Pkg Qty	Part No.	
	PH 2	C-form	25	3	B-23466

Screw bit blister 1pc, 3pcs set (E-form)

Size	Shank Type	Length (mm)	Sales Pkg Qty	Part No.	
	PH 1	50	3	B-25030	
		50		B-25046	
	E-form (NZ)	H3		50	D-74930
		H4		50	D-74946
		H5		50	D-74952
		H6		50	D-74968
		H3		90	D-74974
		H4		90	D-74980
		H5		90	D-74996
		H6		90	D-75007
		H3		150	D-75013
		H4		150	D-75029
		H5	150	D-75035	
		H6	150	D-75041	

Drilling (Fastening)



Torsion screw bit C-form Impact PREMIER with bit holder Assortment



Shank Type	Sales Pkg Qty	Part No.
C-form & E-form (MZ)	11	E-03567

Mag boost Impact PREMIER



Range	Sales Pkg Qty	Part No.
★★★★★	1	E-03442

Socket Adapter set

It allows impact driver to fasten or loosen bolt and nut.
8,10,12,13,14,15,17,18mm
Socket adapter 50mm

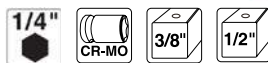

Size	Shank Type	Sales Pkg Qty	Part No.
SQ 1/2"	NZ-B	1	B-55762
SQ 1/4"	NZ-B	1	E-14336



Impact BLACK screw bit set



Shank Type	Sales Pkg Qty	Part No.
C-form & E-form (NZ)	8	E-14227
E-form (NZ)	10	E-14233
C-form & E-form (NZ)	33	E-06622

Double ended screw bit E-form Impact BLACK

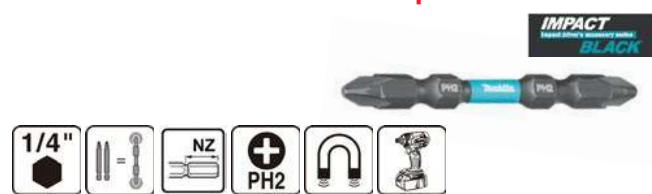

Bit Type	Shank Type	Length (mm)	Sales Pkg Qty	Part No.
PH2	E-form (NZ)	65	10	E-15827
PH2	E-form (NZ)	110	10	E-15833

Screw bit E-form Impact BLACK



Bit Type	Shank Type	Length (mm)	Sales Pkg Qty	Part No.
PH2	E-form (NZ)	50	2	E-08763

Magnetic bit holder E-form Impact BLACK



Shank Type	Length (mm)	Sales Pkg Qty	Part No.
E-form (NZ)	60	1	E-08785

Drilling (Fastening)

Socket adapter E-form Impact BLACK



Bit Type	Shank Type	Length (mm)	Sales Pkg Qty	Part No.
1/2 inch Drive	E-form (NZ)	50	1	E-08850

43pcs. Color screw bit set / Clamshell

Magnetic nutsetter 6,8,10mm
Sleeve chuck bit holder 60mm
Screw guide bit holder 80mm



Shank Type	Sales Pkg Qty	Part No.
C-form & E-form	43	B-55697

31pcs. Screw bit set / Clamshell

Case set with more compact and cost-performance

- ⊕PH0, PH1,4xPH2,,PH3 x 25mm, ⊕PZ0, PZ1, 4xPZ2, PZ3 x 25mm
- ⊖SL4.5,SL5.5, SL6.5 x 25mm , ⊕T10,T15, 2xT20, 2xT25, T27 ,T30, T40 x 25mm,
- H3,H4,H5,H6 x 25mm, Sleeve chuck bit holder



Shank Type	Part No.
C-form & E-form (MZ)	B-69901

Screw bit & socket with Ratchet handle 21pcs set

Ratchet handle is convenient for screwing in narrow place hard to reach



Shank Type	Sales Pkg Qty	Part No.
C-form & E-form (MZ)	21	B-54081

12pcs. Screw Bit Set with magnetic bit holder

Case set with more compact and cost-performance



Shank Type	Sales Pkg Qty	Part No.
C-form & E-form (NZ)	12x12set	D-31011

Double ended twist torsion screw bit



Size	Shank Type	Length (mm)	Sales Pkg Qty	Part No.	
+	PH 2	E-form (NZ)	90	3	A-59570
	PH 2		90	3	A-59601
	PH 2		65	3	A-67505
	PH 2 (Slim)		65	3	A-67511

Double ended silver torsion screw bit

Torsion section flexes under load and takes pressure off bit tip



Size	Shank Type	Length (mm)	Sales Pkg Qty	Part No.	
+	PH 2	E-form (MZ)	85	3	B-12326
	PH 2	E-form (NZ)	65	3	A-49563
	PH 2		65	6	A-49579
	PH 2		85	3	A-49585
	PH 2		110	3	A-49600
	PH 2		110	10	B-52037
	PH 2		150	3	A-50120

Drilling (Fastening)

Drill & drive bit

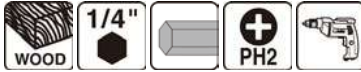

Shank Type	Bit Type	Length (mm)	Sales Pkg Qty	Part No.
1/4 inch hex shank	PH2	55	1	D-73209
				D-73215
				D-73221

Screw bit set (C-form)



Shank Type	Bit Type	Length (mm)	Flip top case 25pcs	Mini candy jar 100pcs
			Part No.	Part No.
C-form	PH 1	25	B-24577	-
	PH 2	25	B-24583	B-24876
	PH 2	25	-	-
	PH 3	25	B-24599	-

Screw bit for screwdriver (E-form)



Shank Type	Bit Type	Length (mm)	Flip top case 10pcs	Mini candy jar 50pcs	Plastic Bag 50pcs
			Part No.	Part No.	Part No.
E-form (NZ)	PH 1	50	B-25111	-	-
	PH 2	50	B-25127	B-25177	-
	PH 2	50	-	-	B-25199
	PH 3	50	B-25133	-	-

Impact deep socket for wheel nut Assortment



Shank Type	Socket Size mm	Length (mm)	Sales Pkg Qty	Part No.
1/2 Inch Drive	17, 19, 21	86	3	E-12354

Bit adapter



(Impact Wrench)

Shank Type	Bit Type	Length (mm)	Sales Pkg Qty	Part No.
3/8 Inch Drive	E-form (NZ)	57	1	B-68482
1/2 Inch Drive	E-form (NZ)	57	1	B-68476

Double ended screw bit set



Size	Shank Type	Length (mm)	10pcs
			Part No.
+	PH 2	E-form (NZ)	45
	PH 2		65
	PH 2		110
	PH 2		E-form (NZ) Slim

Battery type case



Part No.

B-69917

Magnetic nutsetter



** Magnetic Socket Bit



Shank Type	Socket Size (mm) / [inch]	Length (mm)	Sales Pkg Qty	Part No.
E-form (MZ)	8	65	1	784415-6
	10	65	1	784806-1
	3/8"	65	1	**784802-9
E-form (NZ)	8	50	1	**B-38934
	8	55	10	784403-3
	10	55	10	784405-9
	12	86	1	784407-5
	17	55	1	784416-4

Magnetic nutsetter set



Shank Type	Bit Type	Length (mm)	Sales Pkg Qty	Part No.
C-form	8,10,12,13	48	4	B-57554
NZ	6,8,10,12,13	50	5	B-39176

Drilling (Fastening)

Impact socket



Shank Type	Socket Size (mm)	Length (mm)	Sales Pkg Qty	Part No.
3/8 Inch Drive	6	28	1	B-39883
	7	28	1	B-39899
	8	28	1	B-39908
	9	28	1	B-39914
	10	28	1	B-39920
	11	28	1	B-39936
	12	28	1	B-39942
	13	28	1	B-39958
	14	28	1	B-39964
	15	28	1	B-39970
	16	28	1	B-39986
	17	30	1	B-39992
	18	30	1	B-40004
	19	30	1	B-40010
1/2 Inch Drive	20	30	1	B-40026
	21	30	1	B-40032
	22	30	1	B-40048
	14	38	1	B-40113
	17	38	1	B-40141
	19	38	1	B-40163

Impact deep socket (Bulk)



Shank Type	Socket Size (mm)	Length (mm)	Sales Pkg Qty	Part No.
1/2 Inch Drive	12	75	1	134867-5
	19	78	1	134837-4
	21	78	1	134839-0
	26	78	1	134843-9
	27	78	1	134845-5
	30	78	1	134847-1
	32	78	1	134849-7
3/4 Inch Drive	17	95	1	A-85503
	19	95	1	A-85525
	21	95	1	A-85547
	22	95	1	A-85569
	24	95	1	A-85581
	26	95	1	134854-4
	27	95	1	134856-0
	30	95	1	134858-6
	32	95	1	134859-4
	35	95	1	134861-7
	36	95	1	134863-3

Impact socket



Shank Type	Socket Size (mm)	Length (mm)	Impact Socket
			Part No.
1/2 Inch Drive	10	38	B-10497
	12	38	A-89931
	13	38	134825-1
	13	52	134827-7
	14	38	134826-9
	14	52	134828-5
	16	38	B-10506
	17	38	134829-3
	17	52	134830-8
	19	38	134831-6
	19	52	134832-4
	21	38	134838-2
	21	52	134833-2
	22	38	134851-0
	23	38	134840-5
	24	45	134841-3
	24	52	134836-6
	26	50	134842-1
	27	50	134844-7
	3/4 Inch Drive	32	50
17		50	A-85494
21		52	A-85531
22		52	A-85553
22		95	A-85569
24		52	A-85575
26		52	134853-6
27		52	134855-2
30		52	134857-8
32		52	134871-4
1 Inch Drive	35	56	134860-9
	36	56	134862-5
	35	80	134864-1
	36	80	134865-9
	41	80	134872-2

Impact socket set



(With pin and O ring)
A: 8, 10, 12, 13, 14, 17, 19, 21mm
B: 10, 11, 13, 17, 19, 21, 22, 24, 27 mm

Shank Type	Socket Size (mm)	Length (mm)	Sales Pkg Qty	Part No.
1/2 Inch Drive	A 8 to 21	38	8	E-02989
	B 10 to 27	38	9	B-69749

Roll Up Pouch

No Socket



Part No.

E-02995

O-ring / Pin for impact socket

Pin and O-ring, which are used for attaching socket to 1/2" SQ impact wrench (anvil), are packed with pouch pack respectively



Shank Type	Socket Size (mm)	Sales Pkg Qty	O Ring	Pin
			Part No.	Part No.
1/2 Inch Drive	8 to 21	3	-	B-54586
	17	3	B-54558	-

Drilling (Fastening)

Semi long socket bit



Shank Type	Socket Size (mm)	Length (mm)	Sales Pkg Qty	Part No.
E-form (NZ)	8	90	1	A-58914
	10	90	1	A-58920
	12	90	1	A-58936
	14	90	1	A-58958

Hollow socket bit



Shank Type	Socket Size (mm)	Length (mm)	Sales Pkg Qty	Part No.
E-form (MZ)	10	75	1	B-52526
	10	150	1	B-52532
	10	300	1	B-52548
	10	500	1	B-52554
	10	700	1	B-52560
	13	75	1	B-52576
	13	150	1	B-52582
	13	300	1	B-52598
	13	500	1	B-52607
	13	700	1	B-52613
	17	75	1	B-52629
	17	150	1	B-52635
	17	300	1	B-52641
	17	500	1	B-52657
	17	700	1	B-52663

Bit Catcher



Part No.

B-63105

Threaded rod socket bit



Shank Type	Socket Size	Length (mm)	Sales Pkg Qty	Part No.
E-form (MZ)	M6	66	1	B-42961
	M8	66	1	B-42977
	M10	66	1	B-42983
	3/8"	66	1	B-51611
	1/2"	66	1	B-51627

Socket extension



Shank Type	Bit Type	Length (mm)	Sales Pkg Qty	Part No.
1/2 Inch Drive	1/2 Inch Drive	75	1	B-55728
		150	1	B-55712
		250	1	B-55706



ACCESSORIES

▣ Drill and Screw Bit Sets



Drill and Screw Bit Sets



MAKPAC 65pcs. Set for SDS-PLUS

In the set:

HSS-TiN drill bit for SDS-PLUS x8pcs.
 Wood drill bit for SDS-PLUS x5pcs, Masonry drill bit for SDS-PLUS x5pcs,
 Screw bit 25mm x40pcs. ,Nutsetter x4pcs.
 Countersink, Sleevechuck bitholder for SDS-PLUS, Tape Measure 3m



Metric Size

Part No.

B-69478

104pcs. Combination set

In the set:

HSS-TiN drill bit x14pcs.
 Masonry drill bit x5pcs.
 Brad point drill bit x7pcs.
 Flat bits x3pcs.
 Countersink, Depth guage x4pcs.
 Hex. wrench 2.5 for depth gauge, Screw bit 25mm x40pcs.
 Magnetic bit holder, Sleeve chuck bit holder, Screw bit 50mm x18pcs,
 Nutsetter x4pcs.
 Leveler, Measure 3m, Diameter gauge, Cutter knife with 7 spare blades
 (1set), Screw driver for C form (hand tool)



Metric Size

Part No.

D-37150

Drill and Screw Bit Sets

50pcs. Bit & Hand tool display set (6pcs. set)

In the set:

Masonry drill bit x6pcs.
 Wood drill bit x5pcs, Flat bit x2pcs.
 HSS-R drill bit x11pcs.
 Diameter gauge 1-10mm, Countersink bit, Knife, Screw bit 25mm x18pcs.
 Magnetic bit holder, Socket x3pcs.
 Socket adapter



Metric Size
Part No.
D-53687

103pcs. Bit & Hand tool display set

In the set:

Masonry drill x7pcs.
 Wood drill x7pcs.
 Flat bit x3pcs.
 HSS-R drill bit x11pcs, Hole saw, Hole saw arbor, Depth stop, Tape Measure 3m, Diameter gauge 1-10mm,
 Hex key wrench, Level, Countersink,
 Screw bit 25mm x24pcs, Magnetic bit holder,
 Socket x7pcs.
 Socket adapter for 25mm screw driver, Long nose plier,
 Combination plier, Adjustable wrench,
 Nail hammer metric



Metric Size
Part No.
D-42341

Drill bit assortment with 1/4" Hex. shank(NZ)

Sales pkg qty: 5



Diameter(mm)			Metric Size
Masonry	Metal	Wood	Part No.
-	5, 6, 8mm	5, 6mm	D-31516
6mm	5, 6mm	5, 6mm	D-31522

HSS metal drill 5pc. drill bit assortment

Sales pkg qty: 5



Diameter(mm)			Metric Size
Masonry	Metal	Wood	Part No.
-	5, 6, 8mm	6, 8mm	D-30106

Wood Brad Point Drill Bit Set

Sales pkg qty: 8

In the set:

3, 4, 5, 6, 7, 8, 9 10mm
 drill bits



Metric Size
Part No.
D-77257

Drill bit 9pc. assortment

Sales pkg qty: 9



Diameter(mm)			Metric Size
Masonry	Metal	Wood	Part No.
5, 6, 8mm	5, 6, 8mm	5, 6, 8mm	D-71962

Drill & Screw bit Set 17pc. assortment

Sales pkg qty: 17

In the set:

Drill Bits:
 Masonry drill: 5, 6, 8mm
 Wood drill: 5, 6, 8mm
 Metal drill: 5, 6, 8mm
 Screw Bits:
 PH1, PH2, PH3, PZ2, H4, H5, SL5
 & Sleeve Chuck Bit Holder.



Metric Size
Part No.
D-77207

ACCESSORIES

▣ Cutting



Wood



Plaster board



Epoxy



Plastic



Fiberglass



TC grit 30-40



TC grit 40-50











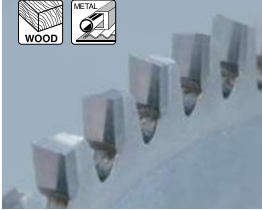

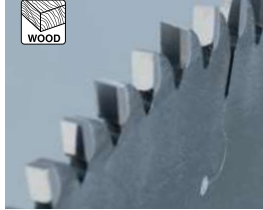

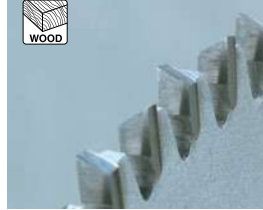



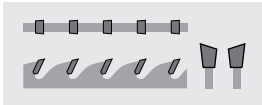
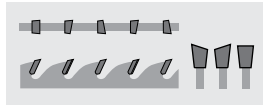
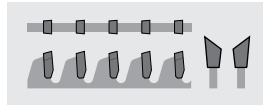
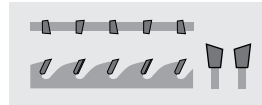
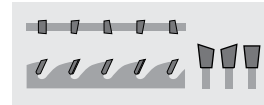

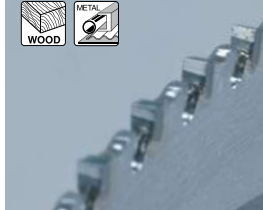

Low noise

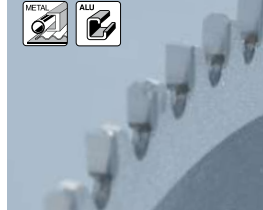

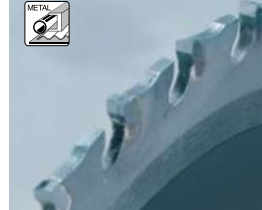
Cutting

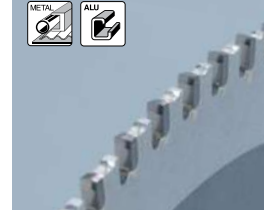
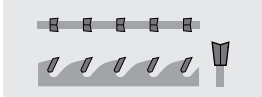
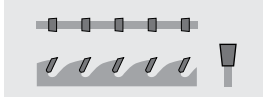
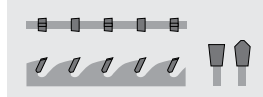
T.C.T Saw Blade

Tooth shape

<p>ATB</p>  	<p>ATBR</p>  	<p>Hi-ATB</p>  	<p>ATAF</p>  	<p>ATAFR</p>  
<p>Alternate top bevel For wood and aluminum.</p>	<p>Added flat teeth to ATB for easy straight cutting</p>	<p>Alternate top bevel (ATB) with a larger top bevel angle</p>	<p>Alternate top alternate face Enables to cut wood fiber sharply.</p>	<p>Added flat teeth to ATAF for easy straight cutting. MATAFR: Modified ATAFR for less cutting resistance.</p>
				
<p>M-FORCE</p>  	<p>FTG</p>  	<p>TCG</p>  	<p>MTCG</p>  	<p>SMTCG</p>  
<p>Tooth front and top shapes symmetric V groove having features of ATB and FTG.</p>	<p>Flat teeth, allows easy straight cutting and tips are rarely chipped. For cutting wood along the grain and cutting thin metal.</p>	<p>Trapezoidal and flat teeth are arranged alternatively and they divide debris by three. Allows easy straight cutting and tips are rarely chipped.</p>	<p>Flat teeth with alternating bevel Less cutting resistance than flat teeth. Tips are rarely chipped</p>	<p>Contrast to MTCG, asymmet- ric two bevels on a tooth top producing sharp edges Allows easy bite to materials.</p>
				

Technical term

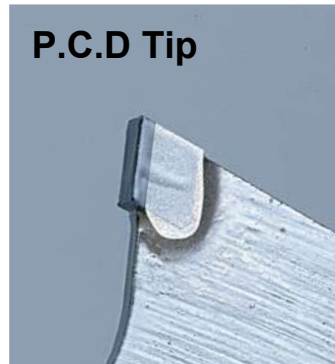
<p>Laser Slit</p> 	<p>Coated</p> 	<p>Tip Embedded</p> 	<p>P.C.D Tip</p> 
<p>Vibration dampening system Resinbond filled laser cut body slots for smoother and quieter cuts.</p>	<p>PTFE (polytetrafluoroethylene) coating plate to reduce pitch build-up and to lower resistance.</p>	<p>Inserted tooth design will greatly increase the body-to-tip braze area for greater support and tip strength.</p>	<p>PCD (Poly-Crystalline Diamond) tips has extreme hardness and wear resistance. PCD tipped saw blade is the best choice for long lasting performance when cutting fiber cement board.</p>



Feature



Sharp top angle



Enable you to make a fine cut surface with only little effort.



Curved body



Allows the excellent chip chute performance.



Slimmed bottom



Realizes long life battery by saving cutting resistance.

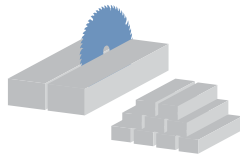

More cuts per charge



Fast cutting



Longer life

The amount of cutting per 1 charge

Plate: 1.6mm



165mm x 48T

Plate: 1.0mm



165mm x 50T

EFFICUT

100

× 2.4
more

240

The test results depend to a great extent on the hardness of wood materials, etc.



VIDEO CLIP

This movie was filmed in Japan.

Models and specs may vary by country.



for Wood

Ideal for Cordless Circular Saw



Outer dia (mm)	Range	Material	No. of teeth	Kerf (mm)	Plate (mm)	Rake	Tooth shape	Bore (mm)	Ring (mm)	Note	Per pkg	Part No.
165	★★★	Wood	24	1.6	1.0	20	ATAFR	20	-	-	1	E-15665
	★★★★★	Wood	25	1.4	1.0	23	ATAFR	20	-	-	1	B-63018
		Wood/MDF	56	1.45	1.0	23	ATAFR	20	-	-	1	B-57364
		Wood	60	1.45	1.0	23	ATAFR	20	-	-	1	B-69892
185	★★★	Wood	24	1.6	1.0	23	ATAFR	20	-	-	1	E-15671
	★★★★★	Wood	24	1.45	1.0	23	ATAFR	20	-	-	1	B-62022
		Wood	45	1.45	1.0	23	ATAFR	20	-	-	1	B-68616
190	★★★★★	Wood	24	1.45	1.0	23	ATAFR	20	-	-	1	B-64200
		Wood	45	1.45	1.0	23	ATAFR	20	-	-	1	B-68644
235	★★★★★	Wood	24	2.2	1.5	20	ATBR	25	-	-	1	E-01959

Ideal for Cordless Plunge Saw



Outer dia (mm)	Range	Material	No. of teeth	Kerf (mm)	Plate (mm)	Rake	Tooth shape	Bore (mm)	Ring (mm)	Note	Per pkg	Part No.
165	★★★★★	Wood/MDF	56	1.45	1.0	23	ATAFR	20	-	for Plunge Cut Circular Saw	1	B-57364

Cutting

Ideal for Cordless Metal Cutter



Outer dia (mm)	Range	Material	No. of teeth	Kerf (mm)	Plate (mm)	Rake	Tooth shape	Bore (mm)	Ring (mm)	Note	Per pkg	Part No.
150	★★★★★	Wood	25	1.4	1.0	23	ATAFR	20	-	for Metal Cutter	1	E-06937

Ideal for Cordless Slide Compound Saw



Outer dia (mm)	Range	Material	No. of teeth	Kerf (mm)	Plate (mm)	Rake	Tooth shape	Bore (mm)	Ring (mm)	Note	Per pkg	Part No.
165	★★★★★	Wood	60	1.85	1.4	10	ATBR	20	-	-	1	B-69892
216	★★★★★	Wood	45	2	1.5	10	ATBR	25.4	-	-	1	E-07010
260	★★★★★	Wood	45	2.15	1.7	10	ATBR	25.4	-	-	1	B-64668
		Wood	60	2.15	1.7	10	ATBR	25.4	-	-	1	B-67430
		Wood	80	2.15	1.7	10	ATBR	25.4	-	-	1	B-67446
305	★★★★★	Wood	60	2.15	1.7	10	ATBR	25.4	-	-	1	B-67452
		Wood	80	2.15	1.7	10	ATBR	25.4	-	-	1	B-67468
		Wood	100	2.15	1.7	10	ATBR	25.4	-	-	1	B-67474



Feature

Curved body



Allows the excellent chip chute performance.

Slimmed bottom



Realizes long life battery by saving cutting resistance.

The amount of cutting per 1 charge

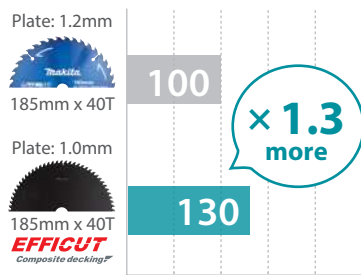

Following the tooth design of Efficut for wood with

- Tip hardness was improved
- Having obtuse tip angle then realized longer life and more cuts per charge.

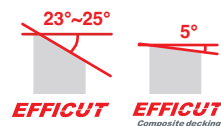

Life

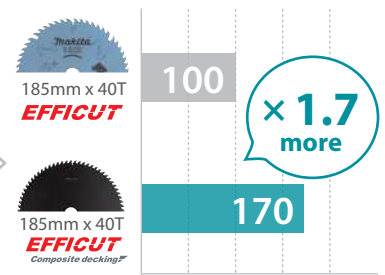

★★★★★

for Composite deck

Ideal for Cordless Circular Saw



Outer dia (mm)	Range	Material	No. of teeth	Kerf (mm)	Plate (mm)	Rake	Tooth shape	Bore (mm)	Ring (mm)	Note	Per pkg	Part No.
185	★★★★★	Composite	40	1.50	1.00	15	ATAFR	20	-	-	1	E-11972
260	★★★★★	Composite	75	2.15	1.65	8	ATAFR	25.4	-	-	1	E-11988

Feature

Strong and least chipping

Special blade tip design greatly improves efficiency and durability.

Release swarf smoothly

Superior in straight cutting

The load on blade tips can be distributed efficiently to suppress wobbling of saw blade, providing steady straight cutting and increased durability against tip breakage.

More cuts per charge

Fast cutting

Longer life

The amount of cutting per 1 charge

Plate: 1.2mm



Plate: 0.95mm

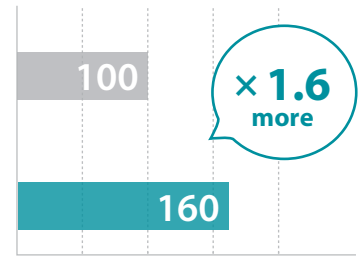

Model: DCS553 (BL1860B)
Material: Carbon steel pipe (Dia: 31mm / Thickness: 3mm)



This movie was filmed in Japan.
Models and specs may vary by country.

★★★★★

for Metal

Ideal for Cordless Metal Cutter

Outer dia (mm)	Range	Material	No. of teeth	Kerf (mm)	Plate (mm)	Rake	Tooth shape	Bore (mm)	Ring (mm)	Note	Per pkg	Part No.
136	★★★★★	Metal	30	1.1	1.0	0	SMTCCG	20	-	-	1	B-69428
		Metal & SUS	45	1.1	1.0	0	SMTCCG	20	-	-	1	B-69434
150	★★★★★	Metal	33	1.1	1.0	0	SMTCCG	20	-	-	1	B-69440
		Metal & SUS	48	1.1	1.0	0	SMTCCG	20	-	-	1	B-69456
185	★★★★★	Metal	45	1.4	1.2	0	SMTCCG	20	-	-	1	E-12918
		Metal & SUS	60	1.4	1.2	0	SMTCCG	20	-	-	1	E-12924

Ideal for Cordless Metal Cutting Saw



Outer dia (mm)	Range	Material	No. of teeth	Kerf (mm)	Plate (mm)	Rake	Tooth shape	Bore (mm)	Ring (mm)	Note	Per pkg	Part No.
305	★★★★★	Metal	63	2.0	1.75	-2	SMTCCG	25.4	-	-	1	E-12083

EFFICUT Aluminum

Feature

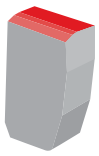

Strong and least chipping



Special blade tip design greatly improves efficiency and durability.

Superior in straight cutting

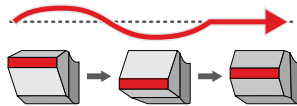

The load on blade tips can be distributed efficiently to suppress wobbling of saw blade, providing steady straight cutting and increased durability against tip breakage.



Reduce cutting resistance



Realizes high durability and reduce cut resistance.

Allows the excellent chip ejection.



Realizes long life battery by saving cutting resistance.

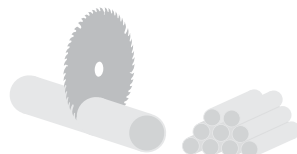

More cuts per charge



Fast cutting



Longer life

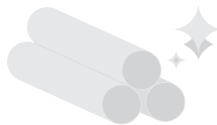

Clean cutting

The amount of cutting per 1 charge

Plate: 1.6mm



260mm x 80T

Plate: 1.0mm



260mm x 81T

EFFICUT
Aluminum

100

× 1.4
more

140

Model: DLS110(BL1860B x2)

Material : Aluminum frame (WxH=45x45mm, t=2mm)



VIDEO CLIP

This movie was filmed in Japan.
Models and specs may vary by country.

★★★★★

for Aluminum

Ideal for Cordless Slide Compound Saw



Outer dia (mm)	Range	Material	No. of teeth	Kerf (mm)	Plate (mm)	Rake	Tooth shape	Bore (mm)	Ring (mm)	Note	Per pkg	Part No.
260	★★★★★	Aluminum	81	1.85	1.5	-3	SMTCG	25.4	-	-	1	E-06345

Cutting

For Wood

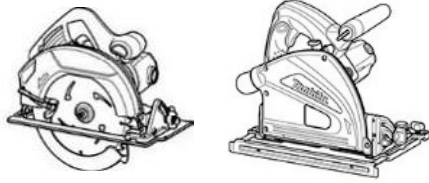

(Circular Saw) & (Plunge Cut Circular Saw)



Outer dia (mm)	Range	Material	No. of teeth	Kerf (mm)	Plate (mm)	Rake	Tooth shape	Bore (mm)	Ring (mm)	Note	Per pkg	Part No.
85	★★★	Wood	20	1.00	0.70	10	ATB	15	-	for Cordless Saw	1	B-14607
		Wood	50	0.50	0.50	-	-	15	-	for Cordless Saw	1	792259-0
		Plastics	50	0.50	0.50	-	-	15	-	for Cordless Saw	1	792299-8
110	★★★	Wood	30	1.60	1.00	10	ATAF	20	-	-	1	B-16950
	★★	Wood	24	1.70	1.10	10	ATB	20	-	-	1	D-15578
		Wood	30	1.60	1.00	10	SMTCG	20	-	-	1	B-39475
136	★★★	Wood	16	1.50	1.00	20	ATAF	20	-	for Cordless Saw	1	B-09949
	★★★	Wood/MDF	40	1.50	1.00	20	ATAF	20	-	for Cordless Saw	1	D-59156
160	★★★	Wood	24	2.20	1.40	25	ATAF	20	-	-	1	A-81371
		Wood	40	1.60	1.00	18	ATB	20	-	-	1	A-80612
		Wood	40	1.80	1.20	20	ATAF	20	-	Economy	1	B-16994
		Wood	40	2.20	1.40	20	ATAF	20	-	-	1	A-81898
165	★★★★★	Wood	25	1.40	1.00	23	ATAFR	20	-	EFFICUT	1	B-63018
	★★★	Wood	10	2.00	1.40	20	FTG	20	-	-	1	B-02917
		Wood	28	2.20	1.60	15	ATB	20	-	for Plunge Cut Circular Saw	1	B-07434
		Wood	40	1.60	1.00	18	ATAF	20	-	for Cordless Saw	1	A-85226
		Wood	40	2.00	1.20	20	-	20	-	-	1	P-67929
		Wood	44	1.45	1.00	23	ATAFR	20	-	-	1	B-53285
		Wood	48	1.85	1.25	8	ATB	20	-	Fast cut for Plunge Cut Circular Saw	1	B-56166
		Wood	64	1.90	1.40	10	ATAF	20	-	-	1	B-56487
		Wood/NAIL	16	2.00	1.25	23	ATB	20	-	-	1	A-86022
		Wood/NAIL	24	2.00	1.25	23	ATB	20	-	-	1	A-86038
Wood/NAIL	40	2.00	1.25	18	ATB	20	-	-	1	A-86044		

Cutting

Outer dia (mm)	Range	Material	No. of teeth	Kerf (mm)	Plate (mm)	Rake	Tooth shape	Bore (mm)	Ring (mm)	Note	Per pkg	Part No.
165	★★	Wood	40	2.00	1.30	18	ATB	20	-	-	1	D-03349
	★	Wood	40	2.00	1.20	12	ATB	20	-	-	1	D-50500
180	★★★	Wood	24	2.20	1.40	25	ATAF	20	-	-	1	A-81402
		Wood	40	2.20	1.40	20	ATAF	20	-	-	1	A-81418
185	★★★★★	Wood	45	1.45	1.00	23	ATAFR	20	-	EFFICUT	1	B-68616
	★★★	Wood	40	1.60	1.00	18	ATAF	20	-	-	1	A-82476
		Wood	60	1.60	1.00	18	ATAF	20	-	-	1	A-82482
		Wood/NAIL	40	2.00	1.25	25	ATB	30	20	-	1	A-86072
	★★	Wood	16	2.00	1.30	20	ATB	30	20/16	-	1	D-03903
		Wood	20	2.00	1.30	20	ATB	30	20/16	-	1	D-09634
		Wood	24	1.80	1.20	20	ATB	20	-	-	1	D-19037
		Wood	40	2.00	1.30	18	ATB	20	-	-	1	D-03361
Wood		40	2.00	1.30	18	ATB	30	20/16	-	1	D-03919	
★		Wood	24	2.20	1.40	15	ATB	25.4	20	-	1	D-50522
190	★★★★★	Wood	40	2.20	1.40	14	ATB	25.4	20	-	1	D-50538
		Wood	24	1.45	1.00	23	ATAFR	20	-	EFFICUT	1	B-64200
210	★★★★★	Wood	45	1.45	1.00	23	ATAFR	20	-	EFFICUT	1	B-68644
		Wood	24	2.00	1.30	20	ATB	25	-	-	1	D-29066
235	★★★★★	Wood	24	2.20	1.50	20	ATBR	25	-	EFFICUT	1	E-01959
	★★★	Wood	20	2.30	1.60	20	ATB	25	-	-	1	A-89947
		Wood	60	2.60	1.80	20	ATAF	25.4	25	-	1	A-81474
	★★	Wood	20	2.40	1.60	20	ATB	30	25.4/25	-	1	D-03925
		Wood	40	2.40	1.60	18	ATB	25.4	25	-	1	D-03377
		Wood	60	2.40	1.60	15	ATB	30	25	-	1	D-09640
★	Wood	40	2.50	1.60	12	ATB	25.4	25	-	1	D-50550	
260	★★★	Wood	24	2.30	1.60	20	ATB	25.4	-	-	1	B-10584
	★	Wood	40	2.60	1.80	15	ATB	30	-	EAC mark only	1	D-65377
335	★★★	Wood	60	3.00	2.20	20	ATB	25	-	-	1	B-12603
355	★★★	Wood	20	3.00	2.20	27	ATAF	30	-	-	1	A-80014
		Wood	60	3.00	2.20	18	ATB	30	-	-	1	A-81854



Cutting

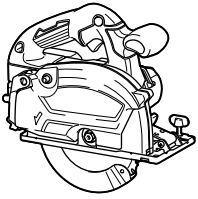

(Cordless Metal Cutter)

Outer dia (mm)	Range	Material	No. of teeth	Kerf (mm)	Plate (mm)	Rake	Tooth shape	Bore (mm)	Ring (mm)	Note	Per pkg	Part No.
150	★★★★★	Wood	25	1.40	1.00	23	ATAFR	20	-	EFFICUT	1	E-06937

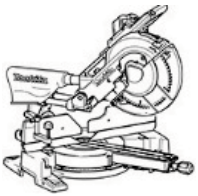

(Slide Compound Saw / Miter Saw)

Outer dia (mm)	Range	Material	No. of teeth	Kerf (mm)	Plate (mm)	Rake	Tooth shape	Bore (mm)	Ring (mm)	Note	Per pkg	Part No.
165	★★★★★	Wood	60	1.85	1.35	10	ATBR	20	-	EFFICUT	1	B-69892
	★★★	Wood	64	1.90	1.40	10	ATAF	20	-	-	1	B-56487
190	★★★	Wood	24	2.00	1.40	-5	ATB	20	-	-	1	B-03866
		Wood	40	2.00	1.40	10	ATAF	20	-	-	1	A-86751
		Wood	72	2.00	1.40	10	ATAF	20	-	-	1	A-86359
210	★★★	Wood	18	1.90	1.40	25	ATB	30	25	-	1	A-81767
216	★★★★★	Wood	45	2.00	1.50	10	ATBR	25.4	-	EFFICUT	1	E-07010
	★	Wood	80	2.20	1.40	16	ATAF	25.4	-	-		D-75057
255	★★★	Wood	32	2.30	1.80	5	ATAF	25.4	-	EFFICUT	1	A-83696
		Wood	40	2.20	1.70	10	ATAF	25.4	-	-	1	B-10322
		Wood	80	2.30	1.80	5	ATB	25.4	-	-	1	B-03648
260	★★★★★	Wood	45	2.15	1.65	10	ATBR	25.4	-	EFFICUT	1	B-64668
		Wood	60	2.15	1.65	10	ATBR	25.4	-	EFFICUT	1	B-67430
		Wood	80	2.15	1.65	10	ATBR	25.4	-	EFFICUT	1	B-67446
	★★★	Wood	60	2.3	1.80	5	ATAF	30	15.88	-	1	B-11019
		Wood	64	2.30	1.80	5	ATAF	25	-	-	1	792695-0
	★	Wood	40	2.60	1.80	15	ATB	25.4	-	-	1	D-65414
305	★★★★★	Wood	100	2.60	1.80	12	ATB	25.4	-	-	1	D-65442
		Wood	60	2.15	1.65	10	ATBR	25.4	-	EFFICUT	1	B-67452
		Wood	80	2.15	1.65	10	ATBR	25.4	-	EFFICUT	1	B-67468
	★★★	Wood	100	2.15	1.65	10	ATBR	25.4	-	EFFICUT	1	B-67474
		Wood	40	2.30	1.80	5	ATB	30	-	BlueMak	1	B-54237
		Wood	60	2.30	1.80	5	ATAF	25.4	-	-	1	B-02808
		Wood	70	2.50	1.90	0	ATAF	25.4	-	-	1	B-57560
		Wood	96	2.30	1.80	5	ATAF	25.4	-	-	1	B-02814
		Wood	100	2.30	1.80	5	ATB	25.4	-	-	1	B-03698
	★	Wood	60	2.80	2.00	15	ATB	25.4	-	-	1	D-72366
		Wood	80	2.80	2.00	15	ATB	25.4	-	-	1	D-72372
		Wood	100	2.80	2.00	15	ATB	25.4	-	-	1	D-72388
355	★★★	Wood	60	2.60	2.00	10	ATB	25.4	-	-	1	A-85488

Cutting



(Table Saw)

Outer dia (mm)	Range	Material	No. of teeth	Kerf (mm)	Plate (mm)	Rake	Tooth shape	Bore (mm)	Ring (mm)	Note	Per pkg	Part No.
203	★★★	Wood	24	2.00	1.40	25	ATAF	25.4	25	Economy	1	B-17099
		Wood	40	2.00	1.40	20	ATAF	25.4	25	Economy	1	B-17120
		Wood	40	2.40	1.60	20	ATAF	25.4	25	-	1	A-81430
		Wood	60	2.00	1.40	15	ATAF	25.4	25	Economy	1	B-17142
		Wood	80	2.00	1.40	15	ATAF	25.4	25	Economy	1	B-17158
255	★★★	Wood	24	2.30	1.60	20	ATB	25.4	-	-	1	B-05000
		Wood	40	2.30	1.60	20	ATB	25.4	-	-	1	B-05088
		Wood	40	2.40	1.80	20	ATAF	25.4	25	-	1	A-82529
		Wood	60	2.80	2.00	20	ATAF	25.4	25	-	1	A-81505
		Wood	80	2.40	1.80	15	ATAF	25.4	25	Economy	1	B-17295
		Wood	100	2.60	2.00	15	ATAF	25.4	25	-	1	A-82292
305	★★★	Wood	60	3.00	2.00	20	ATAF	25.4	25	-	1	A-82105
		Wood	100	3.00	2.20	15	ATAF	25.4	25	-	1	A-82323
355	★★★	Wood	80	3.00	2.20	20	ATAF	25.4	25	Economy	1	B-17463
		Wood	80	3.40	2.40	20	ATAF	25.4	25	-	1	A-81533
		Wood	100	3.40	2.40	15	ATAF	25.4	25	-	1	A-82351
405	★★★	Wood	80	3.60	2.60	20	ATAF	25.4	25	-	1	A-81561

For MDF



(Circular Saw) & (Plunge Cut Circular Saw)

Outer dia (mm)	Range	Material	No. of teeth	Kerf (mm)	Plate (mm)	Rake	Tooth shape	Bore (mm)	Ring (mm)	Note	Per pkg	Part No.
165	★★★★★	Wood/MDF/Laminate	56	1.45	1.00	23	ATAFR	20	-	EFFICUT	1	B-57364
	★★★★	Wood/MDF/Laminate	44	1.45	1.00	23	ATAFR	20	-	Coated / Laser Slit Specialized for cordless saws	1	B-53279
	★	MDF/Laminate	52	2.20	1.40	-5	TCG	20	15.88	-	1	D-62474
185	★★	MDF	60	2.40	1.50	12	TCG	30	20/16	-	1	D-17902



(Slide Compound Saw / Miter Saw)

Outer dia (mm)	Range	Material	No. of teeth	Kerf (mm)	Plate (mm)	Rake	Tooth shape	Bore (mm)	Ring (mm)	Note	Per pkg	Part No.
255	★★	MDF/Laminate	100	3.20	2.40	10	TCG	30	15.88	-	1	D-19071
	★	MDF/Laminate	84	2.80	1.80	10	TCG	25.4	-	-	1	D-62480
		MDF/Laminate	100	2.80	1.80	10	TCG	25.4	15.88	-	1	D-72279
305	★★	MDF/Laminate	120	3.20	2.40	10	TCG	30	15.88	-	1	D-19087
	★	MDF/Laminate	96	3.00	2.00	10	TCG	25.4	-	-	1	D-62496

Cutting

For Metal

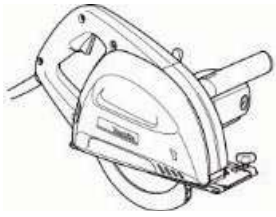

(Metal Cutter)



Outer dia (mm)	Range	Material	No. of teeth	Kerf (mm)	Plate (mm)	Rake	Tooth shape	Bore (mm)	Ring (mm)	Note	Per pkg	Part No.
136	★★★★★	Metal	30	1.10	0.95	0	SMTCG	20	-	EFFICUT Metal	1	B-69428
		Metal/SUS	45	1.10	0.95	0	SMTCG	20	-	EFFICUT Metal	1	B-69434
	★★★	Metal	30	1.50	1.20	0	MTCG	20	-	-	1	B-07319
		Metal/SUS	56	1.10	0.95	0	FTG	20	-	Laser Slit	1	B-23117
150	★★★★★	Metal	33	1.10	0.95	0	SMTCG	20	-	EFFICUT Metal	1	B-69440
		Metal/SUS	48	1.10	0.95	0	SMTCG	20	-	EFFICUT Metal	1	B-69456
	★★★	Thin sheet metal	52	1.40	1.10	-15	ATB	20	-	-	1	B-47008
		Metal	32	1.50	1.20	0	MTCG	20	-	-	1	B-46296
		Thick metal	32	1.10	0.95	0	TCG	20	-	Laser Slit	1	B-68301
		Metal/SUS	60	1.10	1.00	0	SMTCG	20	-	Laser Slit	1	B-47014
185	★★★	Thin metal	48	1.85	1.50	0	SMTCG	20	-	Long Life	1	B-23357
		Metal	36	1.90	1.50	0	ATB	20	-	-	1	B-04628
		Metal	38	2.00	1.60	0	MTCG	20	-	-	1	A-85438
		Metal	48	2.00	1.60	0	MTCG	20	-	-	1	A-83967
		Metal	56	1.80	1.50	0	SMTCG	20	-	Long Life	1	B-23391
		Metal	70	1.70	1.30	-10	FTG	20	-	-	1	A-86446
		Metal/SUS	64	1.60	1.30	0	FTG	20	-	Long Life	1	B-31697



(Metal Cutting Saw)

Outer dia (mm)	Range	Material	No. of teeth	Kerf (mm)	Plate (mm)	Rake	Tooth shape	Bore (mm)	Ring (mm)	Note	Per pkg	Part No.
305	★★★	Metal	60	2.10	1.70	0	TCG	25.4	-	Economy	1	A-87242
		Metal	60	2.40	2.00	0	TCG	25.4	-	Laser Slit	1	A-86723
		Metal	60	2.50	2.20	0	TCG	25.4	-	-	1	A-81860
		Metal	78	2.30	2.00	0	MTCG	25.4	-	Laser Slit	1	A-87127
	★★★★★	Metal/SUS	96	2	1.75	-3	SMTCG	25.4	-	EFFICUT Metal	1	E-19788
	★★★	Metal/SUS	100	1.95	1.65	-3	SMTCG	25.4	-	-	1	B-23151
	★★	Metal	60	2.40	2.00	0	TCG	25.4	-	-	1	D-71364

Cutting

for Aluminum



(Circular Saw) & (Plunge Cut Circular Saw) & (Metal Cutter)



Outer dia (mm)	Range	Material	No. of teeth	Kerf (mm)	Plate (mm)	Rake	Tooth shape	Bore (mm)	Ring (mm)	Note	Per pkg	Part No.
136	★★★	Aluminum	50	1.60	1.00	0	ATB	20	-	-	1	B-40331
150	★★★	Aluminum	52	1.60	1.00	0	ATB	20	-	-	1	B-47020
165	★★★★	Aluminum	56	2.00	1.40	-3	TCG	20	-	for Plunge Cut Circular Saw	1	B-56655
	★★★	Aluminum	56	2.40	1.70	-3	TCG	20	-	for Plunge Cut Circular Saw	1	B-07440

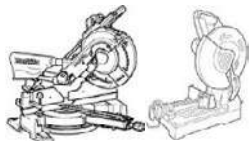

(Slide Compound Saw / Miter Saw) & (Metal Cutting Saw)

Outer dia (mm)	Range	Material	No. of teeth	Kerf (mm)	Plate (mm)	Rake	Tooth shape	Bore (mm)	Ring (mm)	Note	Per pkg	Part No.
165	★★★	Aluminum	60	1.80	1.20	5	TCG	20	-	Laser Slit	1	B-56530
185	★★★★★	Aluminum	60	1.7	1.35	0	SMTCG	20	-	EFFICUT Aluminum	1	E-16841
190	★★★	Aluminum	60	2.00	1.40	-5	TCG	20	-	-	1	B-03997
216	★★★★★	Aluminum	63	1.7	1.50	0	SMTCG	25.4	-	-	1	E-16944
190	★★★	Aluminum	60	2.00	1.40	-5	TCG	20	-	-	1	A-86767
255	★★★	Aluminum	100	2.60	2.00	0	ATB	25.4	25	Clean cut	1	A-81614
255	★★★	Aluminum	120	3.00	2.10	0	TCG	25.4	-	-	1	P-68018
260	★★★★★	Aluminum	81	1.85	1.50	-3	SMTCG	25.4	-	EFFICUT Aluminum	1	E-06345
	★★	Aluminum	100	3.00	2.00	5	TCG	25.4	-	-	1	D-03414
	★	Aluminum	100	2.60	1.80	5	TCG	25.4	-	-	1	D-59162
	★	Aluminum	70	3.00	2.00	5	TCG	25.4	-	-	1	D-73075
305	★★★★★	Aluminum	81	2.00	1.65	-3	SMTCG	25.4	-	EFFICUT Aluminum EFFICUT Aluminum	1	E-13281 E-13340
	★★	Aluminum	96	2.00	1.65	-3	SMTCG	25.4	-	-	1	D-16520
	★★	Aluminum	80	3.00	2.20	5	TCG	30	15.88	-	1	D-16520
	★	Aluminum	80	3.00	2.20	5	TCG	25.4	-	-	1	D-73081
	★	Aluminum	100	3.00	2.20	5	TCG	25.4	-	-	1	D-73097
355	★★★	Aluminum	80	3.00	2.20	5	TCG	25	-	-	1	A-02602
	★★	Aluminum	120	3.30	2.35	8	TCG	30	25	-	1	D-16592

For Multi-purpose

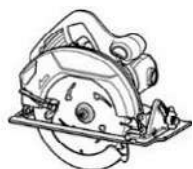

(Circular Saw)



Outer dia (mm)	Range	Material	No. of teeth	Kerf (mm)	Plate (mm)	Rake	Tooth shape	Bore (mm)	Ring (mm)	Note	Per pkg	Part No.
165	★	Wood,MDF,Aluminum,PVC	60	2.20	1.40	5	TCG	30	20/19/16/15.88	-	1	D-63616
185	★	Wood,MDF,Aluminum,PVC	60	2.20	1.40	5	TCG	30	20/16/15.88	-	1	D-63622
235	★	Wood,MDF,Aluminum,PVC	60	2.40	1.60	5	TCG	30	25.4/25/20/16	-	1	D-63557

Cutting



(Slide Compound Saw / Miter Saw)

Outer dia (mm)	Range	Material	No. of teeth	Kerf (mm)	Plate (mm)	Rake	Tooth shape	Bore (mm)	Ring (mm)	Note	Per pkg	Part No.
260	★	Wood,MDF,Aluminum,PVC	120	2.60	1.80	5	TCG	30	25.4/25/20/16	-	1	D-62240
305	★	Wood,MDF,Aluminum,PVC	120	2.80	2.00	5	TCG	30	25.4/25/20/16	-	1	D-63591
355	★	Wood,MDF,Aluminum,PVC	100	3.00	2.20	5	TCG	30	25.4/25/20/16	-	1	D-63884

For Others

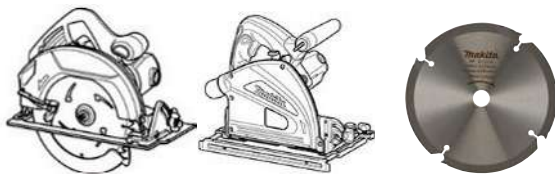

(Circular Saw) & (Plunge Cut Circular Saw)

Outer dia (mm)	Range	Material	No. of teeth	Kerf (mm)	Plate (mm)	Rake	Tooth shape	Bore (mm)	Ring (mm)	Note	Per pkg	Part No.
165	★★★	Sandwichpanel	42	1.75	1.40	0	SMTCG	20	-	-	1	B-63161
	★★	Fiber Cement Board	4	1.80	1.40	12	FTG	20	15.88	-	1	D-72104
185	★★	Fiber Cement Board	4	1.80	1.40	12	FTG	20	15.88	-	1	D-72110

Ring Size for Miter Saw



(D) Hole Dia (mm)	(H) Outer Dia (mm)	Part No.
16	30	257262-3
15.88	25.4	257060-5

Specialized for Aluminum Groove Cutter (CA5000)

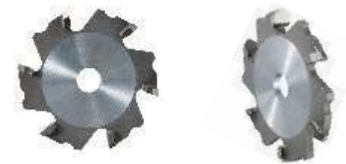

Outer dia (mm)	Range	Material	No. of teeth	Kerf (mm)	Plate (mm)	Rake	Tooth shape	Bore (mm)	Ring (mm)	Note	Per pkg	Part No.
118	Specialized	Aluminum composite panel	6	14.00	6.00	5	TCG	20	-	Grooving 90° for Aluminum Groove Cutter	1	B-48832
		Aluminum composite panel	6	18.00	6.00	5	TCG	20	-	-Grooving 135° for Aluminum Groove Cutter	1	B-48860

ACCESSORIES

▣ Jigsaw / Reciprosawing



Metal, mild steel



Stainless steel



Aluminum



Wood



Wood with nails



Cork



Chipboard



Laminate board



Leather



Cardboard



Soft brick



Fiber cement board



Aerated concrete



Cast iron



Rubber



Ice



Plaster board



Plastic



Fiberglass



Raker



Wave



Wave cut knife



Japanese teeth



Sharp edge



Makita Shank jig Saw Blade



Bayonet Shank jig Saw Blade

Jigsaw / Reciprosawing

Jig Saw blade

Teeth Type

Milled and side set teeth

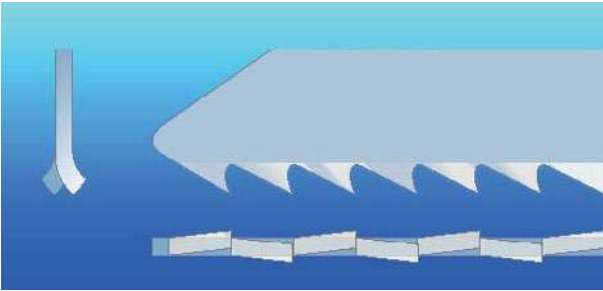

Ground and side set teeth

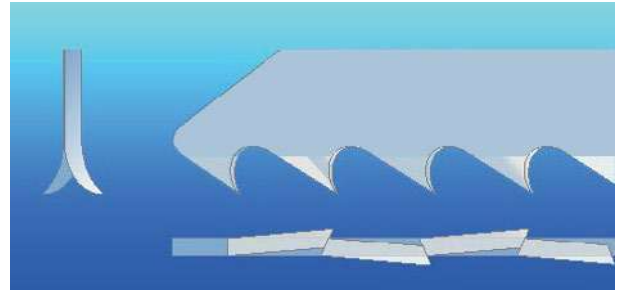

Milled and wavy set teeth

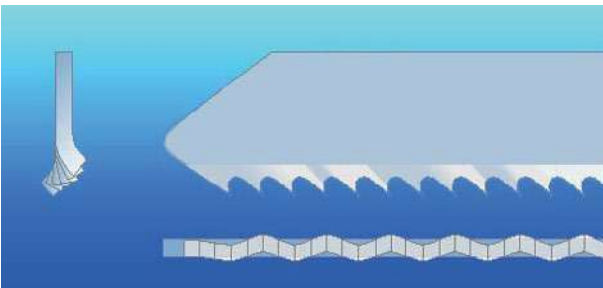

Ground and taper ground teeth

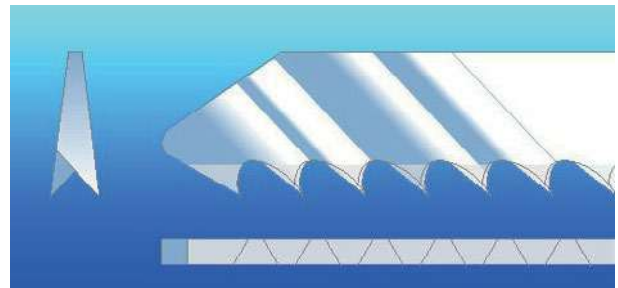

Teeth manufacture

Milled teeth

- Low cost type of manufacturing
- For general cutting
- Soft to hard materials
- Long blade life



Ground teeth

- Costly type of manufacturing
- Very sharp!
- Accurate, clean cut
- Soft to medium hard materials

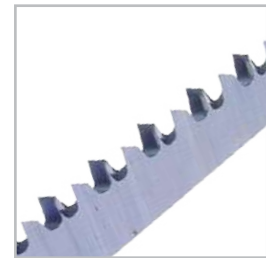

Production method

- **Side set:** each individual tooth is alternately bent to the left and to the right. Raker setting
Example: right, left, straight, etc.



- **Wavy set:** row of teeth receives a wave shape
- **Ground:** blade body tapers to the rear (conical)

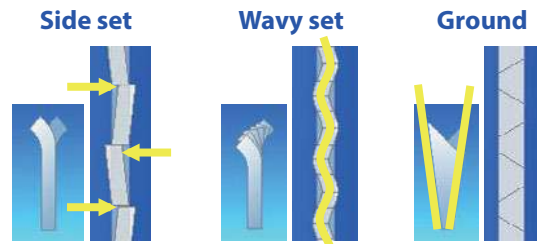

Jig Saw Blade material

- **HCS (High Carbon Steel)** for cutting softer materials such as wood or plastics.
- **HSS (High Speed Steel)** for cutting harder materials such as metals.
- **BiM (Bi-metal, HCS base and HSS teeth)** for cutting soft materials to hard materials such as wood, metal, plastics.
- **TC (Tungsten Carbide)** for cutting glass fiber reinforced plastic, cement-bonded fiberboards or plasterboard.

Jigsaw / Reciprosawing

Makita type Jig Saw blade



For Model:
4300BA/BV, 4326M, 4327M

Shape	No.	Wood Plywood (mm)	Plastics (mm)	Aluminum (mm)	Stainless Steel (mm)	Mild Steel (mm)	Features / Application	Working Length (mm)	Tooth Per Inch	Material	Type of cutting	Per pkg.	Part No.
-------	-----	-------------------	---------------	---------------	----------------------	-----------------	------------------------	---------------------	----------------	----------	-----------------	----------	----------

Wood/ Basic

	3	3-50	3-50	-	-	-	For general cutting	60	9	HCS		5	A-85868
	16	3-50	3-50	-	-	-	For scroll cutting	60	9	HCS		5	A-85830

Wood/ Fast

	8	4-50	4-50	-	-	-	For fast cutting	60	8	HCS		5	A-85911
--	---	------	------	---	---	---	------------------	----	---	-----	--	---	---------

Wood/ Finish

	9	4-50	4-50	-	-	-	For fast finish work	60	8	HCS		5	A-85927
	10	4-50	4-50	-	-	-	For fast finish work, especially suitable for plywood	60	9	HCS		5	A-85818
	10S	3-50	-	-	-	-	Splinter-free cuts in wood, requiring no sanding	62	13	HCS		5	A-85824
	BR-3	4-50	-	-	-	-	Splinter-free cuts in wood requiring no sanding	60	9	HCS		5	A-85933

Hardwood / Decorative veneers

	2	3-50	3-50	2-6	-	2-6	For decorative veneers.	60	14	HSS		5	A-85852
	4	3-50	3-50	3-6	-	3-6	For hardwood, thick mild steel plate and tough plastics	60	9	HSS		5	A-85874
	17	2-50	2-50	2-6	-	2-6	Ideal for scroll cutting of decorative veneer	63	14	HSS		5	A-85846

Finish for decorative veneers

	41	3-50	3-50	-	-	-	Reverse tooth for splinter-free cuts. for tough plastic and decorative veneers	60	12	HCS		5	A-85880
	42	2-50	2-50	-	-	-	For decorative veneer	60	16	HSS		5	A-85896

Metal/ Basic

	1	-	1-6	1-3	0.5-3	1-3	For mild steel. Also suitable for corrugated plastics and tough plastics	60	24	HSS		5	A-85802
	5	-	1.5-6	1-6	-	1-3	For mild steel	42	24	HSS		5	A-85905

Jigsaw / Reciprosawing

Bayonet type Jig Saw blade

For Model:

DJV181, DJV182, DJV180, JV183D, JV143D, JV0600, JV100D, JV101D, JV102D, JV103D, JV141D, JV142D
DJR185, JR102D, JR105D, 4326, 4327, 4328, 4329, 4350T/CT/FCT, 4351T/CT/FCT



Shape	No.	Wood Plywood (mm)	Plastics (mm)	Aluminum (mm)	Stainless Steel (mm)	Mild Steel (mm)	Features / Application	Working Length (mm)	Tooth Per Inch	Material	Type of cutting	Per pkg.	Part No.
-------	-----	-------------------	---------------	---------------	----------------------	-----------------	------------------------	---------------------	----------------	----------	-----------------	----------	----------

Super Express Jig saw Blade

	B-50	5-50	5-50	-	-	-	For fast finish work in wood and plastic	77	8.5-10.6	HCS	↑	5	B-06460
	B-51	-	-	-	1-3	1-8	Fast cut for mild steel, stainless steel	77	9.8-18.1	HSS	↑	5	B-06476
	B-52	5-50	5-50	3-35	3-5	3-8	Fast cut for universal materials	77	5.5-9.8	HSS	↑	5	B-06482

Wood/ Basic

	B-13	4-65	4-65	-	-	-	For general cutting	70	8	HCS	↑	5	A-85656
	B-15	3-35	3-35	-	-	-	Ideal for cutting thin materials	50	12	HCS	↑	5	A-85678
	B-14	2-35	2-35	-	-	-	Ideal for cutting thin materials	50	18	HCS	↑	5	A-85662
	B-18	2-35	2-35	-	-	-	For scroll cutting	45	14	HCS	↻	5	A-85709

Wood/ Fast

	B-15	4-65	4-65	-	-	-	For fast cutting	75	8	HCS	↑	5	A-86577
	B-16	5-65	5-65	-	-	-	For fast and rough cutting	75	6	HCS	↑	5	A-85684
	L-2	5-90	5-90	-	-	-	For fast and rough cutting	100	6	HCS	↑	5	A-86309
	B-16L	5-135	5-135	-	-	-	For fast and rough cutting	150	6	HCS	↑	5	792726-5
	B-17	5-60	5-60	-	-	-	For fast and scroll cutting	70	6	HCS	↻	5	A-85690
	B-8	4-65	4-65	-	-	-	Hook angle: 2 degrees	75	8	HCS	↑	5	A-85232











Wood/ Finish

	B-9	4-65	4-65	-	-	-	For fast finish work	75	8	HCS	↑	5	A-86583
	B-10	3-65	3-65	-	-	-	For fast finish work, especially suitable for plywood	75	9	HCS	↑	5	A-85628
	B-11	3-60	3-60	-	-	-	For fast finish work in wood and plastics	75	9	HCS	↑	5	A-85634
	B-10S	3-50	-	-	-	-	Splinter-free cuts in wood requiring no sanding	65	13	HCS	↑	5	792691-8
	B-12	5-65	5-65	-	-	-	For fast finish work in wood and plastics	75	6	HCS	↑	5	A-85640
	L-1	5-90	5-90	-	-	-	Ideal for cutting thick materials	100	6	HCS	↑	5	A-86290
	B-29	2-35	2-35	-	-	-	For scroll cutting	42	16	HCS	↻	5	A-80400
	BR-13	5-65	-	-	-	-	Splinter-free cuts in wood, requiring no sanding	64	9	HCS	↑	5	A-85793







Jigsaw / Reciprosawing

Shape	No.	Wood Plywood (mm)	Plastics (mm)	Aluminum (mm)	Stainless Steel (mm)	Mild Steel (mm)	Features / Application	Working Length (mm)	Tooth Per Inch	Material	Type of cutting	Per pkg.	Part No.
-------	-----	-------------------	---------------	---------------	----------------------	-----------------	------------------------	---------------------	----------------	----------	-----------------	----------	----------

Hardwood / Hard Plastic

	B-25	3-60	3-60	3-10	-	3-10	For hardwood, thick mild steel plate and hard plastics.	75	9	HSS		5	A-85765
	B-26	3-60	3-60	3-10	-	3-10	For scroll cutting in hardwoods and for hard plastics.	70	9	HSS		5	A-85771
	B-19	3-50	3-50	-	-	-	Reverse tooth for splinter-free cuts. For tough plastics and decorative veneers	65	12	HCS		5	A-85715
	B-53	3-50	3-50	-	-	-	Splinter-free cuts in laminate and plastics.	82	15	HCS		5	B-10970
	B-54	3-50	3-50	-	-	-	Splinter-free cuts in laminate and plastics.	82	18	HCS		5	B-10986



Metal/ Basic

	B-51	-	1.5-6	1.5-6	1-3	1-3	For mild steel	65	24	HSS		5	A-86561
	B-22	-	1-6	1-3	1-3	1-3	For mild steel, tough plastics. Especially for thin metal plate	50	24	HSS		2 5	B-01323 A-85737
	B-24	-	1-3	1-2	0.5-2	0.5-2	For very thin metal plate	50	32	HSS		5	A-85759
	B-23	3-35	3-35	2-6	-	2-6	For decorative veneers, medium-thick metal plate	50	14	HSS		5	A-85743
	B-27	-	1-6	1-3	1-3	1-3	For scroll cutting in mild steel	50	24	HSS		5	A-85787
	B-32	-	-Ø65	-Ø65	-	1.5-3	For thin metal plate, pipes and profiles. Also Aluminum and plastics.	107	18	HSS		5	B-10431
	B-33	-	-Ø65	-Ø65	-	2-3	For medium-thick metal plate, pipes and profiles. Also Aluminum	107	14	HSS		5	B-10447
	B-34	-	1.5-6	1.5-3	1.5-3	1.5-3	For mild steel, tough plastics. Especially for thin metal plate	50	18	HSS		5	B-10453
	B-35	*	-Ø114	2-6	-	-	For sandwich materials * Wood with nails -Ø120	154	14	Bi-Metal		5	B-10469

For Rubber

	B-K	-	-	-	-	-	Ideal for cutting of paper, cork, rubber, leather	75	-	HCS	-	5	A-80416
---	-----	---	---	---	---	---	---	----	---	-----	---	---	---------









For Fiber Cement

	B-60	-	-	-	-	-	Fiber Cement/Plaster Board 5-50, FRP/Plastic 5-20	75	6	TC/HM	-	3	B-06890
	B-61	-	-	-	-	-	Fiber Cement/Plaster Board 5-80, FRP/Plastic 5-50	105	6	TC/HM	-	3	B-06909

Economy type Jig Saw blade

For Model:

DJV181, DJV182, DJV180, JV183D, JV0600, JV100D, JV101D, JV102D, JV103D, JV141D, JV142D, DJR185, JR102D, JR105D, 4326, 4327, 4328, 4329, 4350T/CT/FCT, 4351T/CT/FCT

Shape	Wood Plywood (mm)	Plastics (mm)	Aluminum (mm)	Stainless Steel (mm)	Mild Steel (mm)	Features / Application	Working Length (mm)	Tooth Per Inch	Material	Type of cutting	Per pkg.	Part No.
	4-50	-	-	-	-	Wood / Basic	74	8	HCS		5	D-34877
	4-50	-	-	-	-	Wood / Fast	74	6	HCS		5	D-34883
	4-50	-	-	-	-	Wood / Fast, Curved	74	6	HCS		5	D-34899
	4-50	-	-	-	-	Wood / Finish	74	9	HCS		5	D-72718

Jigsaw / Reciprosawing

Jig Saw Blade 100pc/ pack

Type	No.	Application	Part No.
Bayonet type	B-10	Wood	B-07674
Makita type	No.1	Metal	B-07783
	No.2	Wood	B-07799
	No.3	Wood	B-07808



Jig Saw blade assortment

*Super Express Jig saw blade



Type	Five different jig saw blades in one packet					Part No.
Makita type	No.1	No.2	No.3	No.8	No.10S	A-86882
B type	B-10S	B-13	B-16	B-22	B-23	A-86898
B type	B-50	B-51	B-52	-	-	*B-06292

Recipro saw blades for Model JR1000FT, JR102D

HCS / High carbon steel for cutting softer materials such as wood or plastics HSS / High speed steel for cutting harder materials such as metals, Aluminum, and non-metals
For Cutting

Shape	No.	Wood Plywood (mm)	Plastics (mm)	Aluminum (mm)	Stainless Steel (mm)	Mild Steel (mm)	Features / Application	Working Length (mm)	Tooth Per Inch	Material	Type of cutting	Per pkg.	Part No.
-------	-----	-------------------	---------------	---------------	----------------------	-----------------	------------------------	---------------------	----------------	----------	-----------------	----------	----------





Wood/ Fast

	B-8	4-65	4-65	-	-	-	Ideal for fast cutting of wood and plastics. Hook angle: 2 degrees	75	8	HCS		5	A-85232
---	-----	------	------	---	---	---	--	----	---	-----	---	---	---------

Wood/ Finish

	B-10	3-65	3-65	-	-	-	For fast finish work, especially in plywood.	75	9	HCS		5	A-85628
---	------	------	------	---	---	---	--	----	---	-----	---	---	---------

Finish for decorative veneers

	B-19	3-50	3-50	-	-	-	Reverse tooth for splinter-free cuts. For tough plastics and decorative veneers	65	12	HCS		5	A-85715
	B-19S	3-25	3-25	-	-	-	Short type of B-19	43	12	HCS		5	B-04933

Metal/ Basic

	B-22	-	1-6	1-3	1-3	1-3	For mild steel, tough plastics. Especially for thin metal plate	50	24	HSS		2	B-01323
---	------	---	-----	-----	-----	-----	---	----	----	-----	---	---	---------

Metal/ Thin cutting

	B-24	-	1-3	1-2	0.5-2	0.5-2	For very thin metal plate	50	32	HSS		5	A-85759
---	------	---	-----	-----	-------	-------	---------------------------	----	----	-----	---	---	---------

For Paper, Cork, Rubber, Leather



Shape	No.	Foam polystyrene	Card board	Rubber	Leather	-	Features / Application	Working Length (mm)	Tooth Per Inch	Material	Type of cutting	Per pkg.	Part No.
	B-K	50	30	10	5	-	Ideal for cutting of paper, cork, rubber and leather.	75	-	HCS		5	A-80416

Jigsaw / Reciprosawing









Recipro saw blade

Type	Teeth per inch	Overall length (mm)	Blade thickness (mm)	Application	Tooth Material	Per pkg.	Part No.
------	----------------	---------------------	----------------------	-------------	----------------	----------	----------

Super Express Recipro saw Blade

	7-18	152	0.9	Fast cut for metal (Iron/steel 1.5-8.0mm, Plastic 5-77mm)	Bi-Metal	5	B-05038
	6-11	152	0.9	Fast cut for non-ferrous metal, aluminum, plastics, wood with nail, steel (Iron/steel 5-8mm, Plastic 5-77mm, Wood 5-77mm)	Bi-Metal	5	B-05044
	6-10	203	1.0	Fast cut for wood	HCS	5	B-05153

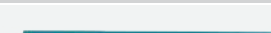
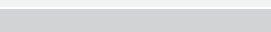
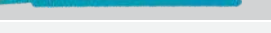
For Metal / Basic

No.22 	18	165	1.0	For steel plate, aluminum 3.0mm-5.0mm. For iron pipe 90 mm dia. or less.	HSS	5	792147-1
No.24 	24	165	1.0	For steel plate 1.5mm-3.0 mm. For iron pipe 90 mm dia. or less.	HSS	5	792149-7
	14	152	0.9	metal plate 3-8mm pipe 10-100mm	Bi-Metal	5	B-16841
	14	225	0.9	metal plate 3-8mm pipe 10-175mm	Bi-Metal	5	B-16776
	18	100	0.9	For thin metal 1.5-4.0mm.	Bi-Metal	5	B-20404
	18	152	0.9	For thin metal 1.5-4.0mm. For iron pipe 100mm dia or less.	Bi-Metal	5	B-05169
	18	225	0.9	metal plate 1.5-4mm pipe 5-175mm	Bi-Metal	5	B-16782
	24	152	0.9	metal plate 0.7-3mm pipe 5-100mm	Bi-Metal	5	B-16835
	24	225	0.9	metal plate 0.7-3mm pipe 5-175mm	Bi-Metal	5	B-43169
	10-14	305	0.9	metal tubing 5-200mm, Aluminum & plastic 5-20mm	Bi-Metal	5	B-16857



For Metal / Heavy

	14+18	152	1.1	metal plate 3-8mm, pipe <100mm	Bi-Metal	5	B-43131
	14+18	225	1.1	metal plate 3-8mm, pipe <175mm	Bi-Metal	5	B-43175
	14+18	305	1.1	metal plate 3-8mm, pipe <250mm	Bi-Metal	5	B-43206
	8+10	152	1.1	thick sheet metal 4-12mm, pipe <100mm (fast cut)	Bi-Metal	5	B-43147
	8+10	225	1.1	thick sheet metal 4-12mm, pipe <175mm (fast cut)	Bi-Metal	5	B-43181
	8+10	305	1.1	thick sheet metal 4-12mm, pipe <250mm (fast cut)	Bi-Metal	5	B-43212
	10-14	152	1.25	thick sheet metal 2-10mm, pipe <100mm (fine cut)	Bi-Metal	5	B-43153
	10-14	225	1.25	thick sheet metal 2-10mm, pipe <175mm (fine cut)	Bi-Metal	5	B-43197

Jigsaw / Reciprosawing

Type	Teeth per inch	Overall length (mm)	Blade thickness (mm)	Application	Tooth Material	Per pkg.	Part No.
	10-14	305	1.25	thick sheet metal 2-10mm, pipe <250mm (fine cut)	Bi-Metal	5	B-43228

For Metal / Heavy / Curve shape

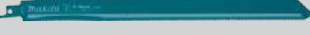
	14+18	152	1.1	metal plate 3-8mm, pipe <100mm	Bi-Metal	5	B-55815
	14+18	225	1.1	metal plate 3-8mm, pipe <175mm	Bi-Metal	5	B-55821
	14+18	305	1.1	metal plate 3-8mm, pipe <225mm	Bi-Metal	5	B-55837

TC Reciprosaw Blade





Tungsten Carbide Tip





Application



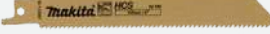

For Metal / Heavy / TC

	8	100	1.25	thick sheet metal 4-12mm, pipe <50mm	TC/HM	1	B-55566
	8	152	1.25	thick sheet metal 4-12mm, pipe <100mm	TC/HM	1	B-55572
	8	228	1.25	thick sheet metal 4-12mm, pipe <175mm	TC/HM	1	B-55588
	8	305	1.25	thick sheet metal 4-12mm, pipe <250mm	TC/HM	1	B-55594

For Wood / Basic

No.3020 	10	150	1.0	For wood, plywood 5mm-90mm	HCS	5	A-02319
	10	152	0.8	soft wood, chipboard, wood core plywood <100mm	HCS	5	B-16807
No.3023 	10	250	1.25	For thick wood 5mm-190mm	HCS	5	B-00767

For Wood / Fast

No.23B 	6	150	1.0	For fast finish work in wood 10mm-90mm	HCS	5	792707-9
No.3019 	4	150	1.0	For fast and rough cutting in thick wood. 20mm-90mm	HCS	5	A-02303
No.3030 	6	300	1.25	For roughing work on thick wood. 10mm-250mm	HCS	5	B-03030

Jigsaw / Reciprosawing

Type	Teeth per inch	Overall length (mm)	Blade thickness (mm)	Application	Tooth Material	Per pkg.	Part No.
------	----------------	---------------------	----------------------	-------------	----------------	----------	----------

Japanese Teeth Reciprosaw Blade

1. Japanese teeth for Sharp Edge!

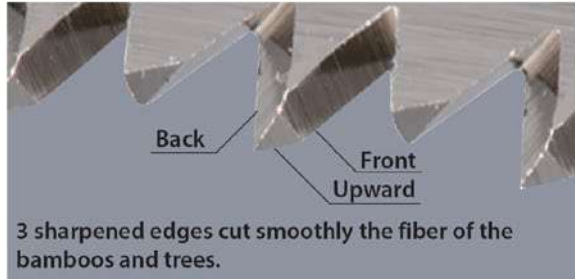

2. Clean Cutting Surface



Application

For Bamboo

15TPI



For Green Wood

8.5TPI



for Wood / Clean cut

	8.5	190	0.6	For planting green wood ϕ100mm, wood <math>< 100\text{mm}</math>	HCS	1	B-56580
	15	190	0.6	For bamboo <math>< \phi 100\text{mm}</math>, wood <math>< 100\text{mm}</math>, PVC <math>< \phi 100\text{mm}</math>	HCS	1	B-56596
	8.5	225	0.9	For planting green wood <math>< \phi 140\text{mm}</math>, wood <math>< 140\text{mm}</math>	Bi-Metal	1	B-57386
	15	225	0.9	For bamboo <math>< \phi 140\text{mm}</math>, wood <math>< 140\text{mm}</math>, PVC <math>< \phi 140\text{mm}</math>	Bi-Metal	1	B-57392

for Wood and Metal





*White Lacquered, **Unlacquered

	6	152	1.25	For wood with nails 10mm-100mm, Glass Fiber 8-50mm	Bi-Metal	5	B-05175
	10	152	0.9	For pallets, wood with nails 5-100mm sheet metal, pipes, aluminum profiles 3-12mm	Bi-Metal	5	B-31843
	10	228	0.9	For pallets, wood with nails 5-175mm sheet metal, pipes, aluminum profiles 3-12mm	Bi-Metal	5	B-31859
	5-8	305	1.25	Wood with nails/metal, chipboards (10-250mm), aerated concrete (10-250mm), plastics/Glass fibre reinforced plastics, profiles (5-60mm)	Bi-Metal	3	B-10637
	10-14	152	0.9	wood with metal 5-100mm, aluminum 3-10mm, plastic 3-100mm	Bi-Metal	5	B-43240
	10-14	225	0.9	wood with metal 5-175mm, aluminum 3-10mm, plastic 3-175mm	Bi-Metal	5	B-43262



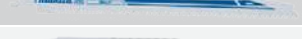

Jigsaw / Reciprosawing

Type	Teeth per inch	Overall length (mm)	Blade thickness (mm)	Application	Tooth Material	Per pkg.	Part No.
------	----------------	---------------------	----------------------	-------------	----------------	----------	----------

For Wood and Metal / Heavy

	5-8	152	1.6	wood with metal, chipboard 10-100mm	Bi-Metal	5	B-43234
	5-8	225	1.6	wood with metal, chipboard 10-175mm	Bi-Metal	5	B-43256
	5-8	305	1.6	wood with metal, chipboard 10-235mm	Bi-Metal	5	B-43278
	6-8	152	1.25	Wood with nails/metal, chipboards (5-100mm), plastics/Glass fibre reinforced plastics (<100mm)	TC/HM	1	B-49834
	6-8	228	1.25	Wood with nails/metal, chipboards (5-175mm), plastics/Glass fibre reinforced plastics (<175mm)	TC/HM	1	B-49840
	6-8	305	1.25	Wood with nails/metal, chipboards (5-250mm), plastics/Glass fibre reinforced plastics (<250mm)	TC/HM	1	B-49856

For Special Purpose

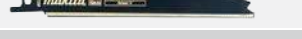
	-	225	1.5	Insulation Material, Glass Wool, Stone Wool (10-175mm)	HCS	2	B-52118
	-	300	1.5	Insulation Material, Glass Wool, Stone Wool (10-250mm)	HCS	2	B-52124
	-	400	1.5	Insulation Material, Glass Wool, Stone Wool (10-300mm)	HCS	1	B-52130
	18	152	1.0	For stainless steel plate 2mm-4mm, stainless steel pipe 80mm dia or less, fiber glass	TC/HM	2	B-07250
	-	225	1.0	Cast-steel pipe 150mm dia or less, for red brick 10-175mm, FRP/Epoxy 3-175mm	Diamond Grit	2	B-31871

For Ice/Frozen Material



	3	305	1.25	For Ice 10-250 mm	Stainless Steel	1	B-10609
	6	228	1.2	For Ice 10-175 mm	Stainless Steel	1	B-30564
	10	228	1.2	For Ice 10-175 mm	Stainless Steel	1	B-30570

Economy type Recipro saw blade

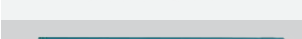
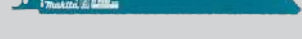

Type	Teeth per inch	Overall length (mm)	Blade thickness (mm)	Application	Tooth Material	Per pkg.	Part No.
------	----------------	---------------------	----------------------	-------------	----------------	----------	----------

For Metal

	18	152	0.9	metal plate 1.5-4mm pipe 5-100mm	Bi-Metal	2	D-51633
	18	225	0.9	metal plate 1.5-4mm pipe 5-175mm	Bi-Metal	2	D-51661
	24	152	0.9	metal plate 0.7-3mm pipe 5-100mm	Bi-Metal	2	D-51649
	24	225	0.9	metal plate 0.7-3mm pipe 5-175mm	Bi-Metal	2	D-51677

Jigsaw / Reciprosawing

Board Cutter Blade



For Model:
DSD140, DSD180, SD100D

Blade length (mm)	Blade width (mm)	Blade thickness (mm)	Application	Tooth Material	Per pkg.	Part No.
55	18	0.55	Plasterboard (<30mm)	HCS	2	B-49703
55	18	0.55	Wood (<30mm)	HCS	2	B-49719

Scroll Saw Blade

For model: SJ401

Application	No of teeth per inch	Pc per pkg.	Part No.
Straight line and large curve on wood	60	5	A-31099
Optimal switching curve and small area on wood	70	5	A-31108



Band Saw Blade

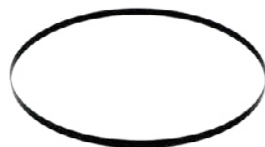

Teeth shape (Image)

Wave teeth



Raker teeth



Model No.	Type	Width (mm)	No. of teeth per inch	Teeth shape	Application	Part No.
-----------	------	------------	-----------------------	-------------	-------------	----------

Width : 13 mm, Thickness : 0.5 mm, Length : 730 mm

DPB184	Bi-Metal (5pc.)	More than 5 mm	14		Plastics and non-ferrous metal. Mild steel, cast steel and cast iron. Hard steel and stainless steel.	E-04101
		4 mm- 5 mm	18			E-04117
		Less than 4 mm	24			E-04123

Width : 13 mm, Thickness : 0.5 mm, Length : 835 mm

DPB181 DPB182	Bi-Metal (5pc.)	More than 5 mm	14		Plastics and non-ferrous metal. Mild steel, cast steel and cast iron. Hard steel and stainless steel.	B-40543
		4 mm- 5 mm	18			B-40559
		Less than 4 mm	24			B-40565

Width : 13 mm, Thickness : 0.5 mm, Length : 1,140 mm

DPB180, 2107F, 2107FW	Carbon steel (3pcs./set)	More than 5 mm	14		Plastics and non-ferrous metal. Mild steel, cast steel and cast iron.	792560-3
		4 mm- 5 mm	18			792559-8
		Less than 4 mm	24			792558-0
	Bi-Metal (1pc.)	More than 5 mm	10		Plastics and non-ferrous metal. Mild steel, cast steel and cast iron. Hard steel and stainless steel.	B-30128
		More than 5 mm	14			792557-2
		4 mm- 5 mm	18			792556-4
		Less than 4 mm	24			194692-6

Thickness : 0.5 mm, Length : 2,240 mm

LB1200F	Carbon steel (3pcs./set)	16	4		Wood/ for cross-cut	B-16667
		13	4		Wood/ for universal	B-16673
		6	6		Wood/ for curve-cut	B-16689
		16	14		Nonferrous metal	B-16695

ACCESSORIES

▣ Brushing



Hook and loop
type



6mm
6mm cylindrical
shank.

Brushing

Brushes for Grinder

Shape type

Cup Type



Effective for flat or rugged surface

Wheel Type



Effective for working at spot

Bevel Type



Effective for working at corner

Wire brush

For Model:

A: 100mm Disc / Angle Grinder

B: 125, 150mm Angle Grinder

C: 180, 230mm Angle Grinder

D: 230mm Angle Grinder

Wire wheel brush, Knotted wire

0.5mm knotted steel wire

(Effective for heavy duty cleaning at spot.)



Wire Cup brush, Crimped wire

0.3mm crimped steel wire
(Ideal for light rust removal
from flat surfaces and edges.)



For Model	Size	Spindle thread	Part No.
A	60mm	M10 x 1.5	D-24066
B	60mm	M14 x 2	D-24072
A	75mm	M10 x 1.5	D-24088
B	75mm	M14 x 2	D-24094
C	100mm	M14 x 2	D-29284

For Model	Size	Spindle thread	Part No.
B, C	100mm	M14 x 2	D-29555
B, C	115mm	M14 x 2	D-29561
B, C	125mm	M14 x 2	D-29577
D	175mm	M14 x 2	D-45777

Wire Cup brush, Crimped wire, brass-coated

0.3mm Brass coated steel wire
(Ideal for light rust removal.
Prevented from wire corrosion.)



For Model	Size	Spindle thread	Part No.
C	90mm	M14 x 2	D-39780

Slit paper wheel 120-40

(For rust and paint removal)

For Model:

9741



Part No.

794380-1

Wire Cup brush, Knotted wire

0.5mm knotted steel wire
(Ideal for heavy work
for fast cleaning of large surface.)



For Model	Size	Spindle thread	Part No.
A	60mm	M10 x 1.5	D-24103
A	75mm	M10 x 1.5	D-24125
B	75mm	M14 x 2	D-24131

Nylon brush wheel

For Model:

9741



Application

120-80 Coarse

120-240 Fine

Part No.

794384-3

794383-5

Wire Cup brush, Knotted wire 2

0.5mm knotted steel wire
(Ideal for especially heavy work.)



For Model	Size	Spindle thread	Part No.
A	60mm	M10 x 1.5	D-24147
C	100mm	M14 x 2	D-29290

Nylon brush set for drill - 3 pcs

For driver drill.

Diameter for cup brush: 50mm, wheel brush: 50mm and end brush: 24mm



Description

Coarse Grit 80

Fine Grit 240

Part No.

D-70742

D-70758

ACCESSORIES

▣ Bonded Abrasive



Flexible



Always use
back up pad



Fast cut



3mm
3mm cylindrical
shank



6mm
6mm cylindrical
shank

Bonded Abrasive

New Label design



Lot number : printed in label

Validity : on washer (If there is not on washer, there is on label.)

Point 1 The icon tell that how to use.

	for metal	for INOX	for Masonry	for Aluminum
Grinding				
Cutting for grinder				
Cutting for portable cut-off		—	—	—
Cutting for power cutter		—	—	—

Bonded Abrasive

Point 2 The marks tell the range in makita.



performance more good

Point 3 How to read the spec.



Aluminum Oxide Group (mainly for metal & INOX)

Brown Fused Aluminum: A

The most common abrasive material for metal.



Single Aluminum Oxide: SA

Single crystal abrasive material with high tenacity. Higher durability and grinding/cutting performance than A.



White Aluminum Oxide: WA

High purity abrasive material, eliminated extraneous elements from A. Higher grinding and cutting performance than A.



Alumina Zirconium: Z

Extremely sharp and hard abrasive material. Grinding/cutting performance than SA.



Ceramic:



Extremely sharp and high resistant to shock/heat/wear. High grade abrasive material with excellent grinding performance and durability.

Silicon Oxide Group (mainly for non-metallic)

Black Silicon Carbide: C

The most common abrasive material for non-metal.



Green Silicon Carbide: GC

Higher purity than C, eliminated extraneous elements, thus having higher grinding and cutting performance than C, but a little lower durability than C.

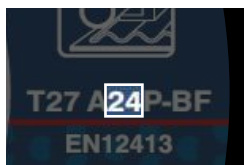

Grit Size

24

36

60

80

120

Coarse



Fine

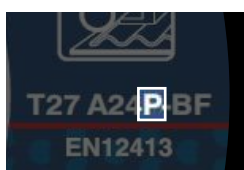

Hardness of grinding wheel

Closer to A, softer grinding wheel is
Closer to Z, harder grinding wheel is

Soft grinding wheel ▶ Hard work piece

Hard grinding wheel ▶ Soft work piece

Very Soft	Soft	Middle	Hard	Very Hard
A - G	H - K	L - O	P - S	T - Z

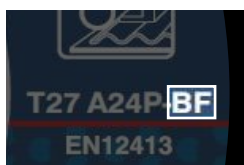

Type of Bond

BF : Reinforced resinoid bond
V : Vitrified bond

Point 4 The color tell the application.

	for metal	for INOX	for Masonry	for Aluminum
color	 Blue	 Orange	 Green	 Gray

Bonded Abrasive

Grinding wheel/ Metal/ Depressed



Three-star range

★★★

Size (mm)	Grit	Per pkg	Part No.
100 x 4 x 16	A36P	1	A-80905(EN)
100 x 6 x 16	A36P	1	A-80911(EN)
125 x 6 x 22.23	A36P	1	A-80933(EN)
150 x 6 x 22.23	A36P	1	A-84981(EN)
180 x 6 x 22.23	A36P	1	A-80949(EN)
230 x 6 x 22.23	A36P	1	A-80955(EN)

Two-star range

★★

Size (mm)	Grit	Per pkg	Part No.
100 x 6 x 16	A24R	1	D-18443(EN)
125 x 6 x 22.23	A24R	1	D-18465(EN)
180 x 6 x 22.23	A24R	1	D-18471(EN)
230 x 6 x 22.23	A24R	1	D-18487(EN)

One-star range

★

Size (mm)	Grit	Per pkg	Part No.
100 x 6 x 16	A24P	1	D-72241(EN)

Grinding wheel/ Metal/ Depressed with X-LOCK



X-LOCK

Grinding wheel/ Metal

Size (mm)	Grit	Per pkg	Part No.
100 x 6 x 22.23	A36P	1	E-00480(EN)
115 x 6 x 22.23	A36P	1	E-00365(EN)
125 x 6 x 22.23	A36P	1	E-00393(EN)

Grinding wheel/ Stainless

Size (mm)	Grit	Per pkg	Part No.
100 x 6 x 22.23	WA36N	1	E-00496(EN)
115 x 6 x 22.23	WA36N	1	E-00371(EN)
125 x 6 x 22.23	WA36N	1	E-00402(EN)

Thin Cut-off wheel (Flat)

Size (mm)	Grit	Per pkg	Part No.
100 x 1.2 x 22.23	A60T	1	E-00505(EN)
125 x 1.2 x 22.23	A60T	1	E-00418(EN)

Grinding wheel/ Stainless/ Depressed



Three-star range

★★★

Size (mm)	Grit	Per pkg	Part No.
100 x 6 x 16	WA36N	1	A-80852(EN)
180 x 6 x 22.23	WA36O	1	A-80880(EN)
230 x 6 x 22.23	WA36O	1	A-80896(EN)



Bonded Abrasive

Grinding wheel for Heavy Industries



1. 7.2mm thickness for Heavy Industries. It is suitable to use with a high power grinder.



2. Longer Life

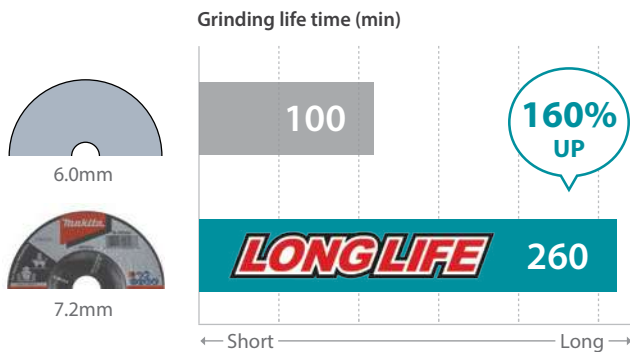

Three-star range
★★★

Size (mm)	Grit	Per pkg	Part No.
100 x 6 x 16	A24R	1	B-21107(EN)
180 x 6 x 22.23	A24R	1	B-21135(EN)

Flexible grinding wheel/ Metal



1. Less noise
2. Low vibration
3. As flexible grinding wheel cause almost no tapping, it provides excellent workability
4. Wide range of Applications



Three-star range
★★★

Size (mm)	Grit	Per pkg	Part No.
100 x 3 x 16	AC60	1	B-18253(EN)

Bonded Abrasive

Flexible grinding wheel/ Stainless/ Depressed



Always use back-up pad

Three-star range
★★★

Size (mm)	Grit	Per pkg	Part No.
100 x 3 x 16	WA60	1	B-18487(EN)



Back up pad for Flexible grinding wheel



Size (mm)	Per pkg	Part No.
for 100mm	1	B-20476
for 180mm	1	B-20498

Flexible grinding wheel ideal for cordless angle grinder



1. Amount of grinding per 1 charged 70% up than grinding wheel/ stainless.
2. Vibration 60% off than grinding wheel/ stainless.



Needless to use Back up pad

Four-star range
★★★★

Size (mm)	Grit	Per pkg	Part No.
100 x 4.0 x 16	WA36P	1	B-52392(EN)

Bonded Abrasive

Ultra thin cut-off wheel/ Stainless/ Flat/ Ideal for Cordless angle grinder



1. Cutting speed 40% up than 1.0mm cutting.
2. Number of cut with 1 charge 20% up than 1.0mm cutting.
3. Less burr of materials



4. Less dust of materials



Four-star range
★★★★

Type A: Flat wheel

Type B: Depressed center wheel

Size (mm)	Grit	Type	Per pkg	Part No.
100 x 0.8 x 16	Z60U	A	1	E-10855(EN)
125 x 0.8 x 22.23	Z60U	A	1	E-10877(EN)

Cut-off wheel for Portable cut-off/ Metal stud/ Ideal for Cordless Portable cut-off



Specialize

Size (mm)	Grit	Rough or Smooth	G.F. Q'ty	Per pkg	Part No.
355 x 2.5 x 25.4	A36P	-	2.0G	5	B-64696 (EN)

Thin cut-off wheel/ Stainless/ Flat



Four-star range
★★★★

Size (mm)	Grit	Type	Per pkg	Part No.
100 x 1.0 x 16	A60V	A	1	E-17108 (EN)

Three-star range
★★★

Size (mm)	Grit	Type	Per pkg	Part No.
100 x 1.0 x 16	A60T	A	1	B-12201(EN)
100 x 1.0 x 16	A60U	A	1	E-03028 (EN)
100 x 1.0 x 16	A60U	A	12 (Plastic case)	E-03028-12 (EN)
115 x 1.0 x 22.23	A60T	A	1	D-65947(EN)
125 x 1.0 x 22.23	A60T	A	1	B-12239(EN)
150 x 1.6 x 22.23	A60U	A	1	E-13742(EN)
180 x 1.6 x 22.23	A60T	A	1	B-12267(EN)
230 x 1.9 x 22.23	A60T	A	1	B-12273(EN)
230 x 2 x 22.23	WA36R	A	1	E-03006(EN)

Size (mm)	Grit	Type	Per pkg	Part No.
-----------	------	------	---------	----------



Two-star range
★★

100 x 1.0 x 16	WA60T	A	1	D-18758(EN)
100 x 1.0 x 16	WA46R	A	1	D-65947(EN)
125 x 1.2 x 22.23	WA60T	A	1	D-18770(EN)
125 x 1.2 x 22.23	WA60T	A	10 (Can)	D-18770-10(EN)
125 x 1.0 x 22.23	WA46R	A	1	D-65969(EN)
180 x 2 x 22.23	WA46R	A	1	D-65975(EN)

Bonded Abrasive

Cut-off wheel/ Metal/ Flat/ Depressed



Three-star range
★★★

Type A: Flat wheel
Type B: Depressed center wheel



Size (mm)	Grit	Type	Per pkg	Part No.
100 x 2.5 x 16	A30R	A	1	A-85298 (EN)
125 x 2.5 x 22.23	A30R	A	1	A-85313(EN)
150 x 3 x 22.23	A30T	B	1	B-05050(EN)
180 x 2.5 x 22.23	A30R	A	1	A-85329(EN)
230 x 2.5 x 22.23	A30R	A	1	A-85335(EN)
230 x 3 x 22.23	A30T	B	1	A-83624(EN)

Two-star range
★★

Size (mm)	Grit	Type	Per pkg	Part No.
100 x 3 x 16	A30S	B	1	D-18552(EN)
125 x 2.5 x 22.23	A30S	A	1	D-18677(EN)
150 x 2.5 x 22.23	A30S	A	1	D-29402(EN)
180 x 3 x 22.23	A30S	B	1	D-18580(EN)
230 x 2.5 x 22.23	A30S	A	1	D-18699(EN)

Grinding wheel/ Stainless/ Depressed/ 2in1/ Ideal for Cordless angle grinder



- Cutting speed 10% up than 2 in 1 wheel.
- Number of cut with 1 charge 80% up than 2 in 1 wheel.

Cutting



Deburring



Appropriate wheel cover is required

Three-star range
★★★

Size (mm)	Grit	Per pkg	Part No.
100 x 2.2 x 16	SA46P	1	B-51649 (EN)
125 x 2.2 x 22.23	SA46P	1	B-51655 (EN)

Thin cut-off wheel for Portable cut-off/ Metal

- Thinner blade & the optimum bonding



- Ideal for cordless tools

The amount of cutting per 1 charge

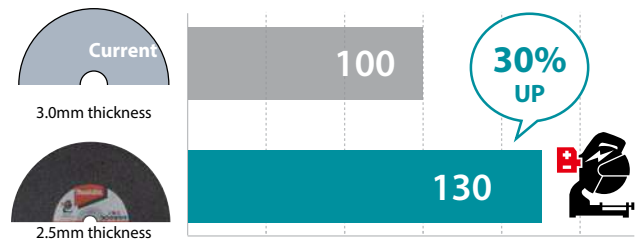

* The test results depend to a great extent on the hardness of materials, etc.

* The number in the bar graphs are relative values when the capacity of current wheel is indexed at 100.

Three-star range
★★★

Size (mm)	Grit	Texture	G.F. Q'ty	Part No.
305 x 3 x 25.4	A36P	Rough	1.0G	A-88456
305 x 3 x 25.4	A36P	Smooth	1.0G	A-87650
355 x 3 x 25.4	A30P	-	2.0G	B-16891
355 x 3 x 25.4	A36P	Smooth	1.0G	A-89545
405 x 3 x 25.4	A36P	Rough	1.0G	A-88478

Two-star range
★★

355 x 3 x 25.4	A36T	Rough	1.0G	E-10540
----------------	------	-------	------	---------

Bonded Abrasive

Tungsten carbide burrs

Cut and application

Standard cut

<Feature> High efficiency
<Surface> Rough
<Material> Metal, Stainless



Diamond cut

<Feature> Less vibration
<Surface> Smooth
<Material> Metal, Stainless



Non-farreous cut

<Feature> Less clogging up
<Surface> Rough
<Material> Non-ferrous, Plastic



Shape and application

Shape: SA



Clean the burrs on inox



Shape: SC



Deburr of aluminium



Shape: SF



Shape: SL



Wipe the welding line between steel plate



Shape: SM



Tungsten carbide burrs/ mm type

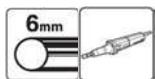

Three-star range

★★★



Shape	Grit	Bit dia. mm	Working length mm	Shank mm	Sales Pkg Qty	Part No.
SA	Diamond cut	10	20	6	10	B-52722
SC		10	20	6	10	B-52750
SF		10	20	6	10	B-52788
SL		10	25	6	10	B-52819
SM		10	20	6	10	B-52847
SA	Standard cut	10	20	6	10	B-52716
SC		10	20	6	10	B-52744
SF		10	20	6	10	B-52772
SL		10	25	6	10	B-52803
SM		10	20	6	10	B-52831
SA	Non-ferrous cut	10	20	6	10	B-52738
SC		10	20	6	10	B-52766
SF		10	20	6	10	B-52794
SL		10	25	6	10	B-52825
SM		10	20	6	10	B-52853

Grinding wheel for Bench grinder



Size (mm)	Grit	Part No.
150 x 16 x 12.7	A36M	B-51904 (EN)
150 x 16 x 12.7	WA60K	B-51926(EN)
150 x 16 x 12.7	GC120H	B-51932 (EN)
205 x 19 x 15.88	A36P	B-51948 (EN)
205 x 19 x 15.88	A60P	B-51954 (EN)
205 x 19 x 15.88	WA60K	B-51960(EN)
205 x 19 x 15.88	GC120H	B-51976 (EN)

Grinding wheel for Straight grinder



Size (mm)	Grit	Part No.
125 x 19 x 12.7	24P	741015-5
125 x 19 x 12.7	36P	741016-3

Wheel Point

Application:

A: Mild steel, carbon steel, etc.

WA: Hardened and special steels.

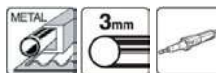

No.	Per pkg.	Wheel dia. (mm)	Shank size (mm)	Type	Part No.
For Model: 903, 906, GD0800C, GD0810C, GD0600, BGD800, BGD801					
1	10	5	3	A	794050-2
1	10	8	3	A	794052-8
1	10	10	3	A	794053-6
2	10	5	3	WA	794054-4
2	10	6	3	WA	794055-2
3	10	10	3	A	794059-4

For Model:

906, GD0800C, GD0810C, GD0600, BGD800, BGD801

No.	Per pkg.	Wheel dia. (mm)	Shank size (mm)	Type	Part No.
1	1	19	6	WA	741614-3
1	1	19	1/4"	WA	741617-7
4	1	19	6	WA	741615-1
4	1	19	1/4"	WA	741616-9

ACCESSORIES

Coated Abrasive



Thread for
Cordless sander
polisher



No wet use by
powertool



Hand sanding



Hand sanding
(wet)



Long life



12100rpm



6mm
6mm cylindrical
shank

Coated Abrasive

New Label design



Point 1 The icon tell that how to use.

	for metal	for INOX	for Masonry
Grinding			

Point 2 The marks tell the range in makita.

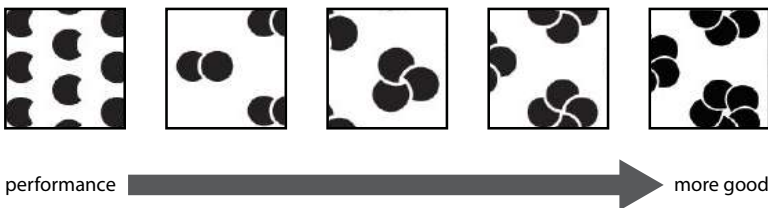

Point 3 Grain and Grit

Aluminum Oxide Group (mainly for metal & INOX)

Grain

Brown Fused Aluminum: A
The most common abrasive material for metal.



Alumina Zirconium: Z
Extremely sharp and hard abrasive material.
Grinding/cutting performance than SA.



Silicon Oxide Group (mainly for non-metallic)

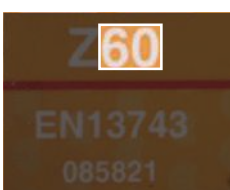
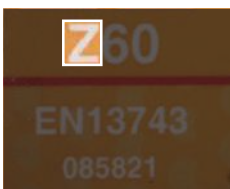

Black Silicon Carbide: C
The most common abrasive material for non-metal.

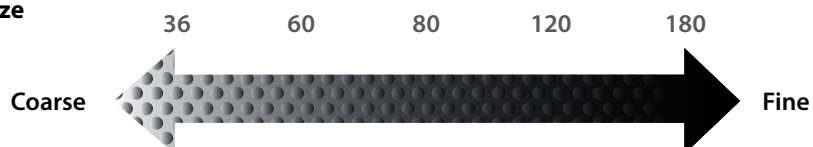

Grit Size



Point 4 The color tell the application.

	for metal	for INOX	for Masonry
color	 Blue	 Orange	 Green

Backing Type



Fiber glass backing
Standard backing type



Nylon backing
For heavy duty

Shape Type





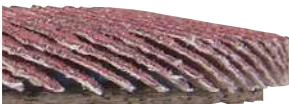







Flat
Effective for flat surface



Angled
Effective for angles or corners

Material chart

Recommended Acceptable

Description of Grit material		 Aluminum oxide	 Zirconia alumina	 Silicon carbide
Description of label color		Best for metal 	Best for INOX and metal 	Best for Masonry 
Plastic		A		
Metal		AA	AA	
No ferrous		A	A	
INOX			A	
Masonry				AA

*After reading instruction manual of grinder, please chose work material.

Coated Abrasive

Flap disc aluminum oxide/ Fiberglass backing/ Angled

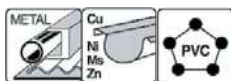

One-star range



Backing Type	Backing Shape	Dia (mm)	Hole Dia (mm)	Grit	Part No.
Fiber Glass	Angled	100	16	A40	D-63395(EN)
			16	A60	D-63404(EN)
			16	A80	D-63410(EN)
			16	A120	D-63426(EN)
		125	22.23	A40	D-63476(EN)
			22.23	A60	D-63482(EN)
			22.23	A80	D-63498(EN)
			22.23	A120	D-63507(EN)
		180	22.23	A40	D-63513(EN)
			22.23	A60	D-63529(EN)
			22.23	A80	D-63535(EN)
			22.23	A120	D-63541(EN)



Zirconia Aluminum flap disc



One-star range



Backing Type	Backing Shape	Dia (mm)	Hole Dia (mm)	Grit	Part No.	
Fiber Glass	Angled	100	16	Z40	D-63703(EN)	
			16	Z60	D-63719(EN)	
			16	Z120	D-63725(EN)	
			16	Z120	D-63731(EN)	
			125	22.23	Z40	D-63781(EN)
				22.23	Z60	D-63797(EN)
				22.23	Z80	D-63806(EN)
				22.23	Z120	D-63812(EN)
		180	22.23	Z40	D-63828(EN)	
			22.23	Z60	D-63834(EN)	
			22.23	Z80	D-63840(EN)	
			22.23	Z120	D-63856(EN)	

Coated Abrasive

Aluminum Flexible Flap Disc

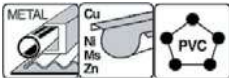

High flexibility



Suitable for grinding on CURVE/EDGE/CORNER surface.



Two-star range
★★

Backing Type	Backing Shape	Dia (mm)	Hole Dia (mm)	Grit	Part No.
Backing Less	 Flat	100	16	A40	D-62686(EN)
			16	A60	D-62692(EN)
			16	A80	D-62701(EN)
			16	A120	D-62717(EN)

Strip disc/ Fiberglass backing



Special tool for stripping work

Grit (SiC)

It is covered with glue with Sic (Silicon Carbide), enables you to grind quickly with less power.

Fiber

Entangled fiber acts as a cushion material and prevents from grinding too much and scratching steel.

The surface condition of strip disc is the finest.



Removing Paint, Removing Rust, Removing blue weld discoloration



Color	Type	Speed	Life
Black	 Standard	100%	100%

Backing Type	Dia (mm)	Hole Dia (mm)	Part No.
 Fiber Glass	100	16	B-28961
	125	22.23	B-28983
	180	22.23	B-28999

Coated Abrasive

Surface conditioning flap disc/ Angled/ Coarse



1. Grinding and surface conditioning of metal in one step.
2. Suitable for polishing after grinding by flap disc.
3. Usable for stainless and metal.

How to use



Removing blue weld discoloration



Removing Rust

Polishing after grinding by flap disc

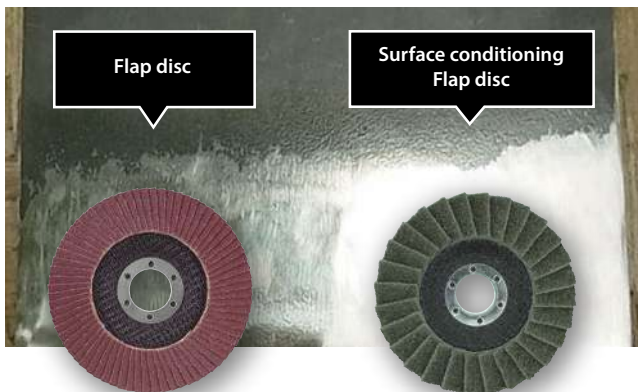

Backing Type	Backing Shape	Dia (mm)	Hole Dia (mm)	Grit	Part No.
Fiber Glass	Angled	100	16	Coarse	B-40711
			16	Medium	B-40727
			16	Fine	B-40733
			16	Very Fine	B-40749
	Flat	100	16	Coarse	B-40870
			16	Medium	B-40886
			16	Fine	B-40892
			16	Very Fine	B-40901

Fiber sanding disc

Use with backing pad.



**For Model: GV6010 only

Dia (mm)	Grit	Hole Dia (mm)	Per Pkg.	Part No.
125	C80	22	10	794099-2
	C120	22	10	794100-3
150	**C80	12.7	10	794088-7
	**C120	12.7	10	794090-0
	C50	22	10	794072-2
	C80	22	10	794073-0
	C50	22	10	794094-2
180	C80	22	10	794095-0
	C100	22	10	794220-3



Coated Abrasive

Accessory for 75mm Sander Polisher

How to use

1. Use with adapter (743126-2)

2. Use with pad (743124-6)

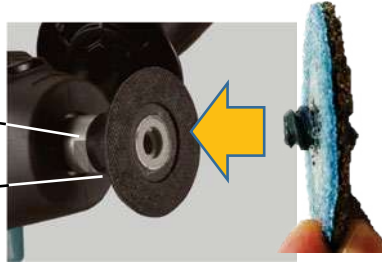

Surface conditioning disc
For Material: Metal / Stainless, Aluminum

Dia (mm)	Type	Application	Per Pkg.	Part No.	
50	Hard	<ul style="list-style-type: none"> • Surface polishing • Removing paint/rust 	Coarse	25	E-07462
			Medium	25	E-07478
			Fine	25	E-07484
	Soft	<ul style="list-style-type: none"> • Surface polishing 	Medium	25	E-07490
			Fine	25	E-07509
			Very fine	25	E-07515

Fiber sanding disc
For Material: Metal / Stainless, Aluminum

Dia (mm)	Grit	Application	Per Pkg.	Part No.
50	A60	<ul style="list-style-type: none"> • Grinding • Chamfering • Deburring • Surface polishing 	25	E-07412
	A80		25	E-07428
	A120		25	E-07434
	Z60	<ul style="list-style-type: none"> • Grinding • Chamfering • Deburring 	25	E-07440
	Z80		25	E-07456

Abrasive disc

(hook & loop type)



Dia (mm)	Grit	Per Pkg.	Part No.
----------	------	----------	----------

Pre-punched (8 hole) for Wood
For Model: BO5030, BO5031, BO5040, BO5041

Two-star range
★★

125	A40	10	D-54134
	A60	10	D-54140
	A80	10	D-54156
	A100	10	D-54162
	A120	10	D-54178
	A180	10	D-54190
	A240	10	D-54209
	A320	10	D-54215
	A60, A120, A240, A320	20 5pcs each	D-77229

Pre-punched (8 hole) for Paint
For Model: BO5030, BO5031, BO5040, BO5041
*Additional coat: Prevents clogging



Two-star range
★★

Dia (mm)	Grit	Per Pkg.	Part No.
125	*A40	10	D-65816
	*A60	10	D-65822
	*A80	10	D-65838
	*A100	10	D-65844
	*A120	10	D-65850
	*A150	10	D-65866
	*A180	10	D-65872
	*A240	10	D-65888
	*A320	10	D-65894
	*A400	10	D-65903

Pre-punched (9 hole) for Paint
For Model: BO6030, BO6040
*Additional coat: Prevents clogging

Three-star range
★★★

150	*WA60	10	794608-7
	*WA80	10	794609-5
	*WA120	10	794610-0
	*WA180	10	794611-8
	*WA240	10	794612-6
	*WA400	10	794613-4

Pre-punched (15 hole) for Wood
For Model: BO6030, BO6040, BO6050



Three-star range
★★★

150	A40	10	B-51415
	A60	10	B-51421
	A80	10	B-51437
	A100	10	B-51443
	A120	10	B-51459
	A180	10	B-51465
	A240	10	B-51471
	A320	10	B-51487
	A400	10	B-51493

Two-star range
★★

150	A40	10	D-54586
	A60	10	D-54592
	A80	10	D-54601
	A100	10	D-54617
	A120	10	D-54623
	A150	10	D-54639
	A180	10	D-54645
	A240	10	D-54651
	A320	10	D-54667

Coated Abrasive

Abrasive disc/ Drywall

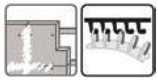

Three-star range
★★★



Dia (mm)	Grit	Per Pkg.	Part No.
225	*A40	25	B-68389
	*A80	25	B-68395
	*A120	25	B-68404
	*A150	25	E-02375
	*A180	25	B-68410
	*A320	25	B-68426

Abrasive Belt

For use with Belt Sander



Belt Size (mm)	Grit	Per Pkg.	Part No.
----------------	------	----------	----------

For Model: 9032, DBS180

Sanding arm Assembly

For Model: 9032

6mm: 125157-7, 9mm: 125158-5, 13mm: 125159-3

Three-star range
★★★

6 x 533	A40	10	A-34512
	A60	10	A-34528
	A80	10	A-34534
	A100	10	A-34540
	A120	10	A-34556
9 x 533	A40	10	A-34447
	A60	10	A-34453
	A80	10	A-34469
	A120	10	A-34481
13 x 533	A40	10	A-34562
	A60	10	A-34578
	A80	10	A-34584
	A100	10	A-34590
	A120	10	A-34609

For Model: 9031

Two-star range

★★

30x533	A40	5	D-67066 (P-36675)
	A60	5	D-67072
	A80	5	D-67088 (P-36697)
	A100	5	D-67094 (P-36706)
	A120	5	D-67103
	A150	5	D-67119
	A180	5	D-67131

For Model: 9902, 9903

Three-star range
★★★

76 x 533	WA40	10	794119-2
	WA60	10	794120-7
	WA80	10	794121-5
	WA100	10	794122-3
	WA120	10	794123-1
	WA150	10	794124-9
	WA180	10	794225-3
WA240	10	794125-7	

Two-star range
★★

76 x 533	A120	3	D-59302
----------	------	---	---------

For Model: 9920, 9924DB

Three-star range
★★★

76 x 610	WA150	10	794242-3
	WA180	10	794243-1
	WA240	10	794244-9

Two-star range
★★

76 x 610	A40	3	D-67147
	A60	3	D-67153
	A80	3	D-67169
	A100	3	D-67175
	A120	3	D-67181
	A150	3	D-67197
	A180	3	D-67206
A240	3	D-67212	

For Model: 9401, 9402, 9403, 9404

Three-star range
★★★

100 x 610	WA40	5	794133-8
	WA60	5	794134-6
	WA80	5	794135-4
	WA100	5	794136-2
	WA120	5	794137-0
	WA150	5	794138-8
	WA180	5	794222-9
	WA240	5	794139-6

Two-star range
★★

100 x 610	A40	3	D-59346
	A60	3	D-59352
	A80	3	D-59368
	A100	3	D-59374
	A120	3	D-59380
	A150	3	D-59396
	A180	3	D-59405
	A240	3	D-59411

Coated Abrasive

Wool pad/ Double side adapter



Model No.	Shank (mm)	Part No.
PV7001C, PV7000C, 9227C/B, 9237C/B, SA7000C	M14	D-56960



100mm Diamond polishing pad

(Hook & loop type)
8 pads assortment (1 each) D-15805

For Model:
PW5000C, PW5001C



Color	Grit	Part No.
Blue	50	D-15584
Yellow	100	D-15590
Orange	200	D-15609
Red	400	D-15615
Dark green	800	D-15621
Light green	1500	D-15637
Brown	3000	D-15643
Green	Buff (Finishing)	D-15659

Wool bonnet double side



Model No.	Disc Dia. (mm)	Type	Part No.
PV7001C, PV7000C, 9227C/B, 9237C/B, SA7000C	230	For Rough finishing	D-70873 (D-56954)
PV7001C, PV7000C, 9227C/B, 9237C/B, SA7000C	230	For Bright finishing	D-70889 (D-57146)

Wool bonnet



Model No.	Disc Dia. (mm)	Part No.
PV7001C, PV7000C, 9207SPB, 9218PB/L, 9227C/B	180	794176-0

Backing pad

(Hook & loop type)
(Use with Wool pad and Sleeve18 or Sponge pad)



Model	Spindle Thread	Part No.
9227C/B, PV7001C, PV7000C, SA7000C	M14 x 2 (DIN)	743053-3
	M16	743054-1

Coated Abrasive

Wool Pad

(hook & loop type)
(For high gloss polishing)

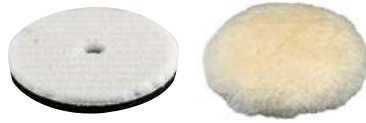

*When use 100mm size wool pad, use suitable pad for PO5000C

Model No.	Disc Dia. (mm)	Part No.
PV300D, PV301D	80	191N92-5
PO5000C	100	197918-5
PO5000C, DPO500	100	D-67000
PO5000C	125	197920-8
BO6030, BO6050, PO6000C, DPO600	150	D-65735
DBO180, DBO140, BO5031, BO5041	140	794560-9

(Use with Backing pad and Sleeve18)

9227C/B, 9237C/CB, PV7001/C, PV7000C	180	192629-7
--------------------------------------	-----	----------

Sponge type

Flat

Feature: Full contact surface
Use: Suitable for large, flat, panel



Wave

Feature: Air flow between the pad and the paint.
Use: Suitable for bumper made with resin.



Sponge pad (High repulsion)

(Hook & loop type)



Color & Application Coarse

Color: Orange
Use: Suitable for making wool bonnet sanding trace invisible



Medium

Color: Blue
Use: Suitable for finishing



Fine

Color: Black
Use: Suitable for Mirror finishing
applying wax, making polishing traces invisible



For Model:

DPO500, DPO600, PO5000C, PO6000C

*When use 100mm size sponge, use suitable pad for PO5000C

Type	Size	Application	Part No.
Flat	150mm	Coarse (Orange)	D-62527
		Medium (Blue)	D-62555
		Fine (Black)	D-62583
Wave	150mm	Coarse (Orange)	D-62614
		Medium (Blue)	D-62642
		Fine (Black)	D-62670

Felt Pad

(hook & loop type)
(For removing wax)



*When use 100mm size felt pad, use suitable pad for PO5000C

Model No.	Disc Dia. (mm)	Part No.
PO5000C	100	197916-9
DBO180, DBO140, BO5031, BO5041, BO6030, BO6050, DPO500, DPO600, PO6000C	125	196152-4
	150	193288-0

Sponge Pad

(Hook & loop type)



*When use 100mm size sponge, use suitable pad for PO5000C

Model No.	Disc Dia. (mm)	Part No.
PV300D, PV301D	80	191N90-9
PV300D, PV301D	80	191N91-7
DBO180, DBO140, BO5031, BO5041, DPO500, PO5000C	125	794558-6
(Use with Backing pad)		
9227C/CB, 9237C/CB, PV7001/C, PV7000C	190	193470-1

Rubber pad

Use with pre-punched abrasive disc.



Model No	Size	Type	Part No.
BO6050	150mm	Hard (For coarse sanding)	197315-5
	150mm	Soft (For general sanding)	197314-7
	150mm	Super Soft (For fine sanding)	197316-3
	130mm	Hard (For polishing)	197317-1
BO5030, BO5031, BO5040, BO5041	123mm	-	743081-8
DPO500, DPO600, PO5000C, PO6000C	100mm	-	197926-6
	125mm	-	197923-2
	150mm	-	197929-0

ACCESSORIES

Multi Tool



Hook and loop type



Precise



Blade thickness 2.0mm



Blade thickness 3.0mm

Multi-Tool

STARLOCK



Rating Suitability for application:

✓ = Suitable

Blank = No Rating

Color coding for application



Wood & Metal



Wood



Metal



Multi Material



Grout Abrasive

	Width (mm)	Teeth per inch	Blade Material	Curve Teeth
TMA045	85	18	BiM	
TMA046	100	15	BiM	
TMA047	32	20	BiM	●
TMA048	65	20	BiM	●
TMA057	10	20	BiM	
TMA058	20	20	BiM	
TMA049	85	18	HCS	
TMA050	24	18	HCS	
TMA051	32	18	HCS	●
TMA052	65	20	HCS	●
TMA053	32	14	BiM	●
TMA054	32	14	HCS	●
TMA055	65	14	BiM	●
TMA056	65	14	HCS	●
TMA059	32	20	BiM	
TMA060	20	23	TC	
TMA061	32	23	TC	
TMA079	45	23	TC	
TMA063	100	-	BiM	
TMA064	85	18	BiM	
TMA065	52	-	HCS	
TMA066	52	-	HCS	
TMA067	28	-	HCS	
TMA068	11	-	HCS	
TMA080	32	20	TC	●
TMA081	53	14	BiM	●
TMA082	12	-	Stainless	
TMA069	85	-	TC #30	
TMA070	85	-	Diamond	
TMA071	70	-	TC #50	
TMA072	85	-	TC #40	
TMA073	78	-	TC #20	
TMA074	70	-	TC #40	
TMA075	32	-	TC #50	
TMA076	32	-	TC #40	
TMA077	32	-	TC #100	
TMA083	90	-	TC #20	
TMA084	90	-	TC #40	
TMA085	90	-	TC #60	
TMA086	90	-	TC #100	

Wood & Metal

Wood					Metal				
Wood	Plywood	Chipboard	Laminate	Plaster board	Non ferrous metal	Sheet metal	Stainless	Soft nail	
✓	✓	✓	✓	✓	✓	✓			✓
✓	✓	✓	✓	✓	✓				✓
✓	✓	✓	✓	✓	✓	✓			✓
✓	✓	✓	✓	✓	✓	✓			✓
✓	✓	✓	✓	✓	✓	✓			✓
✓	✓	✓	✓	✓	✓	✓			✓
✓	✓	✓	✓						
✓	✓	✓	✓						
✓	✓	✓	✓	✓					
✓	✓	✓	✓	✓	✓	✓			✓
✓	✓	✓	✓	✓	✓	✓	✓		✓
✓	✓	✓	✓	✓	✓	✓	✓		✓
✓	✓	✓	✓	✓	✓	✓	✓		✓
✓	✓	✓	✓	✓	✓	✓			✓
✓									
✓									
✓	✓								
✓	✓								
✓		✓							
✓		✓							
✓		✓							
✓									



Multi Material						Grout Abrasive		
Epoxy	Fiber glass	Linoleum Carpet	Carpet adhesive	Insulation material	Soft joint material	Porous Concrete Soft brick	Soft wall tiles	Mortar Tile adhesive
✓	✓							
✓	✓							
✓	✓							
✓	✓							
✓	✓							
✓	✓							
✓								
✓								
✓	✓							
✓	✓							
✓	✓							
✓	✓							
✓	✓							
✓	✓							
		✓	✓	✓				
✓	✓		✓					
			✓					
			✓		✓			
✓	✓	✓	✓	✓				
✓					✓			
✓	✓					✓	✓	✓
✓	✓					✓	✓	✓
✓	✓					✓	✓	✓
✓	✓					✓	✓	✓
✓	✓					✓	✓	✓
✓	✓					✓	✓	✓
✓	✓					✓	✓	✓
✓	✓					✓	✓	✓
✓	✓					✓	✓	✓
✓	✓					✓	✓	✓
✓	✓					✓	✓	✓
	✓							✓
	✓							✓

Curve Teeth	Blade Material	Teeth per inch	Width (mm)	
	BiM	18	85	TMA045
	BiM	15	100	TMA046
●	BiM	20	32	TMA047
●	BiM	20	65	TMA048
	BiM	20	10	TMA057
	BiM	20	20	TMA058
	HCS	18	85	TMA049
	HCS	18	24	TMA050
●	HCS	18	32	TMA051
●	HCS	20	65	TMA052
●	BiM	14	32	TMA053
●	HCS	14	32	TMA054
●	BiM	14	65	TMA055
●	HCS	14	65	TMA056
	BiM	20	32	TMA059
	TC	23	20	TMA060
	TC	23	32	TMA061
	TC	23	45	TMA079
	BiM	-	100	TMA063
	BiM	18	85	TMA064
	HCS	-	52	TMA065
	HCS	-	52	TMA066
	HCS	-	28	TMA067
	HCS	-	11	TMA068
●	TC	20	32	TMA080
●	BiM	14	53	TMA081
	Stainless	-	12	TMA082
	TC #30	-	85	TMA069
	Diamond	-	85	TMA070
	TC #50	-	70	TMA071
	TC #40	-	85	TMA072
	TC #20	-	78	TMA073
	TC #40	-	70	TMA074
	TC #50	-	32	TMA075
	TC #40	-	32	TMA076
	TC #100	-	32	TMA077
	TC #20	-	90	TMA083
	TC #40	-	90	TMA084
	TC #60	-	90	TMA085
	TC #100	-	90	TMA086

Color coding for application



Wood & Metal



Wood



Metal



Multi Material



Grout Abrasive

Multi-Tool

STARLOCK PLUS

STARLOCK MAX



Rating Suitability for application:

✓ = Suitable
Blank = No Rating

Color coding for application

Width (mm)	Teeth per inch	Blade Material	Curve Teeth
------------	----------------	----------------	-------------

Wood & Metal									
Wood					Metal				
Wood	Plywood	Chipboard	Laminate	Plaster board	Non ferrous metal	Sheet metal	Stainless	Soft nail	

STARLOCK PLUS



Wood & Metal

MAP001	32	20	BiM	●
MAP002	65	20	BiM	●

✓	✓	✓	✓	✓	✓	✓			✓
✓	✓	✓	✓	✓	✓	✓			✓



Wood

MAP003	32	18	HCS	●
--------	----	----	-----	---

✓	✓	✓	✓						
---	---	---	---	--	--	--	--	--	--



Metal

MAP004	32	23	TC	
MAP005	45	23	TC	

✓	✓	✓	✓	✓	✓	✓	✓	✓	✓
✓	✓	✓	✓	✓	✓	✓	✓	✓	✓



Multi Material

MAP006	32	20	TC	●
MAP007	52	20	TC	●

✓	✓	✓	✓	✓	✓	✓	✓	✓	✓
✓	✓	✓	✓	✓	✓	✓	✓	✓	✓



Grout Abrasive

MAP008	53	-	TC #40	
--------	----	---	--------	--

✓		✓		✓	✓				✓
---	--	---	--	---	---	--	--	--	---

STARLOCK MAX



Wood & Metal

MAM001	32	20	BiM	●
MAM002	52	18	BiM	●
MAM003	100	15	BiM	

✓	✓	✓	✓	✓	✓	✓			✓
✓	✓	✓	✓	✓	✓	✓			✓
✓	✓	✓	✓		✓				✓



Wood

MAM004	32	18	HCS	●
--------	----	----	-----	---

✓	✓	✓	✓						
---	---	---	---	--	--	--	--	--	--



Metal

MAM005	32	23	TC	
--------	----	----	----	--

✓	✓	✓	✓	✓	✓	✓	✓	✓	✓
---	---	---	---	---	---	---	---	---	---



Multi Material

MAM006	32	20	TC	●
MAM007	32	-	HCS	
MAM008	32	-	HCS	

✓	✓	✓	✓	✓	✓	✓	✓	✓	✓



Grout Abrasive

MAM009	68	-	TC #50	
MAM010	68	-	TC #30	
MAM011	68	-	Diamond	
MAM012	68	-	Diamond	
MAM013	68	-	TC #40	
MAM014	100	-	TC #40	
MAM015	116	-	TC #20	
MAM016	116	-	TC #40	
MAM017	116	-	TC #60	
MAM018	116	-	TC #100	

				✓					
				✓					
				✓					
				✓					
				✓					
✓	✓			✓	✓				✓
✓	✓	✓							
✓	✓	✓							
✓	✓	✓							
✓	✓	✓							



Multi Material						Grout Abrasive		
Epoxy	Fiber glass	Linoleum Carpet	Carpet adhesive	Insulation material	Soft joint material	Porous Concrete Soft brick	Soft wall tiles	Mortar Tile adhesive

Curve Teeth	Blade Material	Teeth per inch	Width (mm)
-------------	----------------	----------------	------------

Color coding for application

✓	✓							
✓	✓							

●	BiM	20	32	MAP001
●	BiM	20	65	MAP002

Wood & Metal 

✓								
---	--	--	--	--	--	--	--	--

●	HCS	18	32	MAP003
---	-----	----	----	--------

Wood 

✓	✓					✓		
✓	✓							

	TC	23	32	MAP004
	TC	23	45	MAP005

Metal 

✓	✓					✓		
✓	✓					✓		

●	TC	20	32	MAP006
●	TC	20	52	MAP007

Multi Material 

✓						✓		
---	--	--	--	--	--	---	--	--

	TC #40	-	53	MAP008
--	--------	---	----	--------

Grout Abrasive 

✓	✓							
✓	✓							
✓								

●	BiM	20	32	MAM001
●	BiM	18	52	MAM002
	BiM	15	100	MAM003

Wood & Metal 

--	--	--	--	--	--	--	--	--

●	HCS	18	32	MAM004
---	-----	----	----	--------

Wood 

✓	✓					✓		
---	---	--	--	--	--	---	--	--

	TC	23	32	MAM005
--	----	----	----	--------

Metal 

✓	✓					✓		
					✓			
				✓	✓			

●	TC	20	32	MAM006
	HCS	-	32	MAM007
	HCS	-	32	MAM008

Multi Material 

✓	✓					✓	✓	✓
✓	✓					✓	✓	✓
✓	✓					✓	✓	✓
✓	✓					✓	✓	✓
✓	✓					✓	✓	✓
✓	✓					✓		✓
	✓							✓
	✓							✓

	TC #50	-	68	MAM009
	TC #30	-	68	MAM010
	Diamond	-	68	MAM011
	Diamond	-	68	MAM012
	TC #40	-	68	MAM013
	TC #40	-	100	MAM014
	TC #20	-	116	MAM015
	TC #40	-	116	MAM016
	TC #60	-	116	MAM017
	TC #100	-	116	MAM018

Grout Abrasive 

Multi-Tool

Segment saw blade 85

TMA045



Feature : Suitable for Flush cutting
Another material : Epoxy, Fiberglass

Diameter (mm)	Type	Per pkg.	Part No.
85	BiM, Wood&Metal	1	B-64799

Segment saw blade 100

TMA046



Feature : Suitable for Deep cutting
Another material : Epoxy, Fiberglass

Diameter (mm)	Type	Per pkg.	Part No.
100	BiM, Wood&Metal	1	B-64808

Bow Shape plunge cut saw blade 32

TMA047



Feature : Suitable for Precisely plunge cut
Another material : Epoxy, Fiberglass

Size (mm)	Type	Per pkg.	Part No.
32 x 50	BiM, Wood&Metal	1	B-64814

Bow Shape plunge cut saw blade 65

TMA048



Feature : Suitable for Precisely plunge cut
Another material : Epoxy, Fiberglass

Size (mm)	Type	Per pkg.	Part No.
65 x 40	BiM, Wood&Metal	1	B-64820

Plunge cut saw blade 10

TMA057



Feature : Suitable for Flush cutting in nails or Plasterboard
Another material : Epoxy, Fiberglass

Size (mm)	Type	Per pkg.	Part No.
10 x 30	BiM, Wood&Metal	1	B-64917

Plunge cut saw blade 20

TMA058



Feature : Suitable for Flush cutting in nails or copper pipe
Another material : Epoxy, Fiberglass

Size (mm)	Type	Per pkg.	Part No.
20 x 30	BiM, Wood&Metal	1	B-64923

Especially suitable for Wood



Segment saw blade 85

TMA049



Feature : Suitable for Flush cutting
Another material : Epoxy

Size (mm)	Type	Per pkg.	Part No.
85	HCS, Wood	1	B-64836

Plunge cut saw blade 24

TMA050



Feature : Suitable for Plunge cut
Another material : Epoxy

Size (mm)	Type	Per pkg.	Part No.
24 x 50	HCS, Wood	1	B-64836
24 x 50	HCS, Wood	1	B-64842

Bow Shape plunge cut saw blade 32q

TMA051



Feature : Suitable for Precisely plunge cut
Another material : None

Size (mm)	Type	Per pkg.	Part No.
32 x 50	HCS, Wood	1	B-64858

Multi-Tool

Bow Shape plunge cut saw blade 65

TMA052



Feature : Suitable for Precisely plunge cut
Another material : Epoxy

Size (mm)	Type	Per pkg.	Part No.
65 x 40	HCS, Wood	1	B-64864

Bow Shape plunge cut saw blade 32

TMA053



Feature : Suitable for Precisely plunge cut
Another material : Epoxy, Fiberglass

Diameter (mm)	Type	Per pkg.	Part No.
32 x 50	BiM, Wood	1	B-64870

Bow Shape plunge cut saw blade 32

TMA054



Feature : Suitable for Precisely plunge cut
Another material : None

Diameter (mm)	Type	Per pkg.	Part No.
32 x 50	HCS, Wood	1	B-64886

Bow Shape plunge cut saw blade 65

TMA055



Feature : Suitable for Precisely plunge cut
Another material : Epoxy, Fiberglass

Diameter (mm)	Type	Per pkg.	Part No.
65 x 40	BiM, Wood	1	B-64892

Bow Shape plunge cut saw blade 65

TMA056



Feature : Suitable for Precisely plunge cut
Another material : None

Diameter (mm)	Type	Per pkg.	Part No.
65 x 40	HCS, Wood	1	B-64901

Especially suitable for Metal



Plunge cut saw blade 32

TMA059



Feature : Suitable for Flush cutting in nails or copper pipe
Another material : Wooden material, Plasterboard, Epoxy, Fiberglass

Diameter (mm)	Type	Per pkg.	Part No.
32 x 50	BiM, Metal	1	B-64939

TC Bar plunge cut saw blade 20

TMA060



Feature : Suitable for Flush cutting in hardened screws and nails
Another material : Wooden material, Plasterboard, Epoxy, Fiberglass

Diameter (mm)	Type	Per pkg.	Part No.
20 x 40	TC/HM, Metal	1	B-64945

TC Bar plunge cut saw blade 32

TMA061



Feature : Suitable for Flush cutting in hardened screws and nails
Another material : Wooden material, Plasterboard, Epoxy, Fiberglass

Diameter (mm)	Type	Per pkg.	Part No.
32 x 40	TC/HM, Metal	1	B-64951

TC Bar plunge cut saw blade 45

TMA079



Feature : Suitable for Flush cutting in hardened screws and nails
Another material : Wooden material, Plasterboard, Epoxy, Fiberglass

Diameter (mm)	Type	Per pkg.	Part No.
45 x 40	TC/HM, Metal	1	B-69755

Multi-Tool

Especially suitable for Multi material



Serrated Seg Blade 100

TMA063



Feature : Suitable for Insulation material
Another material : None

Diameter (mm)	Type	Per pkg.	Part No.
100	BiM, Multi Material	1	B-64967

Segment saw blade 85

TMA064



Feature: Suitable for Plunge cut in plasterboard
Another material : Wooden material, Nonferrous metal, Sheet metal, softnails

Diameter (mm)	Type	Per pkg.	Part No.
85	BiM-TIN, Multi Material	1	B-64973

Scraper 52 Rigid

TMA065



Feature : Suitable for Removing mortar or tile adhesive
Another material : None

Size(mm)	Type	Per pkg.	Part No.
52 x 26	HCS, Multi Material	1	B-64989

Scraper 52 Flexible

TMA066



Feature: Suitable for Removing soft carpet adhesive residues or silicone joints
Another material : None

Size(mm)	Type	Per pkg.	Part No.
52 x 40	HCS, Multi Material	1	B-64995

General Joint Cutter

TMA067



Feature : Suitable for Soft joint material cut
Another material : None

Size(mm)	Type	Per pkg.	Part No.
28 x 40	HCS, Multi Material	1	B-65006

Universal purpose knife

TMA068



Application/ Recommended Use
Cutting insulation materials
Cutting window putty.
Cutting expansion joints

Size(mm)	Type	Per pkg.	Part No.
11 x 24	HCS	1	B-65012

TC Bar Bow Shape plunge cut saw blade 32

TMA080



Application/ Recommended Use
Multi material/ Suitable for precisely plunge cut
Plunge cut plasterboard, fiberglass, epoxy, aluminum, stainless

Size(mm)	Type	Per pkg.	Part No.
32 x 40	TC/HM, Multi Material	1	B-69761

Bow Shape plunge cut saw blade 53

TMA081



Feature : Suitable for Precisely and fast plunge cut in plasterboard
Another material : Wood, Chipboard
1 Blade does the job of 2 (plunge & cut on)

Size(mm)	Type	Per pkg.	Part No.
53 x 40	BiM, Multi Material	1	B-69777

Universal purpose knife

TMA082



Feature : Suitable for Cutting in taeksealant, caulking material
Another material : None

Size(mm)	Type	Per pkg.	Part No.
12 x 29	Stainless, Multi Material	1	B-69783



Multi-Tool

Especially suitable for Grout Abrasive



TC Seg Saw Blade 85

TMA069



Feature : Suitable for Routing joints on wall and floor tiles
Another material : Epoxy, Fiberglass, Plasterboard

Diameter (mm)	Type	Per pkg.	Part No.
85	TC/HM grit #30	1	B-65028

Diamond Seg Saw blade 85

TMA070



Feature : Suitable for Cut out of wall tiles
Another material : Plasterboard, Epoxy, Fiberglass

Diameter (mm)	Type	Per pkg.	Part No.
85	Diamond grit #40	1	B-65034

TC Seg Saw Blade 70

TMA071



Feature: Suitable for Routing thin joints on wall tiles
Another material : Plasterboard, Epoxy, Fiberglass

Diameter (mm)	Type	Per pkg.	Part No.
70	TC/HM grit #50	1	B-65040

TC Seg Saw Blade 85

TMA072



Feature : Suitable for Routing joints on wall tiles
Another material : Plasterboard, Epoxy, Fiberglass

Diameter (mm)	Type	Per pkg.	Part No.
85	TC/HM grit #40	1	B-65056

TC Sanding Plate 78

TMA073

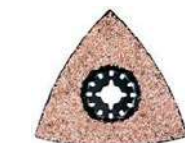

Feature : Suitable for Routing mortar or tile adhesive
Another material : Wood, Epoxy

Size(mm)	Type	Per pkg.	Part No.
78	TC/HM grit #20	1	B-65062

TC Remover

TMA074



Feature : Suitable for Routing joints on wall and floor tiles
Another material : Plasterboard, Epoxy, Fiberglass

Size(mm)	Type	Per pkg.	Part No.
70	TC/HM grit #40	1	B-65078

TC Plunge Blade 32

TMA075



Feature : Suitable for Removing grouts in narrow corner or tide spaces
Another material : Wood, Plasterboard, Epoxy, Fiberglass

Size(mm)	Type	Per pkg.	Part No.
32 x 30	TC/HM grit #50	1	B-65084

TC Sanding Pointer 32

TMA076



Feature : Suitable for Sanding paint in tight gap
Another material : Wood

Diameter (mm)	Type	Per pkg.	Part No.
32 x 50	TC/HM grit #40	1	B-65090



TC Sanding Pointer 32

TMA076



Feature : Suitable for Sanding paint in tight gap
Another material : Wood

Diameter (mm)	Type	Per pkg.	Part No.
32 x 50	TC/HM grit #100	1	B-65109

Multi-Tool

Sanding pad

TMA078



Size(mm)	Type	Per pkg.	Part No.
93	hook & loop	1	B-65115

TC Sanding Plate 90

TMA083



Feature : Suitable for Routing mortar, tile adhesive, paint on fiberglass
Another material : Wooden material, Fiberglass

Size(mm)	Type	Per pkg.	Part No.
90	TC/HM grit #20	1	B-69799

TC Sanding Plate 90

TMA084



Feature : Suitable for Sanding in wood with paint, paint of fiberglass
Another material : Wooden material, Fiberglass

Size(mm)	Type	Per pkg.	Part No.
90	TC/HM grit #40	1	B-69808

TC Sanding Plate 90

TMA085



Feature : Suitable for Sanding Wood
Another material : Wood

Size(mm)	Type	Per pkg.	Part No.
90	TC/HM grit #60	1	B-69814

TC Sanding Plate 90

TMA086



Feature : Suitable for Sanding Wood
Another material : Wood

Size(mm)	Type	Per pkg.	Part No.
90	TC/HM grit #100	1	B-69820

Multi tool Starlock blade sets (with Tool box)

The components of each set are packed in tool box complete.
Tool box can insert to the plastic case of TM3010C, DTM51 and DTM41.



Set Contents	Part No.
TMA045, TMA047, TMA053, TMA058, TMA078	199542-0

Multi tool Starlock blade sets

Tile Set

TMA058 Plunge cut saw blade 20
TMA065 Scraper 52 rigid
TMA069 HM Seg saw blade 85
TMA073 HM Sanding plate 78



Part No.

B-67496

Floor Set

TMA045 Segment saw blade 85
TMA048 Plunge cut saw blade 65
TMA051 Plunge cut saw blade 32
TMA066 Scraper 52 Flexible



Part No.

B-67505

Plunge Cut Set

TMA045 Segment saw blade 85
TMA047 Plunge cut saw blade 32
TMA053 Bow plunge cut saw blade 32
TMA058 Plunge cut saw blade 20



Part No.

B-67480

Carpentry Set

TMA045 Segment saw blade 85
TMA047 Plunge cut saw blade 32
TMA053 Bow plunge cut saw blade 32
Sanding Pad x 2pcs



Part No.

B-67511

Carpentry Set

TMA006 Segment saw blade 85
TMA009 Plunge cut saw blade 28
TMA010 Plung cut saw blade 32
Sanding Pad x 2pcs



Part No.

B-30639

Multi-Tool

Abrasive delta paper/ Stone



Paper Size(mm)	Grit	Per pkg.	Part No.
94	120	10	B-21749
94	240	10	B-21755
94	400	10	B-21761
94	600	10	B-21777
94	1200	10	B-21783
94	120,240, 400, 600,1200	10 (2pcs/each)	B-21733

Abrasive delta paper/ Polishing fleece

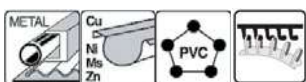

Paper Size(mm)	Grit	Per pkg.	Part No.
94	Coarse / 100	1	B-21808
94	Medium / 280	1	B-21799
94	without grit	1	B-21814

Abrasive delta paper/ Polishing felt



Paper Size(mm)	Grit	Per pkg.	Part No.
94	Hard	1	B-21820



Abrasive delta paper/ Wood/ long-life



Paper Size(mm)	Grit	Per pkg.	Part No.
94	60	10	B-21565
94	80	10	B-21571
94	100	10	B-21587
94	120	10	B-21593
94	180	10	B-21602
94	240	10	B-22931

Abrasive delta paper/ Wood



Paper Size(mm)	Grit	Per pkg.	Part No.
94	60	10	B-21624
94	80	10	B-21630
94	100	10	B-22947
94	120	10	B-21646
94	150	10	B-22953
94	180	10	B-21652
94	240	10	B-21668
94	60,80,120,180,240	10 (2pcs/each)	B-21618

Abrasive delta paper/ Wood/ economy type



Paper Size(mm)	Grit	Per pkg.	Part No.
94	40	10	D-58578
94	60	10	D-58584
94	80	10	D-58590
94	100	10	D-58609
94	120	10	D-58615
94	150	10	D-58621
94	180	10	D-58637
94	240	10	D-58643
94	320	10	D-58659

Abrasive delta paper/ Paint



Paper Size(mm)	Grit	Per pkg.	Part No.
94	60	10	B-21680
94	100	10	B-21705
94	120	10	B-22969
94	240	10	B-21711
94	320	10	B-21727
94	60,80,100,240,320	10 (2pcs/each)	B-21674

Abrasive delta paper (Page 125) applications



Rating Suitability for application

AA: Recommended
 A: Acceptable
 n.r.: No Rating

Product Application and Rating On Each Material		Grit	Paint	Varnish	Filler	Roughcast	Wood / Wooden materials	soft wood	hard wood	Plywood	Chipboard/MDF	Metal	Steel (mild steel / carbon steel)	Stone	Marble	Granite	Glass	Perspex	Corian®	Glass fiber reinforced	
Wood / long-life	Coarse	60	n.r.	n.r.	n.r.	n.r.	AA	AA	AA	AA	AA	AA	A	n.r.	n.r.	n.r.	n.r.	n.r.	n.r.	n.r.	n.r.
		80																			
		100																			
	Medium	120																			
		180																			
		240																			
Wood (★★★)	Coarse	60	n.r.	n.r.	n.r.	n.r.	AA	A	AA	AA	AA	n.r.	n.r.	n.r.	n.r.	n.r.	n.r.	n.r.	n.r.	n.r.	n.r.
		80																			
		100																			
	Medium	120																			
		150																			
		180																			
Wood (★★)	Coarse	40	A	A	n.r.	n.r.	AA	AA	AA	AA	A	A	A	n.r.	n.r.	n.r.	n.r.	n.r.	n.r.	n.r.	n.r.
		60																			
		80																			
	Medium	100																			
		120																			
		150																			
Fine	180																				
	240																				
	320																				
Paint	Coarse	60	AA	AA	AA	AA	n.r.	n.r.	A	n.r.	n.r.	A	A	n.r.	n.r.	n.r.	n.r.	n.r.	n.r.	n.r.	n.r.
		80																			
		100																			
	Medium	120																			
		240																			
		320																			
Stone	Medium	120	A	AA	n.r.	n.r.	n.r.	n.r.	n.r.	n.r.	n.r.	n.r.	A	A	A	A	A	A	A	A	
		240																			
		400																			
	Fine	600																			
		Very fine																			1200



ACCESSORIES

▣ Diamond



Wet



Hook and loop type

Diamond

Diamond Wheels



Segmented Type:

Most commonly used. Blade has slits and layers of diamond are sintered on edges. Cut faster than continuous rim type and attain average cutting surface.



Segmented Wave Type:

This wheel has slits like segmented wheel. Each segment has many notches (Wave). These notches assure;

- Fast cutting with less resistance.
- Smooth debris removal.
- Less loading on wheel.



Corrugated Type:

This wheel has notches around the Rim. Has a characteristic between Continuous Rim and Segmented Type. Has faster cutting like Segmented Type. At the same time, can attain cleaner surface like continuous rim without broken edges.



Continuous Rim Type:

Has layer of diamond with uniform thickness around the entire rim. Can attain clean surface even on crusty, brittle materials. Cut with accuracy but not as fast as segmented type wheel.

SPECIALIZED



Electrodeposited Type:

Diamonds are electrodeposited and has more exposure than bonded type. Cuts faster and more efficient.



Vacuum brazed Type:

Diamonds are vacuum brazed and has more exposure than bonded type. Able to cut harder material. It is longer life than electrodeposited type because diamonds are held tightly.



Crack Chaser:

Blade is thicker than regular blades. Designed for repair the wall easily.

Diamond

Diamond Wheel

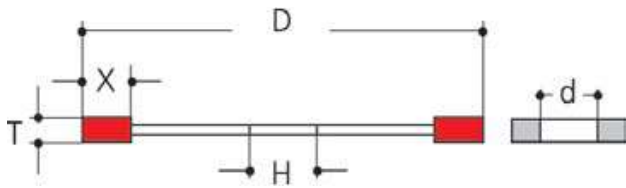

(EN) : EN13236

AA: Specially suitable, A: Suitable

Ring

(10 pcs. /set)
(mm)

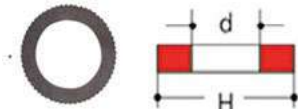

Description	(H) Outer Dia	(D) Hole Dia	Part No.
Ring 20	22.23	20	A-85248
Ring 16	20	16	A-86860



Material

Material No.1						
Hard concrete	Granite	Gneiss	Smoothable Engineering	Carbonaceous Shale	Sidewalk Slate	Engineering Block/ Engineering Block Class 2

Material No.2				Material No.3		
Concrete	Block	U-shaped Groove	Sidewalk Block	Cemented Tile	Marble	Unglazed Tile

Material No.4			Material No.5	Material No.6	Material No.7
Brick	Aggregate Block	French Tile	Asphalt	Tile	Glass

Diamond

Diamond Wheel for Concrete



X-Lock

Four-star range

★★★★

<Ideal for Concrete / Dry>



XLOCK

Shape	D	T	X	H	d	Color	For Material							Model No.	Part No.
							1	2	3	4	5	6	7		
	100	1.6	7	X-Lock	-	Blue	AA	AA	AA	A	-	-	-	X-LOCK 100mm Grinder	E-02054(EN)
	115	1.6	7	X-Lock	-	Blue	AA	AA	AA	A	-	-	-	X-LOCK 115mm Grinder	E-02060(EN)
	125	1.6	7	X-Lock	-	Blue	AA	AA	AA	A	-	-	-	X-LOCK 125mm Grinder	E-02076(EN)

Segmented

Four-star range

★★★★

<Ideal for Concrete / Dry>



Shape	D	T	X	H	d	Color	For Material							Model No.	Part No.
							1	2	3	4	5	6	7		
	230	2.4	15	22.23	-	Blue	AA	AA	AA	A	-	-	-	230mm DC Power cutter	E-02967(EN)
	355	2.8	10	25.4	-	Blue	AA	AA	AA	A	-	-	-	355mm DC Power cutter, 355mm Engine power cutter	E-12996(EN)

1. Ideal for cordless tools

2. Thin blade & Light weight

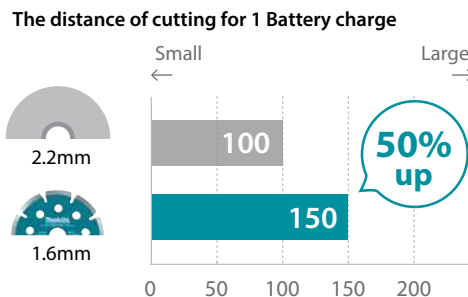

Note:

The test results depend to a great extent on the hardness of materials, etc.
The numbers in the bar graphs are relative values when the capacity of Makita Diamond Wheel (Thickness:2.2mm) is indexed at 100.



This blade is designed as 1.6mm (the basis is 1.1mm). So smooth and light cutting is available.

It was lightened by punching the body. (eg:ø125mm blade is 95g [current blade : 125g]) It is also reduced the load on the battery and increased the cutting distance per 1 battery charge.

<Ideal for Concrete / Dry>

Shape	D	T	X	H	d	Color	For Material							Model No.	Part No.
							1	2	3	4	5	6	7		
	105	1.8	7.5	20	16	Gold	-	AA	AA	A	-	-	-	100mm Grinder, 110mm Cutter	A-87149
	110	1.8	6	20	-	Gold	-	AA	AA	A	A	-	-	110mm Cutter	A-05022
	230	2.2	7.5	22.23	-	Gold	-	AA	AA	A	-	-	-	230mm Grinder	D-44292

Diamond

Two-star range



<Ideal for Concrete / Dry>

Shape	D	T	X	H	d	Color	For Material							Model No.	Part No.
							1	2	3	4	5	6	7		
	180	2.3	7	25.4	22.23	Gold	-	AA	AA	A	A	-	-	180mm Grinder, 180mm Cutter	A-84121(EN)

Long Life

<Ideal for Concrete / Dry>

	105	2	7	20	16	Gold	-	AA	AA	A	A	-	-	100mm Grinder, 110mm Cutter	D-05197
	125	2.2	7	20	-	Gold	-	AA	AA	A	-	-	-	125mm Cutter	D-38261

One-star range



<Ideal for Concrete / Dry>

	105	2	7	20	16	Gold	A	AA	A	A	-	-	-	100mm Grinder, 110mm Cutter	D-42531
	125	2.2	7	22.23	-	Gold	A	AA	A	A	A	-	-	115mm Grinder	D-44270
	180	2.4	7	22.23	-	Gold	A	AA	A	A	-	-	-	180mm Grinder	D-44286
	230	2.6	7	22.23	-	Gold	A	AA	A	A	-	-	-	230mm Grinder	D-44292

<Ideal for Concrete / Dry>

	105	2.2	9	20	16	Gold	-	AA	-	-	-	-	-	100mm Grinder, 110mm Cutter	D-71009
	125	2.2	9	22.23	20	Gold	-	AA	-	-	-	-	-	125mm Grinder, 125mm Cutter	D-71021

Corrugated

Three-star range



<Ideal for Concrete / Dry>

Shape	D	T	X	H	d	Color	For Material							Model No.	Part No.
							1	2	3	4	5	6	7		
	125	2.1	7	22.23	20	Gold	-	AA	AA	A	A	-	-	125mm Grinder, 125mm Cutter	A-84159(EN)
	230	2.6	7	22.23	-	Gold	-	AA	AA	A	A	-	-	230mm Grinder	A-84171(EN)

Long Life

<Ideal for Concrete / Dry>

	105	2	7	20	16	Gold	-	AA	AA	A	-	-	-	100mm Grinder, 110mm Cutter	D-05206
---	-----	---	---	----	----	------	---	----	----	---	---	---	---	-----------------------------	---------

Diamond

Segmented wave

Three-star range

★★★

<Ideal for Concrete / Dry>

Shape	D	T	X	H	d	Color	For Material							Model No.	Part No.
							1	2	3	4	5	6	7		
	125	2	7.5	22.23	-	Blue	-	AA	AA	A	A	-	-	125mm Grinder	A-80438(EN)

<Concrete & Granite / Dry>

	180	2.2	8	22.23	-	Gold	AA	AA	AA	A	A	-	-	180mm Grinder	B-02060
---	-----	-----	---	-------	---	------	----	----	----	---	---	---	---	---------------	---------

One-star range

★

<Ideal for Concrete, Granite/ Dry>

	115	2	7	22.23	-	Blue	AA	AA	A	A	-	-	-	115mm Grinder	D-41420
	180	2.6	7	22.23	-	Blue	AA	AA	A	A	-	-	-	180mm Grinder	D-44339
	230	2.8	7	22.23	-	Blue	AA	AA	A	A	-	-	-	230mm Grinder	D-44345

Continuous rim

Three-star range

★★★

<Ideal for Tile, Concrete & Brick / Wet>



Shape	D	T	X	H	d	Color	For Material							Model No.	Part No.
							1	2	3	4	5	6	7		
	76	1.6	5	20	-	Violet						AA		76mm Cutter	D-74790
	110	1.6	5	20	-	Gold	-	AA	AA	A	-	A	-	110mm Cutter	D-05212
	110	1.5	4	20	-	Gold	A	AA	AA	A	A	AA	-	110mm Cutter	A-07185



Diamond

Diamond Wheel for Stone



Segmented wave

Three-star range



<Ideal for Granite / Dry>

Shape	D	T	X	H	d	Color	For Material							Model No.	Part No.
							1	2	3	4	5	6	7		
	125	2	7.5	20	-	Gold	AA	AA	AA	AA	A	-	-	4105KB	792282-5

Two-star range



<Ideal for Granite / Dry>

	105	1.7	7	20	16	Silver	AA	AA	AA	A	A	-	-	100mm Grinder, 110mm Cutter	A-84090
	125	2	7	22.23	20	Silver	AA	AA	AA	A	A	-	-	125mm Grinder, 125mm Cutter	A-84012
	180	2	6	25.4	22.23	Silver	AA	AA	AA	A	A	-	-	180mm Grinder, 180mm Cutter	A-84028

One-star range



<Ideal for Granite, Marble / Dry>



	105	2.2	7	20/16	16	Silver	AA	-	-	-	-	-	-	100mm Grinder, 110mm Cutter	D-41399
	105	2.2	7	20/16	16	Green	-	-	AA	-	-	-	-	100mm Grinder, 110mm Cutter	D-41408

Corrugated

Two-star range



<Ideal for Granite / Dry>

	105	2	7	20	16	Silver	AA	AA	AA	A	A	-	-	100mm Grinder, 110mm Cutter	A-84040(EN)
--	-----	---	---	----	----	--------	----	----	----	---	---	---	---	-----------------------------	-------------

Two-star range



<Ideal for Ceramic and porcelain/ Wet&Dry>

	105	1.2	7	20	16	Violet	-	-	-	-	-	AA	-	100mm Grinder, 110mm Cutter	D-77198
--	-----	-----	---	----	----	--------	---	---	---	---	---	----	---	-----------------------------	---------

One-star range



<Ideal for Granite, Marble / Dry>

	105	2.2	7	20	16	Silver	AA	A	AA	A	-	-	-	100mm Grinder, 110mm Cutter	D-42553
--	-----	-----	---	----	----	--------	----	---	----	---	---	---	---	-----------------------------	---------

Diamond

Diamond Wheel for Tile



Corrugated

Four-star range
★★★★



1. Ideal for cordless tools

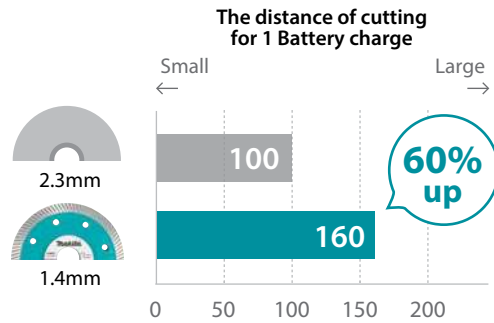

2. Thinner blade

With the bare necessities of thickness which able to have enough strength, able to get smooth and light cutting.

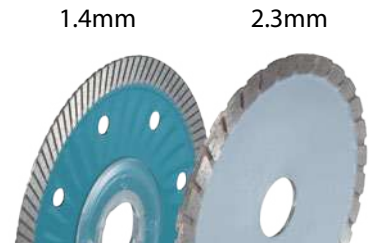

Note:

The test results depend to a great extent on the hardness of materials, etc. The numbers in the bar graphs are relative values when the capacity of Makita Diamond Wheel (Thickness:2.3mm) is indexed at 100.

<Ideal for Porcelain Tile / Dry>
Thin type

Shape	D	T	X	H	d	Color	For Material							Model No.	Part No.
							1	2	3	4	5	6	7		
	105	1.4	10	22.23	16	Blue	-	A	A	AA	-	AA	-	100mm Grinder	B-49030(EN)

Continuous rim

Three-star range
★★★

<Wet>



	110	1.5	4	20	-	Gold	A	AA	AA	A	A	AA	-	110mm Cutter	A-81131
--	-----	-----	---	----	---	------	---	----	----	---	---	----	---	--------------	---------

Diamond Wheel for Glass



Corrugated

Three-star range
★★★

<Ideal for Bulletproof Glass / Wet>

	110	1.2	6	20	-	Blue	-	-	AA	A	A	AA	AA	110mm Cutter	B-00795
--	-----	-----	---	----	---	------	---	---	----	---	---	----	----	--------------	---------

Diamond

Specialized / Vacuum brazed Diamond Wheel

1. Cut various material



The diamond abrasive grain are adhered on wheel surface directly which is different from the regular wheel containing diamond abrasive grain buried on layers .

2. Less spark

Diamond wheel



Abrasive Cut off wheel



The major general contractor dislike sparks at the work site, so you can recommend this blade to these work site.



Multi cut
(Dry)

Shape	D	T	X	H	d	Color	For Material							Model No.	Part No.
							1	2	3	4	5	6	7		
	110	2	5.0	20	16	Violet	A	A	A	A	-	-	-	100mm Grinder, 110mm Cutter	D-44426
	125	2.8	4.0	22.23	-	Red	A	A	A	A	A	A	A	125mm Grinder	B-55310(EN)
	230	3.1	4.0	22.23	-	Red	A	A	A	A	A	A	A	230mm Grinder	B-55326(EN)
	300	3.4	4.0	25.4	20	Red	A	A	A	A	A	A	A	305mm Power Cutter	B-55332(EN)

For Metal

	100	1.3	1.5	16	-	Violet	-	-	-	-	-	-	-	100mm Grinder	B-53671(EN)
	125	1.3	1.5	22.23	-	Violet	-	-	-	-	-	-	-	125mm Grinder	B-53693(EN)
	180	1.3	1.5	22.23	-	Violet	-	-	-	-	-	-	-	180mm Grinder	B-53702(EN)

Specialized / Tungsten Carbide Grit Blade

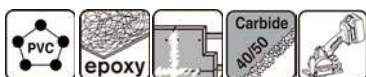

Shape	D	T	X	H	d	Color	For Material							Model No.	Part No.
							1	2	3	4	5	6	7		
PVC / Plaster board / Epoxy	76	-	-	10	-	Blue	-	-	-	-	-	-	-	DMC300	D-74837

Diamond

Specialized / Cordless Cutter



Shape	D	T	X	H	d	Color	For Material							Model No.	Part No.
							1	2	3	4	5	6	7		
High Grade / Continuous rim / Wet	80	0.8	4.0	15	-	Silver	-	-	-	-	-	AA	AA	4190DW, 4191DW	792296-4
Standard / Electrodeposited / Glass & Porcelain / Wet	85	0.8	2.2	15	-	Silver	-	-	AA	-	-	AA	AA	CC300D, 4190DW, 4191DW	A-07179

Specialized / Engine Power Cutter Tools

Laser Welded



Shape	D	T	X	H	d	Color	For Material							Model No.	Part No.
							1	2	3	4	5	6	7		
Standard / Segmented / Concrete, Brick	300	2.8	7.5	25.4	20	Gold	A	AA	A	AA	-	-	-	305mm Power Cutter	D-56982(EN)
Standard / Segmented / General	350	3.2	5	25.4	20	Silver	A	AA	AA	AA	-	-	-	355mm Power Cutter	A-87317
Standard / Segmented / Concrete, Brick	350	2.8	7.5	25.4	20	Gold	A	AA	A	AA	-	-	-	355mm Power Cutter	D-56998(EN)
Standard / Segmented / Concrete, Brick	400	3	7.5	25.4	20	Gold	A	AA	A	AA	-	-	-	405mm Power Cutter	D-57009(EN)

Specialized / 305mm Cutter, Engine Power Cutter Tools



Shape	D	T	X	H	d	Color	For Material							Model No.	Part No.
							1	2	3	4	5	6	7		
Standard / Segmented / Asphalt / Dry	305	3	7.5	30	20, 22.23, 25.4	Silver	-	-	-	-	A	-	-	305mm Cutter, Power Cutter	A-02484
Standard / Segmented / Concrete & Asphalt / Dry	305	3	7.5	30	20, 22.23, 25.4	Blue	-	AA	AA	AA	A	-	-	305mm Cutter, Power Cutter	A-02490

Specialized / 355mm Portable Cut-off Tools



Shape	D	T	X	H	d	Color	For Material							Model No.	Part No.
							1	2	3	4	5	6	7		
Vacuum brazed / Metal	355	3.3	4	25.4	-	Violet	-	-	-	-	-	-	-	355mm Portable Cut-off	D-41414







Specialized / Wall Chaser Tools





Shape	D	T	X	H	d	Color	For Material							Model No.	Part No.
							1	2	3	4	5	6	7		
Segmented / Dry	125	2	7.5	22.23	-	Blue	-	AA	AA	A	A	-	-	SG1251	A-80438(EN)
Segmented / Dry	155	2	7	22.23	-	Blue	-	AA	AA	A	A	-	-	SG150	A-83836

Diamond



Offset Diamond Wheels

<p>Single</p> 	<p>Rough work</p> <p>This wheel grind more efficiency. Faster than the wheel for standard work.</p>
<p>Double</p>  <p>Segmented</p>  <p>Fan</p> 	<p>Standard work</p> <p>This wheel has a characteristic between Rough work offset diamond wheels and Fine work offset diamond wheels.</p>
<p>Turbo</p>  <p>Rim</p> 	<p>Fine work</p> <p>This wheel is suitable for cleanup and finish work and chamfering works.</p>

SPECIALIZED

<p>PCD</p> 	<p>Removal of paint</p> <p>This wheel is suitable for removal of polyurethane, adhesive, paint, epoxy and acrylic coating. PCD is an abbreviations of "Polycrystalline Diamond". It is a kind of an artificial diamond and superior in hardness and durability.</p>
<p>Vacuum brazed</p> 	<p>For hard materials</p> <p>This wheel is suitable for hard materials. Diamonds are held tightly.</p>

Low Vibration Offset Diamond Wheel

	<p>Low Vibration</p> <p>The vibration is not conducted to the worker's hand and able to ease the load a lot!!</p> <p>Less Tapping</p> <p>Clinging to the material and able to cut smoothly, faster and more efficient.</p> <p>Low Vibration Type</p> <p>Normal  → Low Vibration Type </p>
---	---

Diamond

Offset diamond wheel

AA: Specially suitable, A: Suitable
(EN) : EN13236



Rough Work
Single type

Three-star range

★★★

D	T	X	H	d	For Material					Model No.	Part No.
					1	2	3	4	5		
105	8	4.0	22.23	-	A	AA	A	A	A	115mm Grinder	B-14629

One-star range

★

100	0.8	2.2	16	-	A	AA	A	A	A	100mm Grinder	D-62284
-----	-----	-----	----	---	---	----	---	---	---	---------------	---------

Standard work

Double type
• Stable work



Three-star range

★★★

D	T	X	H	d	For Material					Model No.	Part No.
					1	2	3	4	5		
125	8	5	22.23	-	AA	AA	AA	A	A	PC5010C 125mm Grinder	B-12295(EN)

Two-star range

★★

125	7	5	22.23	-	A	AA	A	A	A	PC5010C	D-41458(EN)
-----	---	---	-------	---	---	----	---	---	---	---------	-------------

Segmented type

• More clean surface finish



Three-star range

★★★

D	T	X	H	d	For Material					Model No.	Part No.
					1	2	3	4	5		
100	8	5	22.23	16	AA	AA	AA	A	A	100mm Grinder	A-87105

Fine work

Turbo type
• Good dust removal, and high efficiency
• Stable work and easy to grind the corners



Three-star range

★★★

D	T	X	H	d	For Material					Model No.	Part No.
					1	2	3	4	5		
105	10	5	22.23	-	A	AA	A	A	A	115mm Grinder	B-44993

Rim type

- More clean surface finish
- Stable work and easy to grind the corners



Three-star range

★★★

D	T	X	H	d	For Material					Model No.	Part No.
					1	2	3	4	5		
125	13.5	4	22.23	-	AA	AA	AA	A	A	PC5010C 125mm Grinder	B-12289(EN)

One-star range

★

125	13	5	22.23	-	AA	AA	AA	A	A	PC5010C 180mm Grinder	D-41464(EN)
-----	----	---	-------	---	----	----	----	---	---	-----------------------	-------------

Specialized/ PCD Offset Diamond Wheel

This Offset Diamond Wheel can be used for removing of polyurethane, adhesive, paint, epoxy and acrylic coatings.

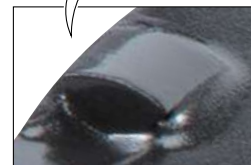

< Difference with the normal offset diamond >



It just scratched the surface and couldn't remove the paint film.

Specialized

D	T	X	H	d	For Material					Model No.	Part No.
					1	2	3	4	5		
125	-	-	22.23	-	-	-	-	-	-	PC5010C 125mm Grinder	B-53160
180	-	-	22.23	-	-	-	-	-	-	PC5010C 180mm Grinder	B-53176

Diamond

SDS-Plus Diamond core bit (Dry type)

When drilling with diamond core bit, always use "rotation only".
SDS-Plus adapter (with center bit) A-87563



For Model:
SDS-PLUS hammers
Spindle thread M18



Capacity (Diameter x Depth)	Part No.
38 x 175mm	A-87535
54 x 175mm	A-87541
65 x 175mm	A-87557

Vacuum brazed diamond pin drill



For: 13mm Driver Drill
Material : Granite/Marble/Porcelain Tile

Size	Spindle thread	Part No.
6mm	6mm x 12.5mm	B-51823
8mm	8mm x 12.5mm	B-51839
10mm	10mm x 12.5mm	B-51845

Vacuum brazed diamond core bit



Diamond Core Drill Bit for Grinders	
Type	Vacuum brazed
Fix	Special chemical bond
Fixing strength of diamond	High
Cutting material	Marble, Granite, Porcelain Tile
Precision of cutting	Middle

For: 115mm, 125mm, 150mm, 180mm, 230mm Angle Grinder
Material : Granite/Marble/Porcelain Tile

Size	Spindle thread	Part No.
5 mm	M14 x 2	D-61064
6mm	M14 x 2	D-61070
8mm	M14 x 2	D-61086
10mm	M14 x 2	D-61092
12mm	M14 x 2	D-61101
14mm	M14 x 2	D-44432
16mm	M14 x 2	D-44448
20mm	M14 x 2	D-44454
22mm	M14 x 2	D-44460
25mm	M14 x 2	D-44476
27mm	M14 x 2	D-44482
30mm	M14 x 2	D-44498
32mm	M14 x 2	D-44507
35mm	M14 x 2	D-44513
38mm	M14 x 2	D-44529
40mm	M14 x 2	D-44535

Spindle thread M10
For: 100mm Angle Grinder

Size	Spindle thread	Part No.
5mm	M10 x 1.5	D-63264
6mm	M10 x 1.5	D-63270
8mm	M10 x 1.5	D-63286
10mm	M10 x 1.5	D-63292
12mm	M10 x 1.5	D-63301
14mm	M10 x 1.5	D-63317
16mm	M10 x 1.5	D-75122
20mm	M10 x 1.5	D-63339
25mm	M10 x 1.5	D-63345
32mm	M10 x 1.5	D-63351
37mm	M10 x 1.5	D-63367
40mm	M10 x 1.5	D-63373
50mm	M10 x 1.5	D-63389

ACCESSORIES

▣ Planing / Routering



Wood



Aluminum



High speed steel

Planing / Routering

Planer blade/ HSS (2 per pkg.)

HSS(High Speed Steel): Fine cutting surface.
TC(Tungsten Carbide): Higher durability.
Suitable for hard wood.



For Model	Size (mm)	Material	Part No.
1600	80	HSS	D-65501
	80	HSS	793001-2
1100/N, N1900B, 1902, N1923B/H, KP0810/C, KP0800, DKP180, DKP181	82	HSS	D-16346
	82	HSS	A-07406
	82	TC	793007-0
	82	TC	D-07967
	82	TC	D-72207
1002BA, 1911B	110	HSS	D-71211
	110	TC	D-08822
	110	TC	793009-6
1804N	136	TC	793012-7
	136	HSS	D-71227
1805N	155	TC	793015-1
	155	HSS	D-70910
2031, 2034	155	HSS	D-63915
2012NB	306	HSS	199911-5
2030	306	HSS	793018-5
2040	400	HSS	793019-3

Mini planer blade

(2 blades per pkg.)
The blade has edges on both sides for long life.
HSS(High Speed Steel): Fine cutting surface.
TC(Tungsten Carbide): Higher durability.



For Model	Size (mm)	Material	Type	Part No.
1100/N, N1900B, 1902, N1923B/H, KP0810/C, KP0800, DKP180, DKP181	82	TC	-	A-82921
	82	TC	-	D-07945
	82	TC	-	D-70823
2012NB	306	HSS	-	793346-8

Cutter blade

Carbide-tipped plate joiner blade



For Model:
3901, PJ7000, DPJ180, DPJ140

Blade Dia. (mm)	Hole Dia. (mm)	Tip Thickness (mm)	Part No.
100	22	4	B-20644

Drywall guide bit

HSS(High Speed Steel): Fine cutting surface.
TC(Tungsten Carbide): Higher durability.
Suitable for hard wood.



For Model:	Size	Type	Per Pkg.	Part No.
3706, DCO181	3.00mm	-	1	193450-7
	1/8"	-	1	191G69-8

Cutter blade

Dia. 120mm
For Model:
3501N



Width (mm)	Region A Part No.	Width (mm)	Part No.
2.4	793021-6	12	793031-3
5.5	793026-6	18	793041-0
-	-	21	793042-8
7.5	793028-2	30	793043-6
-	-	33	793044-4
10.5	793030-5	36	793045-2

Planing / Routering

Router bit set

(12 pc/ set)

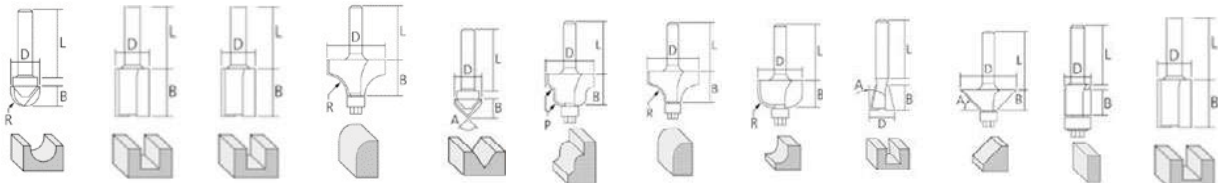

(mm)

Size	#1	#2	#3	#4	#5	#6	#7	#8	#9	#10	#11	#12	Part No.
8													A-88054
6	D:12.7 R:6.35 B:8.8 L:29.0	D:16.0 B:20.0 L:28.0	D:6.0 B:20.0 L:25.0	D:28.6 R:9.5 B:17.0 L:25.5	D:12.7 B:9.1 A:90° L:29.0	D:25.0 R:4.0 B:16.0 L:26.5	D:22.2 R:6.3 B:13.5 L:25.0	D:22.0 R:6.3 B:12.7 L:26.5	D:12.7 B:12.7 A:14° L:29.0	D:32.0 B:12.2 A:45° L:30.0	D:12.7 B:13.0 L:29.0	D:12.0 B:20.0 L:28.0	A-87921
1/4"													A-91051

Router bit assortment

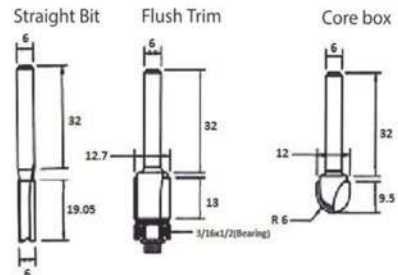

Range	Shank dia. mm(inch)	Note	Sales pkg q'ty	Part No.
★★★☆☆	6	Straight bit 2flute (6mm), Flush trim bit (12.7mm), Core box bit (12mm)	3	D-30209

Router bit set

(3 pc/ set)

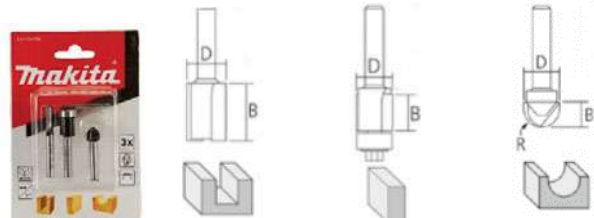

Size	#1	#2	#3	Part No.
1/4"	D:1/4" B:3/4"	D:1/2" B:1/2"	D:1/2" B:3/8" R:1/4"	D-70465

Planing / Routering

Straight bit 1flute



Range	Shank dia. mm(inch)	Overall dia. mm(inch)	Length mm(inch)	Carbide height mm(inch)	Sales pkg q'ty	Part No.
★★★★☆	6	6	50	18	1	D-09167
	(1/4)	(15/64)	(2-1/32)	(23/32)	1	D-09173
★★★☆☆	6	6	51	19	1	D-47416
	8	3	51	13	1	D-47379
	8	4	51	13	1	D-47385
	8	6	51	19	1	D-47400
	(1/4)	(1/4)	(2)	(3/4)	1	D-49030
	(1/2)	(1/4)	(2-1/2)	(3/4)	1	D-62739
	(1/2)	(3/8)	(2-1/2)	(1)	1	D-62745

Straight bit 2flute



Range	Shank dia. mm(inch)	Overall dia. mm(inch)	Length mm(inch)	Carbide height mm(inch)	Sales pkg q'ty	Part No.
★★★★☆	6	8	52	20	1	D-09260
	6	20	52	20	1	D-09313
	12	10	38	30	1	D-10182
	12	12	61	30	1	D-07892
	(1/4)	(5/16)	(2-1/64)	(3/4)	1	D-15388
	(1/4)	(3/4)	(2-1/64)	(3/4)	1	D-15431
	(1/2)	(25/64)	(2-47/64)	(1)	1	D-15512
	(1/2)	(15/32)	(2-13/32)	(1-3/16)	1	D-07901
★★★☆☆	6	6	57	25	1	D-47438
	6	8	51	19	1	D-47444
	6	8	57	25.4	1	D-47450
	6	10	57	25.4	1	D-47466
	6	12	64	32	1	D-47472
	6	14	51	19	1	D-47488
	8	6	48	16	1	D-47503
	8	6	51	19	1	D-47519
	8	8	51	19	1	D-47525
	8	10	51	19	1	D-47531
	8	20	51	19	1	D-47581
	8	22	57	25.4	1	D-47597
	8	24	57	25.4	1	D-47606
	12	10	70	25.4	1	D-47628
	12	19	73	32	1	D-47662
	12	25	73	32	1	D-47684
	(1/4)	(1/4)	(2-1/4)	(1)	1	D-49052
	(1/2)	(1/4)	(2-1/2)	(3/4)	1	D-62751
	(1/2)	(1/2)	(2-5/8)	(1)	1	D-62767
	(1/2)	(1/2)	(3)	(1-1/2)	1	D-62773
	(1/2)	(1/2)	(4)	(2)	1	D-62810
	(1/2)	(3/4)	(2-5/8)	(1)	1	D-62789
	(1/2)	(3/4)	(3)	(1-1/2)	1	D-62795
	(1/2)	(7/8)	(2-5/8)	(1)	1	D-62804

Straight bit 2flute with top bearing



Range	Shank dia. mm(inch)	Overall dia. mm(inch)	Length mm(inch)	Carbide height mm(inch)	Sales pkg q'ty	Part No.
★★☆☆☆	(1/2)	(3/4)	(2-13/16)	(1)	1	D-62826

Flush trim bit 2flute



Range	Shank dia. mm(inch)	Overall dia. mm(inch)	Length mm(inch)	Carbide height mm(inch)	Sales pkg q'ty	Part No.
★★★★☆	6	9.5	58	25.4	1	D-09472
	(1/4)	(3/8)	(2-39/64)	(1)	1	D-04313
★★★☆☆	6	9.5	67	26	1	D-47690
	6	12.7	56	13	1	D-47709
	8	9.5	67	26	1	D-47721
	8	12.7	56	13	1	D-47737
	(1/4)	(3/8)	(2-5/8)	(1)	1	D-49264
	(1/4)	(1/2)	(2-3/16)	(1/2)	1	D-49270
	(1/2)	(1/2)	(3-19/32)	(1-1/2)	1	D-62832
	(1/2)	(1/2)	(4-1/64)	(2)	1	D-62848
	(1/2)	(3/4)	(3)	(1)	1	D-62854
	(1/2)	(3/4)	(3-5/16)	(1-1/4)	1	D-62860

Panel pilot bit



Range	Shank dia. mm(inch)	Overall dia. mm(inch)	Length mm(inch)	Carbide height mm(inch)	Sales pkg q'ty	Part No.
★★★★☆	6	6	65	19	1	D-09335
★★★☆☆	6	6.35	65	19	1	D-47771
	8	6.35	65	19	1	D-47787
	12	9.5	75	26	1	D-47793

Planing / Routing

Sash router bit



Range	Shank dia. mm(inch)	Overall dia. mm(inch)	Length mm(inch)	Carbide height mm(inch)	Sales pkg q'ty	Part No.
★★★★☆	6	6	65	18	1	D-16988
	(1/4)	(15/64)	(2-9/16)	(45/64)	1	D-16972

Range	Shank dia. mm(inch)	Overall dia. mm(inch)	Length mm(inch)	Carbide height mm(inch)	(°)	Sales pkg q'ty	Part No.
★★★★☆	12	15.9	51	12.7	90	1	D-47927
	12	19	57	16	90	1	D-47949
	12	28.6	60	22.2	90	1	D-47955
	(1/4)	(3/4)	(1-7/8)	(5/8)	90	1	D-49373
	(1/2)	(7/8)	(2-1/4)	(5/8)	90	1	D-62907
	(1/2)	(1)	(2-3/8)	(3/4)	90	1	D-62913

Core box bit



Range	Shank dia. mm(inch)	Overall dia. mm(inch)	Length mm(inch)	Carbide height mm(inch)	R1 mm (inch)	Sales pkg q'ty	Part No.
★★★★☆	8	6.35	38	6.35	3.2	1	D-47977
	8	12.7	41	10	6.35	1	D-48000

Ovolo bit



Range	Shank dia. mm(inch)	Overall dia. mm(inch)	Length mm(inch)	Carbide height mm(inch)	R1 mm (inch)	Sales pkg q'ty	Part No.
★★★★☆	6	16	41	9	4	1	D-09357
	6	25	45	13	8	1	D-09363

Round nose bit



Range	Shank dia. mm(inch)	Overall dia. mm(inch)	Length mm(inch)	Carbide height mm(inch)	R1 mm (inch)	Sales pkg q'ty	Part No.
★★★★☆	6	6	48	13	3	1	D-09329
★★★★☆	6	6.35	44	12.7	3.2	1	D-47802
	6	9.5	44	12.7	4.8	1	D-47818
	8	6.35	44	12.7	3.2	1	D-47830
	8	9.5	44	12.7	4.8	1	D-47846
	(1/4)	(1/4)	(1-3/4)	(1/2)	(1/8)	1	D-49345
	(1/2)	(3/8)	(2-1/4)	(1/2)	(3/16)	1	D-62876
	(1/2)	(1/2)	(2-3/8)	(3/4)	(1/4)	1	D-62882
	(1/2)	(3/4)	(2-5/8)	(1)	(3/8)	1	D-62898

Roundover bit



Range	Shank dia. mm(inch)	Overall dia. mm(inch)	Length mm(inch)	Carbide height mm(inch)	R1 mm (inch)	Sales pkg q'ty	Part No.
★★★★☆	6	19	42	9.5	3	1	D-09422
	6	25	45	13	6	1	D-09444
	(1/4)	(7/8)	(2-3/16)	(1/2)	(3/16)	1	D-15475
★★★★☆	8	17.3	51	8	2.3	1	D-48343
	8	20.7	52	10	4	1	D-48365
	8	22.2	55	12.7	4.8	1	D-48371
	8	25.4	56	13.5	6.35	1	D-48387
	8	28.6	57	14.5	7.9	1	D-48393
	(1/2)	(5/8)	(2-5/32)	(15/32)	(1/16)	1	D-63046
	(1/2)	(3/4)	(2-5/16)	(3/8)	(1/8)	1	D-63052
	(1/2)	(1-1/4)	(2-11/16)	(21/32)	(3/8)	1	D-63068
	(1/2)	(1-1/2)	(2-11/16)	(3/4)	(1/2)	1	D-63074

V groove bit

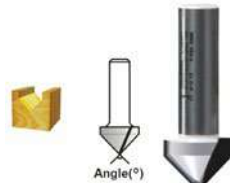

Range	Shank dia. mm(inch)	Overall dia. mm(inch)	Length mm(inch)	Carbide height mm(inch)	(°)	Sales pkg q'ty	Part No.
★★★★☆	6	19	53	20	60	1	D-09391
★★★★☆	6	12.7	45	12.7	90	1	D-47868
	6	12.7	48	16	60	1	D-47874
	6	19	48	16	90	1	D-47880
	8	12.7	45	12.7	90	1	D-47896
	8	12.7	48	16	60	1	D-47961
	8	15.9	44	12.7	90	1	D-47905
	8	19	48	16	90	1	D-47933
★★★★☆	12	12.7	54	12.7	90	1	D-47911

Planing / Routing

Beading bit



Range	Shank dia. mm(inch)	Overall dia. mm(inch)	Length mm(inch)	Carbide height mm(inch)	R1 mm (inch)	Sales pkg q'ty	Part No.
★★★★☆	6	21	42	9.5	4	1	D-09525
	6	28	45	13	8	1	D-09547
★★★☆☆	6	20.3	51	10	4	1	D-48452
	6	22.2	53	12.7	4.8	1	D-48468
	6	28.6	56	14.5	7.9	1	D-48474
	8	20.7	51	10	4	1	D-48505

Cove bit



Range	Shank dia. mm(inch)	Overall dia. mm(inch)	Length mm(inch)	Carbide height mm(inch)	R1 mm (inch)	Sales pkg q'ty	Part No.
★★★★☆	6	20	40	8	4	1	D-09400
	6	25	45	13	8	1	D-09416

Cove with fillet bit



Range	Shank dia. mm(inch)	Overall dia. mm(inch)	Length mm(inch)	Carbide height mm(inch)	R1 mm (inch)	Sales pkg q'ty	Part No.
★★★★☆	6	22	42	10	3	1	D-09553

Chamfer bit

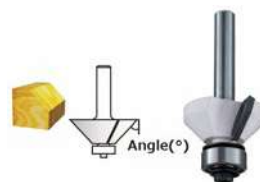

Range	Shank dia. mm(inch)	Overall dia. mm(inch)	Length mm(inch)	Carbide height mm(inch)	(°)	Sales pkg q'ty	Part No.
★★★★☆	6	25.4	51	11	45	1	D-48658

Ogee bit



Range	Shank dia. mm(inch)	Overall dia. mm(inch)	Length mm(inch)	Carbide height mm(inch)	R1 mm (inch)	Sales pkg q'ty	Part No.
★★★★☆	8	31.8	56	12.7	4.8	1	D-48773

Roman ogee bit



Range	Shank dia. mm(inch)	Overall dia. mm(inch)	Length mm(inch)	Carbide height mm(inch)	R1 mm (inch)	Sales pkg q'ty	Part No.
★★★★☆	6	24	42	10	2.5	1	D-09575
	6	28	44	12	3	1	D-09581
★★★☆☆	6	25.4	52	9.5	3.2	1	D-48804
	8	38.1	60	17.5	6.35	1	D-48767

Classic panel bit



Range	Shank dia. mm(inch)	Overall dia. mm(inch)	Length mm(inch)	Carbide height mm(inch)	R1 mm (inch)	Sales pkg q'ty	Part No.
★★★☆☆	8	12.7	42	10	2.4	1	D-48206
	12	25.4	54	16	5.6	1	D-48228

Dovetail bit

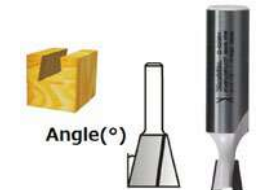

Range	Shank dia. mm(inch)	Overall dia. mm(inch)	Length mm(inch)	Carbide height mm(inch)	(°)	Sales pkg q'ty	Part No.
★★★☆☆	8	6.35	64	8	7.5	1	D-48050

Slotting cutter



Range	Shank dia. mm(inch)	Overall dia. mm(inch)	Length mm(inch)	Carbide height mm(inch)	Note	Sales pkg q'ty	Part No.
★★★☆☆	8	47.6	59	2	With Arbor	1	D-48941
	8	47.6	59	4		1	D-48979

ACCESSORIES

Outdoor Power Equipment



Outdoor Power Equipment

Earth auger drill bit with adapter D shank



Suitable for drilling sandy soil and soil which contains grassroots and pebbles.
Used for topdressing · tree planting to fruit trees and also for drilling prepared hole which needs for hammering in various types of pile.

Earth auger drill bit

Diameter	Length	Working Length	Part No.
ø100 mm	800 mm	550 mm	E-07294
ø150 mm			E-07303
ø200 mm			E-07319

Earth auger drill bit extension bar (540mm) E-07325

Pin for earth auger drill E-07331

Use with bit adapter Type D 327687-6



Compared to our conventional product which only has one spiral groove, this new product has two spiral groove which make drilling more stable. It also leads to 10% increase on drilling speed compared to the conventional product.

Two different types of cutting edge shape (flat cutter and sharp cutter) makes it possible to deal with various soil.

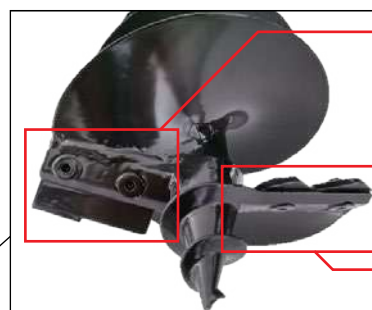

Flat cutter



Flat cutter is suitable for soil with grassroots

Sharp cutter



Sharp cutter is suitable for soil with pebbles.













Blade for earth auger drill bit
(Changing cutter blade set)

Diameter	Part No.
For 100 mm	E-07630
For 150 mm	E-07646
For 200 mm	E-07652

*Diameter 200mm is used only for sandy soil.

Outdoor Power Equipment

Blade selection guide

Blade type / Image				
		Short and soft grass	Tall and hard grass	Bush including tree beginning to grow
Nylon cord		←→		
Plastic blade		←→		
Metal blade		←→		
		←→		
		←→		
Brushcutter blade		←→		
Shredder blade			←→	
Saw blade				←→
Chisel blade				←→
T.C.T. saw blade		←→		

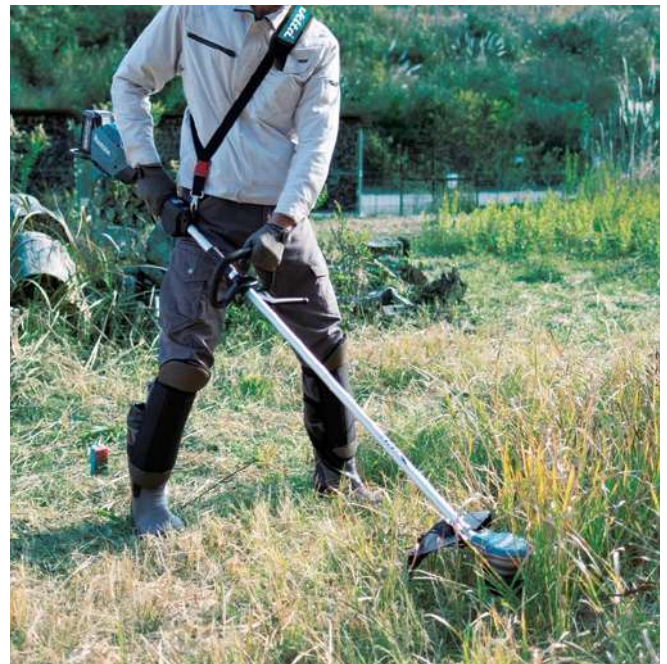

Outdoor Power Equipment

Shape	Application	Blade Dia. / No. of Teeth	Thickness	Model	Part No.
80-tooth blade					
	for bushes and thin tree trunks Not available in some countries due to local regulation	230mm / 80	1.8mm	DUR361U, DUR362U, EBH252U, EBH253U, EM2500U/L, EM2510LH, EM2511LH, EM2600U/L, EM2650LH/UH, EM2651LH/UH, EM2653LH, EM2654LH, EM400MP, EM401MP, EM402MP, EM403MP, EM404MP	B-14152
		255mm / 80	2.0mm	EBH340U/R, EBH341L/U/R, EM3400U/L, EM4350UH/LH/RH, EM4351UH, RBC411U, RBC412U, RBC413U, RBC414U	B-14168

TCT Saw blade

	for gnarled bushes and thin tree trunks Not available in some countries due to local regulation	230mm / 36	1.25mm	EBH252U, EBH253U, EBH340U/R, EBH341U/L, EBH341R, EM2500U/L, EM2510LH, EM2511LH, EM2600U/L, EM2650L/U, EM2651L/U, EM2653LH, EM2654LH, EM4340L	D-65981
		250mm / 40	1.25mm	EBH340U/R, EBH341L/U/R, EM2901LH/UH, EM2904LH, EM3400U/L, EM4350UH/LH/RH, EM4351UH, RBC411U, RBC412U, RBC413U, RBC414U	A-48337 A-53958
		255mm / 4	2.0mm	EBH340U/R, EBH341L/U/R, EM4350UH/LH/RH, EM4351UH, RBC411U, RBC412U, RBC413U, RBC414U	B-14124



Edger blade



Blade Dia. / No. of Teeth	Thickness	Model No.	Part No.
203mm / 2	2.5mm	EE2650H, EE400MP	196745-7

Brushcutter blades

Hole Dia.: 25.4mm

Shape	Application	Blade Dia. / No. of Teeth	Thickness	Model	Part No.
2-tooth blade					
	for tall grass and scrub	230mm / 2	2.0mm	EBH252U, EBH253U, EM2500U/L, EM2510LH, EM2511LH, EM2600U/L, EM2650LH/UH, EM2651LH/UH, EM2653LH, EM2654LH, EM400MP, EM401MP, EM402MP, EM403MP, EM404MP	197808-2 D-66058
4-tooth blade					
	for tall grass and scrub	230mm / 4	1.8mm	DUR361U, DUR362U, EBH252U, EBH253U, EM2500U/L, EM2510LH, EM2511LH, EM2600U/L, EM2650LH/UH, EM2651LH/UH, EM2653LH, EM2654LH, EM400MP, EM401MP, EM402MP, EM403MP, EM404MP	B-14118
		230mm / 4	1.8mm	DUR365U, DUR368A/L, DUR369A/L, UR101C, UR201C, EM401MP, EM402MP	D-66008
		255mm / 4	2.0mm	EBH340U/R, EBH341L/U/R, EM4350UH/LH/RH, EM4351UH, RBC411U, RBC412U, RBC413U, RBC414U	B-14124
8-tooth blade					
	for thick grass and scrub	255mm / 8	2.0mm	EBH340U/R, EBH341L/U/R, EM3400U/L, EM4350UH/LH/RH, EM4351UH, RBC411U, RBC412U, RBC413U, RBC414U	B-14146

Outdoor Power Equipment

Shape	Ref	Size	Thread Size	Model No.	Cord/Line	Package	Part No.	
Quick loading Bump & Feed								
	96-M8L	4"	M8x1.25LH	DUR142L, DUR142U, DUR143U, DUR182L, DUR182U, DUR183L, DUR183U, DUR187L, DUR187U, DUR188L, DUR188U	2.0mm x 4m	Carton box	191D91-7	
	96-M8R		M8x1.25RH	DUR189, DUR364	2.0mm x 4m	Carton box	191D92-5	
	96-M10L	4"	M10x1.25LH	DUR190L, DUR190U, DUR191L, DUR191U, DUR192L, UR201C, UR202C, DUR365, DUR366, DUR368A, DUR368L, DUR369A, DUR369L, DUR369N, EM408MP, EM409MP, UR001G, UR002G, UR003G, UR004G, UR101C	2.0mm x 4m	Carton box	191D89-4	
				DUR369A, DUR369L, DUR369N, EBH252L, EBH252U, EBH253L, EBH253U, EM2510L, EM2511L, EM2650U, EM2651L, EM2651U, EM2653L, EM2654L, EM400MP, EM401MP, EM403MP, EM404MP, EM405MP, EM406MP, UR101C, UR201C, UR202C	2.4mm x 3m	Carton box	191D90-9	
21-M10L	5"	M10x1.25LH	EBH341L, EBH341U, EM4350L, EM4350R, EM4350U, EM4351U, MS335C, RBC411, RBC412U, RBC413U, RBC414U	2.4mm x 4m	Carton box	191D93-3		
Bump & Feed								
	76-M8R	3"	M8x1.25RH	UR100D	1.65mm x 8m	Poly bag with header	198853-0	
	95-M10L	4"	M10x1.25LH	DUR190L, DUR190U, DUR191L, DUR191U, DUR192L, UR366L, DUR368A, DUR368L, DUR369A, DUR369L, DUR369N, EBH252U/L, EBH253U/L, EM2510LH, EM2511LH, EM2650UH/LH, EM2651UH/LH, EM2653LH, EM2654LH, UR002G, UR003G, UR101C, UR201C, UR202C, EM400MP, EM401MP, EM403MP, EM404MP, EM405MP, EM406MP, EM408MP, EM409MP	2.0mm 3m 2.4mm x 3m	Poly bag with header Poly bag with header	198892-0 197804-0	
Bump & Feed								
	B & F ECO 4R	4" Low profile	M8x1.25RH	DUR189, DUR364L	2.0mm x 3m	Poly bag with header	197297-1	
	B & F ECO 4L	4" Low profile	M10x1.25LH	DUR192L, DUR366L, DUR368A, DUR368L, DUR369A, DUR369L, DUR369N, UR002G, UR003G, UR101C, UR201C, UR202C, EM408MP, EM409MP		Poly bag with header	197296-3	
	B & F ZSL	5"	M10x1.25LH	EBH252U/L, EBH253U/L, EM2510LH, EM2511LH, EM2650UH/LH, EM2651UH/LH, EM2653L, EM2654L, EM3400U/L, EBH340U, EBH341U/L/R, EM4350UH/LH/RH, EM4351UH, RBC411U, RBC412U, RBC413U, RBC414U, EM400MP, EM401MP, EM403MP, EM404MP, EM405MP, EM406MP	2.4mm x 3m	Blister pack	B-05131	
Automatic feed and Bump & Feed								
	<p>Line will be feeded about 3cm, in either one of the following cases</p> <ul style="list-style-type: none"> -Head rotation are reached at 8,500rpm. -Bottom of the head is bumped on the ground when it is spinning. 	Ultra Auto 4R	4"	M8x1.25RH	ER2550L, ER2650L, ER2600L, ER400MP	2.4mm x 3m	Carton box	B-03006
		Ultra Auto 4L	4"	M8&10x1.25 LH	DUR187U/L, DU188U/L, EM2500U/L, EM2600U/L, EBH252U/L, EBH253U/L, EM2510LH, EM2511LH, EM2650UH/LH, EM2651UH/LH, EM2653LH, EM2654LH, EM400MP, EM401MP, EM403MP, EM404MP, EM405MP, EM406MP	2.4mm x 3m	Carton box	*B-02945

Outdoor Power Equipment

String trimmer head

(for grass, light weeds)

* with adapter (Poly bag with header)

Quick loading Trimmer Head (UN-74L, UN-72L, 96-M8L/R, 96-M10L, 121-M10L)

Nylon cord can be feeded without opening the head



0 85(sec.)



0 35(sec.)



Up to **58%**
less feeding time!

Shape	Ref	Size	Thread Size	Model No.	Cord/Line	Package	Part No.
Quick loading Bump & Feed							
	UN-74L	4.4"	M10x1.25LH	DUR190L, DUR366L, DUR368A, DUR368L, DUR369A, DUR369L, DUR369N, EBH252U/L, EBH253U/L, EBH341U, EM3400L, EM2510LH, EM2511LH, EM2650UH/LH, EM2651UH/LH, EM2653LH, EM2654LH, UR002G, UR003G, UR101C, UR201C, UR202C, EM400MP, EM401MP, EM403MP, EM404MP, EM405MP, EM406MP	2.4mm x 3.6m	-	196324-1

Cordless string trimmer

Model No.	Spindle Size	Receive Washer		Grass Guard for Receive Washer
		Size (mm)	Part No.	
DUR184L	M8x1.25RH	36.5	326683-1 144512-4	346857-8
DUR187L	M10x1.25LH	36.5	144512-4	346857-8
DUR189	M8x1.25RH	36.5	144512-4	346857-8
DUR192L, DUR190	M10x1.25LH	36.5	140W47-1	346857-8

Model No.	Spindle Size	Receive Washer		Grass Guard for Receive Washer
		Size (mm)	Part No.	
DUR364L	M8x1.25RH	44	319245-2	346857-8
DUR365U, DUR366L	M10x1.25LH	42	326518-6 140L84-9	346622-5
DUR368L	M8x1.25RH	-	140L84-9	-
DUR369L	M10x1.25LH	64.5	144312-2	-
UR202C	M10x1.25LH	65	140N88-3	-

Outdoor Power Equipment

Line character

Shape	Sharpness	Energy Saving	Quietness
Four-leaf	A	AA	AA

Four-Leaf Line

Low noise and energy saving

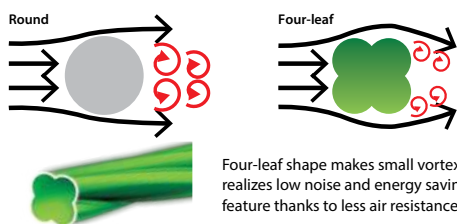

Color chart

Dia.	Color / Shape	Light duty		Heavy duty	
		Short grass		Tall grass	
		Low density	High density	Low density	High density
1.3mm	○	↔			
1.6mm - 1.65mm	⊕ ⊙	↔			
2.0mm	⊕ ⊙		↔		
2.4mm	⊕ ⊙ □		↔	↔	
2.7mm	⊕ ⊙			↔	↔
3.0mm	○ ⊙ □				↔

The amount of cutting per 1 charge

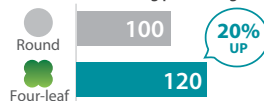

Noise

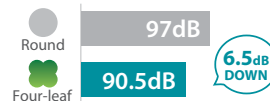

Color / Shape	Layer	Dia. (mm)	Length(m)	Part No.
⊕	Single	1.65	15	E-01731
	Single	2	15	E-01769
⊕	Single	2	30	197473-7 E-01775
	Single	2	310	E-01781
	Single	2.4	15	198501-1 E-01797
⊕	Single	2.4	30	198502-9 E-01806
	Single	2.4	225	E-01812
⊕	Single	2.7	15	E-01828
	Single	2.7	30	E-01834
	Single	2.7	180	E-01840

Other Nylon cord (round, natural)





Size	Part No.
1.65mmx15m	DA00000003
2.4mmx5m	B-01971
3.0mmx4m	B-07375

Protection guard

Shape	Type	Model No.	Description	Part No.
Protector				
	Universal	DUR369A, DUR369L, UR101C, UR201C	With protector extension	191B54-1
Extension for Trimmer head				
	Universal	EBH252L/U, EBH253L/U, EM2650LH/UH, EM2651LH/UH, EM2511LH, EM2653LH, EM2654LH, EBH341U/L, EM4350UH/LH/RH, EM4351UH, RBC411U, RBC412U, RBC413U, RBC414U, EM400MP	Toolless / With cord/line cutter	135398-7
for Cutting blade				
	Exclusive	EBH340R	-	XNR0000302
for Trimmer head				
	Exclusive	UR100D	With cord/line cutter	135950-1
		DUR189	Without cord/line cutter	456651-1
		EM405MP, EM406MP, UR101C, UR201C, UR202C, DUR369A, DUR369L, DUR369N	Narrow type / Without cord/line cutter	457273-0

Outdoor Power Equipment

Protection guard- Plastic blade set

	Model No.	Plastic Blade Set			Replacement Plastic Blade	
		Arbore Size	Cutting Width	Part No.	Per Pkg.	Part No.
 x5	UR100D	M8x1.25RH	230mm	198848-3	5	198850-6
 x12	DUR369A, DUR369L, DUR369N, UR101C, UR201C, UR202C	M10x1.25LH	305mm	199868-0	12	199870-3

Spool assembly



Model No.	Part No.
UR3000	DA00000001
DUR181	195858-1
DUR193	191Y39-5

Shoulder strap assembly

Shape	Model No.	Part No.
Singlet		
	DUN500W DUN501W, DUR181, DUR184L, DUR187L, DUR188L, DUR189, DUR190L, DUR191L, DUR364L, DUR368A, DUR368L, UR100D, UR180D, DUR366L, DUX60L, EBH252L, EBH253L, EBH341L, EM2510LH, EM2511LH, EM2650LH, EM2651LH, EM2653LH, EM2654LH, EM3400L, EN4950H, EN4951SH, EY2650H ,EX2650LH, RBC4111U, RBC412U	125516-5
	DUR192L, DUR194, UR002G, UR003G; UR006G, UR007G, DUR193, DUR194, UX18D	127508-0
Comfort		
	DUR369A, EBH252U, EBH253U, EBH341U, EM2650UH, EM2651UH, EM4350UH, RBC411U, RBC412U, RBC413U, RBC414U, UR002G	122906-3

Outdoor Power Equipment

String trimmer harness for PDC01 & PDC1200



Item	Part No.
A	191E43-4
B	197243-4

Attachments for loop handle brushcutter

Do not use following attachments with DUR369L, DUR369N, UR201C & UR202C.

Shape	Model No.	Part No.
Hedge trimmer Blade length: 490mm	EM2650LH, EM2651LH, EM2653LH, EN2654LH	198579-4

Pole saw Bar length: 25cm (10") Saw chain: 91VXL-39links Motor Mount:A218	EM2650LH, EM2651LH.	A-89539
---	------------------------	---------

Coffee harvester	EM2651LH	B-80210
-------------------------	----------	---------

Attachments for back pack brushcutter

Do not use following attachments with DUR369L, DUR369N, UR201C & UR202C.

Shape	Model No.	Part No.
Coffee harvester	EBH340R, EBH341R	B-80226

Coffee harvester	EBH340R, EBH341R	197163-2
-------------------------	------------------	----------



Multi-tool attachments

Shape	Model No.	Part No.
Brushcutter Cutting width: 420mm Spindle size: M10 x 1.25LH	EX2650LH	EM400MP 195658-9

Grass trimmer Spindle size: M10 x 1.25LH	DUX18, DUX60, EX2650LH, UX01G	EM408MP 191N35-7 EM409MP 191N48-8
---	----------------------------------	--

String trimmer Cutting width: 410mm Spindle size: M8 x 1.25RH	EX2650LH	ER400MP 195530-5
---	----------	---------------------

Brushcutter Blade size: 230mm Spindle size: M10 x 1.25LH	DUX60, EX2650LH	EM402MP 195952-9
--	-----------------	---------------------

Rotary scissors Blade size: 230mm Spindle size: M8 x 1.25 LH	DUX60, EX2650LH	EM407MP 191M60-2
--	-----------------	---------------------

Blower

Shape	Model No.	Part No.
	DUX18, DUX60, EX2650LH, UX01G	UB400MP 191F72-3

Blower	DUX18, DUX60, EX2650LH, UX01G	UB401MP 191P78-1
---------------	----------------------------------	---------------------

Blower	DUX18, DUX60, UX01G	UB402MP 191250-7
---------------	------------------------	---------------------

Outdoor Power Equipment

Pole saw

*Except for European, Australian, New Zealand, Chinese & Korean markets.

Shape	Model No.	Part No.
Bar length: 25cm (10") (EY401MP), 30cm (12") (EY403MP) Saw chain: 91VXL-39links Motor Mount:A218		
	DUX18, DUX60, EX2650LH, UX01G	EY401MP 199925-4
	DUX18, DUX60, EX2650LH, UX01G	EY403MP 191T41-8

Pole hedge trimmer

Shape	Model No.	Part No.
-------	-----------	----------

Angle adjustment

	DUX18, DUX60, EX2650LH, UX01G	EN401MP 196341-1
---	----------------------------------	---------------------

Straight

	DUX18, DUX60, EX2650LH, UX01G	EN410MP 197742-6
---	----------------------------------	---------------------

Ground trimmer.25LH

	DUX18, DUX60, EX2650LH, UX01G	EN420MP 198061-3
---	----------------------------------	---------------------

Cultivator

Cultivating width: 160mm

	DUX18, DUX60, EX2650LH, UX01G	KR400MP 195712-9
---	----------------------------------	---------------------

Cultivator

Cultivating width: 220mm

* Rotor LR set:
P/N:199204-0

	DUX18, DUX60, EX2650LH, UX01G	KR401MP 195716-1
---	----------------------------------	---------------------



Shape	Model No.	Part No.
-------	-----------	----------

Power brush

* Brush wheel (1pc)
P/N: XNR0000548

	DUX18, DUX60, EX2650LH, UX01G	BR400MP 199323-2
--	----------------------------------	---------------------

Power sweep

* Sweeper wheel (1pc):
P/N: XNR0000549

	DUX18, DUX60, EX2650LH, UX01G	SW400MP 199344-4
--	----------------------------------	---------------------

Coffee harvester

	DUX18, DUX60, EX2650LH, UX01G	EJ400MP 195726-8 / 197163-2
--	----------------------------------	--------------------------------

Edger attachment

	DUX18, DUX60, EX2650LH, UX01G	EE400MP 196750-4
---	----------------------------------	---------------------

Shaft extension attachment

S For Pole saw, Pole hedge trimmer and Coffee harvester

	DUX18, DUX60, EX2650LH, UX01G	LE400MP 191E23-0
--	----------------------------------	---------------------



Outdoor Power Equipment

Saw Chain and Guide Bar

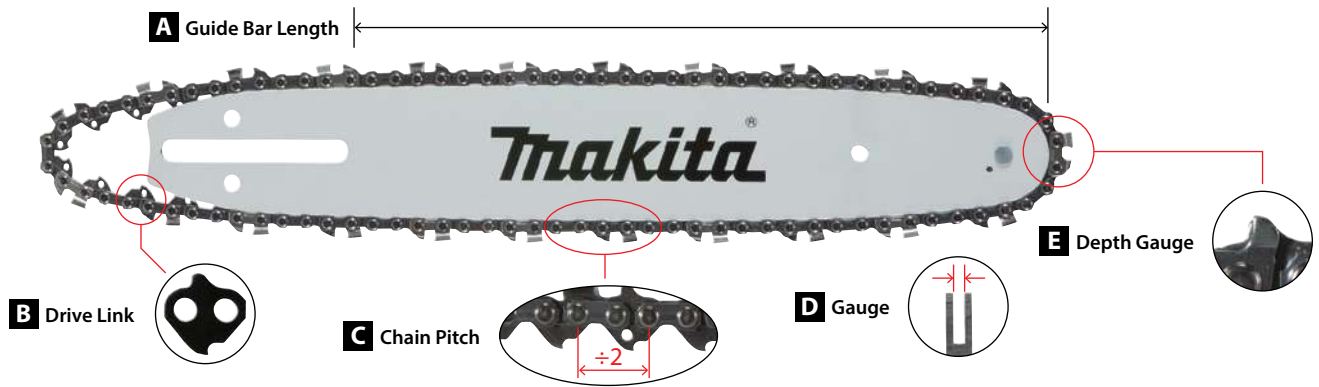

A Guide Bar Length

Guide bar's length is represented by cutting length, which is different from its total length.



B Drive Link

The length of saw chain is determined by counting the number of drive links in the saw chain.

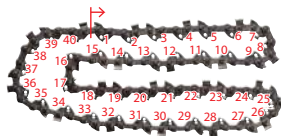

C Chain Pitch

Chain pitch is the size of the chain and it is defined by the distance between any three consecutive rivets divided by two. Pitch is important because the drive sprocket must be the same pitch as the chain.



D Gauge

Chain Gauge is thickness of drive link which will fit into the guide bar groove. Chain gauge must be the same as guide bar gauge.

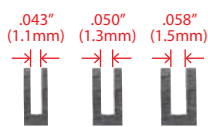

E Depth Gauge

Depth gauge determines how deep the cutting teeth gets into the wood. Cutting depth can be checked by the gap between top of cutter and depth gauge.



General Saw Chain Character

D Gauge	Cutting speed			
	Fast			Slow
C Chain Pitch	0.043" (1.1mm)	0.050" (1.3mm)	0.058" (1.5mm)	0.063" (1.6mm)
Surface condition	1/4"	25AP 25F		
	.325"LP	80		
	3/8"LP	90PX	91PX 91F 91VXL	
	.325"		20BPX 95VPX	21BPX 21LPX
	3/8"		72LPX 72V	73DPX 73LGX 73LPX
	.404"			27X 59AC

Guide Bar Type

Sprocket Nose Bars

Sprocket nose bars have a rotating sprocket mounted at the tip of the bar. As the chain moves along the bar, the sprocket teeth carry the chain around the tip smoothly with less friction.



Hard Nose Bars(Solid Bar)

High wear resistant stellite has been welded onto the tip. Hard nose bars are made for special applications, such as fire-damaged forests, deserts, or sandy environments.



Carving Bars

Carving bars are made of high-quality steel and high wear resistant stellite has been welded onto the tip. Bar tip is designed to have small radius for precision cutting. The carving bars are made for especially pruning and carving.



Guide Bar Maintenance

Chain Tension

Check the chain tension before use. The saw chain may become loose after many hours of use.



File Bar Edge

File bar edge with a flat file to keep it 90° once a week.



Clean Guide Bar

Clean out chips and sawdust every time when you sharpen or replace saw chain.



Bar Nose Grease

Lubricate a whole sprocket regularly so that the saw chain can rotate with less friction.

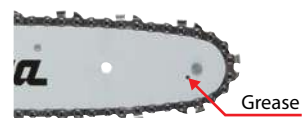

Sharpening Saw Chain

Round File and File holder



The file can be guided more easily if a file holder is employed. The file holder has markings for the correct sharpening angle of 30° (align the markings parallel to the saw chain) and limits the depth of penetration (to 4/5 of the file diameter).

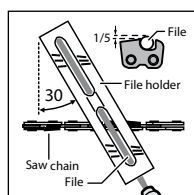

Depth gauge jointer

After sharpening the chain, check the height of the depth gauge using the chain gauge tool.

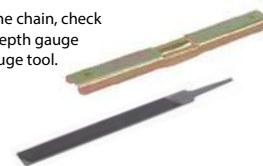

Flat file

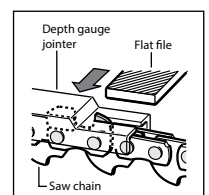

Chainsaw Accessories

Chain Saws

Guide Bar / Saw Chain / Guide Bar Cover / Drive sprocket



Guide Bar

Sprocket nose bar



Carving bar

Saw Chain



Bar Cover



Cutter type SC: Semi chisel FC: Full chisel

For Models	Guide Bar		Saw Chain					Bar Cover Part No.	File diameter, 1st half of top plate	File diameter 2nd half of top plate	Type	
	Bar length	Part No.	No. of drive links	gauge	pitch	Cutter type	Saw Chain Part No.					
BUC250	25cm/10"	1911A1-3	60	1.3mm/0.050"	1/4"	25AP	SC	194098-8/ 191G96-5	-	4.0mm	4.0mm	Carving bar
	25cm/10"	168408-5/ 191G22-4	40	1.3mm/0.050"	3/8"	91VG	SC	191H08-4	-	4.0mm	4.0mm	Sprocket
UC120D, BUC121, BUC122	16cm/6-1/4"	158476-6/ 191G59-1	42	1.3mm/0.050"	1/4"	25AP	SC	791284-8	-	4.0mm	4.0mm	-
UC3510A, UC3520A	35cm/14"	165246-6/ 191G16-9	52	1.1mm 0.043"	3/8"	90SG	SC	531 291 652	-	4,5mm	4,0mm	Sprocket
UC4010A, UC4020A	40cm/16"	191G17-7	56	1.1mm 0.043"	3/8"	90SG	SC	196742-3/ 191H03-4	419242-9	4,5mm	4,0mm	Sprocket
UC3020A	30cm/12"	191G23-2	46	1.3mm/0.050"	3/8"	91VG	SC	531 492 646	-	4.0mm	4.0mm	-
UC3520A	35cm/14"	442 035 661	52	1.3mm/0.050"	3/8"	91VG	SC	191H11-5	-	4.0mm	4.0mm	-
UC4020A	40cm/16"	191G25-8 D412 040 661	56	1.3mm/0.050"	3/8"	91VG	SC	191H12-3	419242-9	4.0mm	4.0mm	-
UC3500, UC3530A	35cm/14"	442 035 661	52	1.3mm/0.050"	3/8"	91VG	SC	191H11-5	-	4.0mm	4.0mm	-
UC4030A	40cm/16"	191G25-8	56	1.3mm/0.050"	3/8"	91VG	SC	191H12-3	419242-9	4.0mm	4.0mm	-
5012B	30cm/12"	164533-0	45	1.3mm/0.050"	3/8"	91VG	SC	196519-6	-	4.0mm	4.0mm	-
5016B	40cm/16"	341650-5	56	1.3mm/0.050"	3/8"	91VG	SC	196521-9	-	4.0mm	4.0mm	-
DUC302	30cm/12"	165245-8/ 191G15-1	46	1.1mm/0.043"	3/8"	90SG	SC	196740-7	-	4.5mm	4.0mm	Sprocket
5014B	35cm/14"	345159-9	52	1.1mm/0.043"	3/8"	90SG	SC	191H02-6	-	-	-	Sprocket
Petrol Chain Saws												
DCS231T	25cm/10"	168408-5/ 191G22-4	40	1.3mm/0.050"	3/8"	91VG	SC	191H08-4	-	4.0mm	4.0mm	Sprocket
DCS330TH	35cm/14"	442 035 661	52	1.3mm/0.050"	3/8"	91VG	SC	191H11-5	952 100 633	4.0mm	4.0mm	-
DCS3400TH, DCS3410TH	35cm/14"	442 035 661	52	1.3mm/0.050"	3/8"	91VG	SC	191H11-5	-	4.0mm	4.0mm	-
DCS3400, DCS3410	35cm/14"	D412 035 661	52	1.3mm/0.050"	3/8"	91VG	SC	191H11-5	-	4.0mm	4.0mm	-
EA3201S-35, DCS33, DCS34, DCS330, DCS330S, DCS340, DCS341, DCS344, DCS390, DCS400, DCS401	30cm/12"	442 030 661	46	1.3mm/0.050"	3/8"	91VG	SC	531 492 646	-	4.0mm	4.0mm	-
	35cm/14"	D412 035 661	52					191H11-5	-			
DCS3500, DCS3501	35cm/14"	442 035 661	52	1.3mm/0.050"	3/8"	91VG	SC	191H11-5	952 010 630	4.0mm	4.0mm	-
	40cm/16"	442 040 661	56					191H12-3	-			
DCS43, DCS52, DCS430, DCS431, DCS520	38cm/15"	443 038 651	56	1.3mm/0.050"	3/8"	91VG	SC	523 093 656	952 020 650	5.5mm	4.8mm	-
	45cm/18"	445 045 651	64					523 093 664	952 020 650			
DCS4300i, DCS5200, DCS5200i, DCS6000i, DCS6800i	38cm/15"	443 038 651	56	1.5mm/0.058"	3/8"	73DP	SC	523 093 656	-	5.5mm	4.8mm	-
	45cm/18"	445 045 651	64					523 093 664	-			
	38cm/15"	443 038 651	56					523 093 656	-			
	45cm/18"	191G51-7	64					528 099 664	-			
	60cm/24"	445 060 451 445 060 455	84					528 099 684	952 020 660			
EA6100, EA7900, DCS6400, DCS6401, DCS6400H, DCS7300, DCS7300H, DCS7301, DCS7900, DCS7900H, DCS7901, PS7300, PS7900	45cm/18"	445 045 655	72	1.5mm/0.058"	3/8"	73LP	FC	512 484 772	952 020 650	5.5mm	4.8mm	-
	45cm/18"	445 045 655	68					528 099 668	952 020 650			
	50cm/20"	445 050 655	72					528 099 672	952 020 650			
	60cm/24"	445 060 455	84					528 099 684	952 020 660			
	70cm/28"	445 070 455	94					528 099 694	-			
	60cm/24"	445 060 451	80					528 099 680	-			
	60cm/24"	445 060 451 445 060 455	84					528 099 684	952 020 660			
	70cm/28"	445 070 455	94					528 099 694	-			
DCS9000, DCS9010, PS9010	76cm/30"	443 076 422	92	1.5mm/0.058"	3/8"	73LP	FC	528 099 696	-	5.5mm	4.8mm	-
								522 103 792	-			
EA4301F	45cm/18"	D412 045 661	62	1.3mm/0.050"	3/8"	95VP	SC	531 492 662	-	-	-	Sprocket
		445 045 655	72					512 484 772	-			
DCS430, DCS460, DCS520, 109	45cm/18"	445 045 451 191G51-7	64	1.5mm/0.058"	3/8"	73LP	FC	528 099 664	-	-	-	Solid Sprocket
								73DP	SC			
DCS6000i, DCS6400, DCS6401, PS6400	50cm/20"	445 050 455	72	1.5mm/0.058"	3/8"	73LP	FC	528 099 672	-	-	-	-
DCS520, DCS6000i, 111	53cm/21"	445 053 451 443 053 651	72	1.5mm/0.058"	3/8"	73LP	FC	528 099 672	-	-	-	Solid Sprocket
								-	-			
EA3201S	40cm/16"	191G17-7	56	1.1mm/0.043"	3/8"	90SG	SC	531 291 656	419242-9	4.5mm	4.0mm	-

Chainsaw Accessories

Model No.	Guide Bar				Saw Chain						Bar Cover		Drive sprocket	
	Bar length	Motor Mount	Type	Part No.	No. of drive links	gauge	pitch	Type OREGON / DOLMAR	Cutter type	Part No.	Part No.	Type	Part No.	

Cordless Chain Saws

UC120D,	16cm/ 6-1/4"	-	without Sprocket	158476-6/ 191G59-1	42	1.3mm/ .050"	1/4"	25AP / 466	MC	791284-8	-	Sprocket	221504-1
DUC121, DUC122	16cm/ 6-1/4"	-	without Sprocket	158476-6/ 191G59-1	42	1.3mm/ .050"	1/4"	25AP / 466	MC	791284-8	-	Sprocket	221527-9
DUC204 DUC254 DUC254C	25cm/10"	-	Solid carving bar	1911A1-3	60	1.3mm/ .050"	1/4"	25AP / 466	MC	194098-8	-	-	-
		A041	Sprocket nose bar	191G14-3	40	1.1mm/ .043"	3/8" LP	90PX / 291	CC	191H00-0	-	-	1911W5-9
		A041		168408-5/ 191G22-4	40	1.3mm/ .050"	3/8" LP	91PX / 492	CC	191H04-8	-	-	-
BUC250, UC250D, BUC300, UC300D, DUC252, DUC302	30cm/12"	A041	Sprocket nose bar	191G15-1	46	1.1mm/ .043"	3/8" LP	90PX / 291	CC	191H01-8	-	-	-
	25cm/10"	-	-	1911A1-3	60	1.3mm/ .050"	1/4"	25AP / 466	MC	194098-8/ 191G96-5	-	-	-
	25cm/10"	A041	Sprocket nose bar	168408-5/ 191G22-4	40	1.3mm/ .050"	3/8" LP	91PX / 492	CC	191H04-8	-	Sprocket	221526-1
	30cm/12"	A041	Sprocket nose bar (Micro-Lite)	165245-8	46	1.1mm/ .043"	3/8" LP	90PX / 291	CC	196740-7	-	Sprocket	221497-2
UC002G UC003G UC004G UC006G UC007G UC010G- UC020G	25cm/10"	-	Solid carving bar	A-68600	60	1.1mm/ .043"	1/4"	-	-	191D60-8	-	Sprocket	221497-2
	30cm/12"	A041	Sprocket nose bar	*191T86-6	51	-	-	-	-	*191T90-5	-	-	-
	35cm/14"	A041		*191T87-4	59	1.1mm/ .043"	0.325	80TXL	MC	*191T91-3	-	Sprocket	191V91-5
40cm/16"	A041	*191T88-2		64	-	-	-	-	*191T92-1	-	-	-	
DUC303, DUC353, DUC400	30cm/12"	A041	Sprocket nose bar (Micro-Lite)	165245-8	46	-	-	-	-	196740-7	-	-	-
	35cm/14"	A041		165246-6	52	1.1mm/ .043"	3/8" LP	90PX / 291	CC	531 291 652	-	-	-
	40cm/16"	A041		191G17-7	56	-	-	-	-	196742-3/ 191H03-4	419242-9	-	-
	30cm/12"	A041	Sprocket nose bar	191G23-2	46	-	-	-	-	191H10-7	-	Sprocket	199063-2 / 1911W5-9
	35cm/14"	A041	Sprocket nose bar	191G24-0	52	1.3mm/ .050"	3/8" LP	91PX / 492	CC	191H11-5	-	-	-
40cm/16"	A041	-	191G25-8	56	-	-	-	-	191H12-3	419242-9	-	-	

Electric Chain Saws

UC3041A, UC3541A, UC4041A	30cm/12"	A041	Sprocket nose bar (Micro-Lite)	165245-8	46	-	-	-	-	196740-7	-	-	-
	35cm/14"	A041		165246-6	52	1.1mm/ .043"	3/8"	90PX / 291	CC	191H02-6	-	-	-
	40cm/16"	A041		191G17-7	56	-	-	-	-	191H03-4	419242-9	-	-
	30cm/12"	A041	Sprocket nose bar	-	46	-	-	-	-	-	-	-	-
	35cm/14"	A041		442 035 661	52	1.3mm/ .050"	3/8"	91PX / 492	CC	-	-	-	-
40cm/16"	A041	-	191G25-8	56	-	-	-	-	-	419242-9	-	-	
UC3050A, UC3550A, UC4050A, UC4550A, UC3051A, UC3551A,	30cm/12"	A041	Sprocket nose bar	-	46	-	-	-	-	-	-	-	-
	35cm/14"	A041		191G24-0	52	1.3mm/ .050"	3/8"	91PX / 492	CC	191H11-5	-	Sprocket	221521-1
	40cm/16"	A041		191G25-8	56	-	-	-	-	191H12-3	419242-9	-	-
UC4051A, UC4551A	45cm/18"	A041	-	-	-	-	-	-	-	-	419242-9	-	-

Solid Carving Bar

Part No. 1911A1-3



Saw Chain: 25AP-60 links
Part No. 191G96-5



Drive sprocket: 1/4" 9T

Model No.

DUC204, DUC254, DUC254C, DUC303, DUC353, DUC400, DUC305, DUC355, DUC405
DUC256, DUC306, DUC356, DUC406, DUC256C: 198259-2
DUC252, DUC302, DUC352, DUC252C: 221528-7
UC002G, UC003G, UC004G, UC006G, UC007G: 191V92-3



Outdoor Power Equipment

Bar nut



* Pole saw attachment (196315-2)

Model No.	Thread Size	Wrench Size	Part No.
EA4300F, EA5001P, EA5000P, EA6100P, EA6101P, EA7300P, EA7301P, EA7900P, EA7901P	Single	2	252145-2 923208004

Round File, File holder

For Model:
Chain saw
* with handle



Saw Chain Type	Size	Round File		File and File Handle and File Holder
		Part No.	Q'ty	Part No.
25F, 25AP, 91P, 91PX, 91PXL, 91VXL, M91VXL, 466, 492, 196	4mm	*744003-1	1	-
		953003090	1	953030010
		D-67365	12	D-70948
90PX, 90SG, 291	4.5mm	953003100	1	195923-6
		-	-	D-70954
		-	-	-
95VPX, 95TXL, 20BPX, 21BPX, 22BPX, 20LPX, 21LPX, 22LPX, 082, 086, 686, 484	4.8mm	953003070	1	-
		-	-	D-70960
		-	-	-
72DPX, 73DPX, 75DPX, 72LPX, 73LPX, 75LPX	5.2mm	D-67424	12	D-70976
		-	-	-
72V, 73V, 75V, 72APX, 72DPX, 73DPX, 75DPX, 72EXL, 73EXL, 75EXL, 72EXJ, 73EXJ, 75EXJ, 72LGX, 73LGX, 75LGX, 72JGX, 73JGX, 75JGX, 72JPX, 73JPX, 75JPX, 72LPX, 73LPX, 75LPX, 72RD, 73RD, 75RD, 496, 093, 099	5.5mm	953003040	1	-
		-	-	D-70982
		-	-	-

Pruning extension set

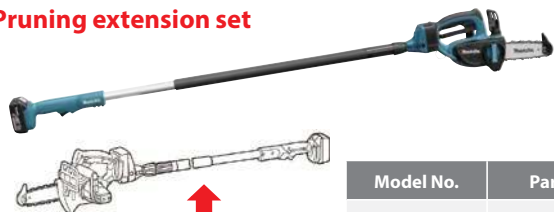

Model No.	Part No.
DUC122	195595-7

Holster For DUC101 & UC100D



Model No.	Part No.
DUC101, UC100D	1911R0-4

Flat File, Depth gauge



Flat file		Depth Gauge		Flat File and File Handle and Depth Gauge
Part No.	Q'ty	Part No.	Part No.	Part No.
953003060	1	953003060	-	-
-	-	-	-	D-70998



File set for in Roll Up Pouch



For all saw chain

Description	Part No.
φ4.0mm Round File(3pcs) / File Holder / Flat File / Handle(2pcs) / Depth Gauge	D-72154
φ4.8mm Round File(3pcs) / File Holder / Flat File / Handle(2pcs) / Depth Gauge	D-72176
φ5.2mm Round File(3pcs) / File Holder / Flat File / Handle(2pcs) / Depth Gauge	D-72182
φ5.5mm Round File(3pcs) / File Holder / Flat File / Handle(2pcs) / Depth Gauge	D-72198

Chain oil

Description	Size	Part No.
Chain Oil	100ml	182229-1
 <p>With Makita chain oil, chain oiling is formulated to adhere to the bar and chain and to reduce wear. Adhesion additive helps keep sap and pitch from clinging to the bar and chain. (Not available in Austria)</p>		
BIOTOP Chain oil	1L	980008610 1910U0-9
 <p>With BIOTOP, chain oiling is safe for environment. BIOTOP is purely vegetablebased and readily biodegradable. It meets the strict requirements of the RAL UZ48 environment mark for environmental compatibility, lubrication, and aging resistance.</p>		

Outdoor Power Equipment

Hook holder for extension cord



Model No.	Description	Part No.
B	Cord holder complete set	194677-2
C	Hook complete	158024-1

Shear blade & Blade cover for Grass Shear



Model No.	Cutting Width	Blade Assembly	Blade cover	Grass Receiver
DUM111, DUM110	110mm	191N23-4	413885-9	454880-0
DUM168, DUM604, UM600D, UM603D	160mm	195267-4	452055-5	457426-1

Conversion from Hedge Trimmer to Grass Shear

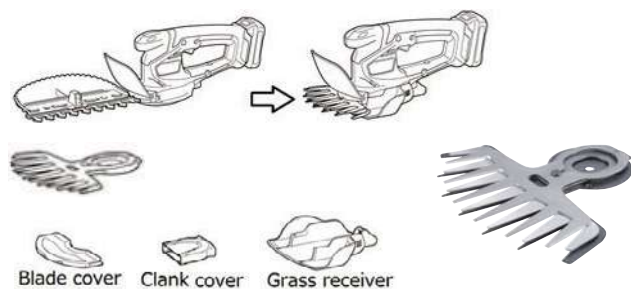

Model No.	Cutting Width	Blade assembly
UH201D	160mm	195267-4

Grass Receiver



*with grass Shear blade

Model No.	Part No.
DUM604, UM600D, UM603D, *UH201D	457426-1

Blade type

A: Curving blade

Optimum blade shape for smooth cutting

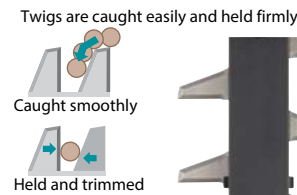
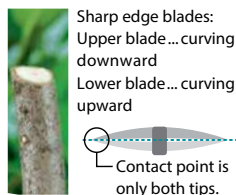

B: High grade blade

Upper/ Lower blade teeth with 3

sharpened edges for clean cut.



Blade teeth with 3 sharpened edges. Well sharpened edges provide clean cut with the least branch damage.

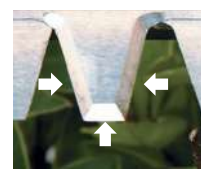

C: Stain-free blade

Non-electrolyzed nickel plating

Evenly and strongly adhered surface coating that features high anti-abrasion surface for long lasting coating.



Sap on the blade (after 10 hour trimming of Boxwood)

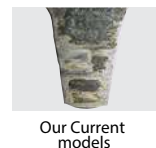

Cordless Hedge Trimmer

*for China, Hong Kong, Korea, Malaysia, Philippines, Singapore, Taiwan & Vietnam.

**for Canada & Mexico

Model No.	Blade Assembly		Blade Cover
	Blade Type	Part No.	Part No.
UH201D	C	EU:198408-1	458342-0
DUH551	C	196687-5	450489-6
DUH651	C	196688-3	450490-1
DUH506	C	1910H8-2	-
DUH606	C	1910H9-0	-
DUH507	C	1911J1-6	-
DUH521, DUH523U, UH520D, UH522D	C	195769-0	-
DUH501	A	-	458413-3
DUH601	A	199099-1	458414-1 *459121-9
DUH751	A	199100-2	458415-9
DUH604S	B	191D38-1	-
DUH754S	B	191D39-9	-
DUH502	B	199598-3	459120-1
DUH502	B	**199236-7	**459120-1
UH004G	A	191R53-9	-
UH005G	A	191R54-7	-
UH006G	A	191R55-5	-
UH007G	A	191R56-3	-
UH008G	B	191R57-1	-
UH009G	B	191R58-9	-
UH014G	B	191Y05-2	-

Outdoor Power Equipment

Model No.	Blade Assembly		Blade Cover
	Blade Type	Part No.	Part No.

Pole Hedge Trimmer (Cordless, Petrol, Multi-tool attachments)

*with Blade guard

**without Blade guard

DUN461W, UN460WD	A	191P00-8	-
DUN500W	A	191C14-9	458413-3
DUN600L	A	191C13-1	-
EN420MP	B	198195-2	-
EN401MP, EN410MP, EN4950H, EN4951SH	B	197763-8 EU:197768-8	-
EN5950S	B	**126281-9	-

AC Hedge Trimmer

UH5580	C	194671-4	-
UH6580	C	194673-0	-
UH6570	C	194666-7	-
UH7580	C	194675-6	-

Petrol Hedge Trimmer

*for blade without end cover

**for blade with end cover

EH5000W	B	123709-8	-
EH6000W	B	196797-8	-
EH7500W	B	125857-9	-
EH6000S	B		-
EH7500S	B	125773-5	-

Chip receiver assembly set

Keeps branch or leaf debris from scattering around.

• Attachable to either side of the blade



Model No.	Description	Part No.
DUH202, *DUM111, *DUM604, UH201D, *UM110D, *UM600D, *UM603D	One-touch installation removal	198401-5
DUH483, DUH523, UH4261, UH4861, UH5261	With binding head screw M5X12 x 5pcs	195050-9
DUH501, DUH502, DUH601, DUH602, DUH751, DUH752	One-touch installation/removal	199151-5
DUH502, DUH602, DUH752	One-touch installation/removal	199152-3**
DUH604S	-	191D33-1
DUH754S	-	191D34-9
UH004G, UH006G, UH008G	-	191R51-3
UH005G, UH007G, UH009G	-	191R52-1

Toothed edge

designed like saw teeth can catch and prevent leaf or twig debris from falling over the edge of chip receiver.



Anti-slide ribs on the bottom plate prevents leaf or twig debris from sliding and slipping out of chip receiver.

Model No.	Description	Content	Part No.
EH7500S, EN7350S	without blade guard	With binding head screw M5X12 x5pcs	196777-4
EH7500S, EN7350S	with blade guard	With binding head screw M5 x 12 x 5pcs.	195321-4

Conversion from Grass Shear to Hedge Trimmer

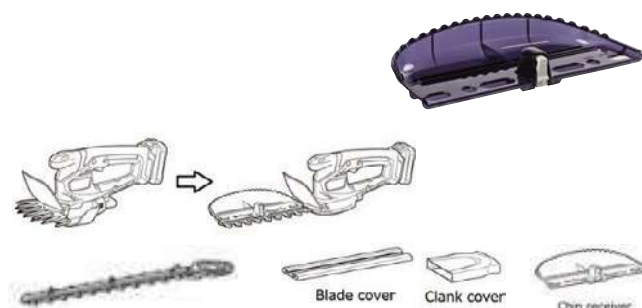

*With clank cover

Model No.	Blade Assembly	Blade Cover	Chip Receiver
	Part No.	Part No.	Part No.
DUM604, UM600D, UM603D	198408-1	*195274-7	198401-5
DUM110, DUM111	191N24-2	458342-0	198401-5
		*195274-7	

Blade guard



Model No.	Part No.
Cordless Hedge Trimmer	
DUH501, DUH502, DUH601, DUH602, DUH751, DUH752	458408-6

Long attachment handle (Extension handle kit)

Photo:198486-1



*with grass shear blade

Model No.	Part No.
DUM604, *DUH202, UM110D, DUM111, UM600D, UM603D, *UH201D	EU:198486-1

Outdoor Power Equipment

Pruning Shear blade

Shear blade (U)



Do not re-use Stop Ring E-4 when reassembling.

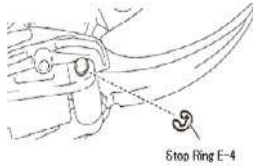

Shear blade (L)

Do not re-use Stop Ring E-4 when reassembling.
Stop Ring E-4

*With Stop Ring E-4 (P/N:961011-9)

**Hex socket button head screw M3x6 P/N:266183-8

& Shoulder bolt M8

P/N:251573-8 are also necessary.

Model No.	Type	*ShearBlade (U)	Shear Blade (L)
		Part No.	Part No.
DUP361 DUP362	Standard	EU: 197588-0*	EU: 197367-6
	For hard branch	-	199169-6
	For thin branch	199314-3**	-

Branch catcher set

*with Shear blades for thin branch

Branch catcher set



Model No.	Part No.
*DUP361, *DUP362	199311-9

Diamond file for shear blade

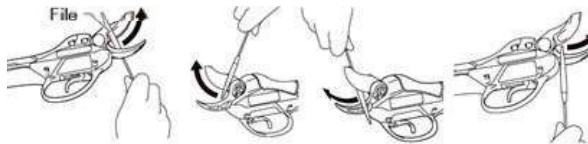

Model No.	Part No.
DUP361, DUP362	794530-8

Wheelbarrow attachment

Dump unit set
DCU603 & DCU604



Carrier set
DCU180



DCU604



Bucket set
DCU180



DCU603



DCU605

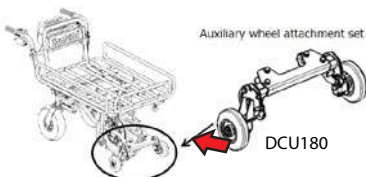

DCU180

Model No.	Type	Part No.
DCU180	Carrier set (Pipe deck)	199116-7
	Bucket set	198494-2
	Auxiliary wheel attachment set	191A01-6

Wheelbarrow attachment

Model No.	Type	Part No.
DCU603	Dump Bucket 200 Set	191B69-8
DCU604	Carrier Set	191B67-2
DCU605	Flat Bucket Set	1911B3-6
DCU603, DCU604	Dump Unit Set	191B63-0

Tire for Wheelbarrow



Model No.	Type	Part No.
DCU603, DCU604, DCU605	Tire 330 (Single) Set	1911K4-7
	Gray Tire 330 (Single) Set	1911K5-5
	Gray Tire 210 (Single) Set	1911K6-3

Rotary lawn mower blade



Model No.	Size (mm)	Part No.
Cordless Lawn Mower		
DLM382	380	191D41-2
DLM432	430	191D43-8
DLM460, DLM461, DLM463, DLM464	460	199367-2
DLM462, DLM465	460	191D51-9
DLM530, DLM531, DLM532, DLM536, DLM537, LM001C	530	191D52-7
Electric Lawn Mower		
ELM3320	330	YA00000745
ELM3720	370	YA00000746
ELM4121	410	YA00000738
ELM4620	460	YA00000741
ELM4621	460	YA00000741
Petrol Lawn Mower		
PLM4120N	410	671001433
PLM4620N2, PLM4621N2, PLM4622N2, PLM4626N, PLM4627N, PLM4628N, PLM4630N2, PLM4631N2, PLM4632N	460	DA00001274

Rotary lawn mower swing back blade



Model No.	Swing Back Blade Set		Replacement Blade Set	
	Size (mm)	Part No.	Size (mm)	Part No.
DLM462, DLM465	460	191D49-6	4	191D47-0
DLM530, DLM531, DLM532, DLM533, DLM535, DLM536 DLM537, LM001C	530	191D50-1	4	191D48-8

Outdoor Power Equipment

Mulching plug set



Model No.	Part No.
DLM382 DLM432	191D46-2

Vacuum Attachment



Model No.	Description	Part No.
DUB363	Vacuum kit set	191E19-1
BHX2500, BHX2501	Vacuum set	195282-8

Pipe, End pipe, Flat nozzle & others accessory

*Adapter pipe 71 set are also necessary.
 **Adapter pipe 80-72 set are also necessary.
 ***Adapter pipe 85-72 set are also necessary.
 ****Adapter pipe set MG set are also necessary.

Model No.	Items	Part No.
DUB184** DUB362 DUB363 UB001C*** UB001G**** UB400MP****	Extension Nozzle 	197888-8
	Flat nozzle 	197889-6
DUB184** DUB362* DUB363 UB001C*** UB001G**** UB400MP**** UB401MP****	Gutter nozzle set (2.9m) • Extension Pipe 72 0.9m P/N:459816-4) x3 • Nozzle P/N:162790-4) x1 • Hose Clamp 75-90 P/N:281030-2) x2 • Hose Clamp 85-100 P/N:281031-0) x1 	191B03-8
DUB362	Adapter pipe 71 set 	191J13-3
DUB184	Adapter pipe 80-72 set 	191L13-5
UB001C UB001G	Adapter pipe 85-72 set 	191L96-5
UB400MP UB401MP	Adapter pipe set MG 	191C15-7
UB001G DUB184 DUB362	Shoulder belt 	166094-6



Pipe



End nozzle



Flat nozzle



Hip belt



Sternum strap



Model No.	Items	Part No.
EB5300TH, EB5300WH, EB7660TH, EB7660WH	Long pipe 90 set	197723-0
	Short pipe 90 set	196912-4
	End nozzle 90-62	198034-6
	Flat nozzle	196911-6
PM7650H, PM7651H	Top adapter	453986-1
BHX2500, BHX2501	End Pipe (Flat nozzle)	451753-8

Nozzle assembly

A: Standard equipment



Model No.	Size (mm)	Type	Part No.
DUB182	220	A	132025-7
UB100D, UB101D, DUB185, DUB186	220	A	123245-4
	430	-	123246-2

Tapered Nozzle

A: Standard equipment

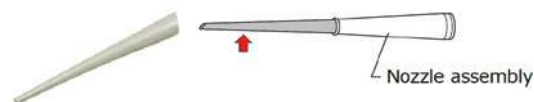

Model No.	Color	Part No.
UB100D, UB101D, DUB185, DUB186	Gray	192236-6

Bending long nozzle set

* long nozzle



Model No.	Part No.
DUB183	TP00000199
UB100D, UB101D, DUB185, DUB186	191G09-6

Dust Bag



Model No.	Part No.
UB100D, UB101D, DUB185, DUB186	123241-2

Flexible hose set











(Total length: 95cm)







Model No.	Part No.
DUB185, DUB186, UB100D, UB101D	196643-5

Outdoor Power Equipment

Sprayer accessories for EF1550RH & EVH2000

Shape	Model No.	Features/ Recommended use	Part No.	
Wide angle herbicide nozzle 	EF1550RH EVH2000	for spraying herbicides; also ideal for watering plants or spraying soil conditioner	6908031000	
Herbicide nozzle 		Hard to become mist preventing diffusion of medicine.	6958011000	
Y-shaped double nozzle 		for general pesticide applications using insecticides, fungicides, etc.	6958025000	
Long two head nozzle 		Wide spraying with wide angle outlet.	6949001000	
U-shaped double nozzle 		Wide spraying with wide angle outlet.	6958018000	
Triple concentric nozzle 		Spraying in the form of circular.	6909500100	
Quadruple concentric nozzle 		Spraying in the form of circular.	6919500000	
Compact nozzle 		Convenient for spraying in the green house by compact nozzle.	6939025000	
Jet nozzle 2 		EVH2000	Diffusion or straight is selectable with one tach	6939024000
Super jet nozzle 			Diffusion or straight is selectable.	6939028000

Power washer accessories for DHW080, HW1200, & HW1300

Shape	Model No.	Part No.
Trigger gun set 	DHW080 HW1200 HW1300	197842-2
Variable nozzle set 	DHW080 HW1200 HW1300	197822-8
Variospray lance set 	DHW080 HW1200 HW1300	197876-5
Cyclone jet nozzle set 	DHW080 HW1200 HW1300	197824-4
Cyclone guard set 	DHW080 HW1200 HW1300	197864-2
Under body spray lance set 	DHW080 HW1200* HW1300* (**for 110-127V)	197859-5
	HW1200** HW1300** (**for 220V-240V)	198909-9
Extension pipe set (0.9m / 1.3m / 1.7m) 	DHW080 HW1200 HW1300	197870-7

Shape	Model No.	Part No.	
Trigger gun set 	DHW080 HW1200 HW1300	197842-2	
Rotating brush set 	DHW080 HW1200 HW1300	197831-7	
Wash brush set 	DHW080 HW1200 HW1300	197828-6	
Foam nozzle set 	DHW080 HW1200 HW1300	197886-2	
Pipe cleaning hose 	DHW080 HW1200 HW1300	10m	197837-5
		15m	197840-6
High pressure extension hose 	DHW080 HW1200 HW1300	5m	197845-6
		8m	197847-2
		10m	197850-3
Twist prevention joint set 	DHW080 HW1200 HW1300	197867-6	
Self-suction hose set 	DHW080 HW1200 HW1300	197873-1	
Accessory joint set 	DHW080 HW1200 HW1300	197853-7	
Absorption connector set 	DHW080 HW1200 HW1300	197881-2	
One touch joint set 	DHW080 HW1200 HW1300	197883-8	
Cleaner pin set 	DHW080 HW1200 HW1300	197879-9	
Shoulder belt 	DHW080	162523-7	



Outdoor Power Equipment

Spark plug



Model No.	Wrench Size (mm)	Part No.
NGK CMR4A	16	168534-0
NGK CMR6A	16	168401-9
NGK CMR6H	16	168652-4
NGK CMR7A-5	16	168599-2
NGK BPMR7A	19	168648-5
NGK BPM7A	19	168588-7
NGK BPMR8Y	19	649500-1
NGK BMR7A	19	168662-1

High-performance 2-stroke engine oil 50:1



Model No.	Part No.
100ml	980008606
1L	980008607

Fuel mixture



Model No.	Part No.
1L	456236-3

Grease vessel set



Description	Size	Part No.
For Pole hedge trimmer and Multi-tool attachments (Cultivator, Power brush and Power sweep) (GREASE NO.0)	80ml	197439-7
For string trimmer, Brushcutter and Hedge trimmer (GREASE NO.2)	80ml	199450-5



ACCESSORIES

▣ Cleaning / Vacuum System









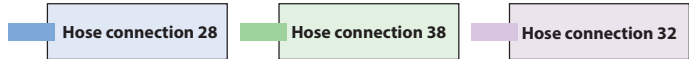

























Vacuum Cleaner System charts











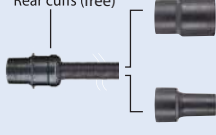

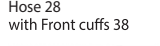

For Dust Collecting

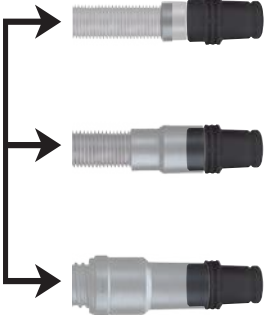
*for Model DVC261, DVC265, DVC660, DVC665 only



Model VC002GL VC004GL DVC157L DVC867L		Model VC3211H VC3211M VC2211M VC3210L VC2510L VC1310L		Model VC009G DVC265 DVC665 DVC350		Model DVC750L		Model VC3012L/M VC4210L/M		Model VC2012L VC2512L VC3011L	
Hose 28mm 1.0m *143787-2 without front cuffs 1.5m A-34235 with front cuffs 22, 38 2.5m 195437-5 with front cuffs 22, 24, 38 3.5m 195433-3 with front cuffs 22, 24, 38 5.0m 195436-7 with front cuffs 22, 24, 38 5.0m A-34229 with front cuffs 22, 38				Hose 38mm with front cuffs 38 1.5 198757-6 2.5 195434-1 5.0 195435-9				32-B Hose 32mm 4m P-84084			
Front cuffs Front cuffs 38 195545-2				Front cuffs 24 195546-0				Front cuffs 22 195547-8			
				Joint 22-38 195548-6				Front cuffs 24 195546-0			
								Tool adaptor Quicksystem ø24 (set) P-70378 Quicksystem ø38 (set) W107418688			
								Tool adaptor Quicksystem ø24 (set) P-70378 Quicksystem ø38 (set) W107418688			
Attachments 											
		Wireless unit adapter 		WUT02 Converts tool-triggered AC vacuum cleaners in the market into AWS-compatible vacuum cleaners							

Front cuffs, Joint & Hose Connection

Hose 28mm Supplied with both Front cuffs 22 and 38 	Rear cuffs (free) 	Front cuffs 38: Inner dia. 38.0mm, Outer dia. 44.2mm Front cuffs 22: Inner dia. 22.4mm, Outer dia. 25.0mm												
Hose 38mm 	Rear cuffs (free) 	Front cuffs 38: Inner dia. 38.0mm, Outer dia. 44.2mm												
Front cuffs 38, Front cuffs 22 and Front cuffs 24 connection Hose 28 with Front cuffs 22 			Hose 28 with Front cuffs 38 			Hose 38 with Front cuffs 38 			Front cuffs 24 					
Hose to hose connection Hose 28 with Front cuffs 38 			Hose 38 with Front cuffs 38 			Hose 28 Rear cuffs 			Hose 38 Rear cuffs 					
Joint 22-38 connection & size Hose with Front cuffs 38 			Joint 22-38 			Size: Inner dia. 22.4mm, Outer dia. 25.0mm 								

System Charts

A



W/ Ø28mm Hose

Model
VC002GL / VC004GL VC3211H / VC3211M VC008G / VC009G DVC350
DVC157L / DVC867L VC2211M / VC3210L DVC660 / DVC665
VC2510L / VC1310L DVC261 / DVC265

W/ Front cuffs



38 24 22

B



W/ Ø38mm Hose

Model
VC001GL / VC003GL VC005GL / DVC155L DVC156L / DVC860L DVC861L / DVC865L DVC866L / DVC750L

W/ Joint 22-38





C



W/ Ø32mm Hose

Model
VC2012L / VC2512L VC3011L / VC2000L

W/ Tool adapter Adapter 38 (option)

24  **38** 

P-81745 P-70421



D



W/ Ø32mm Hose

Model
VC3012M / VC3012L VC3011L / VC4010L VC4010M / VC4010L

W/ Tool adapter

24  **38** 

P-70378 W107418688

Demolition hammer & Rotary hammer



A
B

Front cuffs
22 or 38

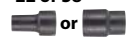

C
D

Tool adapter 24





A
B

Front cuffs
22



C
D

Tool adapter
24



*grip base for dust cup is also necessary
**With Sensormatic chip

Model No.	Operation mode	Vacuum Attachment Set		Cuffs Size
		Type	Part No.	
Electric breaker	---	W / Hose	191M20-4	Cuffs 24 or cuffs 38
	---	W/o Hose	197168-2	Hose 28 without cuffs
	---	W / Hose	197148-8	Cuffs 24 or cuffs 38
Rotary Hammer	Drilling Hammer	-	197148-8	Cuffs 22
	Drilling Hammer	-	196858-4	Cuffs 22
	Drilling Hammer	-	196074-8	Cuffs 22
Rotary Hammer	Drilling	Dust collector set	193472-7	Cuffs 22
	All	Dust cup set	198362-9	Cuffs 22
	All	Dust cup set	195173-3	Cuffs 22
Rotary Hammer	All	Dust cup set	195179-1	Cuffs 22

Items of standard equipment and specifications may vary by country or area.

System Charts

Circular saw and Plunge Cut Circular Saw

*Inner flange is also necessary.
**with shortlever



A
B
Front cuffs
22 or 38
or

C
D
Tool adapter
24 +
Joint 25-50
192349-3
or
Tool adapter
24*

* not needed
Front cuffs 24



Model	Dust nozzle set and Joint set		Cuffs Size
	Type	Part No.	
DHS630	Dust nozzle set	194314-8	Cuffs 22
DHS660, DHS661	Dust nozzle set	199230-9	Cuffs 24
HS012G, DHS680	Dust nozzle set	196961-1	Cuffs 24
DHS710	Dust nozzle set	196520-1	Cuffs 24
DHS711	Dust nozzle set	196843-7	Cuffs 24
DHS780, DHS781, DHS782, DHS783	Dust nozzle set	196520-1	Cuffs 24
HS009G, HS010G, HS011G	---	---	Cuffs 24
DHS900, DHS901, DSP600, DSP601	---	---	Cuffs 24
DSS501	Dust nozzle set	194415-2	Cuffs 22
5008MG, 5008MGA	Dust nozzle set	194489-3	Cuffs 38
N5900B, 5902B	Joint set	193068-4 / 193823-4	Cuffs 38
HS003G/HS004G	Dust nozzle set	196520-1	Cuffs 24
HS301D	Dust nozzle set	452237-9	Cuffs 22
HS0600	Dust nozzle set	198263-1 / 198265-7	Cuffs 24
HS6600	Dust nozzle set	196843-7 / 196520-1	Cuffs 24
HS7010	Dust nozzle set	196520-1	Cuffs 24
HS7600	Dust nozzle set	197221-4 / 196520-1	Cuffs 24
SP6000, SP001G	---	---	Cuffs 24

Angle grinder to diamond wheel

*Inner flange is also necessary.



A
B
Front cuffs
22 or 38
or

C
D
Tool adapter
24

Model	Dust collection wheel guard for diamond wheel		Cuffs Size
	Type	Part No.	
100mm Single notch bearing box models	A	198413-8	Cuffs 22
	C	199295-1	Cuffs 38
9500NB N9500N	C + Rubber sleeve	192212-0 + 192202-3	Cuffs 22
125mm Triple notches bearing box models	A	198416-2	Cuffs 22
	B	192968-5	Cuffs 38
125mm Single notch bearing box models	C	196846-1	Cuffs 38
	C	191G06-2	Cuffs 38
125mm Toolless wheel cover (Slide lever style) models	C	191G06-2	Cuffs 38
180mm Triple notches bearing box without brake models	D	198514-2 (M14 spindle)	Cuffs 38
180mm Twin notches bearing box models & Single notch bearing box models	B	194303-3	Cuffs 38
230mm Triple notches bearing box without brake models	D	198440-5(EU)	Cuffs 38
230mm Twin notches bearing box models & Single notch bearing box models	B	194044-1	Cuffs 38
	D	198380-7 (M14 spindle)	Cuffs 38
230mm Single notch bearing box models	B	194044-1	Cuffs 38





















Angle grinder to cup diamond wheel





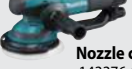

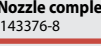







Model	Diamond wheel Dust collection wheel guard for cup		Cuffs Size
	Wheel Size	Part No.	
125mm Toolless wheel cover (Slide lever style) models	125mm	191F81-2	Cuffs 38
125mm Triple notches bearing box models	125mm	195239-9(EU)	Cuffs 38
125mm Single notch bearing box models	125mm	195237-3	Cuffs 38
230mm twin notches bearing box models	180mm	195388-2	Cuffs 38

Items of standard equipment and specifications may vary by country or area.

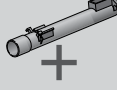
System Charts

For Model	Suction Systems and Part No.	
Belt Sander 9032, DBS180 	Dust nozzle assembly 122652-8 	
Belt Sander 9031 	<div style="border: 1px solid black; padding: 5px; margin-bottom: 5px;"> A Front cuffs 22  </div> <div style="border: 1px solid black; padding: 5px; margin-bottom: 5px;"> B Front cuffs 22-38 195548-6  </div> <div style="border: 1px solid black; padding: 5px; margin-bottom: 5px;"> C Tool adapter 24 + Joint 25-50 192349-3 or Tool adapter 24*  </div> <div style="border: 1px solid black; padding: 5px;"> D Tool adapter 38 + Joint 22-38 195548-6 or Tool adapter 24*  <p><small>* not needed Front cuffs 24</small></p> </div>	
Finishing Sander 9046, BO3700, BO3710, BO3711, BO4900/V, BO4901, BO4555, BO4556, BO4565, BO4566, BO4557, BO4558  		
Random Orbit Sander BO5012, BO5030, BO5031, BO5040, BO5041, BO6030, BO6040, DBO180 		
Multi Tool DTMS2 ————— 191R02-6 DTMS1 ————— 199627-2 DTMS0 ————— 199621-4 TM3000C ————— 199618-3 TM3010C ————— 199624-8 	Dust attachment set 	
Belt Sander 9404, 9902, 9903, 9910, 9911, 9920, 	<div style="border: 1px solid black; padding: 5px; margin-bottom: 5px;"> A Front cuffs 22  </div> <div style="border: 1px solid black; padding: 5px; margin-bottom: 5px;"> B Front cuffs 22-38 195548-6  </div> <div style="border: 1px solid black; padding: 5px; margin-bottom: 5px;"> C Tool adapter 24 + Joint 25-50 192349-3 or Tool adapter 24*  </div> <div style="border: 1px solid black; padding: 5px;"> D Tool adapter 38 + Joint 22-38 195548-6 or Tool adapter 24*  <p><small>* not needed Front cuffs 24</small></p> </div>	
Random Orbit Sander BO6050 		Front cuffs24 195546-0 
Nozzle complete 143376-8 		
Cordless Drywall Sander DSL800, DSL801 		Front cuffs24 195546-0 

For Model	Suction Systems and Part No.
Jig Saw JV100D, JV143D, JV183D, 4326, 4327, 4328, 4329, JV0600 	<div style="border: 1px solid black; padding: 5px; margin-bottom: 5px;"> A Front cuffs 22  </div> <div style="border: 1px solid black; padding: 5px; margin-bottom: 5px;"> B Front cuffs 22-38 195548-6  </div>
Jig Saw DJV180, 4350T/CT/FCT, 4351T/CT/FCT  	Dust Nozzle 417853-4 
Cordless Jig Saw DJV181, DJV182, **JV102D, JV103D  	Dust nozzle assembly 126331-0, 457801-1  Front cuffs 24 195546-0 
Cordless Cutter DCSS53 	Dust cap complete 



Items of standard equipment and specifications may vary by country or area.

System Charts

For Model	Suction Systems and Part No.
Angle Cutter 4112H 4112HS 4114 4114S	Elbow joint 32 192613-2
Dustless Cutter 4100KB	
Cordless Dustless Cutter DCC500	
Wall Chaser SG1251, SG1250	
Concrete Planer PC5000C, PC5001C PC5010C	
Belt Sander 9924DB	Joint 32 192518-6
Belt Sander 9403, 9921	Joint 32 192349-3

- A**
Front cuffs
38
- B**

- C**
Front cuffs
38
- D**
Tool adapter
38

For Model	Suction Systems and Part No.
Cordless Slide Compound Miter Saw DLS713 DLC714	
Slide Compound Saw LS0714/F/FL/L LS0815F/FL LS1016L LS1017L LS1018/L LS1216/L	
Miter Saw LS1030N, LS1440	
Compound Miter Saw LS1040/F, LS1045, LS1221	
Cordless Compound Miter Saw DLS600	
Flip Over Saw LF1000	
Table Top Miter Saw LH1040/F LH1201FL	
Slide Compound Saw LS1019/L, LS1219/L	Front cuffs 24 195546-0
Cordless Slide Compound Miter Saw DLS110, DLS111, DLS112 DLS211, DLS212	

- A**
Front cuffs
38
- B**













- C**
Front cuffs
38
- D**
Tool adapter
38

*Except model:
VC008G / VC009G
DVC660 / DVC665
DVC261 / DVC265

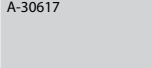

Items of standard equipment and specifications may vary by country or area.

System charts

For Model	Suction Systems and Part No.
Table Saw 2704N, 2705 	Joint 419093-0 
Table Saw 2703 	Joint 55 192799-2 
Table Saw MLT100N 	Dust port JM27000090 
Table Saw 2712 	
Band Saw LB1200F 	Joint 419093-0 
Scroll saw SJ401 	Rubber sleeve 36-38 A-30617 
Planer 2012NB 	Hood set 193036-7 Outer dia. 76 mm 

A
Front cuffs
38*











*Except model:
VC008G / VC009G
DVC660 / DVC665
DVC261 / DVC265
DVC350

B

C
Front cuffs
38

D
Tool adapter
38

For inner dia. 76 mm
Hose Vacuum Cleaner

For Model	Suction Systems and Part No.
Power Planer DKP181 KP0810/C 	
Power Planer DKP180, KP0800 	Nozzle 451329-1 
Power Planer 1805N 	Chip cover 415452-6 
Power Planer 1911B 	Nozzle for vacuum cleaner 192082-7 
Power Planer N1900B, N1923B, KP0800, 1804N 1805N, 1806B, KP312/S 	 + 

A
Front cuffs
38*

*DVC350
Cannot be used
with Planer models

B

C
Front cuffs
38

D
Tool adapter
38



Nozzle assembly



Joint









*Elbow















Model No.	Part No.	Model No.	Part No.
KP0800, DKP180, DKP140	451329-1	DKP180, DKP181, KP0810/C, KP0800	*191C20-4
1805N	JPA122277	1804N, 1805N, 1806B, KP312/S	181575-9

Items of standard equipment and specifications may vary by country or area.

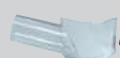
System Charts

For Model	Suction Systems and Part No.
Plate Joiner PJ7000 DPJ180 	
Cut-out Tool 3706 	Dust collection cover 193449-2 
Cordless Cut-out Tool DCO180 DCO181 	
Cordless Drywall saw DSD180, SD100D 	
Router RP0910, RP1110C 	
	A Front cuffs 22* 
	*DVC350 Cannot be used with Router models
	B Front cuffs 22-38 
	195548-6
	C Tool adapter 24  + Joint 25-50 192349-3 
	D Tool adapter 38  + Joint 22-38 195548-6 

*C: DVC350 Cannot be used with Router models

For Model	Suction Systems and Part No.
Router RP1802/ F, RP1803/ F, RP1801/ F, RP1800/ F, RP2302FC, RP2303FC RP2301FC, RP2300FC 3612BR 	Dust nozzle 194934-8 
Router RD1101, RF1101, RP1101 	Dust nozzle 192035-6 
Router RP0900, **RT0700C, ***RT0702C Cordless Router **RT001G, **DRT50 	Dust nozzle 194733-8 
*** Use with Plunge base assembly	
Trimmer RT0700C 	Dust nozzle 195559-1 
Cordless Trimmer RT001G, DRT50 	
	A Front cuffs 38 
	B 
	C Front cuffs 38 
	D Tool adapter 38 

Makita recommend to use 38mm hose when you use Router



Items of standard equipment and specifications may vary by country or area.

Vacuum Cleaner System Charts

For Cleaning

*for Model DVC261, DVC265, DVC660, DVC665 only

with front sleeve

Hose connection 28

Hose connection 38

Hose connection 32

Model VC006GM DVC860L VC003GL DVC861L DVC150L DVC865L DVC151L DVC866L DVC155L DVC867L		Model VC3211H VC3211M VC2211M VC3210L VC2510L VC1310L		Model VC008G DVC261 DVC265 DVC660 DVC665 DVC350	
---	---	--	---	--	--

Cleaning set

- Hose complete 38-2.5
- Straight pipe
- Bending pipe
- Nozzle assembly
- Corner nozzle
- 195439-1



Hose 38mm
with front sleeve (front cuffs 32A)
1.5m 199388-4



Hose 32mm with front sleeve
(front cuffs 32A)
1.0m*199453-9 1.7m 199493-7



Hose 28mm
1.0m *143787-2 5.0m A-34229
1.5m 144408-9
1.5m 152992-0
2.5m 195437-5
3.5m 195433-3
5.0m 195436-7



Hose 38mm
1.5m 198757-6
2.5m 195434-1
5m 195435-9



Bent pipe 192562-3
Straight pipe 192563-1



Bending pipe assembly with pipe lock
without sleeve (front cuffs 32A)
140G26-3



Bending pipe assembly with pipe lock
with sleeve
127093-3



Bending pipe assembly
without sleeve 458184-2
(front cuffs 32A)



Bending pipe assembly
with sleeve 126756-8



Front cuffs 22
195547-8



38mm Tip attachments

Nozzle assembly
Flat type (Dry)
199455-5

F/C switching t-nozzle
Flooring & carpet (Dry)
198184-7

Universal type
(Dry/ Wet)
195551-7

Compact type A (Dry)
195549-4

Compact type B
(Wet model only)
195550-9

Wide Type
(Wet model only)
A-47846

Round brush
191657-9

Corner nozzle
410306-2



Cyclone attachment set with pipe lock*

- 191D71-3
- 191D73-9



Cyclone attachment set*

- 199491-1
- 191D75-5



Aluminum joint pipe (L=465mm)
199844-4



Aluminum straight pipe 32
(L=465mm)
199843-6

for others vacuum cleaner nozzles 32mm (1-1/4")

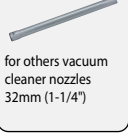

Tapered nozzle set
192236-6



Straight pipe with pipe lock
Aluminum Telescopic pipe 28L
(L=590-942mm) 140G19-0
Bending pipe assembly with pipe lock (140G26-3) set 191B15-1



Plastic Telescopic pipe 28L
(L=590-950mm) 127605-2



Plastic straight pipe 28L with pipe lock
(L=479mm)
○ 459353-8
● 459356-2
● 458942-6

Plastic straight pipe 28L with pipe lock
(L=340mm)
for Cyclone attachment set
○ 191D76-3
● 191D78-9
● 191D77-1

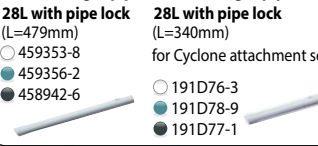

Straight pipe
Plastic Telescopic pipe 28
(L=500-850mm)
123584-2



Plastic straight pipe 28
(L=465mm)
○ 451424-7
○ 451241-5
● 451244-9
● 456587-4

Plastic straight pipe 28 (L=320mm)
for Cyclone attachment set
○ 191D79-7
● 191D81-0
● 191D80-2

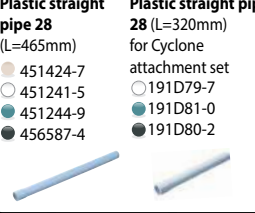

28mm Tip attachments

Nozzle assembly
Flat type
199454-7

F/C switching t-nozzle 28
Flooring & carpet
191G86-8

F/C switching t-nozzle 28
Flooring & carpet
○ 198183-9 / 198532-0
● 199431-9

Nozzle assembly
Floor t-nozzle 28
○ 123485-4
○ 123486-2
● 123488-8
● 123539-7

Floor/carpet t-nozzle
For rug / carpet
○ 198150-4 / 198149-9
○ 198525-7 / 198528-1
● 198523-1 / 198527-3
● 198526-5 / 198529-9

Nozzle assembly
For rug / carpet
122291-4



Seat nozzle 28
For automobile
○ 199038-1
○ 199041-2
● 199039-9

Seat nozzle 120 set
For automobile
140H95-0

Mat nozzle 120
For automobile
459056-4

Brush brush set
191M30-1

Sash nozzle
○ 416041-0
○ 451240-7
● 451243-1
● 456586-6

Corner nozzle 330
○ 198919-6
● 198990-0
● 198992-6

Crevice nozzle 415
199439-3



Round brush
○ 198552-4
○ 198877-6 / 198878-4
● 198549-3 / 198553-2
● 198555-8

Shelf brush
○ 198537-0
○ 198873-4
● 198538-8
● 198540-1

Soft brush 360 complete set
140H94-2

Rubber nozzle 330 set
*422437-5

Flexible rubber nozzle 28
*197900-4 / 197901-2

***These nozzles cannot be attached directly to Bending pipe assembly use with telescopic pipes or straight pipes.**



Model VC2000L



Hose 32mm
2.5m
P-81739



Extension tubes
ø35x520mm black 2 pcs
P-72942



Floor nozzle
D36x260
(Dry/ Wet)
W107402706

Floor nozzle
Universal Type (Wet)
W000014295

Corner nozzle
ø35x200
Use with P-81745
W000029541



Filter & Dust bag



for Dust (Powder)

- Powder Filter Set
- Damper set
- Pre-filter set
- Dust paper filter or Poly bag set

for Wet & Dry

- Cloth filter or Water filter (Water only)

Compatible with usual Poly bags or Paper filters, allowing for:



- Quick and easy dust disposal
- Lower-running cost compared with paper dust bag



	VC006GM (Wet & Dry)	VC003GL (Wet & Dry)	VC004GL (Dry)	DVC155L, DVC865L, DVC860L (Wet & Dry)	VC3211H, VC3211M, VC2211M, VC2201M (Wet & Dry)	VC3210L, VC2510L (Wet & Dry)	VC1310L (Wet & Dry)
Use as a set							
Powder filter set Dry only	1911B6-0 	*191V70-3 	*191V70-3 	*197166-6 	VC3211H: *196251-2 VC3211M, VC2211M VC2201M: *196252-0 	195441-4 *191F82-0 	195438-3
Damper set	1911B4-4 	191V68-0 	191V68-0 	195552-5 	196254-6 	195552-5 	195552-5
Pre-filter set	1911B5-2 	191V69-8 	191V69-8 	195553-3 	196253-8 	195612-3 	195553-3
Cloth filter Wet & Dry		144625-1 	144625-1 	140248-3 			
Water filter Wet only It is recommended using water filter when picking up large amount of water repeatedly.	1910N0-0 	191V67-2 		195555-9 DVC155L, DVC865L, DVC860L only		VC3210L: 195611-5 VC2510L: 195556-7 	195555-9
Dust paper filter 7L (5pcs) for dry powder				A-49541 			A-49541
Filter bag set 10L/15L/25L/35L (5pcs) for dry dust	35L: 1910Y4-9 	10L: 1912R3-4 VC001GL, VC002GL, VC005GL, DVC860L, DVC861, DVC865L, DVC866L, DVC867L 15L: 195557-5 VC003GL, VC004GL, DVC155L, DVC156L, DVC157L 			25L: 195558-3 	25L: 195558-3 VC3210L only 15L: 195557-5 VC2510L only 	15L: 195557-5
Poly bag set (10pcs)	1910R3-2 	195432-5 	195432-5 	195432-5 	195440-6 	195440-6 	195432-5

To use powder filter, remove the float cage and float by removing the bolts.

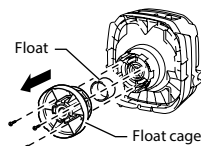

Capacity up tank set

DVC860L, DVC861L, DVC865L, DVC866L, DVC867L

* "HEPA filter" Mark on tank

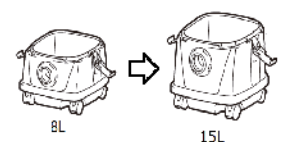

Cordless Cleaner System Charts

Color

With pipe lock Model:

- CL001G
- CL002G
- CL003G
- DCL283F
- DCL284F
- DCL286F
- CL117FD



Model:

- DCL180
- DCL181F
- DCL182
- CL183D
- CL106D
- CL107FD
- CL108FD
- CL100D



Model:

- CL070D
- CL072D



Model:

DCL184, CL121D



Cyclone attachment set with pipe lock

- 191D71-3
- 191D73-9



Flexible hose set

191E30-3



Cyclone attachment set

- 199491-1
- 191D75-5



*Included sensomatic

Flexible hose set

- 191496-7
- 198867-9
- 198541-9
- 198542-7
- 198870-0
- 198543-5



Blower nozzle complete

140J64-3



Straight pipe with pipe lock

Aluminum Telescopic pipe 28L
(L=590-942mm) 140G19-0
Bending pipe assembly with pipe lock (140G26-3) set 191B15-1

Plastic Telescopic pipe 28L
(L=590-950mm) Gray 127605-2
(L=479-719mm) ○ 1910Y3-1

Compatible model: CL001G, CL002G, CL003G, DCL283F, DCL284F, DCL286F

Plastic straight pipe 28L with pipe lock
(L=479mm)

- 459353-8
- 459356-2
- 458942-6

Plastic straight pipe 28L with pipe lock
(L=340mm)

- 191D76-3
- 191D78-9
- 191D77-1

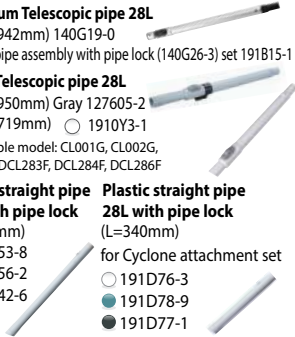

Straight pipe

Plastic Telescopic pipe 28
(L=500-850mm)

- 123584-2

Plastic straight pipe 28 (L=465mm)

- 451424-7
- 451241-5
- 451244-9
- 451425-5
- 457231-6
- 456587-4

Plastic straight pipe 28 (L=320mm) for Cyclone attachment set

- 191D79-7
- 191D81-0
- 191D80-2

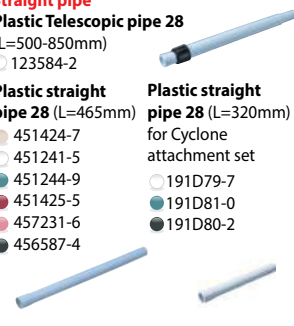

Flexible hose set



Flexible rubber nozzle 28

197900-4



28mm Tip attachments

Nozzle assembly
Floor t-nozzle 28

- 123485-4
- 123486-2
- 123488-8
- 123489-6
- 123843-4
- 123539-7



F/C switching t-nozzle 28
Flooring & carpet

- 198183-9 / 198532-0
- 199431-9



F/C switching t-nozzle 28
Flooring & carpet

191G86-8



Sash nozzle

- 416041-0
- 451240-7
- 451243-1
- 416225-0
- 457228-5
- 456586-6



Round brush

- 198552-4
- 198878-4
- 198553-2
- 198554-0
- 198881-5
- 198555-8
- Gray 191D67-4



****Rubber nozzle 330 set**

422437-5



***These nozzles cannot be attached directly to Bending pipe assembly use with telescopic pipes or straight pipes.**

Floor/carpet t-nozzle
For rug / carpet

- 198150-4 / 198149-9
- 198525-7 / 198528-1
- 198523-1 / 198527-3
- 198524-9 / 198522-3
- 198882-3 / 198883-1
- 198526-5 / 198529-9



Nozzle assembly
For rug / carpet

122291-4



Brush brush set

191M30-1



Corner nozzle 330

- 198919-6
- 198990-0
- 198992-6



Shelf brush

- 198537-0
- 198873-4
- 198538-8
- 198539-6
- 198876-8
- 198540-1



Holder set Part No. 199971-7

Model: CL001G, CL002G, DCL283F, DCL284F, DCL180, DCL180F, DCL181F, DCL182, DCL182F, CL114FD, CL107FD, CL072D



Seat nozzle 28
For automobile

- 199038-1
- 199041-2
- 199039-9



Seat nozzle 120 set
For automobile

140H95-0



Mat nozzle 120
For automobile

459056-4



Crevice nozzle 415

199439-3



Soft brush 360 complete set

140H94-2



Sash nozzle holder 28

For Plastic straight pipe

Model: CL001G, CL002G, CL003G, DCL283F, DCL284F, DCL286F, CL114FD, CL117FD

- White 459354-6
- Blue 459355-4
- Black 459038-6
- Ivory 459036-0

Others Model

- Ivory 416043-6
- White 451242-3
- Blue 451245-7
- Red 416227-6
- Pink 457229-3
- Black 456585-8



Capsule type cleaner Model: CL001G, DCL283F, DCL284F, DCL181F, DCL180F, DCL180, CL183D, CL108FD, CL106FD, CL070D

HEPA filter
199989-8
HEPA filter
Except Model: CL183D

HEPA filter + Pre filter

HEPA filter + Easy shake off dust filter

Filter + Pre filter

Pre filter
451208-3

Stay (Filter flame)
458467-0

Filter
10 per pkg
198915-4

Easy shake off dust filter

Easy shake off dust filter (High performance filter)
199966-0
455176-2

Valve
424208-6

Sponge sheet 57
422268-2
Except Model: CL070D, CL183D

Paper bag type cleaner Model: CL002G, DCL182, DCL182F, CL114FD, CL121D, CL107FD, CL072D, DCL184, CL121D

Cordless Cleaner

Sponge sheet 76-110 (Recessed wall)
424804-0

Guard
413177-0
CL002G only

Paper filter Anti-bacterial type (High performance filter)
10 per pkg.
198744-5 (EU)
5 per pkg.
198745-3

Valve stay complete (Dust stopper)
143677-9
DCL184, DCL182, DCL182F, CL114FD, CL121D, CL107FD, CL072D
140K23-3
CL002G

Dust bag
198746-1
166084-9 (w/o pkg)

Easy shake off dust bag
198748-7
Except Model: CL002G only

High performance dust bag set
1910M4-5
CL002G only

DCL184, CL121D

Sponge sheet 90
422440-6

New cyclone unit Model: CL001G, CL003G, DCL283F, DCL284F, DCL286F, DCL180, DCL181F

Compatible model:
CL001G, DCL283F, DCL284F, DCL180, DCL181F

CL003G, DCL286F (Standard Equipment)

Cyclone unit

Sponge sheet 62
422909-0 (Standard Equipment)

HEPA filter
1910C9-5
HEPA filter

High performance filter set
1910C7-9 (Standard Equipment)

Sponge filter
422908-2 (Standard Equipment)

Part No. 1910D3-4

Part No. 1910D5-0

Cleaner carrying bag

Cleaner body, battery, charger and accessories can be stored together.



Except Model: CL003G, DCL286F, DCL184, CL121D (LxWxH: 600x210x190mm)
Part No. 199901-8



Model: DCL184, CL121D (LxWxH: 490x210x230mm)
Part No. 199900-0

Blue dust capsule

Transparent blue dust capsule. You can see the accumulated dust.

Model: DCL280F, DCL281F
Part No. 136106-9



Cordless Upright Cleaner Model: DVC560

Color

28mm Tip attachments

Seat nozzle 28

For automobile
 199038-1
 199041-2
 199039-9



Long sash nozzle 330

191D65-8
 198919-6
 198990-0
 198992-6



Seat nozzle 120 set

For automobile
 140H95-0



Crevice nozzle 415

199439-3



Mat nozzle 120

For automobile
 459056-4



Round brush

191D67-4
 198552-4
 198878-4
 198553-2
 198555-8



Brush nozzle set

191M30-1



Shelf brush

198537-0
 198873-4
 198538-8
 198540-1



Sash nozzle

416041-0
 451240-7
 456586-6



Soft brush 360 complete set

140H94-2



Filter bag set

10pcs. set
 191T96-3



Main filter h set

191E39-5



Brush complete set

1910T8-6

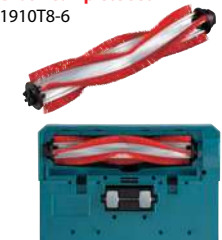

Cordless Portable Vacuum Cleaner Model: DVC750L

For Cleaning Hose Complete

28-2.0m with
 Front cuffs 38
 140G04-3



38mm Tip attachments

Wide Nozzle

458891-7



Sash Nozzle

458919-1



Round brush

191657-9



Corner nozzle

410306-2



Joint 22-38

195548-6



Tapered nozzle set

192236-6



Joint 38

418500-0



28mm Tip attachments

Dry only



Filter complete (HEPA filter)

Dry

162518-0



Pre filter and Damper set

Dry only

199827-4

Damper

422449-8



Pre filter

162635-6



Wet only



Wet filter set

191M39-3



Shoulder Belt Set

199486-4



Backpack Vacuum Cleaner Model: VC008G, VC009G, DVC660, DVC665, DVC261, DVC265

DVC660, DVC665

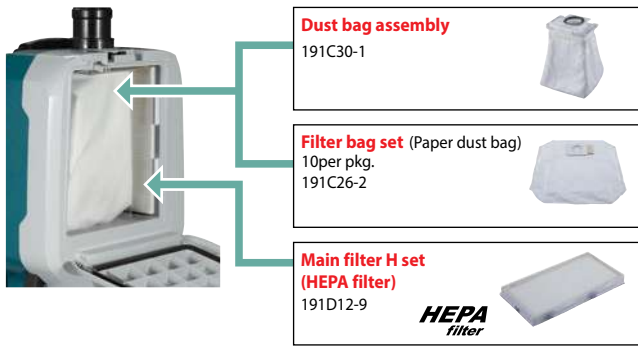

VC008G, VC009G, DVC261, DVC265

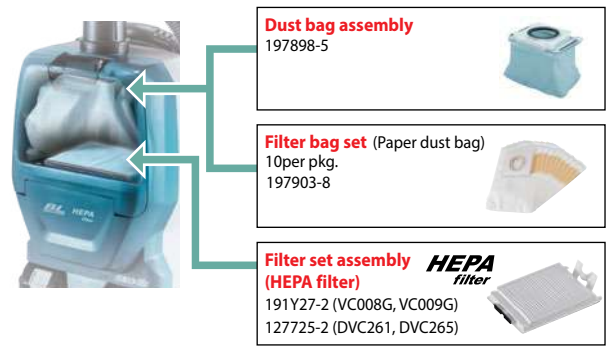

Robotic Cleaner Model: DRC200, DRC300

DRC200

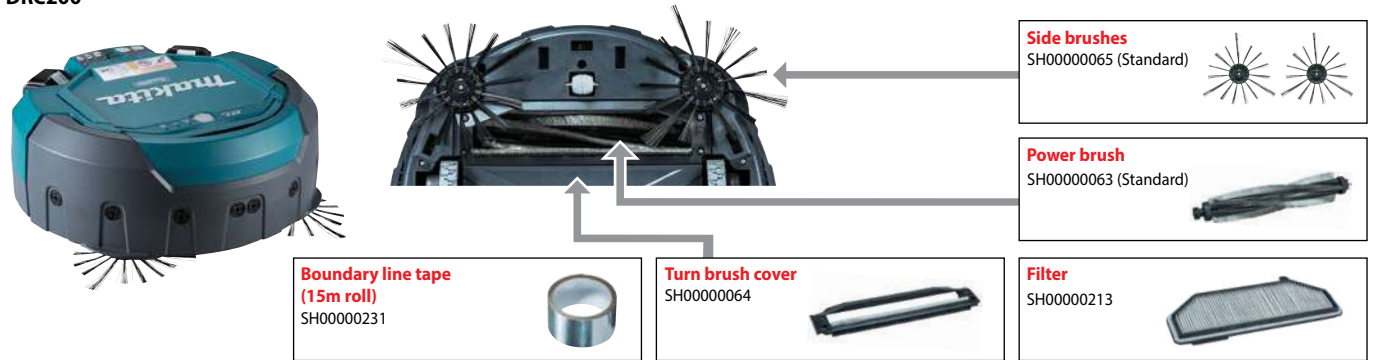

DRC300

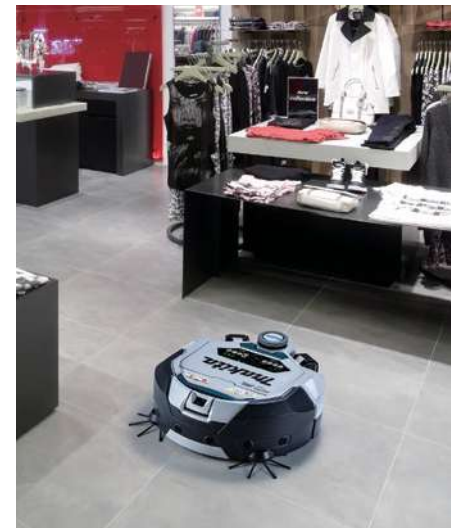
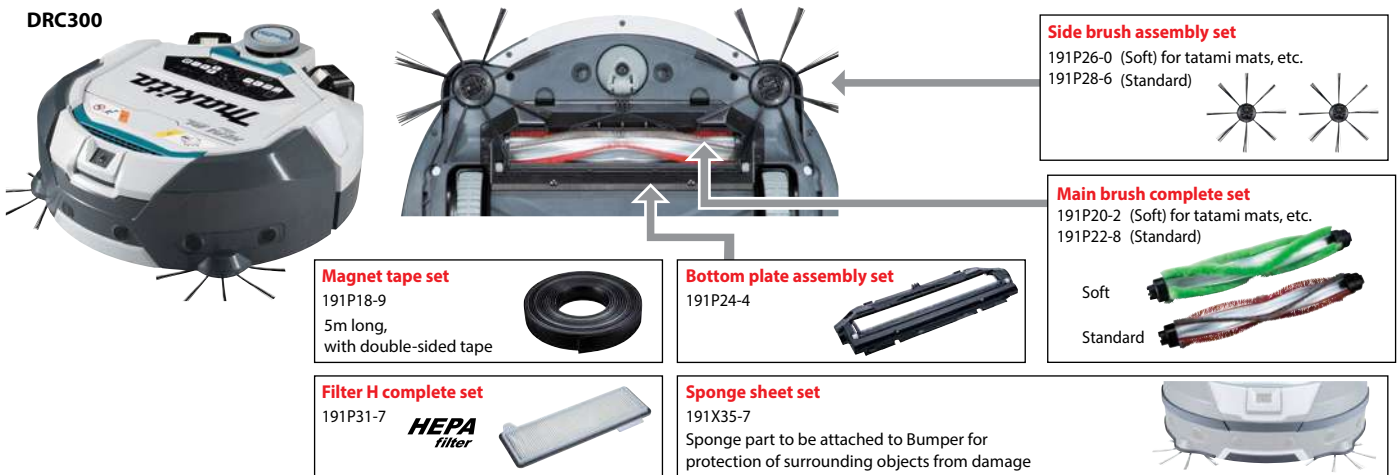

Dust Extraction

28mm Hose



Length (m)	Hose type	Front cuffs	Included Items	Part No.
1.0	Antistatic hose	without cuffs	---	143787-2
1.5	Antistatic hose	without cuffs	---	144408-9
1.5	Antistatic hose	Front cuffs 38	---	152992-0
1.5	Antistatic hose	Front cuffs 38	Front cuffs 22	A-34235
2.5	Antistatic hose	Front cuffs 22	Front cuffs 38 Front cuffs 24	195437-5
3.5	Antistatic hose	Front cuffs 38	Front cuffs 22 Front cuffs 24	195433-3

Front Cuffs for 28mm hose or joint

Type	Hose Side	Cuff Type	Part No.
Front cuffs 22	28mm hose w/o cuffs	cuffs 22	195547-8
Front cuffs 38	28mm hose w/o cuffs	cuffs 38	195545-2
Front cuffs 24	Cuffs 22 or Cuffs 38	cuffs 24	195546-0
Joint 25 set	Cuffs 24	cuffs 22	192349-3
Rubber sleeve 18-21	Cuffs 22	For 18-21mm pipe	192202-3

Hose band



Hose Size	Part No.
28/32/38	166116-2

28mm Bending pipe



Matching hose set / Matching cuffs	Matching pipe	Part No.
28mm hose w/o cuffs	28L	127093-3
	28	126756-8

28mm Bending pipe & Aluminum Telescopic pipe set



Matching cuffs	Matching nozzle	Part No.
Front cuffs 32A	28	191B15-1

Straight pipe 28L & 28

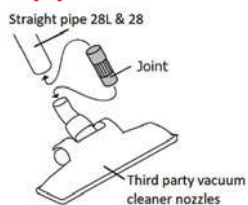

Joint type	Part No.	Third party vacuum cleaner nozzles
C38	191M79-1	Proteam Side Winder
B35	191M78-3	KARCHER Nilfisk
A32	191M77-5	PACVAC SHOPVAC Proteam

Aluminum pipe 32

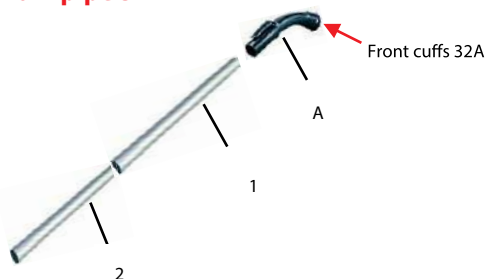

Item	Description	Material	Part No.
1	Aluminum joint pipe 32 (L=465mm)	Aluminum	199844-4
2	Aluminum straight pipe 32 (L=465mm)	Aluminum	199843-6

Hose 38mm



Length (m)	Hose type	Front cuffs	Part No.
1.5	Antistatic hose	Front cuffs 38	198757-6
2.5	Antistatic hose	Front cuffs 38	195434-1
5	Antistatic hose	Front cuffs 38	195435-9

Joint 38mm hose

Type	Hose Side	Nozzle side	Part No.
Front cuffs 24	Cuffs 22 or Cuffs 38	Cuffs 24	195546-0
Joint 22-38	Cuffs 38	Cuffs 22	195548-6
Joint 38	Cuffs 38	Nozzle 28	418500-0
Joint 25 set	Cuffs 38	70mm pipe with O-ring	181575-9

Nozzle assembly for vacuum & blow



Model	Size (mm)	Part No.
DUB182, DVC350	220	132025-7
UB100D, UB101D, DUB185, DUB186 UB1102, UB1103	220	123245-4
	430	123246-2

Dust box assembly



Model	Part No.
LS0714, LS0714F, LS0714FL, LS0814FL, LS1216, LS1216FL, LS1216L	194175-6

Dust Extraction

Cleaning set

Includes one each of:
 -Hose complete 38-2.5
 -Straight pipe
 -Bending pipe
 -Nozzle assembly
 -Corner nozzle



Part No.
195439-1

Aluminum pipe 38



Item	Description	Material	Part No.
1	Bending pipe	Aluminum	192562-3
2	Straight pipe	Aluminum	192563-1
3	Stopper + Screw M4 x 20	---	451350-0 413R35-4

Aluminum Telescopic pipe 38



Length (mm)	Part No.
606-958	1912G4-5

32mm Hose B type



Model No.	Size	Length (m)	Part No.
VC2012L, VC2512L, VC3011L	32B	3.5	P-81739

Tool adaptor



Model No.	Description	Part No.
VC3012L/M, VC4210L/M VC2012L, VC2512L, VC3011L	Joint 25-50	192349-3

Filter & bag

Model No.	Description	Per pkg.	Part No.
VC2000L	Fleece filter bag (Filter bag)	5	P-72899
	Pre Disposal bag	5	P-70297
	PET Filtecent	1	P-70219

Dust bag



Model	Part No.
DUB182, UB1100, UB1101	122321-1
DUB185, DUB186, UB100D, UB101D, UB1102, UB1103	123241-2

Tapered nozzle set for blower



Nozzle assembly (P/N:132025-7) is also necessary

Model	Color	Part No.
DVC350, UB100D, UB101D, DUB182, DUB185, DUB186	Gray	192236-6

Bending long nozzle set / Garden Nozzle Assembly Set for blow



Model	Part No.
UB1102, UB1103	196729-5
DUB182, DUB183	TP00000199
UB100D, UB101D, DUB185, DUB186, UB1102, UB1103	191G09-6

Flexible hose, straight pipe, set

(Total length: 95cm)



Model	Part No.
DUB182, UB1100, UB1101	191750-9
DUB185, DUB186, UB100D, UB101D, UB1102, UB1103	196643-5

Flexible hose set



Model	Part No.
DUB185, DUB186, UB100D, UB101D, UB1102, UB1103	191M34-3

Wiper nozzle set (for blowing away)



Model	Part No.
DUB185, DUB186, UB100D, UB101D, UB1102, UB1103	191M32-7

Brush nozzle set



Model	Part No.
DUB185, DUB186, UB100D, UB101D, UB1102, UB1103	191M30-1

For DCL501









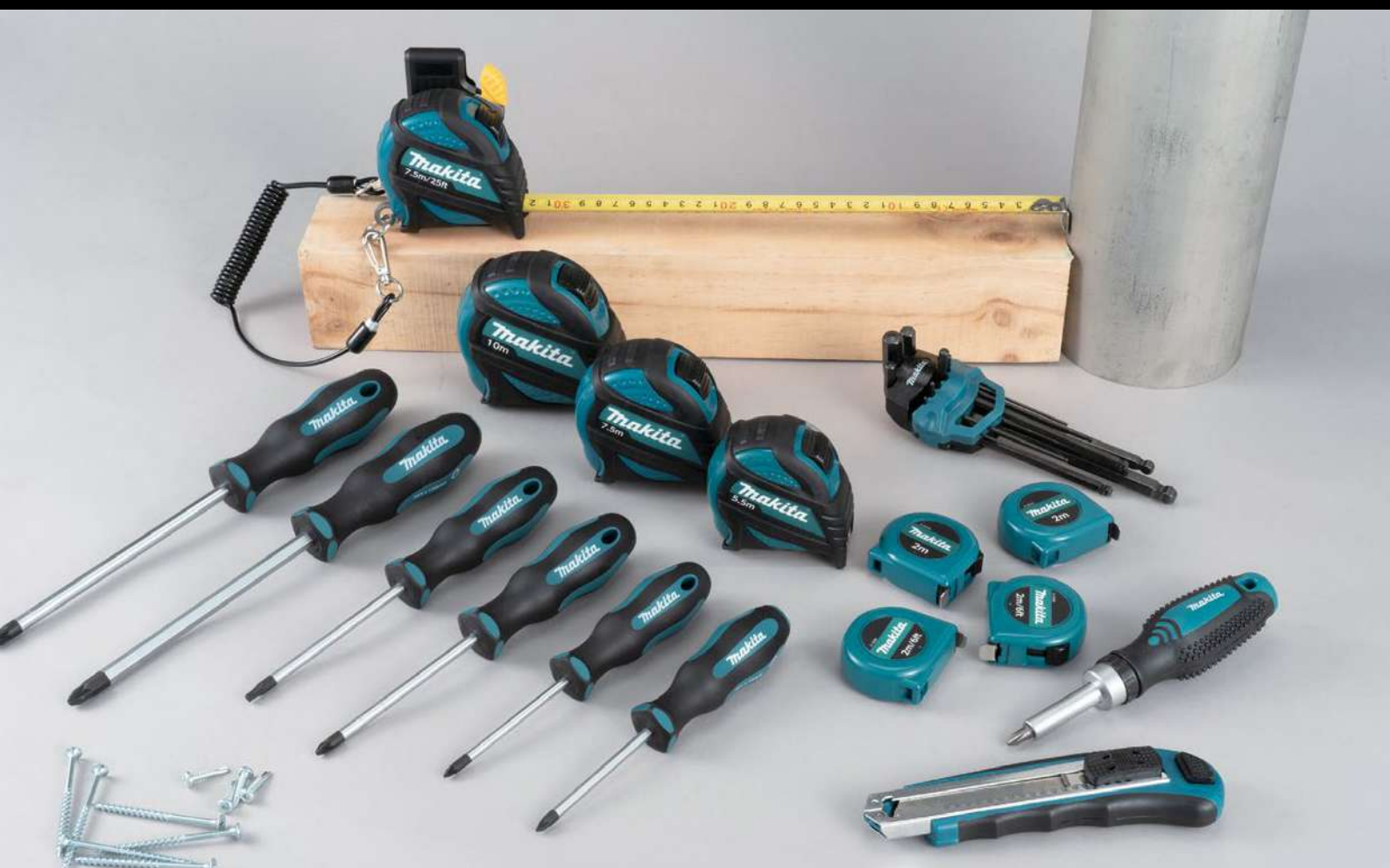

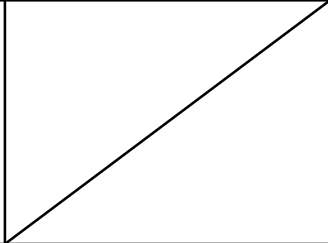

Model	Type	Part No.
Hose	-	SH00000034
Straight pipe	Adjustable length	SH00000060
Nozzle assembly	Flooring & carpet	SH00000058
Crevice nozzle	-	SH00000042

ACCESSORIES

▣ Miscellaneous



Miscellaneous

<p>Adjustable wrench</p> 		<p>Wide excursion jaw allows each tool to work with even more fastener sizes.</p>	
<p>Spanner</p>	<p>Open end</p> 		<p>U-shaped opening grips with two opposite face of the bolts and nuts. Due to the opening, it can easily access to bolts and nut.</p>
<p>Spanner</p>	<p>Flare end</p> 		<p>Narrow opening which is wide enough to fit over the tube. Large contact surface with fastener reduces rounding. Suitable for aluminum, copper and brass hexagonal fittings on oil pipe.</p>
<p>Spanner</p>	<p>Box end</p> 		<p>Enclosed opening grips snugly fits the faces of the bolts and nuts. Force can be applied to bolts or nuts with decreased chance of damaging.</p>
<p>Ratcheting wrench</p> 		<p>The ratcheting mechanism allows fastener to be tightened or loosened without disconnecting the tool from it. It makes the works more rapidly.</p>	
<p>Hex key wrench with ball-end</p> 		<p>Used for tightening or loosening cap screw and bolts with hexagonal sockets attached to their heads. A ball end allows the tool to be used at an angle off-axis to screw and bolt. It means it can used at tightening area.</p>	



Miscellaneous

Tape measure



Makita tape measure is highly durable and convenient. When the scales are blurred or hook is lost, that would be the end of its life. This measure is for professional which has a special coated tape, hook protector and damper which absorbs shocks leads to great durability.



Feature

1. Special Coating

- * "DURA COAT" makes 5 times more durable
- * "SILICA COAT" makes easier note



2. High durability of Hook

- * Installed damper absorbs the shock on the hook
- * Hook protector reduces the shock on the hook
- * Tightly fixed hook with "4rivets+protector"



3. Convenience

- * 2-sided print
- * Hook with magnet
- * "Matte finish" makes easier to read scales
- * Standout



Printed size



Size	Length	Width	Part No.
cm/inch	2m/6ft	13mm / 1/2"	E-10590

Size	Length	Width	Part No.
cm/inch	5.5m/18ft	25mm/1"	*B-57211

Size	Length	Width	Part No.
cm	3.5m	16mm	B-57130

Tape measure with holder & safety cord

Size	Length	Width	Part No.
cm/inch	7.5m/25ft	25mm/1"	B-68351

Miscellaneous

Screw driver



	Size	Length (mm)	Part No.
+	PH2	100	B-65919
	PH3	150	B-65931
+	PZ1	80	B-65947
	PZ2	100	B-65953
	PZ3	150	B-65969
*	T10	100	B-65975
	T15	100	B-65981
	T20	100	B-65997
	T25	100	B-66008
	T30	100	B-66014
-	SL4.0	100	B-66020
	SL5.5	100	B-66036
	SL6.5	125	B-66042
	SL8	150	B-66058



Go thru Screw driver



	Size	Length (mm)	Part No.
+	PH1	75	B-66064
	PH3	150	B-66086
+	PZ1	75	B-66092
	PZ2	100	B-66101
	PZ3	150	B-66117
-	SL5.5	75	E-04933
	SL6.5	150	E-04949
	SL8	200	E-04955



Miscellaneous

40 pcs. Ratcheting Tap & die set



Part No.
B-65838

Ratchet & socket set



Drive	Contents	Sum	Part No.
3/8" SQ	84T Ratchet, Adapter to 1/2" SQ, Socket: 8, 9, 10, 11, 12, 13, 14, 15, 16, 17, 18, 19, 20mm, Middle socket: 8, 10, 13, 16, 17, 19mm, Extension bar: 3", 6"	23	B-65573

Pass thru socket set



Contents	Sum	Part No.
Pass thru Socket : 10, 11, 12, 13, 14, 15, 16, 17, 18, 19mm, Socket adapter: 1/4", 3/8", Pass thru Extension bar: 75mm, Ratchet handle (Pass thru handle straight)	14	B-65595
Pass thru Socket: 10, 11, 12, 13, 14, 15, 16, 17, 18, 19mm, Pass thru Socket: 3/8", 7/16", 1/2", 9/16", 5/8", 11/16", 3/4", Socket adapter: 1/4", 3/8", Pass thru Extension bar: 75mm, Ratchet handle (Pass thru handle straight)	21	B-65604

Pass thru extension bar



Part No.
B-65632

Socket adapter



Sum	Part No.
1/4"	B-65844
3/8"	B-65850

Locking flex pass thru handle



Part No.
B-65626

Pass thru handle straight



Part No.
B-65610

Pass thru socket



Size	Part No.	Size	Part No.
10mm	B-65648	15mm	B-65698
11mm	B-65654	16mm	B-65707
12mm	B-65660	17mm	B-65713
13mm	B-65676	18mm	B-65729
14mm	B-65682	19mm	B-65735

Spare blade 10 pcs. set



Part No.
B-65517

Retractable utility knife



Part No.
B-65785

Quick change Folding utility knife



Part No.
B-65501

Miscellaneous

Combination wrench 9pcs. set



Size	Part No.
8, 10, 12, 13, 14, 15, 16, 17, 18mm	B-65539

Double box wrench 5pcs. set



Size	Part No.
8x9, 10x11, 12x13, 14x15, 18x19mm	B-65551

Flare nut wrench 5pcs. set



Size	Part No.
9x11, 10x12, 13x14, 15x17, 16x18mm	B-65545

Double ratchet wrench 8pcs. set



Size	Part No.
8, 10, 12, 13, 14, 15, 17, 19mm	B-65523

Box joint water pump pliers



Overall length	MAX Jaw Size	Part No.
7"(180mm)	37mm	B-65741
9.5"(240mm)	49mm	B-65757
12"(300mm)	68mm	B-65763

Water pump pliers



Overall length	MAX Jaw Size	Part No.
10"(250mm)	51mm	B-65486
12"(300mm)	76mm	B-65492

Smooth Face Claw Hammer



Overall length	Size	Part No.
250mm	20 OZ. (0.57kg)	B-65779

Aviation snip



Description	Cutting Capacity		Part No.
	Cold-Rolled Steel	Stainless Steel	
Cuts straight	18ga (1.22mm)	23ga (0.61mm)	B-65791
Cuts left			B-65800
Cuts right			B-65816
Bull dog			B-65822

Adjustable wrench



Length	Capacity	Part No.
6"(150mm)	29mm	B-65414
8"(200mm)	36mm	B-65420
10"(250mm)	38mm	B-65436
12"(300mm)	43mm	B-65442

11 pcs. Pass thru adjustable wrench set



Description	Size	Part No.
Adjustable wrench	200mm	B-65458
3/8" socket	3/8"(10mm), 7/16"(11mm), 15/32"(12mm), 1/2"(13mm), 9/16"(14mm), 19/32"(15mm), 5/8"(16mm), 11/16"(17mm), 23/32"(18mm), 3/4"(19mm)	

Locking adjustable wrench



Overall length	MAX Jaw Size	Part No.
10"(250mm)	35mm	B-65470

Miscellaneous

MAKPAC Stacking Cases



Description	Part No.
Makpac case 4 drawer (L : 395mm X W : 295mm X H : 210mm)	P-84311



Description	Part No.
Makpac case 5 drawer (L : 395mm X W : 295mm X H : 320mm)	P-84349



Description	Part No.
Makpac case 12 drawer (L : 395mm X W : 295mm X H : 210mm)	P-84327



Description	Part No.
Makpac stackable cantilever tool box (L : 395mm X W : 295mm X H : 234mm)	P-84137



Description	Part No.
Makpac organiser set (L : 395mm X W : 295mm X H : 105mm)	191X80-2

Joint Plastic Case



Type	Size(mm)	Part No.
Small	105 x 395 x 295	821549-5
Medium	158 x 395 x 295	821550-0
Large	210 x 395 x 295	821551-8
Extra Large	316 x 395 x 295	821552-6



Trolley



Image is for reference only

Part No.
TR0000002

Tray



Part No.
P-83652



Part No.
P-83674

Miscellaneous

Pin nail



Model No.	Type	Length	Part No.
AF201Z, AF353, DPT351, DPT353, PT354D, AF353, DPT351, DPT353, PT354D	23Ga(φ0.6) Pin Nail (3,000 pcs/box)	18mm (11/16")	F-00013
		25mm (1")	F-00026
		30mm (1-3/16")	F-01819
		35mm (1-3/8")	F-00055

Brad Nail



Model No.	Type	Length	Part No.
AF506, DBN350, DBN500	18Ga Brad Nail (5,000 pcs/box)	15mm (5/8")	B-04307
		20mm (3/4")	B-04313
		25mm (1")	B-04329
		30mm (1-3/16")	B-04335
		35mm (1-3/8")	B-04357
		50mm (2")	B-04391

Staple



Model No.	Type	Length	Part No.
DST421	4mm Crown Staple 16 ga (5,000 pcs/box)	10mm	B-04400
		13mm	B-04416
		19mm	B-04438
		22mm	B-04444
		25mm	B-04450
DST121	10mm Crown Staple 16 ga (5,000 pcs/box)	10mm	B-04466
		13mm	B-04472
		19mm	B-04494
		22mm	B-04503

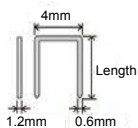

Hex wrench





Model No.	Size	Part No.
JN1601, 2012NB	2.5mm	783208-8
JN3200, JS1600, JS1660, JS1670, 4331D, 4333D, 4334D, 4300BA, 4300BV, 4326/M, 4327/M, 4328, 4329, JV0600	3mm	783201-2
JS3200, 4350T/CT/FCT, 4351T/CT/FCT, BJV140, BJV180, 1806B, N1923B, 1911B	4mm	783202-0

Side Grip / Front cover

Model No.	Item	Part No.
UT1305, UT2204		152892-4





Shaft Holder

Model No.	Item	Description	Part No.
DUT130 DUT131		1+2 Chuck 13mm + Chuck key set Capacity: 1.5-13mm Thread size: 1/2-20 UNF	196008-1
		1 Chuck 13mm Capacity: 1.5-13mm Thread size: 1/2-20 UNF	766016-2
		2 Chuck key S13	763448-4
UT1305		Shaft holder 1/2-M12	323962-8
UT2204		Shaft holder 5/8-M12	324265-3

Miscellaneous

Mixing blade



Application	Mixing Blade			Bolt		Shaft			Model
	Size	Material	Part No.	Bolt Size	Part No.	Bolt Size of Power Mixer	Size	Part No.	
	130mm	INOX	A-43670	M8 x 18	265220-5	M12	L=584mm D=12mm	321086-4	UT1301
	135mm	Aluminum	A-43723	W5/16 x 16	265475-2	M12	L=584mm D=12mm	-	DUT130 UT1305 UT2204
	150mm	INOX	*A-43686	---	---	M12	L=584mm D=12mm	168349-5	DUT130 UT1305 UT2204
	165mm	INOX	A-43692	M8 x 18	265220-5	M12	L=584mm D=12mm	168349-5	DUT130 UT1305
	175mm	Aluminum	A-43701	W5/16 x 16	265475-2	M12	L=584mm D=12mm	-	UT1305 UT2204
	183mm	Aluminum	A-43739	W5/16 x 16	265475-2	M12	L=584mm D=12mm	-	UT1305 UT2204
	190mm	Steel	A-33065	W5/16 x 16	265475-2	M12	L=584mm D=12mm	-	UT2204
	201mm	Steel	A-33071	W5/16 x 16	265475-2	M12	L=584mm D=12mm	-	UT2204
	220mm	Aluminum	A-43717	M8 x 16	265440-1	M12	L=584mm D=12mm	-	UT2204
	175mm	Aluminum	312D12-8	M8 x 16	265440-1	M12	L=584mm D=12mm	-	UT001G

Accessories for Tools

*Compatible with our DC tools only
 **Compatible with both our DC and AC tools

192

Cordless tools*

Straight Head

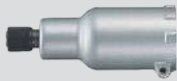

Threaded Rod Cutter Blade



Cutter Blade Set



Holder Set



Battery Protector

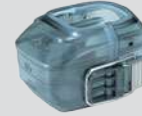

Tie Wire Set



200

Drilling / Fastening**

Drill Chuck



Angle Attachment



Shear Wrench Sleeve



Locator



Autofeed Attachment Set



202

Impact Drilling / Demolition**

Dust Cup



Hammer Carrier



Dust Extraction System Set



Grease Vessel



Dustcup Set



206

Cutting (New Material / Masonry)**

Rip fence



Base set



Hook



Side Grip



206

Cutting (Metal)**

Portable Band Saw Stand



Cover set

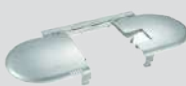

Cutting wax



Shear blade

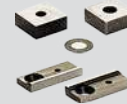

208

Grinding / Sanding**

Wheel Guard



Rubber Pad



Lock Nut Wrench



Collet Cone & Nut



Punch Plate



219

Sawing**

Rip Fence Assembly



Guide Rule



Stand



Guide Rail

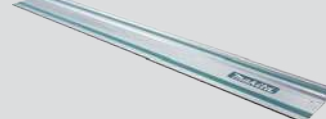

Guide Rail Adaptor

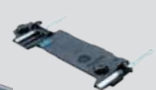

223

Planing / Routing**

Circular Guide Set



Collet Corn / Collet Nut



Templet Guide



Trimmer Base



Straight Guide Assembly



225

Others**

Heat Gun Accessories



Multi Line Laser Accessories



Carbon brush



Cordless Tools

Straight head, Angle head, Angle wrench head, Ratchet head

Straight head



Angle head



Angle wrench head



Ratchet
For Model:

DTL060, DTL061, DTL062, DTL063, TL064D, TL065D

Description	Type	Part No.
Straight head	NZ	192440-7
Angle head	-	135183-8
Ratchet head	Hex. Size 21mm	192439-2

Ratchet head adapter (Socket, Socket adapter)

Use with Ratchet head
Socket



Model No.	Type	Size	Part No.
DTL060, DTL061, DTL062, DTL063, TL064D, TL065D	Hex Socket	17 x 31 (A x L)	134743-3
		19 x 33 (A x L)	134744-1

Socket adapter

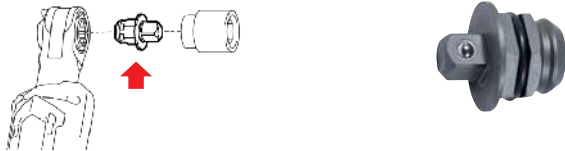

Model No.	Type	Size	Part No.
DTL060, DTL061, DTL062, DTL063, TL064D, TL065D	Socket adapter	9.5mm (3/8")	134745-9
		12.7mm (1/2")	134746-7
DWR180, WR100D	Socket adapter	6.35mm (1/4")	191A51-1
		9.5mm (3/8")	191A50-3

Threaded Rod Cutter Blade set (2pcs set)



For Model:
DSC102 SC103D

Thread type	Thread size	Part No.
ISO Metric	M6	199086-0
	M8	199084-4
	M10	199083-6
ISO Inch / BSW (British Standard Whitworth)	3/8"-16 UNC / W3/8	199080-2

Shoulder strap



Model No.	Part No.
DSC102 SC103D	199069-0

Cutter Blade set (2pcs set) for steel rod cutter

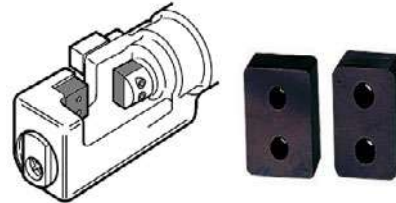

Model No.	Part No.
DSC162, DSC162R, DSC163	SC09002470
DSC191, DSC191R	SC09002030

Holder set

A: 300ml size Holder



B: 600ml size Holder



C: 800ml size Holder



D: 400mL size Holder



Model No.	Type	Size	Part No.
CG100D, DCG140, DCG180	A	300ml	196351-8
	B	600ml	1911T4-0
	C	800ml	197195-9

Cordless Tools

For DPP200

Combination of punch and die

- Punching holes through a thin structural metal plate may cause deformation of the plate and burr on the holes.
- If you need precision punching, see the tables below to select an optimum combination of punch and die.

● Round punching ○ Oblong punching



● Round punching						
Punch		Die		Cutting material		
				Tensile Mild Steel (65,000 psi)	Channel	Tensile Stainless Steel (89,000 psi)
Hole diameter (mm)	Part No.	Hole diameter (mm)	Part No.	Thickness		
6	SC05340040	SB6	SC00000203	t2-t4		t3-t4
6.5	SC05340050	SB6.5	SC00000205	t2-t6		t3-t4
8	SC05340060	SB8	SC00000207	t2-t6		t3-t4
8.5	SC05340070	SB8.5	SC00000209	t2-t6		t3-t4
10	SC05340080	SB10	SC00000211	t2-t6	t7.5	t3-t4
11	SC05340090	SB11	SC00000213	t2-t8	t7.5	t3-t6
12	SC05340100	SB12	SC00000215	t2-t8	t7.5	t3-t6
13	SC05340110	SB13	SC00000217	t2-t8	t7.5	t3-t6
14	SC05340120	SB14	SC00000219	t2-t8	t7.5	t3-t6
15	SC05340130	SB15	SC00000221	t2-t8	t7.5	t3-t6
16	SC05340140	SB16	SC05332710	t2-t8	t7.5	t3-t6
18	SC05340150	SB18	SC00000223	t2-t8	t7.5	t3-t6
19	SC05340170	SB19	SC05332740	t2-t8	t7.5	t3-t6
20	SC05340160	SB20	SC05352510	t2-t8	t7.5	t3-t6

○ Oblong punching						
Punch		Die		Cutting material		
				Tensile Mild Steel (65,000 psi)	Channel	Tensile Stainless Steel (89,000 psi)
Hole diameter (mm)	Part No.	Hole diameter (mm)	Part No.	Thickness		
6.5 x 10	SC05340200	6.5 x 10B	SC00000244	t2-t6		t3-t4
6.5 x 13	SC05340210	6.5 x 13B	SC00000246	t2-t6		t3-t4
8.5 x 13	SC05340220	8.5 x 13B	SC00000248	t2-t6		t3-t4
8.5 x 17	SC05340230	8.5 x 17B	SC00000250	t2-t6		t3-t4
9 x 13.5	SC05340240	9 x 13.5B	SC00000252	t2-t6		t3-t4
9 x 18	SC05340250	9 x 18B	SC00000254	t2-t6		t3-t4
10 x 15	SC05340260	10 x 15B	SC00000256	t2-t8	t7.5	t3-t6
10 x 20	SC05340270	10 x 20B	SC00000258	t2-t8	t7.5	t3-t6
11 x 16.5	SC05340280	11 x 16.5B	SC00000260	t2-t8	t7.5	t3-t6
12 x 18	SC05340290	12 x 18B	SC00000262	t2-t8	t7.5	t3-t6
13 x 19.5	SC05340300	13 x 19.5B	SC00000264	t2-t8	t7.5	t3-t6
14 x 21	SC05340310	14 x 21B	SC00000266	t2-t8	t7.5	t3-t6

Work stand

Part No. SC03801080

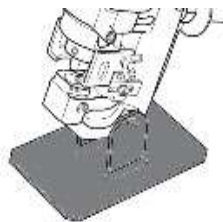

Slide stopper

Part No. SC03300790

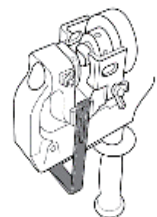

Hydraulic pressure oil for steel rod cutter / puncher

DPP200, DSC121, DSC162, DSC162R, DSC163, DSC192

Part No. SC00000106
35mL



Part No. SC00000142
150mL



Cordless Tools

Cordless Inflator Adapter

For Model:
DMP180, MP100D

Item	Part No.
French valve adapter	TE00000334
Swim ring adapter	TE00000333
Ball adapter	TE00000335

Polishing and Buffing items for Drill

Rubber pad assembly



Collet size	Pad Size	max. rpm	Part No.
6mm	98mm	3,000	123001-2

Wool bonnet



Size	Part No.
100mm	794173-6

Foam polishing pad



Pad Size	Part No.
125mm	794159-0

Quick charger

(AC only)



Model No.	Charging time (min.) (approx.)	Charger type
CL104D, CL105D, CL111D	180	196832-2

Tie wire set

Ø0.8mm
50 pcs/ box



Model No.	TYPE	Wire length / bobbin	Part No.
DTR180	Standard	Approx 100m	199137-9
	Galvanized	Approx 100m	191A57-9
	Poly Coated	Approx 100m	191J59-9

Wire Guide B



Model No.	Part No.
DTR181	162945-1
	1911H9-6

For DRC200

Side brushes



Power brush



Boundary Line Tape



Turn brush cover



Filter



Description	Part No.
Side Brushes	SH00000065
Power Brush	SH00000063
Turn Brush Cover	SH00000064
Filter	SH00000213
Boundary Line Tape	SH00000231

For DRC300

Side brushes



Magnet Tape Set



Filter



Main Brush Complete



Sponge Sheet Set



Bottom Plate Assembly



Description	Part No.
Side brushes	191P28-6
Side brushes	191P26-0
Filter	191P31-7
Sponge Sheet Set	191X35-7
Magnet Tape Set	191P18-9
Main Brush Complete	191P22-8
Main Brush Complete	191P20-2
Bottom Plate Assembly	191P24-4





Extension handle kit

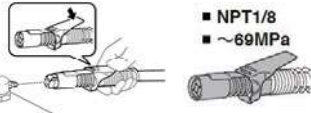

Model No.	Part No.
DTR180	191M27-0
DTR181	191M27-1

Cordless Tools

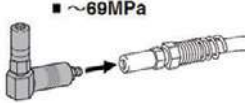
Nozzle for DGP180

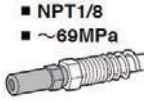
Item	Part No.
 	191A76-5
 	191A77-3
 	191A78-1

Hose for DGP180



Item	Length	Part No.
Flexible hose 600	0.6m	191A80-4
Flexible hose 1200	1.2m	191A79-9

Barrel for DGP180

Item	Size	Part No.
	For 400g grease cartridge	191B12-7
	For 450g grease cartridge	122D17-8
	For 500g grease cartridge	191F23B6

Shoulder strap for DGP180



Item	Part No.
Shoulder Belt	166094-6

Blade for steel rod cutter



Model No.	Part No.
DSC251	E-11097

Cordless rivet gun

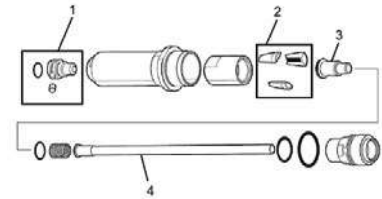

For DRV150

Items	1	2		3		4	
	Nose piece assy	Jaw (3pcs set)		Jaw pusher assy		Pipe	
Rivet Size	Part No.	Marking on jaw	Part No.	Color Size	Part No.	Color Size	Part No.
ø2.4 mm (3/32")	127230-9	4.8	199731-7	Gray 1.9	127478-3	Silver 2.2	162747-5
ø3.2 mm (1/8")	127229-4			Black 2.5	127477-5	Black 2.6	162746-7
ø4.0 mm (5/32")	127228-6			Gray 3.1	127476-7	Pipe is not necessary for operation.	
ø4.8 mm (3/16")	127225-2			Black 3.6	127475-9		

Accessory set

Size	Part No.	Size	Part No.
for 2.4	199729-4	B set for 4.0	191C04-2
for 3.2	199728-6	B set for 4.8	191C03-4

For DRV250

Items	1	2		3		4	
	Nose piece assy	Jaw (3pcs set)		Jaw pusher assy		Pipe	
Rivet Size	Part No.	Marking on jaw	Part No.	Color Size	Part No.	Color Size	Part No.
ø2.4 mm (3/32")	127230-9	4.8	199731-7	Gray 1.9	127478-3	Silver 2.2	162747-5
ø3.2 mm (1/8")	127229-4			Black 2.5	127477-5	Black 2.6	162746-7
ø4.0 mm (5/32")	127228-6			Gray 3.1	127476-7	Silver 3.4	162745-9
ø4.8 mm (3/16")	127225-2			4.8 / 6.4	199731-7 / 199730-9	Black 3.6	127475-9
ø6.0 mm (7/32")	127224-4	6.4	199730-9	Gray 4.0	127474-1		
ø6.4 mm (1/4")	127223-6	6.4		Black 4.5	127473-3	Silver 4.5	162743-3

Accessory set

Size	Part No.	Size	Part No.
for 2.4	199729-4	B set for 4.8	191C03-4
for 3.2	199728-6	for 6.0	199725-2
A set for 4.0	191F80-4	for 6.4	191C02-6
A set for 4.8	191F79-9		

Jaw grease for maintenance (Grease to jaw case & jaws)



Description	Size	Part No.
Molybdenum disulfide grease	5g	191D57-7

Cordless Tools

Bulb

(2 pcs. / set)



Model No.	Voltage	Part No.
DML184	14.4V,18V	B-07303

Light stand (Tripod)



GM00001381



GM00002073

Model No.	Height	Description	Set Screw	Part No.
DML805	992-1,750mm	Up to two DML805's can be mounted.	M8	GM00001381
DML809 DML811	1,300-2,000mm	Up to two lights can be mounted.	M10 bolt & nut	GM00002073

Magnetic Adapter Attachment



Model No.	Part No.
ML104, ML105, ML106	GM00001714

Strap



Model No.	Part No.
DML812	GM00002239

Battery protector

For Battery BL1430B, BL1440, BL1450, BL1460B, BL1830B, BL1840B, BL1850B, BL1860B



Model No.	Part No.
DDA340, DDA350, DDA351, DDF343, DDF451, DDF453, DHP343, DHP451, DHP453, DHR202, DTD134, DTD137, DTD146, DTD148, DTD152, DTD153, DTD154, DTD155, DTD170, DTD171, DTL060, DTL061, DTL062, DTL063, DTS130, DTS131, DTS141, DTW250, DTW251, DTW253, DTW450	194649-7

Battery protector

Designed to protect the battery cartridge from dust and dripping water in outdoor applications or harsh environments.



Model No.	For Battery	Part No.
DDF458, DHP458, DTD146	BL1815N, BL1820, BL1830B, BL1840B, BL1850B, BL1860B	195798-3

Tool catcher set (with shoulder belt)



Model No.	Part No.
DTD134, DTD137, DTD138, DTD148, DTD149, DTD152, DTD170, DTS130, DTS131, DTS141, DTW152, DTW190, DTW250, DTW251, DTW253, DTW284, DTW285, DTW300, DTW301	197941-0

Tool catcher set

Enables to hook the machine quickly on a snap hook of waist belt.



Model No.	Part No.
DTD157, DTW300, DTW301, TW004G, TW005G	191K57-9
DTD134, DTD137, DTD146, DTD148, DTD153, DTD154, DTD155, DTD170, DTS130, DTS131, DTS141, DTW152	197043-2
TD001G	191F58-7

Cordless Tools

Battery adapter & Battery converter

PDC01



BAP182



BCV01



BAP18C



Type	Battery type	For Model
PDC01 191A62-6 191A67-6	LXT 18V Battery x4	LXT 18V Models LXT 18Vx2 Models or Direct connection 36V Models
BAP182 197581-4	LXT 18V Battery x2	LXT 18Vx2 Model
BCV01 195511-9	LXT 18V Battery x2	Old 36V Models
BAP18C 191M50-5	LXT 18V Battery	LXT 18V

Battery adapter for PDC01 & LXT 18V Battery models

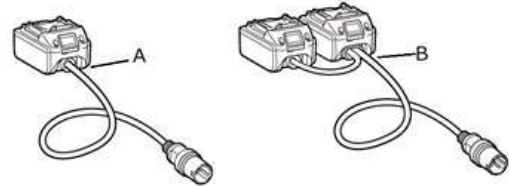

Item	Part No.
A	191A53-7
B	191J51-5

Harness for BAP182/ BCV01

Harness

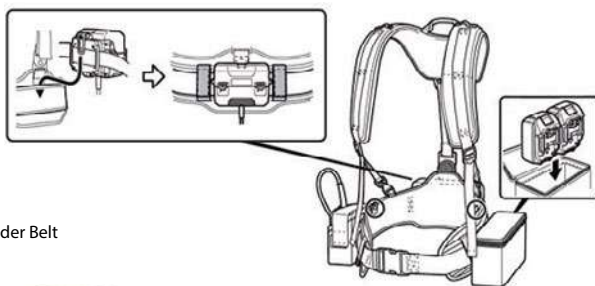

Shoulder Belt



Type	Part No.
Shoulder Belt	162523-7

Battery adapter for PDC01/ PDC1200 & XGT 40VMax Battery models



Item	Part No.
C	191N62-4

Cordless Tools

Coffee Maker accessories

For model:
DCM501



Item	Part No.
Cup cover 	KF0000021
Cup 	KF0000020
Filter 	KF0000013
Spoon 	KF0000033

Anti kick back head assembly



Model No.	Type	Part No.
BFH040/F, BFH090/F, BFH120F, DFT022F, DFT044F, DFT085F, DFT086F, DFT126F, DFT127F, DFT128F	NZ	195232-3

Torque adjust tool



Model No.	Part No.
BFH040/F, BFH090/F, BFH120F, DFL020F, DFL061F, DFL062F, DFL063F, DFL082F, DFL083F, DFL122F, DFL123F, DFL125, DFL201F, DFL201R, DFL202F, DFL204F, DFL300F, DFL301F, DFL301R, DFL302F, DFL400F, DFL402F, DFL402R, DFL403F, DFL651F, DFT022F, DFT023F, DFT024F, DFT025F, DFT041R, DFT043F, DFT044F, DFT045F, DFT046F, DFT060F, DFT082F, DFT082R, DFT083F, DFT084F, DFT085F, DFT086F, DFT124F, DFT124R, DFT125F, DFT126F, DFT127F, DFT128F	765027-4

Ring 25

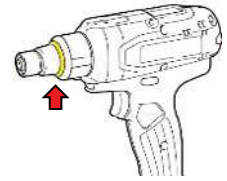

Model No.	Color	Part No.
DFT085F, DFT086F, DFT127F, DFT128F	Black	424977-9

Lock nut M28



Model No.	Color	Part No.
DFT023F, DFT024F, DFT025F, DFT045F, DFT046F, DFT060F	Black	457530-6

Protector



Model No.	Color	Part No.
BFH040/F, BFH090/F, BFH120F	Yellow	418423-2
DFT022, DFT041F, DFT041R, DFT043F, DFT044F, DFT045F, DFT046F, DFT082F, DFT082R, DFT083F, DFT084F, DFT124F, DFT124R, DFT125F, DFT126F	Blue	418424-0
	Red	418425-8
DFT023F, DFT024F, DFT025F, DFT045F, DFT046F, DFT060F	Clear	424984-2
DFL061F, DFL082F, DFL084F, DFL122F, DFL123F, DFL201F, DFL201R, DFL202F	Red	418065-2

For Clutch Case (A)

BFH040/F, BFH090/F, BFH120F DFT022, DFT041F, DFT041R, DFT043F, DFT044F, DFT045F, DFT046F, DFT082F, DFT082R, DFT083F, DFT084F, DFT124F, DFT124R, DFT125F, DFT126F	Blue	418743-4
---	------	----------

For Angle Head (B)

BFL300F, DFL300F	Blue	418746-8
------------------	------	----------

Cordless Tools

Keyless drill chuck



Model No.	Capacity	Thread size	With Package	Bulk
			Part No.	Part No.
DA331D	0.8 -10mm	3/8-24 UNF	196308-9	766007-3
DDA351	0.8 -10mm	3/8-24 UNF	---	766005-7
DF332D, DF333D, HP332D, HP333D	0.8 -10mm	3/8-24 UNF	---	763238-5
DDF343	0.8 -10mm	1/2-20 UNF	196309-7	766002-3
DF0300, HP0300	1.0 -10mm	1/2-20 UNF	---	766012-0
DDF453, DF457D, DF488D, DHP453, HP457D, HP488D	1.5 -13mm	1/2-20 UNF	196306-3	763260-2
DDF448, DDF458, DDF481, DHP448, DHP458, DHP481	1.5 -13mm	1/2-20 UNF	---	763252-1
DDF451, DHP451	1.5 -13mm	1/2-20 UNF	---	763191-5
DDF483, DHP483	1.5 -13mm	1/2-20 UNF	---	763241-6
AC Models				
6408, 6510LVR, DA3010F, DA3011	0.8 -10mm	3/8-24 UNF	192016-0	763132-1
DP4001, DP4003	1.5 -13mm	1/2-20 UNF	192956-2	---
DP4011, HP2050, HP2050F, HP2051, HP2051F, HP2070, HP2070F, HP2071, HP2071F	1.5 -13mm	1/2-20 UNF	194254-0	---
6300-4, DP4700	1.5 -13mm	1/2-20 UNF	192892-2	---



Drill chuck



*with Chuck key
 **without Chuck key
 ***without key with hex.socket head bolt M6X25 & nord-lock washer 6 x2
 jacobs taper No.3
 DC Models

Model No.	Drill chuck				Chuck key
	Capacity (mm)	Thread size	with Package Part No.	Bulk Part No.	
DDA350	1.5-10	---	---	763174-5	763415-9
DDA450Z	2.0-13	1/2-20 UNF	---	763183-4	---
DA001G, DDA460, DG001G, DG460D	2.0-13	---	---	763250-5	763251-3
UT131D	1.5-13	1/2-20 UNF	*196008-1	766016-2	763448-4

AC Models

Model No.	Drill chuck				Chuck key
	Capacity (mm)	Thread size	With Package Part No.	Bulk Part No.	
6501, DD2020, DP2010	6.5	3/8-24 UNF	---	763077-3	763418-3
	6.5	3/8-24 UNF	**192888-3	---	---
6407, 6510LVR	0.8-10	3/8-24 UNF	---	763136-3	---
HP1230	1.5-10	3/8-24 UNF	---	---	763415-9
6412	1.5-13	3/8-24 UNF	---	---	763418-3
6411 6412	1.5-13	3/8-24 UNF	---	---	763447-6
HP1630	1.5-13	1/2-20 UNF	*195081-8	763161-4	763441-8
HP1630, HP1640, HP1640F	1.5-13	1/2-20 UNF	*196008-1	766016-2	763448-4
DP4000, DS4011, DS4012, HP2050, HP2050F, HP2051, HP2051F, HP2070, HP2070F, HP2071, HP2071F	2.0-13	1/2-20 UNF	---	763183-4	---
6300-4, 6300T, 6301, 6305, DP4002, DP4700, DS4010, DS4011, DS4012, 8406, 8406C, 8416, HP1300S, HP2010N, HP2032, HP2050, HP2050F, HP2070, HP2070F	2.0-13	1/2-20 UNF	**192877-8	---	---
DA3010, DA3010F	1.5-10	---	---	763174-5	763415-9
6302H, 6303H, DP4000, DP4002	2.0-13	1/2-20 UNF	**193228-8 **193229-6	---	---
DP4010, HP2050, HP2050F, HP2051, HP2051F	2.0-13	1/2-20 UNF	*193067-6	763147-8	---
6300-4, DP4700, DS5000, HP2070, HP2070F	4.5-16	1/2-20 UNF	---	763066-8	763432-9
6304LR, DA4000LR	2.0-13	---	*** 193318-7	---	763432-9
6016	16	---	---	763011-3	763429-8
		(jacobs taper No.3)	---	---	---

Drilling / Fastening

Drill chuck assembly for Impact Driver



Type	Chuck Type	Part No.
Connect Bit 6.35-48 NZ	Keyless	192121-3
Connect Bit 6.35-48 NZ	---	192173-4

Angle attachment

(For drilling in close quarters, incorners, between joists and studs.)



Model No.	No Load Speed	Part No.
DS4010,DS4011, DS4012	High:800rpm Low:350rpm	STEX122177
DA4000LR	High:900rpm Low:400rpm	193316-1

Type 43 drill stand

For Neck diameter 43mm Models



Part No.

A-36712

Grip assembly



Model No.	Part No.
6906	122464-9
TW1000	122727-3

Extension handle

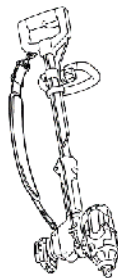

Model No.	Part No.
DTW700, DTW701, DTW800, DTW1001, DTW1002, TW001G, TW007G, TW008G	191G67-2

Shear wrench sleeve

For Model
6922NB DWT310



*Type F (for HEXA TECH (GFD France))

Bolt Size	Outer sleeve			Inner sleeve	
	Hex size	L (mm)	Part No.	L (mm)	Part No.
M16	27	35	764362-7	36	764416-0
		81	764367-7	82	*764421-7
		100	764406-3	100	764400-5
M20	32	37	764361-9	38	764417-8
		37	764361-9	38	*764422-5
		83	764363-5	84	764357-0
M20		100	764408-9	100	764402-1
M22,7/8"	36	39	153909-6	39	764418-6
		85	764364-3	85	*764423-3
M22,7/8"	1-7/16"	100	764410-2	100	764404-7
M22,7/8"		170	764365-1	170	764354-6
3/4"	1-1/4"	37	764361-9	38	764419-4
3/4"		83	764363-5	84	764353-8
3/4"		168	764366-9	169	764355-4

5/8"
For Model
6924N

Bolt Size	Outer sleeve			Inner sleeve	
	Hex size	L (mm)	Part No.	L (mm)	Part No.
M22	36	49	194033-6	48	194310-6
M24	41	49	194034-4	49	194311-4
7/8"	1-7/16"	49	194092-0	48	194310-6
1"	1-5/8"	49	194034-4	49	194312-2

Extension handle



Model No.	Part No.
DFR540, DFR550, DFR750 6840, 6841R, 6842, 6843, 6844	194500-1

Autofeed attachment set

Flat Tape Collated Screws size : 25-55mm



Model No.	Standard Equipment Bit	Part No.
DFS250, DFS452, FS2200, FS2300, FS4000, FS4200, FS4200A, FS4300, FS6200, FS6300, FS6300R	Phillips No.2 Square No.2	199078-9

Drilling / Fastening

Bits for Autofeed attachment set

For Attachment set 191G72-9, 191G73-7, 191G74-5



Model No.	Size	Part No.
DFS250, DFS452 FS2200, FS2300, FS4000, FS4200, FS4200A, FS4300, FS6200, FS6300, FS6300R	Phillips No.2 (5pcs)	199155-7

Magnetic bit holder Type MZ



(For 25mm insert bit (C-Form))

Model No.	Magnetic bit holder	
	Size	Part No.
DFS450, DFS451, FS2300, FS4000, FS4200, FS4300, FS6200, FS6300, FS6300R	6.35-60	784811-8
	6.35-76	784801-1

Socket bit

1 per pkg.

*For self drilling screw

**Magnetic socket bit

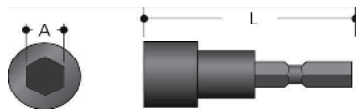

FS2700



Bolt Size	A (mm)	L (mm)	Type	Part No.
M5	8	55	NZ	784403-3
M6	10	55	NZ	784405-9

Front cap	
Size	Part No.
12	322070-2

Magnetic socket bit

1 per pkg.

*Non-magnetic socket bit

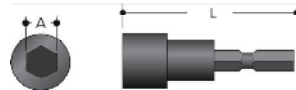

FS2500

FS2701



Bolt Size	A(mm)	L(mm)	Type	Part No.
M5	8mm	65	MZ	*784415-6
1/4"	3/8"	65	MZ	784802-9
M6	10mm	65	MZ	784806-1

Magnetic socket bit

DIN, E Form, M Type

*Non-magnetic socket bit

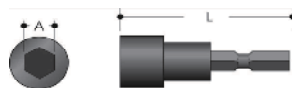

Bolt Size	A(mm)	L(mm)	Type	Part No.
L=50mm bit				
M5	8mm	65	MZ	*784415-6
1/4"	3/8"	65	MZ	784802-9
M6	10mm	65	MZ	784806-1

Impact Drilling / Demolition

Dust cup

(Dust collector assembly)
(Protects operator from dust and debris)



Bit Dia. (mm)	Part No.
6-14.5	421342-3
12-16	421664-1

Chuck adapter assembly (1/2"-UNC)

With screw M6 x 22



Part No.

D-14093

Drill chuck & Chuck key

(Use with chuck adapter)



Description	Part No.
Drill chuck (13mm)	192877-8
Chuck key	763432-9

Quick change drill chuck set (13mm)



	Model No.	Part No.
DC models	DHR243, DHR264	194079-2
AC models	HR2320T, HR2470T, HR2470FT, HR2630T, HR2631FT, HR2651T, HR2653T, HR2810T, HR2811FT	194079-2
	HR3210FCT	194568-7

Tool holder set



	Model No.	Part No.
DC models	DHR243, DHR264	194080-7
AC models	HR2320T, HR2470T, HR2470FT, HR2630T, HR2631FT, HR2651T, HR2653T, HR2810T, HR2811FT	194080-7

Drill chuck assembly (13mm)

(Chuck adapter assembly and Drill chuck)



*Inc.chuck key

Shank	Type	Part No.
SDS-PLUS	with key	122574-2
SDS-PLUS	with key	*194041-7
SDS-PLUS	keyless	122823-7
SDS-MAX	keyless	122829-5

Hammer carrier

For Model:
HM1812, HM1802, HM1810, HM1801



Part No.

D-54972



Impact Drilling / Demolition

Vacuum attachment



Model No.	Type	Part No.
HM1304/B, HM1306, HM1307C/CB, HM1317C/CB, HM1400, HM1500/B, HM1801, HM1802, HM1810, HM1812	With Vacuum hose set	197148-8
	Without Vacuum hose set	197168-2

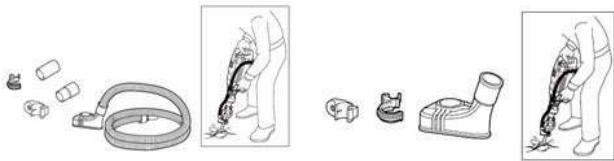

Model No.	Type	Part No.
HM1501, HM1502, HM1511, HM1512	With Vacuum hose set	191M20-4

Vacuum attachment

SDS-max 40/45mm class vacuum attachment
Drilling mode
Hammering mode

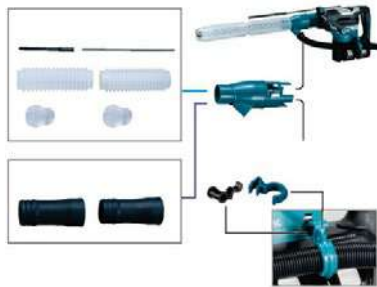

Model No.	Part No.
HR4001C, HR4002, HR4010C, HR4011C, HR4501C, HR4510C,	196074-8
HR5212C, HR5202C	196858-4

Sealing cap

For Dust extraction system set

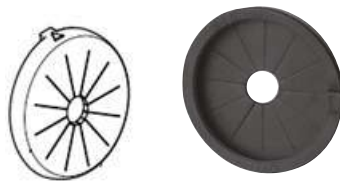

Dust Extraction System Set	Part No.
DX05, DX06, DX07, DX08, DX09, DX12, DX14, HR2652, HR2653, HR2653T, HR2663	424474-5

Blow-out Bulb

Ideal for blowing out chips and dust from drilled holes before setting anchor fasteners. The efficient design allows for quick debris removal. Bulb is designed for easy one handed operation.



Part No.
765009-6

Dust extraction system set

This system is designed to collect dust effectively with on-off operation of the tool's on-off trigger switch interlocked with this system.



Model No.	Dust Extraction System Set	Part No.
HR182D	DX05	199658-1
DHR242	DX01 DX06	195896-3 199561-6
DHR280, DHR282	DX08	199579-7
DHR281 DHR283	DX09	199583-6
HR3011F	DX10	191F95-1
HR001G, HR003G	DX12	191E52-3
HR002G, HR004G	DX14	191E58-1
HR007G, HR2652	DX15	191X39-9

Dust case

With filter



Model No.	Part No.
DX05	199595-9
DX06, DX07, DX08, DX09, DX12, DX14,	199555-1
HR2652, HR2653, HR2653T, HR2663	199586-0

Filter

HEPA Filter



Dust Extraction System Set	Part No.
DX01, DX06, DX07, DX08, DX09, DX10, DX11, DX12, DX14, HR2652, HR2653, HR2653T, HR2663	199557-7
DX05	199596-7

Oil supply & Grease vessel



Model No.	Type	Contents	Part No.
A	HM1306	Oil 100 ml	181118-7
B	Hammers (for bit)	Grease 30ml	188088-1
C		Grease 100ml	194683-7

Impact Drilling / Demolition

Side Grip for Hammer Drills

DC models



Model No. (Origin)	Item	Part No.
DHP481	With Thumb screw 	126413-8

Depth Gauge for Hammer Drills

(Stopper pole)



	Model No.	Part No.
DC models	DHP441, DHP448 DHP451, DHP454, DHP458, DHP481 DHP486, HP001G	122576-8
AC models	HP1630, HP1631, HP1640/F, HP1641/F, HP2050/F, HP2051/F, HP2070/F, HP2071/F	324219-0

Standard type side grip

*Side grip



Model	Standard type side grip	
	Part No.	
HR3540C, HR3541FC, HR4001C, HR4002, HR4010C, HR4011C, HR4501C, HR4510C, HR4511C	135265-6	
HR5000	273472-4	
HR006G, HR5202C, HR5212C	135629-4	

Dustcup set item



Model No.	Part No.
DHR165, DHR171, DHR182, HR140D, HR166D, HR1830, HR1840, HR1841F, HR2800, HR2810, HR2811F, HR2230, HR2460, HR2460F, HR2470, HR2475, DHR202, DHR241, DHR263	198362-9
DHR242, HR2650, HR2651, HR2652, HR2653, HR2661, HR2663, DHR281, DHR283, HR002G, HR004G, HR3012FC	195173-3
DHR243, HR2651T, HR2653T, HR2300T, HR2320T, HR2630T, HR2631FT	195179-1

Grip base set Item



Part No.	Item	Part No.
194581-5	Hex. Bolt M8X110	921919-9
194583-1	Grip base 20	419975-6
	Hex. Bolt M8X110	921919-9
194582-3	Grip base 20	419975-6
	Hex. Bolt M8X110	921919-9

Side Grip

(Hammer)



Model No.	Part No.
HR4001C, HR4002, HR4010C, HR4011C, HR4501C, HR4510C, HR4511C	134890-0
HR006G, HR5202C, HR5212C	135283-4
HM001G HM0870C, HM0871C	135332-7
HM001G, HM0870C, HM0871C	136362-1
HM1101C, HM1111C	134890-0
HM002G, HM1202C, HM1203C, HM1205C, HM1213C, HM1242C	135269-8
HM1214C	135283-4



Impact Drilling / Demolition

Hammer service kit

A: With Slide-Chuck System
B: With Swivel-Chuck System



Model No.	Part No.
DC Models	
DHR182	199544-6
DHR242, DHR281, DHR283, HR002G, HR004G	195833-7
DHR243	199233-3
BHR262, BHR262T, DHR263, DHR264, HR262D, HR262TD	195189-8
AC Models	
HK1820, HK1820L	195194-5
HM0810, HM0810T, HM0810B	193242-4
HM0860C	195204-8
HM0870C, HM0871C	195113-1
HM1100, HM1100C	193243-2
HM1202, HM1202C	193391-7
HM1203C, HM1205C, HM1213C, HM1214C	195114-9
HM1307C, HM1307CB, HM1317C, HM1317CB	195103-4
HM1802, HM1812	197127-6
HR2300, HR2600, HR2610	195105-0
HR2310T, HR2320T, HR2610T, HR2630T	195106-8
HR2601, HR2611F	195107-6
HR2611FT, HR2631FT, HR2651T, HR2653T	195108-4
HR2800, HR2810, HR2810T, HR2811F, HR2811FT	195206-4
HR2630, HR2650, HR2652	196968-7
HR2611FT, HR2631FT, HR2651T, HR2653T	195108-4
HR2631FT, HR2653	196967-9
HR2630T	195106-8
HR3540C, HR3541FC	195192-9
HR4001C, HR4002, HR4010C, HR4011C	195195-3
HR4501C, HR4510C, HR4511C	195210-3
HR5201C, HR5210C, HR5211C	195191-1



Cutting (New Material / Masonry)

Rip fence (Guide rule)

*Use with wing bolt M5 x 10 (P/N 924206-5)
 **Use with wing bolt M6 x 14 (P/N 265701-9)



Model No.	Part No.
4100KB*, 4100NB*, 4100NH*, 4101R*, 4101RH*, 4105KB*, 4131**, 4157KB, 5057KB	164095-8
CA5000	165447-6

Base set

(To set cutting depth)



Model No.	Part No.
4114, 4114S	165431-1

Portable band saw stand, Cover & Stand chain vise, Cover set

(For accurate square cutting operations)



Model	Description	Part No.
DPB182	Cover	197975-3
2107F	Cover	196325-9
2107F	Portable band saw stand	194026-3



Hook



Model	Description	Part No.
DPB183, DPB184	HOOK assembly	191G64-8

Side grip

(Handle)



Model	Thread Size	Description	Part No
DPB183	M8	Rubbierized grip	158237-4

Cutting wax for band saw



Part No.
191897-9

Cutting (New Material / Masonry)

Shear



Model No.	Item No.	Description	Part No.
DJS130, JS1300	1	For MILD STEEL : 1.3mm / 18Ga INOX : 1mm / 20Ga	792744-3
	2	---	792742-7
	3	---	792743-5
	2,5	1pc	725130-3
DJS800	1	2 pcs set	792536-0
	2	---	792537-8
	1	2 pcs set	792533-6
DJS160, DJS161, JS1601	2	---	792534-4
	1-3 set	---	191383-0
	1,2 set	---	792287-5
JS3201	---	Thickness gauge 1.0/1.5/2.0mm	762007-1

Nibbler

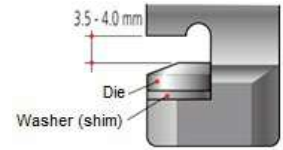

**To keep clearance of 3.5 to 4.0mm, use a washer(shim) or two under the die when installing a resharpened die.

Model No.	Item no.	Description	Part No
DJN160, DJN161, JN1601	1	Die	A-15051
	2	Punch	A-83951
	1	Die	792292-2
	2	Punch	792728-1
	---	Washer (shim)**	341796-7**
	3	Wrench	781019-5



Grinding / Sanding

Wheel guard

Bearing box type
 A: Triple notches
 B: Single notch
 C: Twin notches
 D: 5 notches

*Toolless type

**UP to 180mm size cup diamond wheel

***Inner flange 45CA/42CB/45CC is also necessary.

****Inner flange 47(P/N:122482-7) is also necessary.

*****Inner flange 47(P/N:126601-7) is also necessary.

*****Wheel Size Down 125mm → 115mm

*****Lo profile type

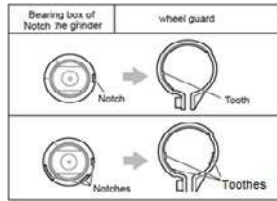

Wheel Size	Models	Bearing box type	for Abrasive cut-off wheel (Type:42)		Attachment for Abrasive cut-off wheel (Type:42)	Dust collection wheel guard for diamond wheel		Dust collection wheel guard for cup diamond wheel
			Type	Part No.		Type	Part No.	
100mm	---	Triple notches	Standard 100CK	122909-7	---	---	---	---
	---	Single notch	Standard 100	192626-3	---	A	198413-8	---
	9500N, 9500NB	Single notch	Standard 100	---	---	C	199295-1	---
	GA4050, GA4050R	5 notches	New Toolless 100C	162555-4*	---	A	192212-0	---
115mm	---	Triple notches	Standard 115CK	122910-2	199709-0	---	---	195239-9(EU)
	---	Single notch	Standard 115	122642-1		---	---	195237-3
	GA4550, GA4550R, GA4552, GA4552R	5 notches	New Toolless 115C	162556-2		---	---	---
125mm	GA5010, GA5020C, GA5021C, 9565C, 9565CV, 9565CVR, 9565P	Single notch	---	---	199710-5	B	192968-5	195237-3
	9005B, 9005BZ	Triple notches	Toolless 125CK	122905-5		C	196846-1	
			Standard 125CK	122911-0		A	198416-2	195239-9(EU)
			---	---		---	---	
	GA5050, GA5050R, GA5052, GA5052R	5 notches	New Toolless 125C	162557-0		---	C	191G06-2
150mm	GA6010, GA6020, GA6020C, GA6021, GA6021C, GA6040, GA6040C, GA6040R, 9566C 9566CR, 9566CV, 9566CVR, 9566PCV	Triple notches	Standard 150CK	122912-8	---	---	---	---
	GA7010C, GA7011C, GA7012C, GA7020, GA7020R, GA7020S, GA7021, GA7030, GA7030R, GA7030S, GA7031, GA7040, GA7040R, GA7040S, GA7050, GA7050R, GA7060, GA7060R, GA7061, GA7061R, GA7062, GA7062R, GA7063, GA7063R, GA7064	Triple notches	Standard 180CK	122914-4	---	D	198514-2	---
	GA7010C	Single notch	---	---	---	B	194303-3	195387-4 195388-2
230mm	GA9010C, GA9012C, GA9020, GA9020R, A9020S, GA9030, GA9030R, GA9030S, GA9031, GA9040, GA9040R, GA9040S, GA9050, GA9050R, GA9060, GA9060R, GA9061, GA9061R, GA9062, GA9062R, GA9063, GA9063R	Triple notches	Standard 230CK	122913-6	---	D	198440-5(EU)	---
	9069	Single notch	---	---	---	B	194044-1	---
	GA9020, GA9020, GA9020S, GA9030, GA9030S, GA9040S	Twin notches	---	---	---	B	194044-1	195387-4** 195388-2**
						D	198380-7	
	GA9020, GA9031, GA9040S, GA9050, GA9050R, GA9060, GA9060R, GA9061R, GA9062, GA9063R	Triple notches	Standard 230CK	122913-6	---	---	---	---
GA9020, GA9020S, GA9040S	Twin notches	---	---	---	D	198380-7****	195387-4** 195388-2**	

Grinding / Sanding

Cordless Models

**UP to 180mm size cup diamond wheel

***Inner flange 45CC (P/N:198678-2(EU) / 198675-8) is also necessary.

****Inner flange 45CA (P/N:198676-6) is also necessary.

*****Inner flange 42CB (P/N:198677-4) is also necessary

Wheel Size	Models	Bearing box type	for Abrasive cut-off wheel (Type:42)		Attachment for Abrasive cut-off wheel (Type:42)	Dust collection wheel guard for diamond wheel		Dust collection wheel guard for cup diamond wheel
			Type	Part No.		Type	Part No.	Part No.
100mm	DGA402	Single notch	Standard 100	192626-3	---	A (C)	198413-8	---
						C	199295-1	
	GA003G, GA006G, GA011G, GA014G, GA021G, GA024G, GA027G, GA030G	5 notches	New Toolless 100C	162555-4	---			
115mm	DGA450, DGA452, DGA454, DGA455, DGA456, DGA458, DGA461, DGA462, DGA463, DGA464, DGA467, DGA468	Triple notches	Standard 115CK	122910-2	199709-0	---	---	195239-9(EU)
	DGA452	Single notch	Standard 115	122642-1		---	---	195237-3
	GA004G, GA007G, GA012G, GA015G,	5	New	162556-2		---	---	---
125mm	DGA504, DGA505, DGA506, DGA508, DGA511, DGA512, DGA513, DGA514, DGA517, DGA518	Triple notches	Standard 125CK	122911-0	199710-5	A (CD)	198416-2	195239-9(EU)
			Toolless 125CK	122905-5		C (K)	---	
	GA005G, GA008G, GA013G, GA016G, GA023G, GA026G, GA029G, GA032G	5 notches	New Toolless 125C	162557-0		C	191G06-2	191F81-2
180mm	GA7010C, GA7011C, GA7012C, GA7020, GA7020R, GA7020S, GA7021, GA7030, GA7030R, GA7030S, GA7031, GA7040, GA7040R, GA7040S, GA7050, GA7050R, GA7060, GA7060R, GA7061, GA7061R, GA7062, GA7062R, GA7063, GA7063R, GA7064	Triple notches	Standard 180CK	122914-4	---	D (K)	198514-2****	---
					---	---	---	
230mm	DGA900, DGA901	Triple notches	Standard 230CK	122913-6	---	D (K-C) (K)	198440-5 (EU)***	---

Wheel guard for X-LOCK Models

Wheel Size	Models	Bearing box type	for Abrasive cut-off wheel (Type:42)		Attachment for Abrasive cut-off wheel (Type:42)	Dust collection wheel guard for diamond wheel		Dust collection wheel guard for cup diamond wheel
			Type	Part No.		Type	Part No.	Part No.
100mm	DGA419, DGA420	X-LOCK	X-LOCK 100C	162706-9	---	---	---	---
115mm	DGA469	X-LOCK	X-LOCK 115C	162707-7	199709-0	---	---	---
125mm	DGA519, DGA521	X-LOCK	X-LOCK 125C	162708-5	199710-5	C	191G05-4	---

Grinding / Sanding

Wheel guard for wire brush



For Models	Bearing Box Type	For Wire Cup Brush		For Wire Bevel Brush	
		Cup size	Part No.	Size	Part No.
100mm Angle grinder	Single notch	75mm	192454-6	85mm	192412-2
115mm Angle grinder		90mm	193066-8	---	---

Side Grip and Loop handle for Angle Grinder



Angle grinder
*with bolt & wrench

Wheel Size	Models	Thread Size	Standard	Rubbierized	Anti Vibration	Loop handle
100mm	GA4030, GA4030R, GA4031, GA4032, GA4034	M8	153504-2	158237-4	194514-0	---
	GA4030, GA4030R, GA4031, GA4034, GA4040, GA4040C, GA4041C, 9553B, 9553HB, 9553HN, 9556HB, 9556HN, 9556HP, 9556NB, 9556PB	M8	153489-2	158237-4	194514-0	---
	GA4050, GA4050R, GA4051R	M8	---	158237-4	194514-0	---
	9500N	M8	---	158237-4	194514-0	---
	GA4030	M8	153504-2	---	---	---
115mm	GA4530, GA4530R, GA4534	M8	153504-2	158237-4	194514-0	---
	GA4542C, GA4543C	M8	---	158237-4	194514-0	---
	GA4540, GA4540C, GA4540R, GA4541, GA4541C, GA4541R, 9554HN, 9557HN, 9557HNR, 9557HP, 9564CV, 9564CVR, 9564CR, 9564C, 9561CVR, 9561CR, 9564HR, 9564H, 9554HN, 9564P, 9564PC, 9564PCV, GA4550, GA4550R, GA4551R, GA4552, GA4552R, GA4553R	M8	153489-2	158237-4	194514-0	---
	GA4530, GA4534	M8	153504-2	---	---	---
	9564P	M8	153489-2	---	---	---
	9564PC, 9564PCV	M8	153489-2	158237-4	---	---
	GA5010, GA5020, GA5020C, GA5021, GA5021C	M8	153504-2	158237-4	194514-0	*194483-5
GA5030, GA5030R, GA5034, GA5040, GA5040C, GA5040R, GA5041C, GA5041R, GA5042C, GA5043C, 9555B, 9555HN, 9558HN, 9558HNR, 9558HP, 9558NB, 9558NBR, 9565P, 9558PB, 9565CV, 9565P, 9565PC, 9565PCV	M8	153489-2	158237-4	194514-0	---	
GA5050, GA5050R, GA5051R, GA5052, GA5052R, GA5053R	M8	---	158237-4	194514-0	---	
9565C, 9565CV, 9565H	M8	---	158237-4	194514-0	---	
9005B, 9005BZ, 9005N, 9015B	M12	152492-0	---	---	---	
GA5010	M8	153504-2	---	---	---	
GA5020	M8	153504-2	158237-4	---	---	
GA5020C	M8	---	158237-4	194514-0	*194483-5	
GA5030	M8	153504-2	---	---	---	
9565PC, 9565PCV	M8	153489-2	158237-4	---	---	
150mm	GA6010, GA6011, GA6020, GA6020C, GA6021, GA6021C	M8	153504-2	158237-4	194514-0	*194483-5
	GA6040, GA6040C, 9566CV, 9566PC	M8	153489-2	158237-4	194514-0	---
	GA6042C	M8	---	158237-4	194514-0	---
	9006N	M12	152492-0	---	---	---
	GA6010	M8	153504-2	---	---	---
	GA6020	M8	153504-2	158237-4	---	---
	GA6020C	M8	---	158237-4	194514-0	*194483-5
	GA6042C	M8	---	158237-4	---	---
9566PC	M8	153489-2	158237-4	---	---	

Grinding / Sanding

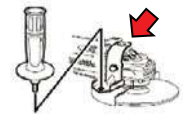

*with bolt, without grip

Wheel Size	Models	Thread Size	Standard	Rubbierized	Anti vibration	Grip Base For Cutting Operation
180mm	GA7911	M12	152492-0	---	---	---
	GA7010C, GA7011C, GA7012C, GA7012C, GA7050, GA7050R, 9067, 9617	M14	152539-0	---	194543-3	---
	GA7020, GA7020R, GA7020S	M14	152539-0	---	194543-3	*194684-5
	GA7030, GA7030R, GA7030S, GA7031, GA7040, GA7040R, GA7040S	M14	---	---	194543-3	*194684-5
	GA7060, GA7060R, GA7061, GA7061R, GA7062, GA7062R, GA7063, GA7063R, GA7064	M14	143486-6	---	194543-3	---
	GA7020, GA7021	M14	152539-0	---	---	*194684-5
	GA7050, GA7010C	M14	152539-0	---	---	---
	GA7060, GA7061, GA7064	M14	143486-6	---	---	---
230mm	GA9010C, GA9012C, GA9050, GA9050R, 9069 9069S	M14	152539-0	---	194543-3	---
	GA9020, GA9020R, GA9020S	M14	152539-0	---	194543-3	*194684-5
	GA9030, GA9030R, GA9030S, GA9031, GA9040, GA9040R, GA9040S	M14	---	---	194543-3	*194684-5
	GA9060, GA9060R, GA9061, GA9061R, GA9062, GA9062R, GA9063, GA9063R	M14	143486-6	---	194543-3	---
	GA9020	M14	152539-0	---	---	*194684-5
	GA9060	M14	143486-6	---	---	---

Side Grip and Loop handle for Cordless Angle Grinder



*Applicable models: DGA402

**Applicable models: DGA452

Wheel Size	Models	Thread Size	Standard	Rubbierized	Anti vibration
100mm	DGA402	M8	*153489-2	158237-4	194514-0
	DGA404, DGA405, DGA406, DGA408, DGA411, DGA412, DGA413, DGA414, DGA417, DGA418, DGA419, GA003G, GA006G, GA011G, GA014G, GA021G, GA024G, GA027G, GA030G	M8	---	158237-4	194514-0
115mm	DGA450, DGA452, DGA454, DGA455, DGA458	M8	**153489-2	158237-4	194514-0
125mm	DGA456, DGA461, DGA462, DGA463, DGA464, DGA467, DGA468, DGA469, GA004G, GA007G, GA012G, GA015G, GA022G, GA025G, GA028G, GA031G	M8	---	158237-4	194514-0
	DGA504, DGA505, DGA508	M8	---	158237-4	---
150mm	GA035G, GA036G	M8	---	158237-4	194514-0
180mm	DGA700, DGA701, GA037G	M14	143486-6	---	194543-3
230mm	DGA900, DGA901, GA038G	M14	143486-6	---	194543-3

Grinding / Sanding

Grip, Loop handle



Polisher / Sander / Concrete planer / Random orbit sander / Belt sander

	Models	Thread Size	Without Handguard For polishing	Standard	Rubbierized	Anti vibration	Loop handle	Front grip
Angle sander	SA4540C, SA5040C	M8	---	153489-2	---	194514-0	---	---
	SA7000, SA7000C	M14	---	152539-0	---	194543-3	---	---
	PK5001C	M8	---	153489-2	---	---	---	---
	PK5011C	M14	---	152539-0	---	---	---	---
Disc sander	GV5010, GV6010, GV7000, GV7000C	M10	---	152491-2	---	---	---	---
	9218SB	M12	---	152492-0	---	---	---	---
Polisher	9237C	M8	---	153489-2	---	---	---	---
	9237CB	M8	273514-4	153489-2	---	---	---	---
	PV7001C	M10	---	152491-2	---	---	---	---
	PV7000C	M10	273649-1	---	---	---	---	---
	9218PB, 9218PBL	M12	---	152492-0	---	---	---	---
Stone polisher	PW5000C, PW5001C	M8	---	153489-2	---	---	---	---
Concrete planer	PC5000C	M8	---	---	---	---	194483-5 *with bolt & wrench	---
	PC5001C	M8	---	---	---	---	---	273529-1
Random orbit sander	BO6040	M8	---	153489-2	---	---	---	---
	BO6050	M8	---	---	---	---	---	---
Belt sander	9031	M8	---	153489-2	---	---	---	---

Lock nut and Rubber pad for Angle grinder



Angle grinder & Cordless Angle grinder

Wheel Size	Spindle Thread	Rubber Pad			Sanding Lock Nut		Lock Nut Wrench	
		Pad Size (mm)	Max. Rpm	Part No.	Size (mm)	Part No.	Size	Part No.
100mm	M10 x 1.5	76	13,700	743009-6	30	224502-4	20	782401-1 / 782420-7
100mm (9500N)	M10 x 1.25	76	13,700	743009-6	30	224501-6	20	782401-1
115mm	M14 x 2 (DIN)	---	---	---	48	224515-5	28/35	782412-6 / 782407-9 782423-1
	5/8"-11 UNC	---	---	---	---	---	28	782412-6
125mm	M14 x 2 (DIN)	115	12,000	743015-1	48	224515-5	28/35	782412-6 / 782407-9 782423-1
	5/8"-11 UNC	115	12,000	743015-1	---	---	28	782412-6
150mm	M14 x 2 (DIN)	125	10,950	743016-9	48	224515-5	28/35	782412-6 / 782407-9 782423-1
	5/8"-11 UNC	125	10,950	743016-9	---	---	28	782412-6 / 782424-9
180mm - 230mm	M14 x 2 (DIN)	170	8,500	743012-7	48	224515-5	28/35	782412-6 / 782407-9
	5/8"-11 UNC	170	8,500	743012-7	---	---	28	782412-6
	M16	170	8,500	743012-7	48	224523-6	28/35	782412-6 / 782407-9

Grinding / Sanding

Lock nut, Rubber pad and Hook & loop Pad for Sanding or Polishing



Models	Spindle Thread	Rubber Pad							Hook & Loop Pad				
		Pad			Sanding Lock Nut		Lock Nut Wrench		Pad type	Pad Size (mm)	Max. Rpm	Part No.	
		Pad Size (mm)	Max. Rpm	Part No.	Size (mm)	Part No.	Size	Part No.					
Angle sander with water supply device	PK5011C	M14 x 2 (DIN)	115	12,000	743015-1	48	224515-5	28 / 35	782412-6 / 782407-9	---	---	---	---
		5/8"-11 UNC	115	12,000	743015-1	---	---	28	782412-6	---	---	---	---
PK5001C	M14 x 2 (DIN)	115	12,000	743015-1	48	224515-5	28 / 35	782412-6 / 782407-9	---	---	---	---	
Angle sander / Disc sander / Sander-polisher / Polisher	SA4540C	5/8"-11 UNC	---	---	---	---	---	28	782412-6 / 782424-9	Hook & loop	105	8,000	743062-2
	SA5040C	M14 x 2 (DIN)	115	12,000	743015-1	48	224515-5	28 / 35	782412-6 / 782407-9 / 782424-9 / 782423-1	Hook & loop	115	8,000	743061-4
	SA7000	M14 x 2 (DIN)	170	8,500	743012-7	48	224515-5	28 / 35	782412-6 / 782407-9	---	---	---	---
	SA7000C	M14 x 2 (DIN)	170	8,500	743012-7	---	---	28	782412-6	---	---	---	---
	GV7000	5/8"-11 UNC	170	8,500	743012-7	---	---	28	782412-6	---	---	---	---
	GV7000C	5/8"-11 UNC	170	8,500	743012-7	---	---	28	782412-6	---	---	---	---
	9218SB	M16	170	8,500	743012-7	48	224523-6	28 / 35	782412-6 / 782407-9	---	---	---	---
	9207SPB	M16	170	8,500	743012-7	48	224523-6	28 / 35	782412-6 / 782407-9	---	---	---	---
	9218PB	M16	170	8,500	743012-7	48	224523-6	28 / 35	782412-6 / 782407-9	---	---	---	---
	9218PBL	M16	170	8,500	743012-7	48	224523-6	28 / 35	782412-6 / 782407-9	---	---	---	---
Angle sander / Disc sander / Sander-polisher / Polisher	9237C	M14 x 2 (DIN)	170	8,500	743012-7	48	224515-5	28 / 35	782412-6 / 782407-9	Hook & loop	165	4,000	743053-3
	9237CB	5/8"-11 UNC	170	8,500	743012-7	---	---	28	782412-6	Hook & loop	165	4,000	---
	PV7001C	5/8"-11 UNC	170	8,500	743012-7	---	---	28	782412-6	Hook & loop	165	4,000	743054-1
	PV7000C	M16	170	8,500	743012-7	48	224523-6	28 / 35	782412-6 / 782407-9	Hook & loop	165	4,000	743054-1
Stone polisher	PW5000C	M14 x 2 (DIN)	---	---	---	---	---	---	---	Hook & loop	96	6,000	743080-0
	PW5001C	M14 x 2 (DIN)	---	---	---	---	---	---	---	Hook & loop	96	6,000	743080-0

Plastic pad for Disc sander GV6010 and GV5010



Models		Plastic Pad						
		Pad			Clamp screw		Countersunk washer	
		Pad Size (mm)	Max. Rpm	Part No.	Size	Part No.	Size (mm)	Part No.
Disc sander	GV5010	120	5,000	743025-8	M8x20	265812-0	35	253951-8
	GV6010	120	5,000	743025-8	M8x20	265812-0	35	253951-8

Sanding pad for Twist-on/twist-off system



Models	Rubber pad				
	Pad type	Thread size	Pad Size (mm)	Max. Rpm	Part No.
DPV300, PV301D	For Twist-on/ Twist-off system	1/4"-20 UNC	50	16,000	743124-6

Grinding / Sanding

Sanding pad for Twist-on/twist-off system

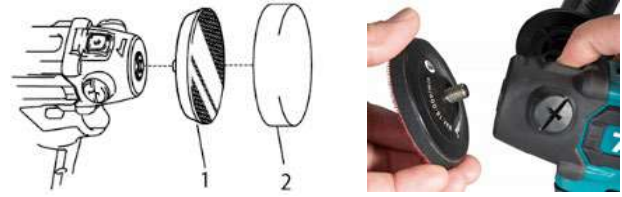

Models	1. Hook & Loop Pad					2. Polishing Pad		
	Pad Type	Thread Size	Pad Size (mm)	Max. Rpm	Part No.	Pad Type	Size (mm)	Part No.
DPV300, PV301D	Hook & loop	5/8"-24 UNF	75	16,000	743125-4	Sponge pad for applying wax Color : White	80	191N91-7
						Sponge pad for polishing Color : Yellow	80	191N90-9
						Wool pad (For high gloss polishing)	80	191N92-5

Lock nut wrench, Lock nut release socket

Lock nut wrench



Lock nut release socket
(Square drive :1/2"(12.7mm))



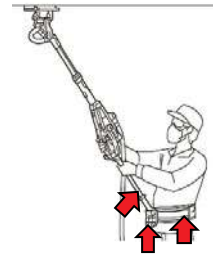

Type	For Model	Size	Part No.
Lock nut wrench	All 100mm	20	782401-1
	All 100mm	20	782420-7
	115 / 125mm	35	782423-1
	DIN & Old type	28	782412-6
	180 / 230mm	35	782407-9
Lock nut release socket	180 / 230mm	35	782034-2
	180 / 230mm	35	194305-9

Extension Handle, Holder, Belt set for DSL800 & DSL801



Description	Part No.
Extension Handle, Holder & Belt 3pcs set	199937-7

Dust cover set / Dust collect cover / Protector



Model/ Item	Description	Part No.
PW5000C 	Dust cover set	194233-8
PK5001C 	2 Repair brush short	743333-7
	3 Repair brush long	743332-9
PK5011C 	2 Repair brush short	743333-7
	3 Repair brush long	743332-9

Tool Bag for DSL800 & DSL801



Part No.
195638-5

Repair brush for Drywall sander or Concrete planer or Dust collect cover

Model No.	Description	Item no.	Part No.
125mm(5") 	For models PC5000C & PC5001C	1+2	194921-7
		1	443144-7
		2	443145-5
125mm (5") set 	For model PC5010C For dust collect cover 125mm(5") set P/N:195236-5, 195237-3, 195238-1, 195239-9, 196575-6, 195774-7, 195775-5, 196587-9 and 191F81-2	1	743332-9
		2	743333-7

Lock nut for Concrete planer

Models	Spindle Thread	Arbor Size (mm)	Inner Flange		Lock Nut Wrench	
			Size	Part No.	Size	Part No.
PC5000C PC5001C	M14 x 2 (DIN)	22.23	---	---	35	782407-9
	5/8"-11 UNC	22.23	---	---	28	782412-6
PC5010C	M14 x 2 (DIN)	22.23	42	224415-9	35	782407-9
	5/8"-11 UNC	22.23	45	224399-1	28	782412-6

Grinding / Sanding

Dust cover attachment set



Model No.	Qty.	Part No.
DPV300, PV301D	1pc (2pcs will be used)	422613-1
DGA404, DGA406, DGA408, DGA411, DGA413, DGA414, DGA417, DGA518, DGA419, DGA454, DGA458, DGA461, DGA462, DGA463, DGA464, DGA467, DGA468, DGA469, DGA504, DGA505, DGA506, DGA508, DGA511, DGA512, DGA513, DGA514, DGA517, DGA518, DGA519, DSC251	Dust cover L	455449-3
	Dust cover R	455450-8
DGA700, DGA701, DGA900, DGA901	-	457620-5
GA003G, GA004G, GA005G, GA006G, GA007G, GA008G, GA011G, GA012G, GA013G, GA014G, GA015G, GA016G, GA035G, GA036G	1pc (2pcs will be used)	422563-0
GA021G, GA022G, GA023G, GA024G, GA025G, GA026G, GA027G, GA028G, GA029G, GA030G, GA031G	-	422610-7
GA4050, GA4050R, GA4051R, GA4550, GA4550R, GA4551R, GA4552, GA4552R, GA4553R, GA5050, GA5050R, GA5051R, GA5052, GA5052R, GA5053R	3pcs. set	199514-5
9562CH/CVH, 9564HR, 9565C/CR/CV/CVL/CVR/HR, 9566CV GD0800, GD0800C, GD0810C	3pcs. set	193903-6
GA5010, GA5020/C, GA6010, GA6020/C	2pcs. set	194482-7
GA5021, GA5021C, GA6021, GA6021C, GA7010C, GA7012C, GA9010C, GA9012C, PC5000C, PC5001C, SA7000, SA7000C	2pcs. set	193956-5
GA7020/R/S, GA7021, GA7030/R/S, GA7031, GA7040R/S, GA9020/R/S, GA9030/R/S, GA9031, GA9040R/S	2pcs. set	194289-1
GA7050/R, GA9050/R, GS5000, GS6000	2pcs. set	195059-1

Sleeve 18

(For centering pads)

For Model:

9237C/CB, 9227C/B, PV7001/C, PV7000C, SA7000C

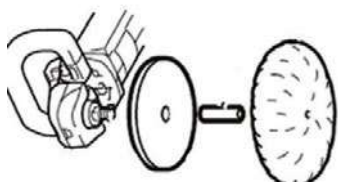

Part No.

262542-4

Hook & loop pad

Use with pre-punched abrasive disc.



Model No.	Size	Type			Part No.
DSL800, DSL801	220mm	Soft	black	hook & loop pad (1+2 set)	199938-5
	210mm	Medium	gray	hook & loop pad (1+2 set)	199939-3
	210mm	Hard	gray	hook & loop pad (1+2 set)	199940-8

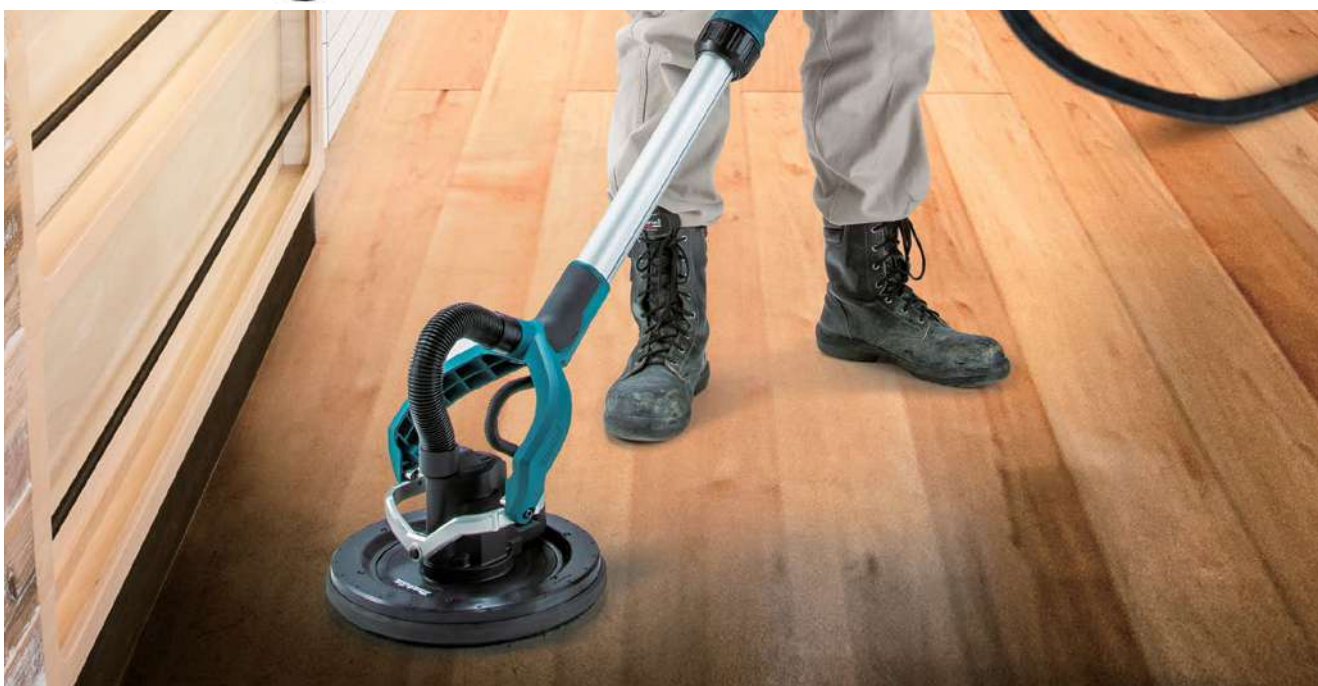

Grinding / Sanding

Head cover



Model No.	Part No.
9564CVL, 9565CVL, 9565CLR, PW5000C, PW5001C, PK5001C	417322-5

Collet cone, Collet nut and Wrench size



Model No.	Size	Collet Cone	Collet Nut	Wrench Size
		Part No.	Part No.	

DC models

DGD800, DGD801	3mm	763669-8	763668-0	13mm
	6mm	763670-3		19mm

AC models

906, 906H	3mm	763627-4	---	10mm 17mm
	6mm	763620-8		
	1/8"	763626-6		
	1/4"	763625-8		
GD0600, GD0601	3mm	763627-4	763664-8	13mm x2
	6mm	763620-8		
	1/8"	763626-6		
	1/4"	763625-8		
GD0603	3mm	763627-4	763236-9	10mm x2
	6mm	763620-8		
	1/8"	763626-6		
	1/4"	763625-8		
GD0602	3mm	763669-8	763668-0	13mm x2
	6mm	763670-3		
GD0800, GD0800C, GD0810C, GD0801C, GD0811C	6mm	763646-0	763645-2	13mm 19mm
	1/4"	763650-9		

Collet cone & nut set

GD0800, GD0800C, GD0810C, GD0801C, GD0811C	6mm	193012-1	13mm 19mm
	8mm	192988-9	
	1/4"	193143-6	

Side handle set



Model No.	Part No.
GD0800/C, GD0801C, GD0810C, GD0811C	193141-0

Belt sander plate



Model No.	Steel Plate	Cork Rubber Plate	Carbon plate
	*Include Cork Rubber Plate	For Use With Carbon Plate or Steel Plate.	
	Part No.	Part No.	
9401, 9402	342328-3	421093-8	423029-3
9403	---	421093-8	424057-1
9404	*151751-9	193202-6	193201-8
9924DB	341705-6	423035-8	423036-6
9910, 9911	344586-7	---	---
9920	---	193200-0	193198-1

Arm



Model No.	Belt Size	Item	Part No.
DBS180, 9032	6 x 533	Arm 6 Assembly	125157-7
	9 x 533	Arm 9 Assembly	125158-5
	13 x 533	Arm 13 Assembly	125159-3

Stand set



Model No.	Belt Size
DBS180, 9032	193618-5

Dust collection

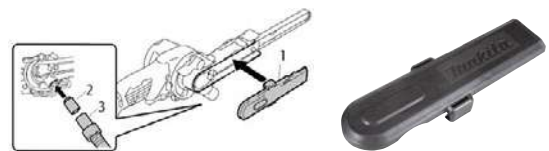

Model No.	Belt Size	Item	Part No.
DBS180, 9032	1	Dust Cover Set	191N60-8
	2	Dust Nozzle Assembly	122652-8

Grinding / Sanding

Punch plate

For conventional type of abrasive paper without pre-punched holes

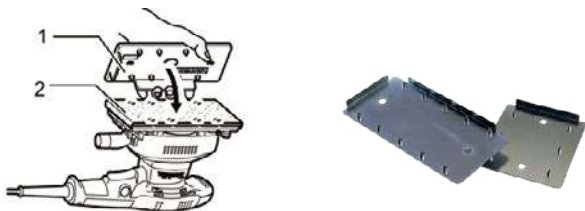

1. Punch plate
2. Abrasive paper without pre-punched holes

Model No.	Material	Part No.
BO3710	METAL	192989-7
BO4555, BO4556, BO4557, BO4558	PLASTIC	450066-4

Pad complete



Model No.	Description	Part No.
BO4900, BO4900V, BO4901	For use with Abrasive paper or clamping type paper	193523-6
	For use with Hook & loop type paper	193521-0



Dust box assembly, Paper dust bag and Filter set Dust Bag



Model No.	Part No.
9046	152456-4
BO3710, BO3711	140115-2

Dust box assembly, Paper dust bag and Filter set

*w/o mark of origin



Model No.	Item	Part No.
DBO140, DBO180, BO4555, BO4556, BO4557, BO4558, BO4565, BO4566, BO5030, BO5031, BO5040, BO5041	Dust box assembly (with paper dust bag 1pc)	135246-0
	Paper dust bag (5pcs./set)	194746-9
DBO140, DBO180, BO3710, BO3711, BO4555, BO4556, BO4557, BO4558, BO4565, BO4566, BO5030, BO5031, BO5040, BO5041	Filter set (5pcs./set) (Non-woven fabric)	*195133-5

Sawing

Ring

(For 5/8" = 15.88 mm spindle)
*With milled edge.



Outer Dia. (mm)	Hole Dia. (mm)	Thickness (mm)	Per pkg.	Part No.
25	15.88	4	1	257022-3

Holder

(For 5/8" = 15.88 mm spindle)
*With milled edge.

Model No.	Item	Part No.	
DLS110, DLS111, DLS112, LS1019/L		1	326978-2
		3	961015-1
DLS600, LS1030N, LH1040/F		1 x2 2 x2 set	192621-3
		1	322312-4
		2	265708-5
DLS713, DLS714, LS0714/F/FL/L		1	322312-4
		2	251887-5
LS0815FL		1	JM23000127
LS1219, LS1219L		1	327095-1
		3	961015-1
LS1221		2	251887-5

Vertical vise assembly & Horizontal vise assembly

Vertical vise assembly



Horizontal vise assembly



Model No.	Part No.
Vertical vise assembly DLS110, DLS111, DLS112, LS1019, LS1019L, LS1219, LS1219L	126617-2
DLS713, DLS714, LS0714, LS0714F, LS0714FL, LS0714L	122571-8
LS1017L, LS1018L, LH1201FL	JM23100502
LS1040, LS1040F, LH1040, LH1040F	122536-0
Horizontal vise assembly DLS110, DLS111, DLS112, LS1019, LS1019L, LS1219, LS1219L, LS1221, LH1201FL	122470-4
DLS713, DLS714, LS0714, LS0714F, LS0714FL, LS0714L	122567-9
LS1017L, LS1018L	122930-6
LS1030N, LS1040, LS1040F, LS1045, LS1440, LH1040, LH1040F	122563-7

Set plate

(For uniform cutting width)

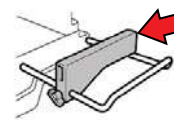

Model No.	Part No.
DLS600, DLS713, DLS714, LS0714, LS0714F, LS0714L, LS0714FL, LS1030N, LS1040, LS1040F, LS1045, LH1040, LH1040F	122472-0



Sawing

Rod 12 (Item No.1) / Holder assembly (Item No.2)

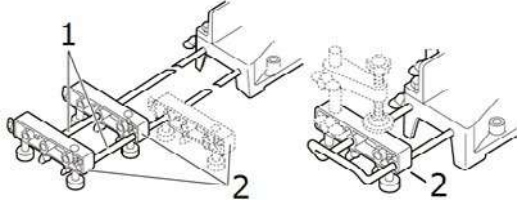

Model No.	Item	Qty	Part No.
LS1030N, LS1040/F, LS1045, LH104/F	2	1 set	122446-1

Guide rule

(Rip fence)



Model No.	Part No.
DCS550, DCS551, DCS553, DHS630, DHS660, DHS661, DHS680, DHS710, DHS711, DHS782, DHS783, DSS500, DSS501, DSS610, DSS611, 4191D, 5093D, 5094D, HS300D, 5005BA, 5007F, 5007FA, 5007MG, 5007MGA, 5007N, 5007NB, 5007NF, 5008MG, 5008MGA, 5606B, 5704R, 5740NB, 5800NB, 5806B, HS6100, HS6101, HS6600, HS6601, HS7000, HS7010, HS7010, HS7100, HS7101, HS7101, HS7600, HS7601, HS7610, HS7611	164095-8
DSP600, DSP601, SP6000	165447-6
HS0600, N5900B, 5902B,	164367-1
5103N, 5201N, 5201NA, 5402, 5402NA, 5430A, 5431A	164019-4

Rip fence assembly



Model No.	Part No.
2703	122556-4
LH1201FL	JM23300008

Angle rule assembly (Miter gauge)

*Sliding guide



Model No.	Part No.
2703	122555-6
2712	JM27110005

Belt sanding attachment set

Use a sanding belt that is 2,240 mm long and 20 mm wide or less.



Model No.	Part No.
LB1200F	JM21000330

Stand: A



Model No.	Part No.
MLT100, MLT100N, 2702, 2703	JM27000300

Stand: B



Model No.	Part No.
All Slide Compound saw, Miter saw and Table Top Miter Saw	WST07
All Slide Compound saw, Miter saw and Table Top Miter Saw	WST06

Stand: C



Model No.	Part No.
All Slide Compound saw, Miter saw and Table Top Miter Saw	WST05

Guide rail



Overall length (m)	Part No.
1.0	199140-0
1.4	194368-5
1.9	194925-9
3	194367-7

Repair Parts Guide Rail	Part No.
Seat 10m set (For upper plastic tape repair)	194416-0
Rubber Seat 10m set (For lower rubber tape repair)	194417-8
Splinter guard seat 1.9m	194910-2
Splinter guard seat 3.0m	194419-4

Guide rail Joint connector 2pcs set



Part No.
198885-7 (EU)

Sawing

Clamp set

(Use with Guide rail)



Type	Part No.
A: Standard	194385-5
B: Quick	199826-6



Blade clamp assembly

(For use of 6.35mm universal shank blades)



Model No.	Part No.
4300BA, 4300BV	132276-260

Bevel guide set

Adjustable angle of Guide Rail

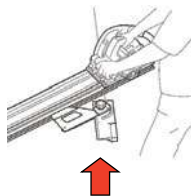

Part No.
196664-7

Dust nozzle

(Vacuum head)

Please see Suction system chart.



Model No.	Part No.
DJV180, 4350T/CT/FCT, 4351T/CT/FCT	417853-4
DJV181, DJV182	126331-0

Dust cover & Dust nozzle

Dust cover



Dust nozzle

Model No.	Item	Part No.
JV102D, JV103D	Dust nozzle	457801-1

Circular guide assembly



Model No.	Part No.
4300BA, 4300BV, 4301SB	123030-5

Guide Rail Adaptor

Type	A	B	C	D	E	F	G
	Circular saw			Jig saw		Router Trimmer	Cutter
Models	DHS680	DHS630 HS6100 HS6101 HS7100 HS7101	DHS660 DHS661	DJV141, DJV142, DJV180, DJV181, DJV182 4350CT 4350FCT 4350FT 4350T 4351CT 4351FCT 4351T	DJV141 DJV142 DJV180 DJV181 DJV182 4350CT 4350FCT 4350FT 4350T 4351CT 4351FCT 4351T	*DRT50 3612BR RP0900 RP0910 RP1110C RP1800 RP1800F RP1801 RP1801F RP2300FC RP2301F	DCC500 DCC501 4100KB, 4100NH2
Part No.	196953-0	197252-3	199232-5	197252-3	193517-1	194579-2	198673-2

* Use with Plunge base assembly (P/N:195563-0 EU:196094-2)

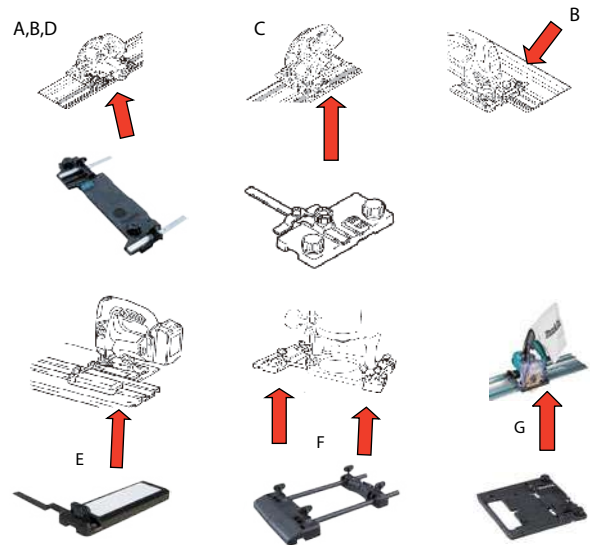

Guide rule set

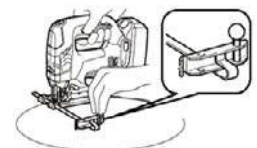

Model No.	Part No.
DJV180, DJV181, DJV182, 4350T/CT/FCT, 4351T/CT/FCT	193516-3
JV100D, JV101D, JV102D, JV103D, JV143D, JV183D, 4326/M, 4327/M, 4328, 4329, JV0600	192732-4

Rip fence

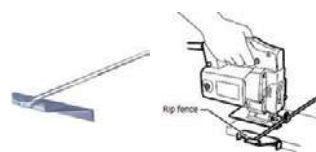

Model No.	Part No.
4300BA, 4300BV	164113-2

Planing / Routing

Blade gauge assembly

*With Poly bag & header



Model No.	Part No.
DKP180, DKP181, KP0800, KP0810/C, N1900B, N1923B, 1002BA, 1100, 1902, 1911B, 1912B	*191C19-9 123062-2 122695-0
1804N, 1805N	123009-6

Socket wrench 9



Model No.	Part No.
DKP180, DKP181, KP312, KP0800, KP0810/C, N1900B, N1923B, 1002BA, 1100, 1804N, 1805N, 1806B, 1902, 1911B, 1912B	782209-3
2012NB	782203-5

Set plate

*2 per pkg.



Model No.	Part No.
DKP180, DKP181, KP0800, KP0810/C, N1900B, N1923B, 1100, 1902	*193540-6

Sharpening holder assembly & Dressing stone

Sharpening holder assembly

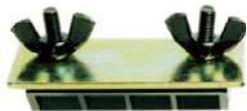

Model No.	Part No.
DKP180, DKP181, KP0800, KP0810/C, N1900B, N1923B, 1100, 1902	191C17-3 123004-6
1804N, 1805N, 1806B	123006-2
1002BA, 1911B 1912B	123055-9

Dressing stone

For HSS planer blade

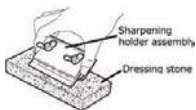

Size(mm)	Grit	Part No.
150	WA1200	794061-7
150	GC1200	D-17756
180	WA1200	794060-9

Edge fence (Guide rule)

*with screw



Model No.	Part No.
1100	161046-2
1804N, 1805N	191454-3
N1900B, N1923B, 1911B	191455-1
N1900B, N1923B, KP0800, DKP180	195055-9
DKP181	191C23-8
KP0810/C	*122785-9
N1900B, N1923B, KP0800, DKP180, DKP140	*123060-6

Extension guide set



Model No.	Part No.
DKP180, DKP140, 1911B, N1900B, N1923B, KP0800	191725-8

Chamfering rule assembly

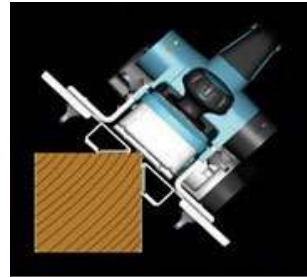

Model No.	Part No.
KP0810/C	122791-4
DKP181	191C22-0

Depth guide



Model No.	Part No.
DKP181, KP0810/C, N1923B	342390-8

Hood set

Outer dia. 76 mm

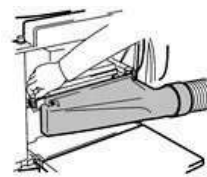

Model No.	Part No.
2012NB	193036-7

Magnetic holder

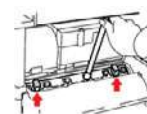

Model No.	Part No.
2012NB	762014-4

Planing / Routing

Trimmer guide assembly

* Use with Plunge base assembly

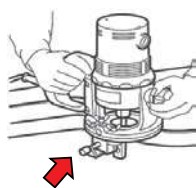

Model No.	Part No.
3707/F/FC, 3708/F/FC, 3709, 3710, N3701, RT0700C	122703-7
3600H, 3601B	122343-1
3612BR, RP1800/F, RP1801/F, RP2300FC, RP2301FC	123022-4

Straight guide assembly

(Straight guide)

A: Straight guide with micro adjustment



* Use with Plunge base assembly (P/N:195563-0 EU:196094-2)

Model No.	Type	Material	Part No.
3709, 3710	-	-	122704-5
3600H, 3601B	-	-	123029-0
3612BR, RP1800/F, RP1801/F, RP2300FC, RP2301FC	-	-	342428-9
RP0900, RP0910, RP1110C, *RT0700C	-	-	164834-6
3612BR, RP0900, RP0910, RP1110C, RF1100, RF1101, RD1100, RD110, RP1100, RP1101, RP1800/F, RP1801/F, RP2300FC, RP2301FC, *RT0700C	A	Steel	193312-9
*DRT50, RP1800/F, RP181/F, RP2300FC, RP2301FC, RP0900, RP0910, RP1110C, *RT0700C	A	Alumi w/o mark of origin	195136-9

Guide holder assembly



Model No.	Part No.
3612BR	122256-6
RP1800/F, RP1801/F, RP2300FC, RP2301FC	122700-3

Angle guide for plate joiner



Model No.	Part No.
DPJ180, PJ7000	123149-0

Biscuit for plate joiner (100 pcs. in set)

- Premium quality
- Select cut size
- High strength
- Finely ground edges
- Compressed beachwood



Model No.	Type	L x W(mm)	Part No.
DPJ180, PJ7000	#0	47 x 15	A-16922
	#10	53 x 19.5	A-16938
	#20	60 x 23.5	A-16944

Lock nut wrench for plate joiner



Model No.	Part No.
DPJ180, PJ7000	782401-1



Planing / Routing

Circular guide set



Model No.	Part No.
3706	193448-4

Collet cone & Collet nut

*With Poly bag & header



Model No.	Wrench Size	Collet Cone		Collet nut
		Size	Part No.	Part No.
DCO180, DCO181	17mm	3mm	763679-5	763258-9
		6mm	763678-7	



Model No.	Wrench Size	Collet Cone		Collet Nut
		Size	Part No.	Part No.
3706	17mm	6mm	763607-0	763606-2

Collet cone & Collet nut

Trimmer



Model No.	Wrench Size	Collet Cone		Collet Nut
		Size	Part No.	Part No.
3700B, 3701, 3703, 3707/F/FC, 3708/F/FC, 3709*, 3710*	10mm 17mm	6mm	763607-0	763606-2
		1/4"	763608-8	
3703, 3709, 3710	10mm 17mm	1/4"	763663-0	763661-4
DRT50, RT0700C	13mm 22mm	6mm	763636-3	763615-1
		8mm	763618-5	
		1/4"	763637-1	
		3/8"	763619-3	

Collet sleeve



Model No.	Collet Size	Bit Size	Part No.
RP1800, RP1800F RP1801, RP1801F RP230FC, RP231FC 3600H, 3601B 3612, 3612BR 3612C	1/2"	1/4"	763803-0
	1/2"	3/8"	763805-6
	1/2"	10mm	763806-4
	12mm	6mm	763801-4
	12mm	8mm	763804-8
	12mm	10mm	763807-2
	12mm	1/4"	763808-0

Router



*with header & poly bag

Model No.	Wrench Size	Collet Cone		Collet Nut
		Size	Part No.	Part No.
3600H, 3612, 3612BR, 3612C	13mm 24mm	12mm	763628-2	763629-0
		1/2"	763622-4	
RP0900	13mm 22mm	6mm	763636-3	763615-1
		8mm	763618-5	
		1/4"	763637-1	
		3/8"	763619-3	
RP1800, P1800F, RP1801, P1801F, RP230FC, RP231FC	24mm	12mm	763628-2	763674-5
		1/2"	763622-4	



Model No.	Wrench Size	Collet Cone		Collet Nut
		Size	Part No.	Part No.
4403	10mm 17mm	1/4"	763663-0	763661-4

Templet guide (Metric size)

*for fast production of complicated shapes by using templet
**DRT50, RT0700C : Use with Plunge base assembly



Model No.	Type	A (mm)	B (mm)	C (mm)	Part No.
DRT50, 3707/F/FC, 3708/F/FC, 3709, 3710, N3701, RT0700C,		8	10	9.5	*343577-5
DRT50**, 3612BR, RP0900, RP1800/F, RP1801/F, RP230FC, RP2301FC, RT0700C**		7.7	9.5	11.5	164379-4
		9	11	13	164775-6
	14.5	16	13	344364-5	
		18	20	13	164393-0
		24	27	13	164470-8
		25	29	15	163080-8
27	30	13	164471-6		

Planing / Routing

Model No.	Type	A (mm)	B (mm)	C (mm)	Part No.
RP0910, RP1110C		7.7	9.5	11.5	193330-7
		9	11	11.5	193331-5
		10.5	12	14	193332-3
		14.5	16	11.5	193334-9
		18	20	13	193335-7
		22	24	13	193340-4
		24	27	13	193336-5
		25	29	13	193337-3
		27	30	13	193338-1

Templet guide (Metric size)

Model No.	Type	A (mm)	B (mm)	C (mm)	Part No.
3600H, 3601B		11.1	12.7	14.3	321472-9
		10.9	12.7	8	323449-0
		14	16	8	323018-7
		14	16	14.5	321308-2

Templet guide adapter 30

(For B & D, Porter-Cable two-piece templet guide)

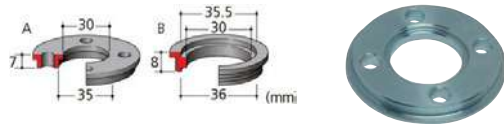

Nut M30
Part No. 252627-4

Templet guide adapter 30
Type A or Type B

Templet guide 25
Part No. 321812-1

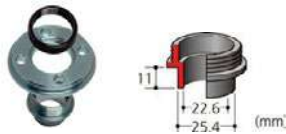

Plunge base assembly (P/N:195563-0 (EU:196094-2)) is also necessary.

Model No.	Type	Part No.
DRT50**, 3612BR, RP0900, RP1800/F, RP1801/F, RP2300FC, RP2301FC, RT0700C**	A	321492-3

Trimmer base assembly

A: Transparent base
B: For chamfering



Model No.	Bit Size	Part No.
3700B, N3701, 3703, 3704, 4403	-	122202-9
	A: Transparent base	122238-8
	B: For chamfering	STEX122390
3709, 3710	A: Transparent base	194267-1

Base for DRT50 & RT0700C

Able to meet a wide range of needs with the Motor unit and the following various attachments

Item	Per Pkg.	Part No.
Trimmer base assembly 	1	196613-4
Trimmer base plate 	1	196924-7
Grip attachment set 	1	EU:199089-4
Trimmer base assembly clear 	1	199090-9
Plunge base assembly Optional Fine adjusting straight guide can be used 	1	195563-0
Plunge base plate 	1	450819-1
Tilt base assembly Tilting capacity: -30° to 45° 	1	198987-9
Offset base assembly 	1	EU:195562-2













Able to trim close to wall and tight corners with a bit set in offset position. Distance 18.5mm from the edge to the center of bit

Others

Heat gun accessories

For Model: HG6031V, HG6030, HG5030, HG6530V, HG6531C





Shape		Part No.
Glass protection nozzle		PR0000028
Wide-slot nozzle		PR0000029
Reflector nozzle		PR0000030
Reduction nozzle 20		PR0000031
Overlap welding nozzle		PR0000032
Solder sleeves reflector		PR0000033
Welding nozzle		PR0000034
Pressure roller		PR0000035
Welding rods	ABS	PR0000036
	HDPE	PR0000037
	PP	PR0000038
Speed welding nozzle		PR0000039
Scraper		PR0000040
Scraper set		PR0000041
Scraper		PR0000042



Rechargeable Green Multi Line Laser accessories

For Model
SK312GD / SK209GD
*Thread size: W5/8

Shape		Part No.
Tripod 1800 *Thread size: W5/8		TK0LM4001F
Tripod 2900 *Thread size: W5/8		TK0LM5030F

Carbon Brush



Carbon Brush	Part Number	Model								
CB-1	181019-9	903								
CB-51A	B-80232	1902	3700B	4300BV	6013BR	6016	6300NB			
CB-55	181026-2	8416	JR3000V							
CB-55A	B-80248									
CB-64	191627-8	6412	6413	6510LVR	9035	906	BO3710	BO4540	DP4700	GD0603
CB-64A	B-80254	GV6010	JV0600K							
CB-65	191628-6	6905B	906H	JS1600	JS1670					
CB-65A	B-80260									
CB-70	191914-5	6501								
CB-70A	B-80276									
CB-85	191998-3	HP1630								
CB-85A	B-80282									
CB-100A	B-80298	1100	6906	9045B	9215SB	9218SB	9924DB	JN3200	JS3200	PC1100
CB-106	194976-2	1911B	3620	RP0900	UT1301					
CB-106A	B-80313									
CB-132	191972-1	UC3520A	UC4020A	UC3541A	UC4041A					
CB-153	181044-0	1804N	1805N	2012NB	2416S	3501N	3600H	3601B	3612BR	4107R
CB-153A	B-80329	5008B	5008MG	5016B	5103N	5201N	5401N	5402	6910	9105
		9401	HS0600	LF1000	LS1013	LS1016	LS1019L	LS1040	LS1212	LS1214
		LS1216	LS1219L	LS1440	N5900B	TW1000	UC3530A	UC3531A	UC4030A	UC4051A
CB-173	195483-8	VC2510L	VC3210L							
CB-203	191953-5	2414NB	3612C	HW1200	HW1300	LC1230	LW1400	LW1400	RP1801	
CB-203A	B-80341									
CB-253	194547-5	PC5000C								
CB-303	191963-2	2107F	4100NH	4100NH3Z	4131	5606B	5740NB	5806B	9015B	9016B
CB-303A	B-80379	9227C	9237C	CA5000	DA4000LR	GA5010	GA5020	GA6010	HS7010	HS7600
		JN3201J	JR3050T	JR3060T	JR3070CT	JS3201J	LS0714	PV7000C	UB1100	UB1101
		UB1102	UT1305	UT1305	UT2204					
CB-325	194074-2	9553NB	9556NBG	9556PBG	9556HBG	9556HP	9557NBG	9563H	GA4040	GD0600
		GD0601	GD0602	HR2230	HR2300	HR2310T	HR2320T	HR2460	HR2470	HR2600
		HR2601	HR2610	HR2611FT	HR2630	HR2631FT	HR2800	HR2810		
CB-411	191940-4	3709	3901	4403	6922NB	9031	9500NB	9523NB	DS4011	JN1601
CB-411A	B-80391	KP0800	RT0700C	TD0101F	TW0200	TW0350				
CB-415	191950-1	6904VH								
CB-415A	B-80400									
CB-419	191962-4	4304	4350CT	9035H	BO4510H	BO4556	BO5031	DA3010F	FS2300	FS2500
CB-419A	B-80422	FS2700	FS4300	HP1620	HP2030	HP2050	HP2070	HR1830	HR2020	HR2440
		JS1300	TD0100	UH4570X	UH5570X	UH6570X	UH7580X			
CB-459	194722-3	GA4030	GA4031	GA4034	GA54530	GA4534	GA5030	GA5034	HR1840	HR1841
		JS1000	JS1601	JS1602	PJ7000	TM3000C	TM3010C			
	3641000	HW111								
	3641160	HW102								
	375009-001	SJ401								
	EIB106C	HB500								
	JM23000123	LH1201FL	LS1018L	MLT100						

Auto Cut - Out Carbon Brush

CB-105	181038-5	HM0810A	HM0810TA	HR2010	HR3520					
CB-105A	B-80307									
CB-155	181048-2	HM1201								
CB-155A	B-80335									
CB-204	191957-7	4112HS	4114S	9617	GA7010C	GA7012C	GA7020	GA7030	GA7040R	GA7040S
CB204A	B-80357	GA9010C	GA9012C	GA9030	GA9030R	GA9040S	GA9050	GS5000	HM1302	HM1305
		HM1306	HM1810	SA7000C						
CB-218	197129-2	GA7060	GA7060R	GA7061R	GA7062	GA7063R	GA9060	HM1812		
CB-318	191978-9	9563C	GA4040C	GA4041C	GD0800C	PK5001C	PO6000C	PW5001C	SG1250	SG1251J
CB-327	195003-8	HM0860C								
CB-350	194160-9	HK1820	HM0870C	HM0871C	HR3200C	HR4001C	HR4002	HR4003C	HR4003C	HR4030C

Carbon Brush for Cordless Tools

CB-430	191971-3	8414D	DCS550	DCO180	BGA450	DGA402	DGA452	DGD800	BHR240	DJN161
CB-438		DJS101	DJS161	DJV180	DPB180	DPJ180	DSS501	BUB360	DUC122	DHR165
		DUB361								
CB-434	193466-2	6932FD	6935FD	BTW121						
CB-440	194427-5	DDA351	DDF442	DDF444	BDF450	BDF452	DDF456	DDF458	DDF482	DFR550
		DFS450	DFS451	BHP442	DHP444	DHP444	BHP450	BHP452	BHP454	DHP456
		DHP458	DHP482	DJS130	BTD142	BTD146	DTP140	DTW152	DTW251	DBN500
		TD091D								
CB-441	194435-6	DHR202	DHR241	DHS630	DJR181	DJR182	DJR186	DKP180	DLS713	DSS610
		DTW450								
CB-442	194928-3	BHR261	BHR262	BUC250	BUH550	BUH650	DHR263	DHS710	DUC252	DUC302
		DUH651								
CB-448	196854-2	DTW152	DTW251							

Strap Belt System

System as a STRAP

Totally new on the market - unique STRAP Belt System with quick release buckles at the ends makes the belt multipurpose. Strap with comfortable soft rubber shoulder pad makes the lifting more comfortable. Fits to all Makita Tool Bags and Cases.



System as a BELT

Strap BELT can be easily detached from any Tool Bag or Tool Case and worn on the waist as a light-duty tool belt. Strap can be adjusted, which is flexible and convenient to fit your need. Can be worn with any Makita Tool Pouch and Holder.



STRAP BELT SYSTEM

Over 45 products within the system

E-05418
Ultimate Adjustable Tool Case

E-05620
Ultimate Lunch Bag & Belt

E-05583
Ultimate Smartphone Holder

E-12980
Ultimate Smartphone Holder XL

E-05212
Ultimate 4-Way Electricians Holder

E-05446
Ultimate Covered Tool Tote

E-05424
Reinforced Adjustable Tool Case

E-05309
Belt Loop - 3 Pack
E-05315
Belt Loop - 6 Pack

E-05278
Tape Measure Holder

E-05262
Knife / Secateur Holder

E-05228
Ultimate 3-Way Hammer & Tool Holder

E-05430
Ultimate Open Tool Tote

E-05474
Ultimate 3-Way Universal Tool Tote

E-05256
Universal Clip Holder

E-05480
Ultimate 4-Sided Tool Tote

E-05234
Side Gate Hammer & Tool Holder

E-05240
Looped Hammer & Axe Holder

E-05599
Thermal Flask & Holder

E-05549
Ultimate Chainsaw Bag

E-05561
Roll-Top All Weather Tube Bag

E-05468
Ultimate Wide Mouth Tool Bag

E-05103
Pencil Driver Holster Universal L/R Handed

E-05608
Thermal Mug & Holder

E-05577
Roll-Top All Weather Duffel Bag

E-05452
Ultimate Gate Mouth Tool Bag

E-05153
Roofer & General Purpose Pouch

E-05147
Ultimate 3 Pocket Fixing Pouch

E-11782
Ultimate Heavyweight Tool Bag

E-12712
Ultimate Heavyweight Tool Bag with Trolley

E-05131
Ultimate 2 Pocket Fixing Pouch

E-05181
Ultimate Electricians Pouch

E-05670
1M Guide Rail Protective Holder

E-05664
1.4M / 1.5M Guide Rail Protective Holder

E-10920
1.9M Guide Rail Protective Holder

E-05094
Drill Holster Universal L/R Handed

E-05125
Universal Pouch & Drill Holster L/R Handed

E-10936
3M Guide Rail Protective Holder

E-05505
Technician Tool & Laptop Bag

E-05496
Semi-Rigid Tool Bag

E-05206
Zip Top Pouch - Dual Battery or Fixings

E-05197
Fixing Pouch & Hammer Holder

E-05119
Impact Driver Holster Universal L/R Handed

E-05284
Ultimate Chisel & Tool Holder

Tool Holders 3rd Generation Technical Solutions



Strap Belt System with quick release buckles at the ends can be easily detached from the Tool Bags and worn on the waist as a light-duty tool belt. Fits all Tool Pouches and Holders as well as Tool Organizers.



3 LAYERS

3L Technology is a unique 3-layer combination of polyesters and foam that provides extra cushioning. Designed to be tough and weatherproof, these amazingly light polypropylene panels are made up of three composite layers joined securely in a desirable configuration. The innovative feature of these structured core panels means that they can be formed into any shape.



WATERPROOF BOTTOM

Waterproof Bottom is a high quality solution for tool bags – rigid, wear-resistant and waterproof it keeps tools dry and protected from damp and wet surfaces. The reinforced plastic base also helps you to keep your tool bag clean.



Real Leather is smooth on the outside with brushed suede on the inside. Strong and tough for a long life but soft and supple enough for lasting comfort, whilst providing excellent strength with added abrasion resistance. Heavy gauge leather has been selected for use in products requiring a thicker covering - 1.8 to 2.0mm - ensuring a top quality product.



Durable Riveting gives truly unbreakable strength. Strong one piece self-punching rivets with washers used in all high stress areas. Washers for greater strength in strategical places are used on one or both sides, up and down.



ANTI SLIP

Anti-Slip Solution minimises or even avoids workplace slip and fall accidents. The high quality polypropylene tape has a rubbery surface which helps to keep you tools in place and provides additional protection to help prolong the life of your products.



Elastic Loops secures the contents and keeps your tools in place while carrying. It provides great flexibility for organizing your tools and accessories. Elastic Loops have been applied to a wide variety of our products to ensure that you get maximum usage from your kit. The loops are able to adapt to perfectly suit all tools and accessories.



Side-Gate Solution lets you easily put the tool in without looking at the holder. An additional swing feature ensures your tool is kept at a comfortable angle. Made of stainless steel for product longevity and fixed by four rivets for extra strength.



Blue Collection

E-05452 - Ultimate Gate Mouth Tool Bag

STRAP/BELT SYSTEM WATERPROOF BOTTOM ELASTIC LOOPS

	metric
height:	280 mm
length:	510 mm
width:	295 mm
weight:	2.18 kg



E-05446 - Ultimate Covered Tool Tote

STRAP/BELT SYSTEM WATERPROOF BOTTOM DURABLE RIVETING ELASTIC LOOPS

	metric
height:	360 mm
length:	490 mm
width:	310 mm
weight:	2.72 kg



E-05430 - Ultimate Open Tool Tote

STRAP/BELT SYSTEM WATERPROOF BOTTOM DURABLE RIVETING ELASTIC LOOPS

	metric
height:	355 mm
length:	490 mm
width:	310 mm
weight:	2.44 kg



E-05511 - Backpack Tool Organiser

WATERPROOF BOTTOM CS BACKPACK CARRYING SYSTEM TOOL LOOPS SYSTEM ELASTIC LOOPS

	metric
height:	490 mm
length:	390 mm
width:	230 mm
weight:	2.56 kg



E-05664 - 1.4M - 1.5M Guide Rail Protective Holder

STRAP/BELT SYSTEM 3 LAYERS

	metric
height:	220 mm
length:	1565 mm
width:	45 mm
weight:	1.45 kg



DESIGNED FOR PROFESSIONAL USE



E-05125 - Universal Pouch & Drill Holster LR Handed

REAL LEATHER 3D SHAPED POUCHES DURABLE RIVETING STRAP/BELT SYSTEM ANTI SLIP 3 LAYERS ELASTIC LOOPS

	metric
height:	270 mm
length:	260 mm
width:	145 mm
weight:	0.55 kg



E-05094 - Drill Holster Universal LR Handed

REAL LEATHER 3D SHAPED POUCHES DURABLE RIVETING STRAP/BELT SYSTEM ANTI SLIP 3 LAYERS ELASTIC LOOPS

	metric
height:	235 mm
length:	155 mm
width:	75 mm
weight:	0.13 kg



E-05197 - Fixing Pouch & Hammer Holder

STRAP/BELT SYSTEM ANTI SLIP 3 LAYERS 3D SHAPED POUCHES REAL LEATHER DURABLE RIVETING ELASTIC LOOPS

	metric
height:	185 mm
length:	180 mm
width:	105 mm
weight:	0.25 kg



E-05147 - Ultimate 3 Pocket Fixing Pouch

STRAP/BELT SYSTEM ANTI SLIP 3 LAYERS 3D SHAPED POUCHES REAL LEATHER DURABLE RIVETING ELASTIC LOOPS

	metric
height:	270 mm
length:	320 mm
width:	145 mm
weight:	0.67 kg



* Tools and accessories not inclusive

Blue Collection



LOOP-CLIP SOLUTION

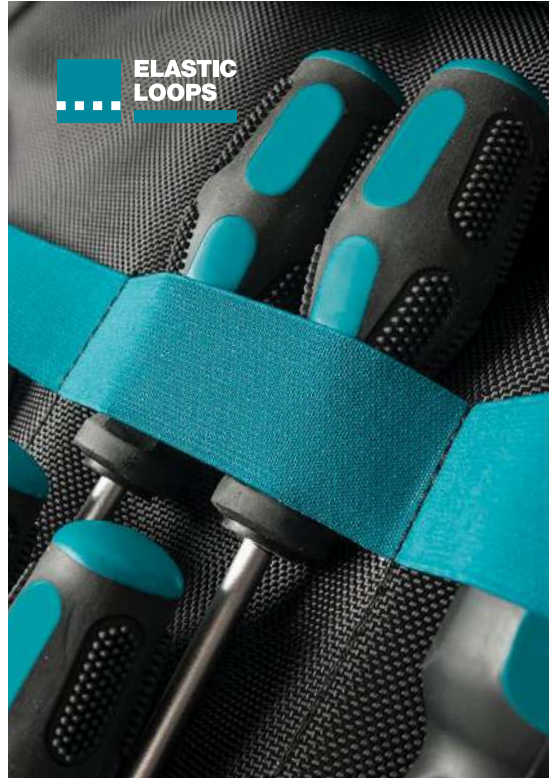

ELASTIC LOOPS



3 LAYERS

3D SHAPED POUCHES

E-05583 - Ultimate Smartphone Holder

STRAP/BELT SYSTEM 3 LAYERS LOOP-CLIP SOLUTION ELASTIC LOOPS

	metric
height:	165 mm
length:	90 mm
width:	40 mm
weight:	0.12 kg



E-12980 - Ultimate Smartphone Holder XL

STRAP/BELT SYSTEM 3 LAYERS LOOP-CLIP SOLUTION ELASTIC LOOPS

	metric
height:	200 mm
length:	115 mm
width:	40 mm
weight:	0.15 kg



E-05658 - Ultimate Knee Pad Set



	metric
height:	240 mm
length:	170 mm
width:	30 mm
weight:	0.28 kg



E-05642 - Knee Pad Set



	metric
height:	240 mm
length:	170 mm
width:	30 mm
weight:	0.28 kg



E-05527 - Bucket Tote Tool Organiser

ELASTIC LOOPS

	metric
height:	320 mm
length:	470 mm
width:	-
weight:	0.68 kg



E-05103 - Pencil Driver Holster Universal LR Handed

STRAP/BELT SYSTEM ANTI SLIP ELASTIC LOOPS

	metric
height:	320 mm
length:	85 mm
width:	60 mm
weight:	0.11 kg



* Tools and accessories not inclusive

Blue Collection

E-05131 - Ultimate 2 Pocket Fixing Pouch



	metric
height:	270 mm
length:	260 mm
width:	145 mm
weight:	0.51 kg



E-05181 - Ultimate Electricians Pouch



	metric
height:	310 mm
length:	250 mm
width:	125 mm
weight:	0.55 kg



E-05212 - Ultimate 4-Way Electricians Holder



	metric
height:	205 mm
length:	185 mm
width:	55 mm
weight:	0.28 kg



E-05153 - Roofer & General Purpose Pouch



	metric
height:	270 mm
length:	290 mm
width:	145 mm
weight:	0.66 kg



E-05393 - Ultimate Padded Braces & Phone Holder



	metric
height:	410 mm
length:	520 mm
width:	23 mm
weight:	0.47 kg



E-05175 - Ultimate Heavyweight Tool Belt Set



	metric
height:	310 mm
length:	880 mm
width:	-
weight:	1.73 kg



E-05343 - Ultimate Leather Belt with Belt Loop



	metric
height:	48 mm
length:	1380 mm
width:	-
weight:	0.30 kg



E-05337 - Quick Release Belt & Belt Loop



	metric
height:	50 mm
length:	1550 mm
width:	-
weight:	0.25 kg



E-05321 - Ultimate Padded Belt with Belt Loop



	metric
height:	100 mm
length:	880 mm
width:	30 mm
weight:	0.66 kg



E-05309 - Belt Loop -3pcs



	metric
height:	129 mm
length:	41 mm
width:	-
weight:	0.03 kg



* Tools and accessories not inclusive

Blue Collection

P-80896 - Smart Phone Holder*

- Universal size fits most most smart phones
- Soft internal lining to protect you phones screen
- Fits any MAKITA Tool Belt

	metric
height:	150 mm
length:	100 mm
width:	25 mm
weight:	0.09 kg



P-80999 - Pencil Driver Holster*

- Designed to hold cordless power tool models
- Hook-and-loop security strap ensures safe climbing ladders and scaffolding

	metric
height:	320 mm
length:	80 mm
width:	50 mm
weight:	0.12 kg



P-71750 - 2 Pocket Fixings Pouch*

- Strong construction with riveted reinforcement
- The pouch sits comfortably on Makita tool belt

	metric
height:	265 mm
length:	260 mm
width:	135 mm
weight:	0.53 kg



TOOLS NEVER FALL OUT



P-71722 - Drill Holster and Pouch*

- Unique design complete interchangeability between left and right users
- Fits cordless or main-powered drill

	metric
height:	280 mm
length:	255 mm
width:	160 mm
weight:	0.58 kg



P-71794 - Drill Holster Universal L/R Handed*

- Designed to hold mains powered or cordless drills.
- Elasticated drill bit loops provide convenient storage

	metric
height:	290 mm
length:	170 mm
width:	85 mm
weight:	0.26 kg



P-71819 - "Super-Heavyweight" Belt*

- The ultimate tool retention system is made from a combination of tough nylon, soft mesh material and riveted reinforcement

	metric
height:	140 mm
length:	865 mm
width:	-
weight:	0.62 kg



P-72095 - Bucket Tote*

- HI-VIS trimming makes the tote eye-catching
- Open design for quick tool location
- Made of soft polyester 600D material

	metric
height:	320 mm
length:	470 mm
width:	-
weight:	0.38 kg



KEEPING YOUR TOOLS WELL PROTECTED

*Limited quantity



* Tools and accessories not inclusive

Combination / Rotary Hammer Drill Capability Chart

		EPTA Weight (kg)																Material for drilling				Working direction	Drilling/chiselling ratio																			
		0	10	20	30	40	50	60	70	80	90	100	110	120	130	140	150	160	Highly reinforced concrete	Concrete, granite, stone, brick	Metal/wood																					
16mm series	HR166D SDS-plus	1.8~2.4	■		■		■		■		■		■		■		■		■		✓	✓✓✓	✓	↕	■																	
																					3.2-16 3.2-10	Diamond core 32 (dry type)																✓	✓✓✓	✓	↕	■
17mm series	DHR171 SDS-plus	2.1~2.8	■		■		■		■		■		■		■		■		■		✓	✓✓✓	✓	↕	■																	
																					3.2-17 3.2-10	Diamond core 32 (dry type)																✓	✓✓✓	✓	↕	■
18mm series	HR1840/41F SDS-plus	2.0~2.5	■		■		■		■		■		■		■		■		■		✓	✓✓✓	✓	↕	■																	
																					3.2-18 3.2-10	Diamond core 32 ~ 65 (dry type)																✓	✓✓✓	✓	↕	■
	DHR182 SDS-plus	2.4~3.2	■		■		■		■		■		■		■		■		■		■		✓	✓✓✓	✓	↕	■															
																				3.2-18 3.2-10	Diamond core 32 (dry type)																✓	✓✓✓	✓	↕	■	
20mm series	DHR202 SDS-plus	3.5	■		■		■		■		■		■		■		■		■		■		✓	✓✓✓	✓	↕	■															
																					3.2-20 4-12	Diamond core 32 (dry type)																✓	✓✓✓	✓	↕	■
22mm series	DHR2230 SDS-plus	2.6	■		■		■		■		■		■		■		■		■		■		✓	✓✓✓	✓	↕	■															
																					3.2-22 4-14	Diamond core 32 ~ 65 (dry type)																✓	✓✓✓	✓	↕	■
	MT870 SDS-plus	2.5	■		■		■		■		■		■		■		■		■		■		✓	✓✓✓	✓	↕	■															
																				3.2-22 4-14	Diamond core 32 ~ 65 (dry type)																✓	✓✓✓	✓	↕	■	
23mm series	HR2300 SDS-plus	2.7	■		■		■		■		■		■		■		■		■		■		✓	✓✓✓	✓	↕	■															
																					3.2-23 4-15	Diamond core 32 ~ 70 (dry type)																✓	✓✓✓	✓	↕	■
	HR2310T SDS-plus	2.9	■		■		■		■		■		■		■		■		■		■		✓	✓✓✓	✓	↕	■															
																					3.2-23 4-15	Diamond core 32 ~ 70 (dry type)																✓	✓✓✓	✓	↕	■
DHR2320T SDS-plus	2.9	■		■		■		■		■		■		■		■		■		■		✓	✓✓✓	✓	↕	■																
																				3.2-23 4-15	Diamond core 32 ~ 70 (dry type)																✓	✓✓✓	✓	↕	■	
24mm series	HR2460 SDS-plus	2.8	■		■		■		■		■		■		■		■		■		■		✓	✓✓✓	✓	↕	■															
																					3.2-24 4-16	Diamond core 32 ~ 65 (dry type)																✓	✓✓✓	✓	↕	■
	HR2470 SDS-plus	2.9	■		■		■		■		■		■		■		■		■		■		✓	✓✓✓	✓	↕	■															
																					3.2-24 4-16	Diamond core 32 ~ 65 (dry type)																✓	✓✓✓	✓	↕	■
	DHR241 SDS-plus	3.5	■		■		■		■		■		■		■		■		■		■		✓	✓✓✓	✓	↕	■															
																				3.2-20 4-12	Diamond core 32 (dry type)																✓	✓✓✓	✓	↕	■	
DHR242 SDS-plus	3.1~3.8	■		■		■		■		■		■		■		■		■		■		✓	✓✓✓	✓	↕	■																
																				3.2-24 4-16	Diamond core 32 ~ 65 (dry type)																✓	✓✓✓	✓	↕	■	
26mm series	DHR263 SDS-plus	3.5	■		■		■		■		■		■		■		■		■		■		✓	✓✓✓	✓	↕	■															
																					3.2-26 4-18	Diamond core 32 ~ 65 (dry type)																✓	✓✓✓	✓	↕	■
	HR2600 Series SDS-plus	2.8~2.9	■		■		■		■		■		■		■		■		■		■		✓	✓✓✓	✓	↕	■															
																					3.2-26 4-18	Diamond core 32 ~ 80 (dry type)																✓	✓✓✓	✓	↕	■
	HR2630 Series SDS-plus	2.8~3.1	■		■		■		■		■		■		■		■		■		■		✓	✓✓✓	✓	↕	■															
																					3.2-26 4-18	Diamond core 32 ~ 80 (dry type)																✓	✓✓✓	✓	↕	■
	HR2650 Series SDS-plus	3.0~3.2	■		■		■		■		■		■		■		■		■		■		✓	✓✓✓	✓	↕	■															
																				3.2-26 4-18	Diamond core 32 ~ 80 (dry type)																✓	✓✓✓	✓	↕	■	
HR2661 SDS-plus	3.2	■		■		■		■		■		■		■		■		■		■		✓	✓✓✓	✓	↕	■																
																				3.2-26 4-18	Diamond core 32 ~ 80 (dry type)																✓	✓✓✓	✓	↕	■	
M8701 SDS-plus	2.7	■		■		■		■		■		■		■		■		■		■		✓	✓✓✓	✓	↕	■																
																				3.2-26 4-18	Diamond core 32 ~ 80 (dry type)																✓	✓✓✓	✓	↕	■	
28mm series	HR2800 Series SDS-plus	3.4~3.6	■		■		■		■		■		■		■		■		■		■		✓	✓✓✓	✓	↕	■															
																					3.2-28 6-20	Diamond core 32 ~ 80 (dry type)																✓	✓✓✓	✓	↕	■
	DHR282 Series SDS-plus	3.9~5.0	■		■		■		■		■		■		■		■		■		■		✓	✓✓✓	✓	↕	■															
																				3.2-28 6-20	Diamond core 32 ~ 65 (dry type)																✓	✓✓✓	✓	↕	■	
HR001G Series SDS-plus	3.9~4.6	■		■		■		■		■		■		■		■		■		■		✓	✓✓✓	✓	↕	■																
																				3.2-28 6-20	Diamond core 32 ~ 65 (dry type)																✓	✓✓✓	✓	↕	■	
30mm series	HR3210FCT Series SDS-plus	4.8~5.4	■		■		■		■		■		■		■		■		■		■		✓✓✓	✓✓✓	✓	↕	■															
																					4-32 10-22	Diamond core 32 ~ 90 (dry type)																✓✓✓	✓✓✓	✓	↕	■
40mm series	HR4002 SDS-max	6.6	■		■		■		■		■		■		■		■		■		■		✓✓✓	✓✓✓	✓	↕	■															
																					10-40 16-32	Diamond core 32 ~ 80 (dry type)																✓✓✓	✓✓✓	✓	↕	■
	HR4013C Series SDS-max	6.2~6.8	■		■		■		■		■		■		■		■		■		■		✓✓✓	✓✓✓	✓	↕	■															
																					10-40 16-35	Diamond core 32 ~ 80 (dry type)																✓✓✓	✓✓✓	✓	↕	■
	DHR400 SDS-max	7.3~8.1	■		■		■		■		■		■		■		■		■		■		✓✓✓	✓✓✓	✓	↕	■															
																				10-40 16-35	Diamond core 32 ~ 80 (dry type)																✓✓✓	✓✓✓	✓	↕	■	
HR005G SDS-max	7.4~7.9	■		■		■		■		■		■		■		■		■		■		✓✓✓	✓✓✓	✓	↕	■																
																				10-40 16-35	Diamond core 32 ~ 80 (dry type)																✓✓✓	✓✓✓	✓	↕	■	
45mm series	HR4511C Series SDS-max	8.2~9.0	■		■		■		■		■		■		■		■		■		■		✓✓✓	✓✓✓	✓	↕	■															
																					10-45 22-40	Diamond core 32 ~ 90 (dry type)																✓✓✓	✓✓✓	✓	↕	■
50mm series	HR5212C Series SDS-max	10.9~11.9	■		■		■		■		■		■		■		■		■		■		✓✓✓	✓✓✓	✓	↕	■															
																					19-52 25-45	Diamond core 32 ~ 90 (dry type)																✓✓✓	✓✓✓	✓	↕	■
	HR006G Series SDS-max	12.9~14.3	■		■		■		■		■		■		■		■		■		■		✓✓✓	✓✓✓	✓	↕	■															
																				19-52 25-45	Diamond core 32 ~ 90 (dry type)																✓✓✓	✓✓✓	✓	↕	■	

approx: 50% drilling, 50% chiselling

- Tungsten Carbide-tipped usable range
- Recommended range
- Core bits

- ✓✓✓ Optimal
- ✓ Possible

Safety Precautions

When using electric tools, basic safety precautions should always be followed to reduce the risk of fire, electric shock, and personal injury, including the following.

/// KEEP WORK AREA CLEAN.

Cluttered areas and benches invite injuries.

/// CONSIDER WORK AREA ENVIRONMENT.

Don't use power tools in damp or wet locations. Keep work area well lit. Don't expose power tools to rain. Don't use power tool in presence of flammable liquids or gases.

/// KEEP CHILDREN AWAY.

All visitors should be kept away from work area. Don't let visitors touch the tool or extension cord.

/// STORE IDLE TOOLS.

When not in use, tools should be stored in a dry, high of locked up place, out of reach of children.

/// DON'T FORCE THE TOOL.

It will do the job better and safer at the rate for which it was intended.

/// USE THE RIGHT TOOL.

Don't force small tools or attachments to do the job of a heavy-duty tool. Don't use tools for purposes not intended.

/// DRESS PROPERLY.

Don't wear loose clothing or jewelry. They can be caught in moving parts. Rubber gloves and non-skid footwear are recommended when working outdoors. Wear protective hair covering to contain long hair.

/// USE SAFETY GLASSES.

Also use face or dust mask if the cutting operation is dusty.

/// DON'T ABUSE THE CORD.

Never carry the tool by the cord or yank it to disconnect it from the socket. Keep the cord away from heat, oil, and sharp edges.

/// SECURE WORK.

Use clamps or a vise to hold the work. It's safer than using your hand and it frees both hands to operate the tool.

/// DON'T OVERREACH.

Keep proper footing and balance at all times.

/// MAINTAIN TOOLS WITH CARE.

Keep cutting tools sharp and clean for better and safer performance. Follow instructions for lubrication and changing accessories. Inspect tool cord periodically and if damaged, have it repaired by an authorized service facility. Inspect extension cords periodically and replace, if damaged. Keep handles dry, clean and free from oil and grease.

/// DISCONNECT TOOLS.

When not in use, before servicing and when changing accessories such as blades, bits and cutters.

/// REMOVE ADJUSTING KEYS AND WRENCHES.

Form the habit of checking to see that keys and adjusting wrenches are removed from the tool before turning it on.

/// AVOID UNINTENTIONAL STARTING.

Don't carry a plugged-in tool with a finger on the switch. Ensure switch is OFF when plugging in.

/// USE OUTDOOR EXTENSION CORDS.

When tool is used outdoors, use only extension cords intended for outdoor use.

/// STAY ALERT.

Watch what you are doing. Use common sense. Don't operate tool when you are tired.

/// CHECK DAMAGED PARTS.

Before further use of the tool, a guard or other part that is damaged should be carefully checked to determine that it will operate properly and perform its intended function. Check for alignment of moving parts, free running of moving parts, breakage of parts, mounting and any other conditions that may affect its operation. A guard or other part that is damaged should be properly repaired or replaced by an authorized service center unless otherwise indicated in this instruction manual. Have defective switches replaced by an authorized service facility. Don't use the tool if the switch does not turn it on and off.

/// GUARD AGAINST ELECTRIC SHOCK.

Avoid body contact with earthed or grounded surfaces (e.g. pipes, radiators, ranges, refrigerators).

/// REPLACEMENT PARTS.

When servicing a tool, use only identical replacement parts.

/// VOLTAGE WARNING:

Before connecting the tool to a power source (receptacle, outlet, etc.) Be sure the voltage supplied is the same as that specified on the nameplate of the tool. A power source with voltage greater than that specified for the tool can result in SERIOUS INJURY to the user V as well as damage to the tool. If in doubt, DO NOT PLUG IN THE TOOL. Using a power source with voltage less than the nameplate rating is harmful to the motor.

Note

- Makita reserves the right to change specifications of parts and accessories without notice.
- Items of standard equipment and specifications may vary by country or area.
- Net weight and dimensions may differ by the type of battery.
- Standard export color for motor housing is Makita industrial green (blue).
- Please state required voltage when ordering. These offers are subject to availability in each country. Actual product color may differ slightly from color reproduced here.
- Weight data in this catalogue is the value measured by us according to EPTA Procedure 01/ 2003.

Warranty

Every **MAKITA** tool is thoroughly inspected and tested before leaving the factory. Subject to the following Terms and Conditions from the date of purchase, this tool is warranty against **defective materials and manufacturing defects for a period of 6 MONTHS for AC and non brushless DC tools, as for brushless DC tools it will be a period of 12 MONTHS.**

The period and conditions of our warranty as follows:

1. Sales receipt must be presented when servicing or warranty is required.
2. Warranty ONLY cover tools distributed by Makita Singapore Pte. Ltd. Warranty does not cover tools purchased overseas or distributed by other countries.
3. **This warranty is valid base on the original purchase receipt with "Date of Purchase", "Model Number" & "Serial Number".**

This warranty will be null & void in any of the following events during the warranty period:

1. The product unit has undergone repair, attempted repair, dismantle or modification in any way whatsoever by any other person.
2. Damage resulting from use of improper accessories, non-genuine replacement parts, disassembly, tampering, alternation and repairing in any way that affects the reliability and performance.
3. Damage resulting from negligence, accident, disaster, improper storage or maintenance, abuse and misuse in evident caused by overloading the tool beyond its capacity.
4. Abnormal voltage or usage of generator, wrong usage not in accordance with the Operation Manual.
5. If the Serial Number on the tool, seal on the battery and charger has been defaced or removed.
6. If any information on the warranty card has been defaced, removed, altered, unreadable or unclear (date of purchase, Serial Number, etc.)

** Makita reserved the rights of amend conditions of warranty without prior notice.
Please visit our website for Makita's Service Centre information

IDEMCO

W : www.idemcosb.com.my
E : idemco@idemcosb.com.my
T : +6 03-7781 7973



www.makita.com.sg

TRADEMARKS



Makita Corporation and its affiliates (collectively referred to as "Makita") are the registered owners of the above trademarks and own the exclusive rights to these trademarks. A party who manufactures, advertises, offers for sale, sells, distributes, imports or exports power tools, batteries and/or related accessories using a trademark which is identical or similar to our trademarks may have infringed our trademarks. Makita take a serious view of trademark infringement and will not hesitate to take any legal action against any party who infringes our trademark rights.

Makita Singapore Pte Ltd

7, Changi South Street 3, Singapore 486348
Phone : +65-6546-8700 Fax : +65-6546-8711
Email : msgproductteam@makita.com.sg
Website : www.makita.com.sg
Facebook : www.facebook.com/MakitaSG



XGT LXT CXT
RoHS REACH

PRINTED IN SINGAPORE