

IDEMCO



www.heyco-qualitaetswerkzeuge.de

Katalog Werkzeuge
Catalogue outils | Catalogus Gereedschappen





HEYTEC



HEYTEC TOOLS aus dem Hause HEYCO

In der über 80-jährigen Unternehmensgeschichte haben wir uns zu einem der führenden Werkzeughersteller entwickelt. Angetrieben von der Leidenschaft, unseren Kunden Produkte anzubieten, die gekennzeichnet sind durch ein Höchstmaß an Qualität und Gebrauchsnutzen. Mit unserer Marke HEYTEC TOOLS sprechen wir den qualitäts- und preisbewussten Handwerker ebenso an wie den anspruchsvollen Heimwerker. Mit einem umfassenden, maßgeschneiderten Werkzeugprogramm, ausgerichtet auf die jeweiligen Bedürfnisse des Anwenders.

HEYTEC TOOLS manufactured by HEYCO

In our company's more than 80-year history, we have developed to become one of the leading tool manufacturers. Driven by the passion for offering our customers products that are distinguished by exceptional quality and usability. Our HEYTEC TOOLS brand addresses both quality and price conscious professional craftsmen and discerning DIY enthusiasts with a comprehensive portfolio of tailor-made tools aligned to the specific needs of their users.



Wir geben immer unser Bestes

Beste Qualität zum besten Preis: Darauf richtet sich unser Blick und dafür steht „HEYTEC TOOLS“. Unsere Kunden verbinden mit dieser Marke Kompetenz, Innovationskraft und Flexibilität. Darauf vertrauen sie und schätzen uns als zuverlässigen Partner. Unser Anspruch ist es, mit ständig neuen Ideen den Anwender für unsere Werkzeuge und Sortimente zu begeistern.

We deliver only the best

We are focused on delivering best quality at the best price – and this is what ‘HEYTEC TOOLS’ stands for. Our customers associate this brand with expertise, innovation and flexibility. They place their trust in it and appreciate us as a reliable partner. We are actively committed to the constant development of new ideas that fire the enthusiasm of users for our tools and our product portfolio.







Wir schaffen Mobilität

Überall dort, wo gearbeitet wird, erweisen sich unsere Werkstattwagen als mobile und praktische Helfer. Kugelgelagerte Räder erleichtern die Beweglichkeit auch bei hoher Belastung. Zwei Lenkrollen mit Bremse und verriegelbaren Schwenklagern verhindern das Wegrollen auch auf schrägen Flächen. Hochbelastbare Schubfächer mit kugelgelagerten Auszugsschienen bieten nicht nur Raum für Werkzeuge und Module, dank großer Staufächer können auch zusätzliche Geräte und Maschinen sicher aufbewahrt werden.

We generate mobility

Our workshop trolleys prove their worth as mobile and practical helpers wherever work is to be done. Their ball bearing mounted wheels make them easy to move, even when heavily loaded. Two castor wheels with brakes and lockable pivot bearings prevent the trolley rolling on both flat and sloping surfaces. Heavy-duty drawers on ball bearing mounted sliding rails offer ample space for tools and modules and, thanks to their large storage compartments, also for the secure stowage of additional equipment and power tools.









Intelligente Fusion

Sortimente sind unsere Stärke. Immer abgestimmt auf die jeweiligen Erfordernisse bieten wir eine Vielzahl an Werkzeug-Zusammenstellungen – übersichtlich angeordnet, leicht entnehmbar und strapazierfähig aufbewahrt.

Intelligent fusion

Tool sets are our strong points. Always aligned to specific needs, the wide range of tool sets we offer are clearly organised, offer easy access to individual tools and are safely stored in hardwearing stowage solutions.

HEYTEC Werkzeugsortimente

in der L-BOXX® von Sortimo

Weitere Informationen

zum Produkt siehe Seite 100-101, 158-161

HEYTEC tool sets

in the L-BOXX® from Sortimo

For further product information

see page 100-101, 158-161





Für jede Anwendung das optimale Werkzeugsortiment

Im robusten Kasten, im stabilen Koffer oder in der pflegeleichten Transporttasche. Mit unseren Sortimenten sind Sie immer optimal ausgestattet.

The right range of tools for every job

In robust boxes, resilient cases or easily cleanable carrying bags. Our tool ranges ensure that you always have exactly the tools you need.









Umfangreiche Taschen-/ Rucksacksortimente

Werkzeugsortiment in Umhängetasche
Montage siehe Seite 103
Elektro siehe Seite 123-125

Werkzeugsortiment im Rucksack
Montage siehe Seite 104-105
Dachdecker/Zimmermann
siehe Seite 104/106
Elektro siehe Seite 121-122

Extensive bag/ backpack assortments

Tool assortment in shoulder bag
Mounting see page 103
Electric see page 123-125

Tool assortment in backpack
Mounting see page 104-105
Roofer/Carpenter see page 104/106
Electric see page 121-122





Wir freuen uns auf gute Zusammenarbeit

Die Kommunikation mit unseren Partnern ist uns immer wichtig. Der Dialog mit unseren Kunden und Anwendern findet auf verschiedenen Wegen statt. Mit unserer Website, auf YouTube, Facebook und Instagram bieten wir fundierte Informationen und Problemlösungen an. Durch unsere kompetente Beratung erreichen wir so ein Höchstmaß an Kundenzufriedenheit.

We look forward to successful collaboration

For us, communication with our partners is always an important factor. The dialogue with our customers and users takes place in a number of different ways. We offer expert information and solutions to your problems on our website, on YouTube and on Facebook and Instagram. Our professional advisory services enable us to achieve an outstanding level of customer satisfaction.

info@heyco.de

www.heyco-qualitaetswerkzeuge.de

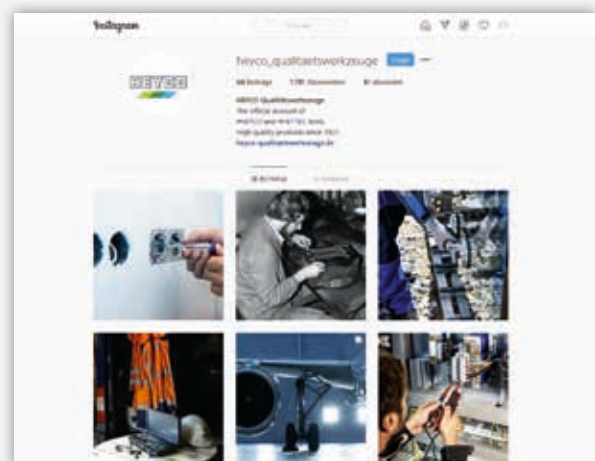

Folgen Sie uns: @heyco_qualitaetswerkzeuge

16 – 28



28 – 76

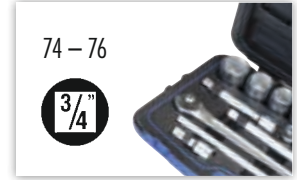
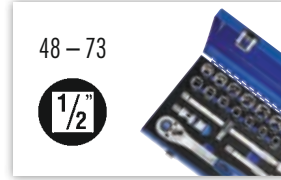

77 – 90

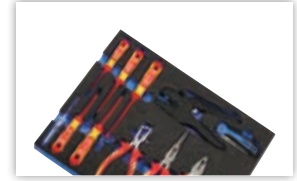
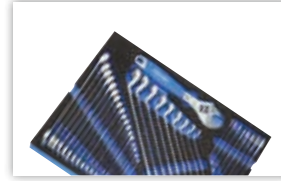
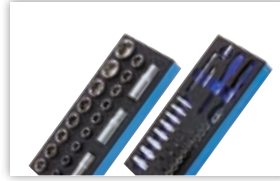

91 – 106

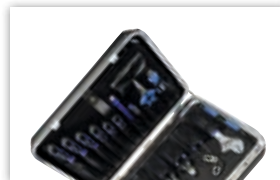

107 – 119

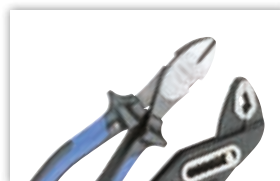

120 – 133

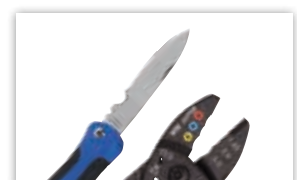

134 – 154

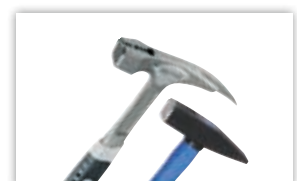
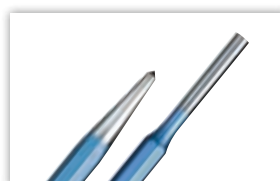

155 – 171



172 – 183



184 – 194

Nummernliste
Inhaltsverzeichnis
Verkaufs-, Lieferungs- und
Zahlungsbedingungen
Abkürzungen, Symbole und Hinweise
Art. No./Seite · Code-No./EAN No.

Liste numérique
Contenu
Conditions de vente,
de livraison et de paiement
Abréviations, symboles et définitions
art.-no./page · Code-No./EAN No.

Nummerlijsten
Inhoud
Verkoop-, leverings- en
betalingsvoorwaarden
Afkortingen, symbolen en aanwijzingen
art.-no./pagina · Code-No./EAN No.

Doppelmaulschlüssel

Chrom-Vanadium, verchromt,
DIN 3110 / ISO 1085

Clés à fourche

Chrome-Vanadium, chromées,
DIN 3110 / ISO 1085

Steeksleutel

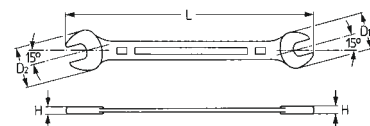
Chroom-Vanadium, verchromd,
DIN 3110 / ISO 1085

Bestell-No./Order-No.	MM	mm	H mm	D1 mm	D2 mm	g	
50800060780	6 x 7	122	3,6	15,7	17,7	18	10
50800080980	8 x 9	140	3,9	20,8	22,9	32	10
50800081080	8 x 10	140	3,9	20,8	22,9	32	10
50800101180	10 x 11	156	4,8	23,9	26,9	54	10
50800101380	10 x 13	172	5,3	28,0	31,0	67	10
50800111380	11 x 13	172	5,5	28,0	29,8	75	10
50800121380	12 x 13	172	5,3	28,0	31,0	61	10
50800131580	13 x 15	190	5,7	32,5	34,9	89	10
50800131780	13 x 17	204	5,9	32,1	38,2	110	10
50800141580	14 x 15	190	5,7	32,5	34,9	90	10
50800161780	16 x 17	204	5,9	36,1	39,2	105	10
50800161880	16 x 18	204	5,9	36,1	39,2	115	10
50800171980	17 x 19	223	6,5	40,2	42,3	155	10
50800181980	18 x 19	223	6,5	40,2	42,3	150	10
50800192280	19 x 22	236	6,8	44,9	48,4	190	10
50800202280	20 x 22	236	6,8	44,9	48,4	185	10
50800212380	21 x 23	250	7,3	47,4	51,5	265	5
50800242780	24 x 27	265	7,8	52,5	58,6	310	5
50800252880	25 x 28	280	8,1	55,2	61,3	350	5
50800273080	27 x 30	280	8,1	58,6	64,4	355	5
50800303280	30 x 32	302	8,6	64,8	70,3	480	5
50800323680	32 x 36	325	8,8	66,5	74,5	550	5
50800364180	36 x 41	358	8,8	74,5	84,0	730	5
50800414680	41 x 46	450	10,4	84,0	92,6	1140	5



K 50800
HP 50800
B 50800
R 50800

Doppelmaulschlüssel-
Sätze

Jeux de clés à fourche

Steeksleutelset

R 50890



HP 50800



K 50800



B 50800

Bestell-No./Order-No.	Art. No.	MM	g	
50800021200	R 50800-212	Werkzeugrolltasche, leer / 12 Fächer/ Tool wallet, empty / 12 compartments	200	5
50800944080	K 50800-8-M	6x7 / 8x9 / 10x11 / 12x13 / 14x15 16x17 / 18x19 / 20x22	695	1
50800947080	K 50800-12-M	6x7 / 8x9 / 10x11 / 12x13 / 14x15 16x17 / 18x19 / 20x22 / 21x23 24x27 / 25x28 / 30x32	2100	1
50800844080	B 50800-8-M	6x7 / 8x9 / 10x11 / 12x13 / 14x15 16x17 / 18x19 / 20x22	710	1
50800644080	HP 50800-8-M	6x7 / 8x9 / 10x11 / 12x13 / 14x15 16x17 / 18x19 / 20x22	790	1
50800747080	R 50800-12-M	6x7 / 8x9 / 10x11 / 12x13 / 14x15 16x17 / 18x19 / 20x22 / 21x23 24x27 / 25x28 / 30x32	2101	1
50890300200	R 50890-12-M	6x7 / 8x9 / 10x11 / 12x13 / 14x15 16x17 / 18x19 / 20x22 / 21x23 / 24x27 240 mm 255 mm / 10"	1990	1



Einmaulschlüssel Technische Details

- Geschmiedeter, gehärteter Schlüsselkörper aus hochwertigem Chrom-Vanadium-Stahl mit geschliffenem Schlüsselkopf, mit Nickel-Chromschicht galvanisiert gegen Korrosion
- Spezialgehärtete, gefräste Greifbacken
- Präzise Führung des gehärteten Schneckenrads
- Gelaserte metrische und Zoll-Skala
- Rutschsicherer Kunststoffgriff
- Amerikanisches Modell mit 22° Maulstellung, rechtsgängig

Adjustable wrenches Technical details

- Chrome-Vanadium steel body, drop forged and hardened, polished head, nickel and chromium plated for protection against corrosion
- Specially hardened and milled jaws
- Precise running of hardened worm-wheel
- Laser-marked scale in metric and inch graduation
- Comfortable non-slip plastic handle
- American pattern with 22° angled head and right hand movement



50839-9004

Mini-Einmaulschlüssel, verstellbar

Chrom-Vanadium, verchromt, mit Kunststoff-Handschutz und Skala

Mini clés à molette

Chrome-Vanadium, chromées, avec poignée souple et graduation

Mini Verstellbare moersleutel, omschakelbaar

Chroom-Vanadium, verchromd, met kunststof handbescherming en schaalverdeling



Bestell-No./Order-No.	Art. No.	mm	CL	"	MM/AF	g	
50839900480	50839-9004	110		4	0 - 15 0 - 5/8"	65	1

50839

Einmaulschlüssel, verstellbar

Chrom-Vanadium, verchromt, mit Kunststoff-Handschutz und Skala

Clés à molette

Chrome-Vanadium, chromées, avec poignée souple et graduation

Verstellbare moersleutel

Chroom-Vanadium, verchromd, met kunststof handbescherming en schaalverdeling



Bestell-No./Order-No.	Art. No.	mm	CL	"	MM/AF	g	
50839000680	50839	160		6	0 - 20 0 - 1/4"	160	5
50839000880	50839	205		8	0 - 25 0 - 1"	310	5
50839001080	50839	255		10	0 - 30 0 - 1.1/4"	540	5
50839001280	50839	305		12	0 - 35 0 - 1.1/2"	800	5

K 50839-3

Sätze mit verstellbaren Einmaulschlüsseln

Jeux de clés à molette

Set met verstellbare moersleutels



Bestell-No./Order-No.	Art. No.		MM/AF	g	
50839000100	K 50839-3	0 - 30	0 - 1.1/4"	1010	1

enthaltend je 1 St.: - composition chaque 1 pce.: - bevat: 50839-6 · 50839-8 · 50839-10

Das HEYTEC-Schonprofil

Schont Schrauben und Müttern. Setzt an den Flächen und nicht an den Kanten an. Eine positive Auswirkung ist die erheblich längere Lebensdauer.

Le profil de protection HEYTEC

Protège boulons et écrous. S'appuie sur les flancs et pas sur les arêtes. Un effet positif sur la durée de vie de la vis et de l'outil.

De HEYTEC profiel beschermer

Beschermt bouten en moeren. Kracht wordt overgebracht op de vlakken, niet op de hoeken. Dit zorgt voor een veel langere levensduur.

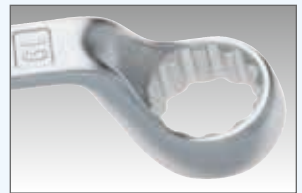
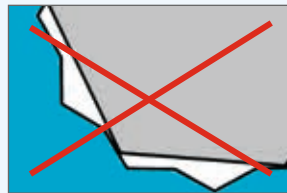

50810



Ringmaulschlüssel

Chrom-Vanadium, verchromt, Schon-Profil
DIN 3113 A / ISO 7738

Clés mixtes

Chrome-Vanadium, chromées, profil de protection SP
DIN 3113 A / ISO 7738

Ringsteeksleutels

Chroom-Vanadium, verchromd, profiel beschermer
DIN 3113 A / ISO 7738

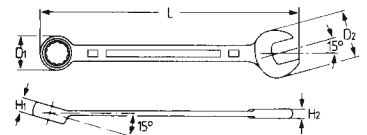

Bestell-No./Order-No.	MM	mm	H1 mm	H2 mm	D1 mm	D2 mm	g	
50810006080	6	100	5,0	3,9	9,8	15,7	12	10
50810007080	7	110	5,5	4,2	11,2	17,0	18	10
50810008080	8	120	5,9	4,4	12,7	19,0	23	10
50810009080	9	130	6,4	4,7	14,1	20,9	33	10
50810010080	10	140	6,9	5,0	15,5	22,8	40	10
50810011080	11	150	7,4	5,2	16,9	25,4	48	10
50810012080	12	160	7,9	5,5	18,3	26,7	58	10
50810013080	13	170	8,4	5,8	19,7	29,3	63	10
50810014080	14	180	8,9	6,1	21,1	31,2	88	10
50810015080	15	190	9,3	6,3	22,6	33,0	97	10
50810016080	16	200	9,8	6,6	24,0	34,5	105	10
50810017080	17	210	10,3	6,9	25,4	37,3	130	10
50810018080	18	220	10,8	7,1	26,8	38,4	145	10
50810019080	19	230	11,1	7,3	28,2	40,4	145	10
50810020080	20	240	11,4	7,5	29,6	42,3	165	10
50810021080	21	250	11,7	7,7	31,0	44,2	190	10
50810022080	22	260	12,0	7,9	32,3	46,6	225	10
50810024080	24	280	12,7	8,3	35,1	50,1	265	5
50810027080	27	310	13,6	8,9	39,2	55,9	330	5
50810030080	30	340	14,6	9,5	43,4	62,6	430	5
50810032080	32	360	15,2	9,9	46,2	66,9	515	5
50810036080	36	400	22,8	14,1	54,6	77,5	1090	5
50810041080	41	450	25,8	15,8	62,1	83,7	1450	3

B 50810
HP 50810
K 50810
R 50810



Ringmaulschlüssel-Sätze

Jeux de clés mixtes

Ring/steeksleutelset

Chrom-Vanadium, verchromt,
 Schon-Profil
 DIN 3113 A / ISO 7738

Chrome-Vanadium, chromées,
 profil de protection SP
 DIN 3113 A / ISO 7738

Chroom-Vanadium, verchromd,
 profiel beschermer
 DIN 3113 A / ISO 7738



B 50810



K 50810



HP 50810-12



R 50810



R 50810-21



Bestell-No./Order-No.	Art. No.	MM		
50810924280	K 50810-8-M	8/9/10/11/13/14/17/19	570	1
50810927180	K 50810-12-M-1	8/9/10/11/12/13/14/15/16/17/18/19	1055	1
50810927280	K 50810-12-M-2	6/7/8/9/10/11/12/13/14/17/19/22	1135	1
50810929080	K 50810-17-M	6/7/8/9/10/11/12/13/14/15/16/17/18/19/20/21/22	1575	1
50810929480	K 50810-21-M	6/7/8/9/10/11/12/13/14/15/16/17/18/19/20/21/22/24/27/30/32	4080	1
50810824280	B 50810-8-M	8/9/10/11/13/14/17/19	590	1
50810827180	B 50810-12-M	8/9/10/11/12/13/14/15/16/17/18/19	980	1
50810724280	R 50810-8-M	8/10/12/13/14/15/17/19	675	1
50810727180	R 50810-12-M-1	8/9/10/11/12/13/14/15/16/17/18/19	1055	1
50810727280	R 50810-12-M-2	6/7/8/9/10/11/12/13/14/17/19/22	1055	1
50810729480	R 50810-21-M	6/7/8/9/10/11/12/13/14/15/16/17/18/19/20/21/22/24/27/30/32	3350	1
50810627380	HP 50810-12-M	8/10/11/12/13/14/15/16/17/18/19/22	1270	1

50805



**Doppelringschlüssel,
tief gekröpft**

Chrom-Vanadium, verchromt,
Schon-Profil
DIN 838 / ISO 1085

**Clés polygonales contre-
coudées profondément**

Chrome-Vanadium, chromées,
profil de protection SP
DIN 838 / ISO 1085

**Ringsleutel,
diep gebogen**

Chroom-Vanadium, verchromd,
profiel beschermer
DIN 838 / ISO 1085

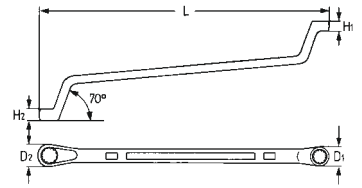

Bestell-No./Order-No.	MM	mm	H1 mm	H2 mm	D1 mm	D2 mm	g	
50805060780	6 x 7	165	5,9	6,5	11,1	12,5	40	10
50805080980	8 x 9	180	6,9	7,4	14,3	15,5	58	10
50805101180	10 x 11	200	7,8	8,3	17,2	18,4	72	10
50805101380	10 x 13	220	7,4	8,7	15,4	19,8	100	10
50805121380	12 x 13	220	8,8	9,3	20,6	21,3	108	10
50805141580	14 x 15	245	9,7	10,2	23,3	24,2	140	10
50805161780	16 x 17	255	10,6	10,9	26,4	27,2	175	5
50805171980	17 x 19	285	12,0	12,0	26,8	28,5	285	5
50805181980	18 x 19	275	11,3	11,6	29,1	30,1	235	5
50805192280	19 x 22	285	11,8	12,3	30,2	31,3	275	5
50805202280	20 x 22	300	12,0	12,7	31,1	34,0	285	5
50805212380	21 x 23	315	12,4	13,1	33,0	36,0	305	5
50805242780	24 x 27	330	13,4	14,5	38,5	41,9	360	5
50805252880	25 x 28	350	13,8	14,9	40,4	43,9	450	5
50805303280	30 x 32	365	15,9	16,5	46,8	49,3	550	5

**K 50805
R 50805
HP 50805**



**Doppelringschlüssel-
Sätze, tief gekröpft**

Chrom-Vanadium, verchromt,
Schon-Profil
DIN 838 / ISO 1085

**Jeux de clés polygonales
contre-coudées
profondément**

Chrome-Vanadium, chromées,
profil de protection SP
DIN 838 / ISO 1085

**Ringsleutelsets,
diep gebogen**

Chroom-Vanadium, verchromd,
profiel beschermer
DIN 838 / ISO 1085



R 50805



K 50805



HP 50805

Bestell-No./Order-No.	Art. No.	MM	g	
50805944080	K-50805-8-M	6x7 / 8x9 / 10x11 / 12x13 / 14x15 / 16x17 / 18x19 / 20x22	1120	1
50805947080	K-50805-12-M	6x7 / 8x9 / 10x11 / 12x13 / 14x15 / 16x17 / 18x19 / 20x22 / 21x23 / 24x27 / 25x28 / 30x32	2950	1
50805747080	R-50805-12-M	6x7 / 8x9 / 10x11 / 12x13 / 14x15 / 16x17 / 18x19 / 20x22 / 21x23 / 24x27 / 25x28 / 30x32	3100	1
50805644080	HP-50805-8-M	6x7 / 8x9 / 10x11 / 12x13 / 14x15 / 16x17 / 18x19 / 20x22	1320	1



Multifunktion 3 in 1

Knarren-Ringmaulschlüssel-Satz:
Maulschlüssel
Ringschlüssel
Knarre

Multifunction 3 in 1

Combination ratchet wrenches set:
Open jaw wrenches
Ring wrenches
Ratchet

Weitere Informationen
zum Produkt siehe Seite 26

For further product information
see page 26



50720



Knarren-Ringmaulschlüssel

Chrom-Vanadium, verchromt, 72 Zähne, Drehmoment Ring nach DIN 899 Reihe A / ISO 1711-1, Maul nach DIN 899 Reihe C / ISO 1711

Clés mixtes à cliquet

Chrome-Vanadium, chromées, 72 dents, couple côté polygonal suivant DIN 899 rang A / ISO 1711-1, fourche suivant DIN 899 rang C / ISO 1711

Ringratel-steeksleutels

Chroom-Vanadium, verchromd, 72 tanden, draaimoment-ring volgens DIN 899 rij A / ISO 1711-1, bek volgens DIN 899 rij C / ISO 1711

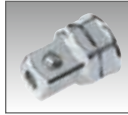
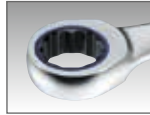

1/4 Adapter, siehe Seite 27
3/8 Adaptateurs, voir page 27
1/2 Adapter, zie pagina 27

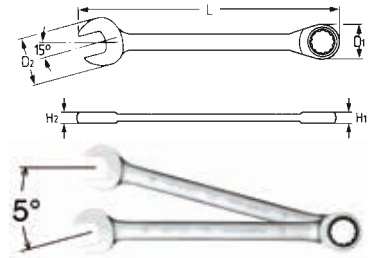

Bestell-No./Order-No.	MM	mm	H1 mm	H2 mm	D1 mm	D2 mm	g	
5072008080	8	140,0	6,6	4,6	17,0	16,8	32	10
5072009080	9	150,0	7,0	5,0	19,5	18,5	40	10
50720010080	10	160,0	7,5	5,3	20,5	20,8	59	10
50720011080	11	165,0	8,0	6,0	22,2	23,0	70	10
50720012080	12	172,0	8,3	6,3	23,0	25,3	77	10
50720013080	13	178,0	8,7	6,6	25,3	27,2	85	10
50720014080	14	190,0	9,0	6,8	28,2	29,2	105	10
50720015080	15	200,0	9,5	7,0	29,2	31,5	125	10
50720016080	16	207,0	10,0	7,5	30,0	32,8	225	10
50720017080	17	225,0	10,3	7,7	31,7	35,0	160	10
50720018080	18	240,0	11,5	8,3	32,2	37,5	200	10
50720019080	19	248,0	10,3	8,7	34,3	39,5	210	10
50720022080	22	278,0	10,3	9,0	42,0	45,0	381	10
50720024080	24	300,8	13,4	9,9	46,7	51,5	500	5
50720027080	27	304,1	14,9	10,9	48,7	55,9	601	5

K 50720
R 50720
M 50720



Knarren-Ringmaulschlüssel-Sätze

Jeux de clés mixtes à cliquet

Ringratel-steeksleutelset



R 50720



M 50720



K 50720

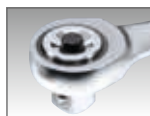

1/4 Adapter, siehe Seite 27
3/8 Adaptateurs, voir page 27
1/2 Adapter, zie pagina 27

Bestell-No./Order-No.	Art. No.	MM	g	
50720600080	K 50720-6-M	8/10/12/13/17/19	623	1
50720600180	R 50720-6-M	8/10/12/13/17/19	755	1
50720600380	R 50720-8-M	8/10/12/13/14/15/17/19	1005	1
50720600280	M 50720-10-M	8/10/12/13/14/15/16/17/18/19	1400	1

50725

**Knarren-Ringmaul-
schlüssel, umschaltbar**

Chrom-Vanadium, verchromt,
72 Zähne, Drehmoment Ring
nach DIN 899 Reihe A / ISO
1711-1, Maul nach DIN 899
Reihe C / ISO 1711

**Clés mixtes à cliquet
réversible**

Chrome-Vanadium, chromées,
72 dents, couple côté polygonal
suivant DIN 899 rang A / ISO
1711-1, fourche suivant DIN 899
rang C / ISO 1711

**Omschakelbare ringratel-
steeksleutel**

Chroom-Vanadium, verchromd,
72 tanden, draaimoment-ring
volgens DIN 899 rij A / ISO 1711-
1, bek volgens
DIN 899 rij C / ISO 1711



1/4 Adapter, siehe Seite 27
3/8 Adaptateurs, voir page 27
1/2 Adapter, zie pagina 27

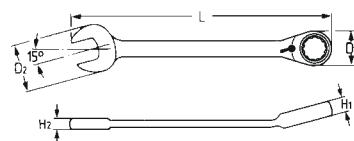

Bestell-No./Order-No.	MM	mm	H1 mm	H2 mm	D1 mm	D2 mm	g	
50725008080	8	140,0	8,2	5,3	17,0	17,0	37	10
50725009080	9	150,0	8,2	5,5	19,0	18,8	47	10
50725010080	10	160,0	8,4	6,0	20,5	21,7	62	10
50725011080	11	165,0	9,4	6,4	21,5	23,0	71	10
50725012080	12	170,0	9,4	6,5	22,5	25,2	84	10
50725013080	13	178,0	9,4	7,3	24,0	26,5	95	10
50725014080	14	190,0	9,4	7,5	26,5	29,6	112	10
50725015080	15	200,0	9,4	7,8	28,0	31,3	142	10
50725016080	16	210,0	11,1	8,1	29,0	33,4	155	10
50725017080	17	225,0	11,1	8,4	30,5	36,3	175	10
50725018080	18	237,0	12,4	9,1	31,5	38,0	210	10
50725019080	19	248,0	12,4	9,3	33,0	39,0	235	10
50725022080	22	290,0	13,0	9,3	39,0	46,0	380	10
50725024080	24	335,0	14,5	10,4	45,5	52,3	530	5
50725027080	27	353,0	14,8	11,6	51,8	58,5	624	5
50725030080	30	419,0	16,8	12,2	59,3	64,5	939	5
50725032080	32	420,0	16,9	12,2	59,5	64,6	942	5

**K 50725
R 50725
M 50725**

**Knarren-Ringmaul-
schlüssel-Sätze,
umschaltbar**
**Jeux de clés mixtes à
cliquet réversible**
**Omschakelbare ringratel-
steeksleutelset**

R 50725-8
M 50725
K 50725

1/4 Adapter, siehe Seite 27
3/8 Adaptateurs, voir page 27
1/2 Adapter, zie pagina 27

Bestell-No./Order-No.	Art. No.	MM	g	
50725600080	K 50725-6-M	8/10/12/13/17/19	690	1
50725600180	R 50725-6-M	8/10/12/13/17/19	825	1
50725600380	R 50725-8-M	8/10/12/13/14/15/17/19	974	1
50725600280	M 50725-10-M	8/10/11/12/13/14/16/17/18/19	1550	1

50725-6005



Knarren-Ringmaulschlüssel-Satz, 10-tlg.

Multifunktion 3 in 1
Maulschlüssel
Ringschlüssel
Knarre

Knarren-Ringmaulschlüssel aus Chrom-Vanadium Stahl, verchromt, mit Hebelumschaltung, 72 Zähne, Drehmoment Ring nach DIN 899 Reihe A / ISO 1711-1, Maul nach DIN 899 Reihe C / ISO 1711

Jeu de clés mixtes à cliquet, 10 pces.

Multifonction 3 en 1
Clé à molette
Clé polygonale
Cliquet

Clés mixtes à cliquet de Chrome-Vanadium, chromées, 72 dents, couple côté polygonal suivant DIN 899 rang A / ISO 1711-1, fourche suivant DIN 899 rang C / ISO 1711

Omschakelbare ringratelsteeksleutelset, 10-dlg

Multifunctie 3-in-1
Steeksleutel
Ringsleutel
Ratel

Ratelringsleutel uit Chroom-Vanadium staal, verchromd, met omschakelpal, 72 tanden, draaimomentring volgens DIN 899 rij A / ISO 1711-1, bek volgens DIN 899 rij C / ISO 1711



enthaltend/containing/composition	
	MM 8/10/11/13/14/17/19
	1/4" / 3/8" / 1/2"

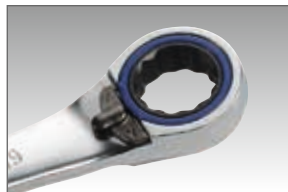

Bestell-No./Order-No.	Art. No.	Maße · Dimensions		
50725600580	50725-6005	250 x 140 x 40	1600	1

50730



4 in 1 Knarren-Ringschlüssel

Chrom-Vanadium, verchromt, mit Hebelumschaltung, 72 Zähne

4 en 1 clé polygonale à cliquet

Chrome-Vanadium, chromées, avec cliquet réversible, 72 dents

4 in 1 ringratelsteeksleutel

Chroom-Vanadium, verchromd, met omschakelpal, 72 tanden



Bestell-No./Order-No.	Art. No.	mm	MM		
50730081383	50730	165	8 x 10 x 12 x 13	105	5
50730091583	50730	180	9 x 11 x 14 x 15	150	5
50730101983	50730	251	10 x 13 x 17 x 19	273	5
50730161983	50730	225	16 x 17 x 18 x 19	255	5
50730202483	50730	255	20 x 21 x 22 x 24	480	5

R 50730-3



4 in 1 Knarren-Ringschlüssel-Satz

In stabiler Textil-Gürteltasche mit Klettverschluss, 3-tlg.

Jeux de clés polygonale à cliquet 4 en 1

En etui de ceinture résistant avec fermeture velcro, 3 pcs.

4 in 1 ringratel-steeksleutelset

In stevige nylon tas met klittebandsluiting, 3 delig



Bestell-No./Order-No.	Art. No.	MM	g	
50730600183	R 50730-3	8 x 10 x 12 x 13 9 x 11 x 14 x 15 16 x 17 x 18 x 19	495	1

50825-12 50840-12 50850-12

1/4"

3/8"

1/2"

Adapter für Knarren-Ringmaulschlüssel

Adaptateur pour clés mixtes à cliquet

Adapter voor ringratel-steeksleutel

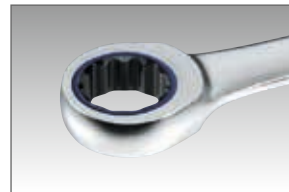

Bestell-No./Order-No.	Art. No.	■	für · pour · voor HEYTEC No.	MM	g	
50825121083	50825-1210	1/4"	50720	10	6	10
50840121383	50840-1213	3/8"	+	13	18	10
50850121983	50850-1219	1/2"	50725	19	50	10

50740



Gerüstbauknarre

Chrom-Vanadium, verchromt
Diese Gerüstbauknarre ist ein extrem stabiles Modell, mit umschaltbarer Knarre und einem Durchlass für den Gewindebolzen. Das Ende des Handgriffs ist als Dorn ausgeführt und ermöglicht somit ein schnelles justieren der Bauteile. Passende Gürteltasche siehe Seite 181.

Outils pour monteurs d'échafaudages

Chrome-Vanadium, chromées
L'outil idéal pour les pros du Bâtiment. L'outil dispose d'un modèle extrêmement robuste avec cliquet réversible et un passage pour les tiges filetées. L'extrémité de la poignée est conçue en forme de mandrin et permet ainsi un ajustement rapide des éléments à assembler. Sac de ceinture voir page 181.

Werfpunratel

Chroom-Vanadium, verchromd
Deze werfpunratel is extreem robuust, met omschakelbare ratel, geschikt voor verzonken bouten.
Uitgevoerd met centreerpunt voor het snel justeren van boutgaten. Bijpassende riemtas zie pagina 157.



Bestell-No./Order-No.	Art. No.	mm	MM	g	
50740192236	50740	315	19 x 22	150	2

50742



Gerüstbauknarre mit Nagelzieher

Chrom-Vanadium, verchromt
Diese Gerüstbauknarre ist ein extrem stabiles Modell, mit Umschaltknarre und einem Durchlass für den Gewindebolzen. Mit integriertem ausklappbarem Nagelzieher. Das Ende des Handgriffs ist als Dorn ausgeführt und ermöglicht somit ein schnelles justieren der Bauteile. Passende Gürteltasche siehe Seite 181.

Echafaudage à cliquet avec arrache-clous

Chrome-Vanadium, chromées
Ce cliquet d'échafaudage est un modèle extrêmement stable avec cliquet réversible et un passage pour la tige filetée. Avec arrache clous pliable intégré. L'extrémité de la poignée est conçue en forme de mandrin et permet ainsi un réglage rapide des composants. Sac de ceinture voir page 181.

Werfpuntratel met spijkertrekker

Chroom-Vanadium, verchromd.
Deze werfpuntratel is een extreem robuust model, met omschakelbare ratel en een doorlaat voor moerbouten. Met geïntegreerde, uitklapbare spijkertrekker. Het einde van de greep is als doorn uitgevoerd en maakt snel uitlijnen van bouwdeelen mogelijk. Bijpassende riemtas zie pagina 181.



Bestell-No./Order-No.	Art. No.	CL mm	MM	g	
50742192280	50742	315	19 x 22	1400	2



50825-00-15

Antriebssteile

Chrom-Vanadium, verchromt

Accessoires

Chrome-Vanadium, chromées

Ratels

Chroom-Vanadium, verchromd

Hebelumschaltknarre

Mit Auswerferstift zum Schnelllösen der Steckverbindung, 48 Zähne

Mit ergonomischem 2-K Griff DIN 3122 D · ISO 3315

Cliquets réversibles

Tige d'éjection pour libérer rapidement l'outil du cliquet, 48 dents

Avec poignée ergonomique à 2 composantes DIN 3122 D · ISO 3315

Omschakelbare ratel

Met ontgrendelstift, 48 tanden

Met ergonomische 2 componenten greep DIN 3122 D · ISO 3315



Bestell-No./Order-No.	Art. No.	□ ■	CL mm	g	
50825015083	50825-00-15	1/4"	150	135	5

50825-00-17

Hebelumschaltknarre

Mit Auswerferstift zum Schnelllösen der Steckverbindung, 48 Zähne

Arretierbar mit ergonomischem 2-K Griff und Gürtelclip

Cliquets réversibles

Tige d'éjection pour libérer rapidement l'outil du cliquet, 48 dents

Locable avec poignée ergonomique à 2 composantes et adaptateur de ceinture

Omschakelbare ratel

Met ontgrendelstift, 48 tanden

Knikbaar, met ergonomische 2 componenten greep en riemclip



Bestell-No./Order-No.	Art. No.	□ ■	CL mm	g	
50825017083	50825-00-17	1/4"	140	146	5



Die neue Knarren-Generation

- 30% mehr Drehmoment
- 30% mehr Leistung
- 30% mehr Freiraum
- 100% Qualität

The new ratchet generation

- 30% higher torque
- 30% higher performance
- 30% more free space
- 100% Quality



50825-00-18

Antriebssteile Chrom-Vanadium, verchromt	Accessoires Chrome-Vanadium, chromées	Ratels Chroom-Vanadium, verchroomd
T-Griff mit Ratschenfunktion Mit Auswerferstift zum Schnelllösen der Steckverbindung, 48 Zähne Arretierbar, aus Zink-Druckguß in schwerer Ausführung, mit Schnelllösemechanik und rechts/links-Umschaltung	T-poignée cliquet Tige d'éjection pour libérer rapidement l'outil du cliquet, 48 dents Execution zingué avec mécanisme de déconnexion rapide, fonction d'arrêt et fonction de modification droite-gauche	T-greep met ratelfunctie Met ontgrendelstift, 48 tanden Knikbaar, uit spuitgietzink, zware uitvoering, met snelwissel mechanisme en rechts/links omschakeling



Bestell-No./Order-No.	Art. No.		\varnothing mm		
50825018083	50825-00-18	1/4"	115	146	5

50825-10-15

Hebelumschaltknarre Mit Auswerferstift zum Schnelllösen der Steckverbindung, 48 Zähne Gebogener Stahlkern, kunststoffummantelt DIN 3122 D · ISO 3315	Cliquets réversibles Tige d'éjection pour libérer rapidement l'outil du cliquet, 48 dents Poignée en acier déporté, à enrobage plastique DIN 3122 D · ISO 3315	Omschakelbare ratel Met ontgrendelstift, 48 tanden Gebogen stalen kern, kunststof mantel DIN 3122 D · ISO 3315
--	--	--



Bestell-No./Order-No.	Art. No.		\varnothing mm		
50825101500	50825-10-15	1/4"	148	97	5

50825-10-16

Hebelumschaltknarre Mit Auswerferstift zum Schnelllösen der Steckverbindung Gebogener Stahlkern, 72 Zähne	Cliquets réversibles Tige d'éjection pour libérer rapidement l'outil du cliquet, 72 dents Poignée en acier déporté, 72 dents	Omschakelbare ratel Met ontgrendelstift Gebogen stalen kern, 72 tanden
--	---	---



Bestell-No./Order-No.	Art. No.		\varnothing mm		
50825101680	50825-10-16	1/4"	150	250	5



50825-10-17

Antriebsteile	Accessoires	Ratels
Chrom-Vanadium, verchromt	Chrome-Vanadium, chromées	Chroom-Vanadium, verchroomd
Hebelumschaltknarre	Cliquets réversibles	Omschakelbare ratel
Mit Auswerferstift zum Schnelllösen der Steckverbindung, 60 Zähne	Tige d'éjection pour libérer rapidement l'outil du cliquet, 60 dents	Met ontgrendelstift, 60 tanden
Mit ergonomischem 2-K Griff	Avec poignée ergonomique à 2 composantes	Met ergonomische 2 componenten greep
Extrem schlank, bestens geeignet für enge Bauräume	Extremement mince, parfaitement adaptée aux petits espaces	Extrem slanke uitvoering, uitermate geschikt voor krappe werkrumtes
30% mehr Drehmoment durch innovative Sperrfunktion	30% plus de couple grâce à la fonction de barrière innovante	30% meer draaimoment door innovatieve blokkeerfunctie

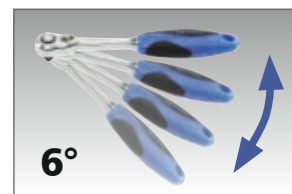
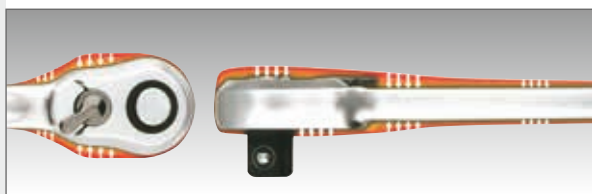

Bestell-No./Order-No.	Art. No.		mm		
50825101783	50825-10-17	1/4"	150	150	5

50825-11-15

Antriebsteile	Accessoires	Ratels
Chrom-Vanadium, verchromt	Chrome-Vanadium, chromées	Chroom-Vanadium, verchroomd
Hebelumschaltknarre	Cliquets réversibles	Omschakelbare ratel
Mit Auswerferstift zum Schnelllösen der Steckverbindung, 48 Zähne	Tige d'éjection pour libérer rapidement l'outil du cliquet, 48 dents	Met ontgrendelstift, 48 tanden
Mit ergonomischem 2-K Griff, ideal für schwer zugängliche Stellen	Avec poignée ergonomique à 2 composantes, idéal pour les endroits difficiles d'accès	Met ergonomische 2 componenten greep, ideaal voor moeilijk bereikbare plaatsen



Bestell-No./Order-No.	Art. No.		mm		
50825111583	50825-11-15	1/4"	115	94	5

50833-3-1

Antriebsteile	Accessoires	Ratels
Chrom-Vanadium, verchromt	Chrome-Vanadium, chromées	Chroom-Vanadium, verchroomd
Mini-Bit-Knarre	Cliquet à embouts mini	Mini ratelbithouder
Mit Auswerferstift zum Schnelllösen der Steckverbindung, 48 Zähne	Tige d'éjection pour libérer rapidement l'outil du cliquet, 48 dents	Tige d'éjection pour libérer rapidement l'outil du cliquet, 48 dents
Mini-Bit-Knarre, 48 Zähne, blau eloxiert, rechts/links-Umschaltung, zur Aufnahme von Bits	Cliquet à embouts mini, 48 dents, bleu anodisé, gauche/droite, pour enlèvement direct d'embouts	48 tands, blauw geëloxeerd, rechts/links omschakelbaar met bitopname



Bestell-No./Order-No.	Art. No.		mm		
50833300100	50833-3-1	1/4"	85	46	5



Verbindungssteile	Accessoires	Hulpstukken
Chrom-Vanadium, verchromt	Chrome-Vanadium, chromées	Chroom-Vanadium, verchromd

50825-03

Griff mit Gleitstück
DIN 3123 B · ISO 3316

Poignée coulissante
DIN 3123 B · ISO 3316

Greep met schuifstuk
DIN 3123 B · ISO 3316



Bestell-No./Order-No.	Art. No.		\varnothing mm		
50825030083	50825-03	1/4"	115	42	10

50825-04/05/05-5

Verlängerungen
DIN 3123 B · ISO 3316

Rallonges
DIN 3123 B · ISO 3316

Verlengstukken
DIN 3123 B · ISO 3316



Bestell-No./Order-No.	Art. No.		\varnothing mm		
50825040083	50825-04	1/4"	50	35	10
50825050083	50825-05	1/4"	100	44	10
50825055083	50825-05-5	1/4"	102	43	5

50825-05-6/-7

Verlängerungen mit Zugbetätigung
Zum Schnelllösen und zur Arretierung der Steckverbindung

Rallonges
Avec déconnexion rapide automatique pour blocage du connecteur

Verlengstukken
Met snelwissel mechanisme



Bestell-No./Order-No.	Art. No.		\varnothing mm		
50825056083	50825-05-6	1/4"	100	49	10
50825057083	50825-05-7	1/4"	250	109	5

50825-08

Steckgriff
DIN 3122 E · ISO 3315

Rallonges emmanchée
DIN 3122 E · ISO 3315

Schroevendraaiergreep
DIN 3122 E · ISO 3315



Bestell-No./Order-No.	Art. No.		\varnothing mm		
50825080083	50825-08	1/4"	150	98	10



50825-06

Verbindungsteile Chrom-Vanadium, verchromt	Accessoires Chrome-Vanadium, chromées	Hulpstukken Chroom-Vanadium, verchromd
---	--	---

Kardangelen DIN 3123 C · ISO 3316	Cardan universel DIN 3123 C · ISO 3316	Kardangewricht DIN 3123 C · ISO 3316
--------------------------------------	---	---



Bestell-No./Order-No.	Art. No.		\varnothing mm		
50825060083	50825-06	1/4"	37	26	10

Einsätze mit Schon-Profil und Kreuzrändelung

Super-Oberflächen-Verarbeitung, Oberfläche in Matt-Finish. Mehr Grip durch Kreuzrändelung. Schon-Profil schützt Schrauben und Muttern.

Douilles avec profil de protection et moletage en croix

Parfaite finition des surfaces, surfaces en finition mat, meilleur contact grâce au moletage en croix, le profil spécial protège les boulons et écrous.

Dopsleutels met profiel bescherming

Superieure oppervlak behandeling, oppervlak in matte finish meer grip door geribbeld profiel. Profiel bescherming beschermt bouten en moeren.

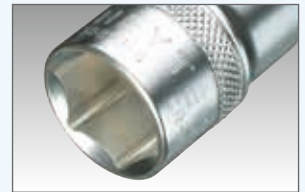

50825-6



Steckschlüsseinsätze, sechskant DIN 3124 / ISO 2725 Chrom-Vanadium, verchromt	Douilles, 6 pans DIN 3124 / ISO 2725 Chrome-Vanadium, chromées	Dopsleutels, zeskant DIN 3124 / ISO 2725 Chroom-Vanadium, verchromd
---	--	---

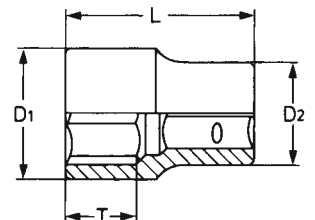

Bestell-No./Order-No.	\varnothing MM	\varnothing mm	T mm	D1 mm	D2 mm		
50825600483	4	25,0	9,0	7,0	12,0	9	10
50825604583	4,5	25,0	9,0	7,0	12,0	10	10
50825600583	5	25,0	9,0	8,0	12,0	10	10
50825605583	5,5	25,0	9,0	9,0	12,0	9	10
50825600683	6	25,0	9,0	9,0	12,0	10	10
50825600783	7	25,0	9,0	10,0	12,0	11	10
50825600883	8	25,0	9,0	12,0	12,0	12	10
50825600983	9	25,0	11,0	13,0	13,0	14	10
50825601083	10	25,0	11,0	14,0	14,0	15	10
50825601183	11	25,0	12,0	16,0	16,0	21	10
50825601283	12	25,0	13,0	17,0	17,0	24	10
50825601383	13	25,0	13,0	18,0	18,0	27	10
50825601483	14	25,0	14,0	19,5	19,5	34	10
50825601583	15	25,0	15,0	21,5	21,5	52	10

50825-19



Steckschlüsseinsätze, extra lang

DIN 3124 / ISO 2725
Chrom-Vanadium, verchromt

Douilles, extra longues

DIN 3124 / ISO 2725
Chrome-Vanadium, chromées

Dopsleutels, verlengd

DIN 3124 / ISO 2725
Chroom-Vanadium, verchromd

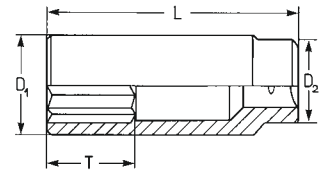

Bestell-No./Order-No.	ØMM	CL mm	T mm	D1 mm	D2 mm	g	mm
50825190683	6	50,0	12,0	10,0	12,0	22	10
50825190783	7	50,0	19,0	10,5	12,0	23	10
50825190883	8	50,0	19,0	12,0	12,0	25	10
50825190983	9	50,0	19,0	13,0	12,0	29	10
50825191083	10	50,0	21,0	14,5	13,0	35	10
50825191183	11	50,0	23,0	16,0	14,0	42	10
50825191283	12	50,0	23,0	17,0	15,0	45	10
50825191383	13	50,0	23,0	18,0	16,0	52	10
50825191483	14	50,0	23,0	19,0	17,0	55	10

50825-20



Steckschlüsseinsätze für Außen-TORX®- Schrauben

Chrom-Vanadium, verchromt

Douilles pour vis TORX® extérieures

Chrome-Vanadium, chromées

Dopsleutels voor TORX® bouten

Chroom-Vanadium, verchromd

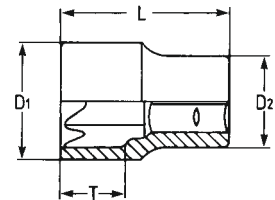

Bestell-No./Order-No.	E	mm	CL mm	T mm	D1 mm	D2 mm	g	mm
50825200483	4	3,86	25,0	7,0	7,0	12,0	10	10
50825200583	5	4,75	25,0	7,0	8,0	12,0	10	10
50825200683	6	5,74	25,0	7,0	9,0	12,0	11	10
50825200783	7	6,22	25,0	12,0	11,0	12,0	12	10
50825200883	8	7,52	25,0	12,0	12,0	12,0	13	10
50825201083	10	9,42	25,0	12,0	14,0	14,0	15	10
50825201183	11	10,08	25,0	12,0	16,0	16,0	19	10

50825-70 98718-25



Leiste für Steckschlüssel- einsätze

Zur Aufnahme von zehn 1/4" Steckschlüsseinsätzen. Die Einsätze und die Leiste werden mit Hilfe von Magnetleisten gehalten.

Bornes pour douilles

Blocage des bornes dues aux aimantes et les surfaces métalliques.

Strip voor dopsleutels

Voor 10 dopsleutels 1/4". De dopsleutels worden door magneten op hun plek gehouden.

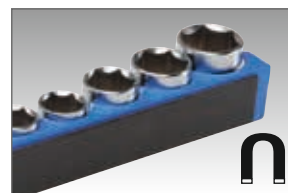

Bestell-No./Order-No.	Art. No.	ØMM	CL mm	g	mm
50825700083	50825-70	4/5/6/7/8/9/10/11/12/13	170	300	1
98718250000	98718-25	leer/empty	170	190	1

**50825-30 –
50825-37**

 Schraubendreher-
Einsätze

Chrom-Vanadium, verchromt

Douilles tournevis

Chrome-Vanadium, chromées

 Schroevendraaier
dopsleutels

Chrom-Vanadium, verchromd



50825-30



50825-31



50825-32



50825-33



XZN

50825-35

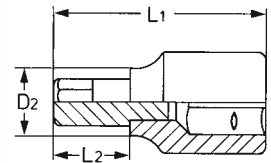

50825-37

50825-30

Bestell-No./Order-No.	Art. No.			L1 mm	L2 mm	D2 mm		
50825300383	50825-30	4,0	0,7	36,0	18,0	12,0	15	10
50825300483	50825-30	5,5	0,9	36,0	18,0	12,0	15	10
50825300583	50825-30	7,0	1,0	36,0	18,0	12,0	15	10

50825-31

Bestell-No./Order-No.	Art. No.		MM	L1 mm	L2 mm	D2 mm		
50825310183	50825-31	3	3	36,0	17,0	12,0	15	10
50825310283	50825-31	4	4	36,0	17,0	12,0	15	10
50825310383	50825-31	5	5	36,0	17,0	12,0	15	10
50825310483	50825-31	6	6	36,0	17,0	12,0	15	10

50825-32

Bestell-No./Order-No.	Art. No.		L1 mm	L2 mm	D2 mm		
50825320183	50825-32	PH 1	36,0	17,0	12,0	15	10
50825320283	50825-32	PH 2	36,0	17,0	12,0	15	10
50825320383	50825-32	PH 3	36,0	17,0	12,0	15	10

50825-33

Bestell-No./Order-No.	Art. No.		L1 mm	L2 mm	D2 mm		
50825330183	50825-33	M5	36,0	17,0	12,0	15	10
50825330283	50825-33	M6	36,0	17,0	12,0	15	10
50825330383	50825-33	M8	36,0	17,0	12,0	15	10

50825-35

Bestell-No./Order-No.	Art. No.		L1 mm	L2 mm	D2 mm		
50825350183	50825-35	PZ 1	36,0	17,0	12,0	15	10
50825350283	50825-35	PZ 2	36,0	17,0	12,0	15	10
50825350383	50825-35	PZ 3	36,0	17,0	12,0	15	10

50825-37

Bestell-No./Order-No.	Art. No.			L1 mm	L2 mm	D2 mm		
50825370883	50825-37	TT 8	2,52	37,0	17,0	12,0	15	10
50825371083	50825-37	TT 10	2,68	37,0	17,0	12,0	15	10
50825371583	50825-37	TT 15	3,48	37,0	17,0	12,0	15	10
50825372083	50825-37	TT 20	3,75	37,0	17,0	12,0	15	10
50825372583	50825-37	TT 25	4,25	37,0	17,0	12,0	15	10
50825372783	50825-37	TT 27	5,00	37,0	17,0	12,0	15	10
50825373083	50825-37	TT 30	5,55	37,0	17,0	12,0	15	10
50825374083	50825-37	TT 40	6,50	37,0	17,0	12,0	15	10

Verbindungssteile	Accessoires	Hulpstukken
Chrom-Vanadium, verchromt	Chrome-Vanadium, chromées	Chroom-Vanadium, verchromd

50800-3306



Adapter für 1/4" Bits
Innensechskant, mit Halteklammer

Adaptateur pour embouts de 1/4"
6-pans femelle, avec clavette de blocage

Adapter voor 1/4" bits
Met binnenzeskant, met klem



Bestell-No./Order-No.	Art. No.		mm		
50800330683	50800-3306	1/4"	25	20	10

50825-1501



Adapter
DIN 3123 A · ISO 3316

Réducteur
DIN 3123 A · ISO 3316

Adapter
DIN 3123 A · ISO 3316



Bestell-No./Order-No.	Art. No.			mm		
50825150183	50825-1501	3/8"	1/4"	25	21	10

Verbindungselemente	Adaptateur	Adapters
für Bohrmaschinen und Akkuschauber	pour perceuse et visseuse à batterie	voor boor- en schroefmachines

50833-2



Bit-Box-Satz, 32-tlg.
Chrom-Vanadium, gesandstrahlt, mit magnetischem Schnellwechseladapter und Adapter für 1/4" Vierkant-Halter, mit formschlüssiger Arretierung, mit Gürtelhalter und Bohrung für Wandaufhängung

Jeu d'embouts de 32 pcs.
Chrome-Vanadium, sablé, avec adaptateur magnétique à éjection rapide, et adaptateur pour porte-outil 1/4" carré avec adaptateur de ceinture et trou de suspension murale

Bitbox, set 32 delig
Chroom-Vanadium, gezandstraalt, met magnetische snelwisseladapter en adapter voor 1/4" vierkant aansluiting, met broekriemclip en ophangoog voor wandbevestiging

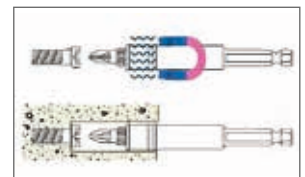

- R1/R2
- 3,5/4,5/5,5/6,5/8
- PH1/PH2(2x)/PH3
- PZ1/PZ2(2x)/PZ3
- 2/3/4/5/6/7/8
- TT9/10/15/20/25/27/30/40

Bestell-No./Order-No.	Art. No.	Maße · Dimensions		
5083320000	50833-2	105 x 65 x 40 mm	250	1
*50833201000	50833-2-10	105 x 65 x 40 mm	2500	10

*Lieferung im Verkaufsdisplay • Delivery in sale display • Livraison en présentoirs

Verbindungselemente

für Bohrmaschinen und Akkuschrauber

Adaptateur

pour perceuse et visseuse à batterie

Adapters

voor boor- en schroefmachines

50833-3



Bit-Box-Satz, 31-tlg. mit Bit-Knarre

Chrom-Vanadium, gesandstrahlt, mit Adapter für 1/4" Vierkant-Halter, mit Gürtelhalter Bit-Knarre, 48 Zähne

Jeu d'embouts de 31 pces. avec bit cliquet

Chrome-Vanadium, sablé, avec adaptateur pour porte-outil 1/4" carré avec adaptateur de ceinture Bit cliquet, 48 dents

Bitbox, set 31 delig met ratelbithouder

Chroom-Vanadium, gezandstraald met Adapter voor 1/4" vierkant aansluiting, met broekriemclip, 48 tanden



■ R1/R2

○ 3,5/4,5/5,5/6,5/8

⊕ PH1/PH2(2x)/PH3

⊗ PZ1/PZ2(2x)/PZ3

⬡ 2/3/4/5/6/7/8

⚙ TT9/10/15/20/25/27/30/40



Bestell-No./Order-No.	Art. No.	Maße · Dimensions	g	Stk
50833300000	50833-3	105 x 65 x 40 mm	358	1
*50833301000	50833-3-10	105 x 65 x 40 mm	3580	12

*Lieferung im Verkaufsdisplay • Delivery in sale display • Livraison en présentoirs

50833-4



Bit-Box-Satz, 33-tlg.

Chrom-Vanadium, gesandstrahlt, mit Adapter für 1/4" Sechskant-Halter, mit Gürtelhalter

Jeu d'embouts de 33 pces.

Chrome-Vanadium, sablé, avec adaptateur pour porte-outil 1/4" carré avec adaptateur de ceinture

Bitbox, set 33 delig

Chroom-Vanadium, gezandstraald met Adapter voor 1/4" sechskant aansluiting, met broekriemclip



Adapter/Tool-holder



○ 3/4/5/5,5/6,5

⊕ PH1/PH2(2x)/PH3

⊗ PZ1/PZ2(2x)/PZ3

⬡ 2/2,5/3/4/5/6

⚙ T8/9/10/15(2x)/20(2x)/25(2x)/27/30/40



Bestell-No./Order-No.	Art. No.	Maße · Dimensions	g	Stk
50833400000	50833-4	105 x 85 x 45 mm	295	1
*50833401200	50833-4-12	105 x 85 x 45 mm	3540	12

*Lieferung im Verkaufsdisplay • Delivery in sale display • Livraison en présentoirs

Verbindungselemente

für Bohrmaschinen und Akkuschrauber

Adaptateur

pour perceuse et visseuse à batterie

Adapters

voor boor- en schroefmachines

50833-5



Bit-Box-Satz, 32-tlg.

Chrom-Vanadium, gesandstrahlt, Mini-Bit-Knarre, 48 Zähne, magnetischer Schnellwechseladapter mit Arretierung, mit Gürtelhalter

Jeu d'embouts de 32 pces.







Chrome Vanadium, sablé, cliquet mini-bit, 48 dents, adaptateur magnétique changement rapide avec serrure, avec support de ceinture

Bitbox, set 32 delig met ratelbithouder



Chroom Vanadium, gezandstraald, mini bit ratel, 48 tand, magnetische snelwisseladapter, met riemhouder

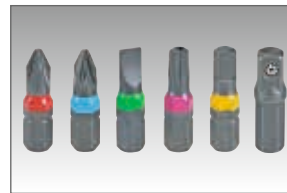

enthaltend/containing/composition

-  85 mm
-  95 mm
-  3,5/4,5/5,5/6,5/8
-  PH1(2x)/PH2(2x)/PH3
-  PZ1/PZ2(2x)/PZ3
-  2/3/4/5/6/7/8
-  TT9/10/15/20/25/27/30/40



Bestell-No./Order-No.	Art. No.	Maße · Dimensions		
50833500000	50833-5	105 x 65 x 40 mm	300	1

9083312-3



Adapter-Satz, 3-tlg.

Chrom-Vanadium-Stahl, gesandstrahlt, je 1 Adapter 1/4", 3/8", 1/2" Vierkant mit Kugel, Länge 75 mm für Maschinenbetrieb, 1/4" Sechskant Antrieb





Jeu de adaptateurs de 3 pces.

Acier au Chrome-Vanadium, sablé, 1 adaptateur de chaque à carré de 1/4", 3/8", 1/2" avec bille, longueur 75 mm pour utilisation sur machine, entraînement hexagonal 1/4"

Adapterset, 3-dlg.

Chroom-vanadium, gezandstraald, elk 1 adapter 1/4", 3/8", 1/2" vierkant met kogel, lengte 75 mm voor machinegebruik, 1/4" zeskant aansluiting



Bestell-No./Order-No.	Art. No.		 mm		
90833120305	9083312-3	1/4"	65	20	10
		3/8"	65	26	
		1/2"	65	32	

Verbindungselemente für Bohrmaschinen und Akkuschrauber	Adaptateur pour perceuse et visseuse à batterie	Adapters voor boor- en schroefmachines
--	--	--

9083314



SDS-Adapter Chrom-Vanadium-Stahl, gesand- strahlt, zur Adaptierung von Steckschleuseinsätzen auf SDS- Maschinen	Adaptateur SDS Acier au Chrome-Vanadium, sablé, pour l'adaptation des douilles sur des machines SDS	SDS adapter Chroom vanadium staal, gezandstraald, voor gebruik van dopsleutels op SDS machines
--	---	--



Bestell-No./Order-No.	Art. No.		mm		
90833140005	9083314	1/2"	65	50	10

50833-465



Bit-Adapter für Bohrmaschinen und Akkuschrauber Chrom-Vanadium, verchromt, extra schlanke Ausführung mit magnetischer und formschlüssiger Arretierung. Für enge Bauräume.	Adaptateur embouts de tournevis pour perceuses et visseuse Chrome-Vanadium, chromées, exécution extra mince avec blocage magnétique et positive. Idéal pour les petits espaces.	Bit adapter voor boor- en accuboormachines Chroom-Vanadium, verchromd, extra slanke uitvoering met magnetische en vormvaste vergrendeling. Ideaal voor krappe bouwruimtes.
---	---	--



Bestell-No./Order-No.	Art. No.	mm			
50833046500	50833-465	95	250 g	71	1

50825-3015



Steckschlüsselgarnitur, 44-tlg. Chrom-Vanadium, verchromt, in Kunststoffkoffer	Compositions de douilles, 44 pcs. Chrome-Vanadium, chromées, en coffret plastique	Dopsleutelset, 44 delig Chroom-Vanadium, verchromd, in kunststof koffer
--	---	---



enthaltend/containing/composition

	150 mm
	150 mm
	MM 4/4,5/5/5,5/6/7/8/9/10/11/12/13
	MM 6/7/8/9/10/11/12/13
	50 / 100 mm
	37 mm
	M 5/6/8
	PH 1/2/3
	3/4/5/6
	4/5,5
	TT 10/15/20/25/27/30/40

Bestell-No./Order-No.	Art. No.	Maße · Dimensions		
50825301583	50825-3015	280 x 220 x 60 mm	1600	1

50828-3015

T-Griff Steckschlüssel-Garnitur, 29-tlg.

Chrom-Vanadium, verchromt, mit 2-K Schaumstoffeinlage in Metallkasten

Compositions de douilles avec manche-T, 29 pces.

Chrome-Vanadium, chromées, avec intérieur mousse à 2 composants en coffret métallique

Dopsleutelset, T-greep met ratelfunctie, 29 delig

Chroom-Vanadium, verchromd, met 2 componenten schuimleg in metalen koffer



enthaltend/containing/composition	
	115 mm
	MM 4/4,5/5/6/7/8/9/10/11/12/13
	100 / 250 mm
	37 mm
	PZ 1/2
	3/4/5/6
	4/5,5
	TT 15/20/25/27/30/40



Bestell-No./Order-No.	Art. No.	Maße · Dimensions		
50828301583	50828-3015	407 x 162 x 52 mm	1860	1

50829-3016

Steckschlüsselgarnitur, 45-tlg.

Chrom-Vanadium, verchromt, mit 2-K Schaumstoffeinlage in Metallkasten

Compositions de douilles, 45 pces.

Chrome-Vanadium, chromées, avec intérieur mousse à 2 composants en coffret métallique

Dopsleutelset, 45 delig

Chroom-Vanadium, verchromd, met 2 componenten schuimleg in metalen koffer



enthaltend/containing/composition	
	150 mm
	115 mm
	150 mm
	37 mm
	50 mm
	MM 4/4,5/5/5,5/6/7/8/9/10/11/12/13/14
	PZ 1/2/3
	PH 1/2/3
	3/4/5/6
	4/5,5/7
	TT 8/10/15/20/25/27/30/40
	E 4/5/6/7/8/10

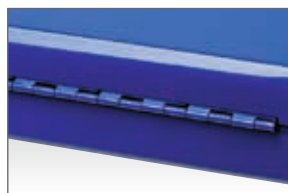
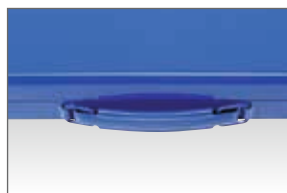

Bestell-No./Order-No.	Art. No.	Maße · Dimensions		
50829301683	50829-3016	320 x 140 x 55 mm	2180	1



Bestseller

Werkzeuggarnituren sind unsere Spezialität und erfreuen sich großer Beliebtheit bei den Anwendern. Nicht zuletzt deswegen, weil wir hier auf kleinstem Raum Sortimente zusammengestellt haben, die eine Vielzahl an Anwendungsmöglichkeiten bieten. Wir denken immer praxisorientiert, damit Sie in jedem Bedarfsfall bestens ausgestattet sind.

Bestsellers

Tool sets are our speciality, and are enormously popular with users. Not least because we pack ranges of tools for a multitude of different applications into the smallest space. Our approach to this is practice-oriented and guarantees that you have the right tools to hand whenever you need them.

50825-5015 Steckschlüsselgarnitur

Weitere Informationen

zum Produkt siehe Seite 68

50825-5015 Socket set

For further product information

see page 68



50829-3017

Steckschlüssel- und Bits-garnitur, 22-tlg.

Chrom-Vanadium, verchromt, in Kunststoffkoffer

Compositions de douilles, 22 pces.

Chrome-Vanadium, chromées, en coffret plastique

Dopsleutelset, 22 delig

Chroom-Vanadium, verchromd, in kunststof koffer



Mit arretierbarer Gelenkknarre + Gürtelclip
Avec cliquet articulé blocable + adaptateur de ceinture
Met knikbare ratel en riemclip

enthaltend/containing/composition

	140 mm
	MM 5/6/7/8/10/11/12/13
	50 mm
	50 mm
	25 mm
	100 mm
	PH 1/2
	4/5,5
	TT 10/15/20/25/27



Bestell-No./Order-No.	Art. No.	Maße · Dimensions		
50829301783	50829-3017	160 x 102 x 36 mm	575	1

50829-3018

Steckschlüssel- und Bits-garnitur, 44-tlg.

Chrom-Vanadium, verchromt, mit 2-K Schaumstoffeinlage in Kunststoffbox

Compositions de douilles, 44 pces.

Chrome-Vanadium, chromées, avec intérieur mousse à 2 composantes en coffret plastique

Dopsleutelset, 44 delig

Chroom-Vanadium, verchromd, met 2 componenten schuimleg in kunststof koffer



enthaltend/containing/composition

	115 mm
	MM 6 - 13
	50 mm
	1/4"
	100 mm
	110 mm
	85 mm
	PZ 1/2/2/3/4
	PH 1/2/2/3
	2/3/4/5/6/7/8
	3,5/4,5/5,5/6,5
	TT 7/8/9/10/15/20/25/27/30/40

Bestell-No./Order-No.	Art. No.	Maße · Dimensions		
50829301883	50829-3018	145 x 102 x 50 mm	765	1

50829-3019

Steckschlüsselgarnitur, 25-tlg.

Chrom-Vanadium, verchromt, mit 2-K Schaumstoffeinlage in Kunststoffbox

Compositions de douilles, 25 pces.

Chrome-Vanadium, chromées, avec intérieur mousse à 2 composantes en coffret plastique

Dopsleutelset, 25 delig

Chroom-Vanadium, verchromd, met 2 componenten schuimleg in kunststof koffer



enthaltend/containing/composition	
	MM 4/4,5/5/5,5/6/7/8/9/10/11/12/13
	115 mm
	100 mm
	1/4"
	PZ 2
	PH 2
	5/6
	TT 10/15/20/25/30/40

Bestell-No./Order-No.	Art. No.	Maße · Dimensions		
50829301983	50829-3019	145 x 102 x 50 mm	775	1

50829-3020

Steckschlüssel- und Bitsgarnitur, 46-tlg.

- Hebelumschaltknarre, mit Auswerferstift zum Schnellösen der Steckverbindung, 48 Zähne
- Hochwertiger Chrom-Vanadium Stahl DIN 3123 B · ISO 3316
- Einsätze mit Schraubenschonprofil
- Adapter für 1/4" Bits
- Top Finish
- Ergonomischer Softgriff
- Hochwertiger 2-Komponenten Schaumstoff
- In Kunststoffbox

Compositions de douilles et embouts, 46 pces.

- Cliquet réversible à levier, avec bouton de déverrouillage qui permet le retrait facile, 48 dents
- Chrome vanadium de haute qualité
- Acier DIN 3123 B · ISO 3316
- Prises d'économiseur de profil
- Adaptateur pour 1/4" bits
- Finition supérieure
- Soft grip ergonomique
- Matériel mousse 2 composants de haute qualité
- Boîte plastique

Dopsleutel- en bitset, 46-dlg.

- Omschakelbare ratel, met ontgrendelstift voor voor snel wisselen van dopsleutels, 48 tand
- Hoogwaardig chroom-vanadium staal DIN 3123 B · ISO 3316
- Dopsleutels met profielbescherming
- Adapter voor 1/4" bits
- Top Finish
- Ergonomische soft grip
- Hoogwaardig 2-comp. schuimstof
- in kunststof koffer



enthaltend/containing/composition	
	115 mm
	100 mm
	65 mm
	MM 4/4,5/5/5,5/6/7/8/9/10/11/12/13
	25 mm
	2/3/4/5/6/7/8
	PH 1/2/2/3
	PZ 1/2/2/3/4
	3,5/4,5/5,5/6,5
	TT 7/8/9/10/15/20/25/27/30/40

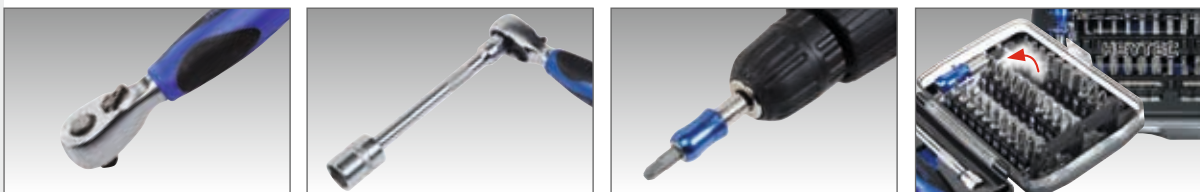

Bestell-No./Order-No.	Art. No.	Maße · Dimensions		
new 50829302083	50829-3020	145 x 105 x 50 mm	700	1



50840-00-15

Antriebs- und Verbindungsteile Chrom-Vanadium, verchromt	Accessoires Chrome-Vanadium, chromées	Ratels en hulpstukken Chroom-Vanadium, verchromd
Hebelumschaltknarre Mit Auswerferstift zum Schnelllösen der Steckverbindung, 48 Zähne Mit ergonomischem 2-K Griff DIN 3122 D · ISO 3315	Cliquets réversibles Tige d'éjection pour libérer rapidement l'outil du cliquet, 48 dents Avec poignée ergonomique à 2 composantes DIN 3122 D · ISO 3315	Omschakelbare ratel Met pal, met ontgrendelstift, 48 tanden Met ergonomische 2 componenten greep DIN 3122 D · ISO 3315



Bestell-No./Order-No.	Art. No.		\varnothing mm		
50840015083	50840-00-15	3/8"	200	285	5

50840-10-17

Hebelumschaltknarre Mit Auswerferstift zum Schnelllösen der Steckverbindung, 60 Zähne Mit ergonomischem 2-K Griff Extrem schlank, bestens geeignet für enge Bauräume. 30% mehr Drehmoment durch innovative Sperrfunktion	Cliquets réversibles Tige d'éjection pour libérer rapidement l'outil du cliquet, 60 dents Avec poignée ergonomique à 2 composantes Extrêmement mince, parfaitement adaptée aux petits espaces 30% plus de couple grâce à la fonction de barrière innovante	Omschakelbare ratel Met ontgrendelstift, 60 tanden Met ergonomische 2 componenten greep Extreem slanke uitvoering, uitermate geschikt voor krappe werkrumtes 30% meer draaimoment door innovatieve blokkeerfunctie
--	---	---

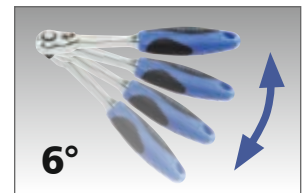

Bestell-No./Order-No.	Art. No.		\varnothing mm		
50840101783	50840-10-17	3/8"	205	280	5

50840-03

Griff mit Gleitstück DIN 3122 A · ISO 3315	Poignée coulissante DIN 3122 A · ISO 3315	Greep met schuifstuk DIN 3122 A · ISO 3315
--	---	--



Bestell-No./Order-No.	Art. No.		\varnothing mm		
50840030083	50840-03	3/8"	150	205	10

3/8"

3/8"

50840-04-1/04

Verbindungssteile

Chrom-Vanadium, verchromt

Accessoires

Chrome-Vanadium, chromées

Hulpstukken

Chroom-Vanadium, verchromd

Verlängerungen

DIN 3123 B · ISO 3316

Rallonges

DIN 3123 B · ISO 3316

Verlengstukken

DIN 3123 B · ISO 3316



50840-04-1

50840-04

Bestell-No./Order-No.	Art. No.			CL mm		
50840041083	50840-04-1		3/8"	75	75	10
50840040083	50840-04		3/8"	150	140	10

50840-06

Kardangelen

DIN 3123 C · ISO 3316

Cardan universel

DIN 3123 C · ISO 3316

Kardangewricht

DIN 3123 C · ISO 3316



Bestell-No./Order-No.	Art. No.			CL mm		
50840060083	50840-06		3/8"	55	65	10

**50840-14
50840-15**

Adapter

DIN 3123 A · ISO 3316

Réducteur

DIN 3123 A · ISO 3316

Adapter

DIN 3123 A · ISO 3316



3/8"

1/4"

1/2"

Bestell-No./Order-No.	Art. No.			CL mm		
50840140083	50840-14		3/8"	25	68	10
50840150083	50840-15		3/8"	45	70	10

50850-14-1

Gleitstück für
Verlängerung

DIN 3123 A · ISO 3316

Coulisseau à adapter

DIN 3123 A · ISO 3316

Schuifstuk voor verlengstuk

DIN 3123 A · ISO 3316



1/2"

3/8"

Bestell-No./Order-No.	Art. No.			CL mm		
50850141083	50850-14-1		1/2"	40	70	10

50840-1401

Adapter

DIN 3123 A · ISO 3316

Réducteur

DIN 3123 A · ISO 3316

Adapter

DIN 3123 A · ISO 3316



3/8"

1/4"

Bestell-No./Order-No.	Art. No.			CL mm		
50840140183	50840-1401		3/8"	25	19	10



50840-1501

Verbindungssteile Chrom-Vanadium, verchromt	Accessoires Chrome-Vanadium, chromées	Hulpstukken Chroom-Vanadium, verchromd
--	--	---

Adapter DIN 3123 A · ISO 3316	Réducteur DIN 3123 A · ISO 3316	Adapter DIN 3123 A · ISO 3316
----------------------------------	------------------------------------	----------------------------------



Bestell-No./Order-No.	Art. No.	■	○	CLØ mm	△ g	▭
50840150183	50840-1501	1/2"	3/8"	35	43	10

Einsätze mit Schon-Profil und Kreuzrändelung

Super-Oberflächen-Verarbeitung, Oberfläche in Matt-Finish. Mehr Grip durch Kreuzrändelung. Schon-Profil schützt Schrauben und Muttern.

Douilles avec profil de protection et moletage en croix

Parfaite finition des surfaces, surfaces en finition mat, meilleur contact grâce au moletage en croix, le profil spécial protège les boulons et écrous.

Dopsleutels met profiel bescherming

Superieure oppervlak behandeling, oppervlak in matte finish meer grip door geribbeld profiel. Profiel bescherming beschermt bouten en moeren.

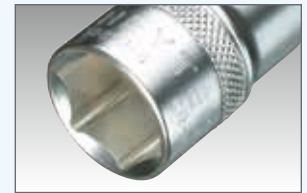

50840-6



Steckschlüsseleinsätze, sechskant

DIN 3124 / ISO 2725
Chrom-Vanadium, verchromt

Douilles, 6 pans

DIN 3124 / ISO 2725
Chrome-Vanadium, chromées

Schroevendraaier dopsleutels, zeskant

DIN 3124 / ISO 2725
Chroom-Vanadium, verchromd

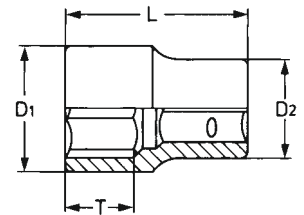

Bestell-No./Order-No.	MM	CLØ mm	T mm	D1 mm	D2 mm	△ g	▭
50840600883	8	25,5	10,0	12,5	12,0	20	10
50840600983	9	28,0	10,0	17,0	13,0	22	10
50840601083	10	28,0	12,0	14,5	17,0	23	10
50840601183	11	25,5	12,0	15,5	17,0	24	10
50840601283	12	25,5	10,0	17,0	17,0	25	10
50840601383	13	25,5	11,0	18,5	17,0	26	10
50840601483	14	25,5	15,0	20,0	18,0	30	10
50840601583	15	25,5	15,0	21,0	19,5	33	10
50840601683	16	25,5	16,0	22,0	19,5	34	10
50840601783	17	25,5	17,0	23,0	20,0	35	10
50840601883	18	26,0	17,0	24,5	21,0	40	10
50840601983	19	26,5	17,0	26,0	23,0	46	10
50840602083	20	32,0	18,0	27,0	24,0	68	10
50840602183	21	32,0	18,0	28,0	25,0	70	10
50840602283	22	32,0	18,0	29,5	26,5	82	10
50840602483	24	32,0	18,0	32,0	28,0	95	10

50840-19-1
50840-19-3



Zündkerzeneinsätze
DIN 3124 / ISO 2725

Chrom-Vanadium, verchromt
mit Gummisicherung

Douilles
pour bougies

Chrome-Vanadium, chromées
avec bague de caoutchouc

Bougiedopsleutel
DIN 3124 / ISO 2725

Chroom-Vanadium, verchromd
met rubber inleg

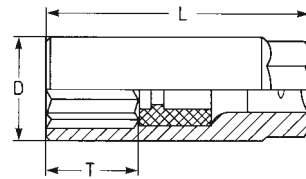

Bestell-No./Order-No.	MM	mm	T mm	D mm	MM	g	
50840190183	20,8	70,0	25,0	27,0	24	160	10
50840190383	16	65,0	20,0	22,5	19	100	10

50840-3015



Steckschlüsselgarnitur,
23-tlg.

Chrom-Vanadium, verchromt,
in Kunststoffkoffer

Compositions de douilles,
23 pces.

Chrome-Vanadium, chromées,
en coffret plastique

Dopsleutelset,
23 delig

Chroom-Vanadium, verchromd,
in kunststof koffer



enthaltend/containing/composition

	200 mm
	MM 8/9/10/11/12/13/14/15/16/ 17/18/19/20/21/22/24
	MM 16/20,8
	150 mm
	75 mm
	55 mm

Bestell-No./Order-No.	Art. No.	Maße · Dimensions	g	
50840301583	50840-3015	280 x 220 x 60 mm	2000	1

50842-3015



Steckschlüsselgarnitur,
15-tlg.

Chrom-Vanadium, verchromt,
in Metallkasten

Compositions de douilles,
15 pces.

Chrome-Vanadium, chromées,
en coffret métallique

Dopsleutelset,
15 delig

Chroom-Vanadium, verchromd,
in metalen koffer



enthaltend/containing/composition

	MM 8/10/12/13/14/15/17/19/21/22/24
	200 mm
	75 / 150 mm
	55 mm

Bestell-No./Order-No.	Art. No.	Maße · Dimensions	g	
50842301583	50842-3015	250 x 150 x 40 mm	1650	1



Den Anwender im Blick

Entscheidend für den Anwender ist der hohe Gebrauchsnutzen unserer Werkzeuge. Funktionalität, ergonomisches Design, Sicherheit und Zuverlässigkeit sind hierbei die wesentlichen Faktoren, die dazu beitragen, dass sich unsere Werkzeuge optimal den ständig wechselnden Arbeitsbedingungen anpassen.

Focused on users

The high usability of our tools is a decisive factor for users. Functionality, ergonomic design, safety and reliability are essential factors that play an important role in ensuring that our tools are ideally adapted to constantly changing working conditions.





50750-01

Antriebsteile Chrom-Vanadium, verchromt	Accessoires Chrome-Vanadium, chromées	Ratels Chroom-Vanadium, verchromd
Durchsteckknarre mit Verbindungsvierkant, 2-flg.	Cliquet avec carré conducteur, 2 pces.	Doorsteekratel met verbindingsvierkant, 2 delig
DIN 3122 C Chrom-Vanadium, verchromt	DIN 3122 C Chrome-Vanadium, chromées	DIN 3122 C Chroom Vanadium, verchromd



Bestell-No./Order-No.	Art. No.		mm	g	
50750010080	50750-01	1/2"	260	490	5

50750-01-1

Durchsteckknarre, ohne Verbindungsvierkant	Cliquet, sans carré conducteur	Doorsteekratel, zonder verbindingsvierkant
DIN 3122 C Chrom-Vanadium, verchromt	DIN 3122 C Chrome-Vanadium, chromées	DIN 3122 C Chroom-Vanadium, verchromd



Bestell-No./Order-No.	Art. No.	mm	g	
50750010180	50750-01-1	260	430	5

90050-16

Verbindungsvierkant DIN 3122 CV · ISO 3315	Carré conducteur DIN 3122 CV · ISO 3315	Verbindingsvierkant DIN 3122 CV · ISO 3315
Chrom-Vanadium, verchromt, für 1/2" Verbindungen	Chrome-Vanadium, chromées, pour 1/2" connexions	Chroom-Vanadium, verchromd, voor 1/2" hulpstukken



Bestell-No./Order-No.	Art. No.		mm	g	
90050160083	90050-16	1/2"	37	45	10



50850-00-15

Antriebssteile Chrom-Vanadium, verchromt	Accessoires Chrome-Vanadium, chromées	Ratels Chroom-Vanadium, verchromd
Hebelumschaltknarre Mit Auswerferstift zum Schnelllösen der Steckverbindung, 48 Zähne	Cliquets réversibles Tige d'éjection pour libérer rapidement l'outil du cliquet, 48 dents	Omschakelbare ratel Met pal, met ontgrendelstift 48 tanden
Mit ergonomischem 2-K Griff DIN 3122 D · ISO 3315	Avec poignée ergonomique à 2 composantes DIN 3122 D · ISO 3315	Met ergonomische 2 componenten greep DIN 3122 D · ISO 3315



Bestell-No./Order-No.	Art. No.		mm	g	mm
50850015083	50850-00-15	1/2"	250	555	5

50850-10-16

Hebelumschaltknarre Gebogener Stahlkern, 72 Zähne	Cliquets réversibles Poignée en acier déporté, 72 dents	Omschakelbare ratel Gebogen stalen kern, 72 tanden
---	---	--



Bestell-No./Order-No.	Art. No.		mm	g	mm
50850101680	50850-10-16	1/2"	255	510	5

50850-10-17

Hebelumschaltknarre Mit Auswerferstift zum Schnelllösen der Steckverbindung, 60 Zähne	Cliquets réversibles Tige d'éjection pour libérer rapidement l'outil du cliquet, 60 dents	Omschakelbare ratel Met ontgrendelstift, 60 tanden
Mit ergonomischem 2-K Griff Extrem schlank, bestens geeignet für enge Bauräume.	Avec poignée ergonomique à 2 composantes Extrêmement mince, parfaitement adaptée aux petits espaces	Met ergonomische 2 componenten greep Extreem slanke uitvoering, uitermate geschikt voor krappe werkrumtes
30% mehr Drehmoment durch innovative Sperrfunktion	30% plus de couple grâce à la fonction de barrière innovante	30% meer draaimoment door innovatieve blokkeerfunctie

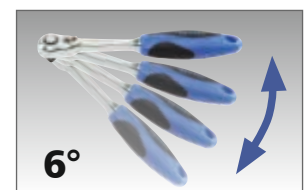
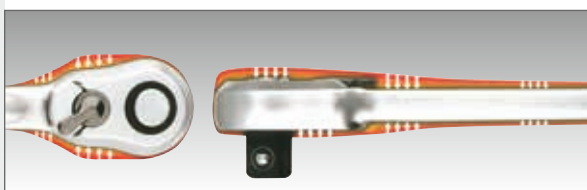

Bestell-No./Order-No.	Art. No.		mm	g	mm
50850101783	50850-10-17	1/2"	260	555	5



50850-03

Verbindungssteile	Accessoires	Hulpstukken
Chrom-Vanadium, verchromt	Chrome-Vanadium, chromées	Chroom-Vanadium, verchromd

Griff mit Gleitstück | Poignée coulissante | Greep met schuifstuk
 DIN 3122 A · ISO 3315 | DIN 3122 A · ISO 3315 | DIN 3122 A · ISO 3315



Bestell-No./Order-No.	Art. No.			mm		
50850030083	50850-03	1/2"		250	500	10

50850-04/05

Verlängerungen | Rallonges | Verlengstukken
 DIN 3123 B · ISO 3316 | DIN 3123 B · ISO 3316 | DIN 3123 B · ISO 3316

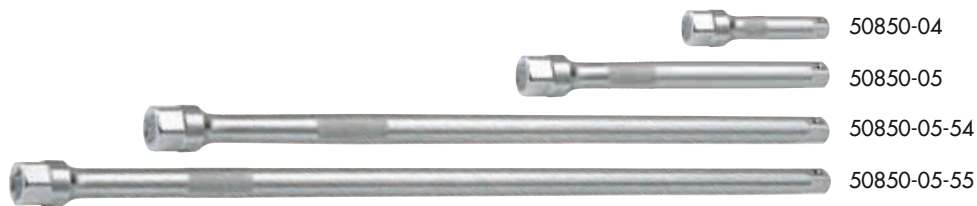

Bestell-No./Order-No.	Art. No.			mm		
50850040083	50850-04	1/2"		125	200	10
50850050083	50850-05	1/2"		250	420	10
50850055483	50850-05-54	1/2"		400	670	10
50850055583	50850-05-55	1/2"		500	850	5

50850-04-6/ 50850-05-6

Verlängerungen mit LED-Licht | Rallonges avec LED | Verlengstukken met LED licht
 Chrom-Vanadium in Matt-Finish, mehr Grip durch Kreuzrändelung | Chrome-Vanadium en finition mat, meuleur contact grâce au moletage en croix. | Chroom-Vanadium, in matte finish, meer grip dankzij kartelrand.

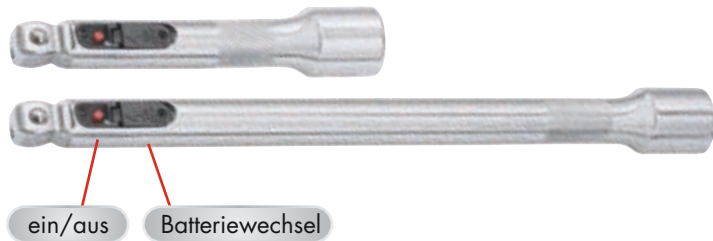

Bestell-No./Order-No.	Art. No.			mm		
50850046083	50850-04-6	1/2"		125	214	10
50850056083	50850-05-6	1/2"		250	418	10
50850456083	50850-45-6	1/2"		125+250	630	1

50850-04-5/ 05-5

Schwenkbare Verlängerungen | Rallonges articulées | Zwenbare verlengstukken



Bestell-No./Order-No.	Art. No.			mm		
50850045083	50850-04-5	1/2"		125	200	10
50850055083	50850-05-5	1/2"		250	420	10

Verbindungsteile	Accessoires	Hulpstukken
Chrom-Vanadium, verchromt	Chrome-Vanadium, chromées	Chroom-Vanadium, verchromd

50850-06

Kardangelen
DIN 3123 C · ISO 3316

Cardan universel
DIN 3123 C · ISO 3316

Kardangewricht
DIN 3123 C · ISO 3316



Bestell-No./Order-No.	Art. No.			CL mm		
50850060083	50850-06		1/2"	75	150	10

50850-14-1/ 50840-15

Gleitstücke für
Verlängerung
DIN 3123 A · ISO 3316

Coulisse à adapter
DIN 3123 A · ISO 3316

Schuifstukken voor
verlengstuk
DIN 3123 A · ISO 3316



50850-14-1



50840-15



Bestell-No./Order-No.	Art. No.			CL mm		
50850141083	50850-14-1	1/2"	3/8"	40	70	10
50840150083	50840-15	3/8"	1/2"	45	70	10

50850-1401

Adapter
DIN 3123 A · ISO 3316

Réducteur
DIN 3123 A · ISO 3316

Adapter
DIN 3123 A · ISO 3316



Bestell-No./Order-No.	Art. No.			CL mm		
50850140183	50850-1401	3/8"	1/2"	35	46	10

50850-1501

Adapter
DIN 3123 A · ISO 3316

Réducteur
DIN 3123 A · ISO 3316

Adapter
DIN 3123 A · ISO 3316



Bestell-No./Order-No.	Art. No.			CL mm		
50850150183	50850-1501	3/4"	1/2"	50	142	10

Einsätze mit Schon-Profil und Kreuzrändelung

Douilles avec profil de protection et moletage en croix

Dopsleutels met profiel bescherming

50850-6



Steckschlüsseinsätze, sechskant

DIN 3124 / ISO 2725
Chrom-Vanadium, verchromt

Douilles, 6 pans

DIN 3124 / ISO 2725
Chrome-Vanadium, chromées

Dopsleutels, zeskant

DIN 3124 / ISO 2725
Chroom-Vanadium, verchromd

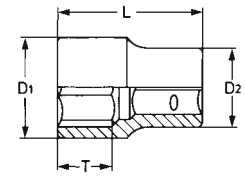

Bestell-No./Order-No.	MM	CL mm	T mm	D1 mm	D2 mm	g	mm
50850600883	8	38,5	14,0	13,5	22,0	48	10
50850600983	9	38,5	14,0	14,5	22,0	48	10
50850601083	10	38,5	14,0	15,5	22,0	54	10
50850601183	11	38,5	14,0	16,5	22,0	51	10
50850601283	12	38,5	14,0	17,5	22,0	50	10
50850601383	13	38,5	14,0	18,5	22,0	50	10
50850601483	14	38,5	14,0	20,0	22,0	53	10
50850601583	15	38,5	14,0	21,5	22,0	55	10
50850601683	16	38,5	14,0	22,5	22,0	63	10
50850601783	17	38,5	14,0	24,0	22,5	66	10
50850601883	18	38,5	14,0	25,0	23,0	71	10
50850601983	19	38,5	20,0	25,0	24,5	74	10
50850602083	20	38,5	20,0	28,0	25,5	84	10
50850602183	21	38,5	20,0	28,0	26,5	84	10
50850602283	22	38,5	20,0	30,0	28,0	105	10
50850602383	23	40,0	20,0	32,0	28,0	116	10
50850602483	24	40,5	22,0	32,0	30,0	120	10
50850602783	27	42,5	22,0	36,0	34,0	170	10
50850603083	30	42,5	22,0	40,0	36,5	205	10
50850603283	32	45,0	25,0	42,0	38,0	235	10
new 50850603483	34	46,0	43,9	37,0	22,0	241	10
new 50850603683	36	46,0	47,9	37,8	22,0	274	10

new
new

50850-79
98718-50



Leiste für Steckschlüssel-einsätze

Zur Aufnahme von zehn 1/2" Steckschlüsseleinsätzen. Die Einsätze und die Leiste werden mit Hilfe von Magnetleisten gehalten.

Bornes pour douilles

Blocage des bornes dues aux aimantes et les surfaces métalliques.

Strip voor dopsleutels

Voor 10 dopsleutels 1/2". De dopsleutels worden door magneten op hun plek gehouden.



Bestell-No./Order-No.	Art. No.	MM	CL mm	g	mm
50850790083	50850-79	10/11/12/13/15/17/19/21/22/24	320	1210	1
98718500000	98718-50	leer/empty	320	600	1



Testsieger

Unser Bestreben ist es, gutes Werkzeug stetig zu verbessern. Deshalb scheuen wir auch nicht den Vergleich mit anderen Herstellern. Unabhängige Praxistests und Prüfungen bestätigen uns immer wieder, dass unsere Werkzeuge eine Spitzenposition einnehmen. Für uns ist das die Bestätigung, dass wir auf dem richtigen Weg sind. Zugleich ist es ein Ansporn für die Zukunft, so weiterzuagieren – damit Sie die Sicherheit haben, immer über bestes Werkzeug zu verfügen.

Test winners

As we constantly strive to improve tools that are already good, we never fear comparisons with other manufacturers. Independent bench testing and field tests repeatedly confirm that our tools are among the best. For us, this confirms that we are on the right track. At the same time, it inspires and motivates us to follow this track into the future to give you the certainty of having the best tools in your hands.





AUSGEZEICHNETE BEWERTUNG EXCELLENT RATINGS



50850-6



Steckschlüsseinsätze,
sechskant, AF-Größen
DIN 3124 / ISO 2725

Chrom-Vanadium, verchromt



Douilles,
6 pans, AF

Chrome-Vanadium, chromées

Dopsleutels,
zeskant, AF

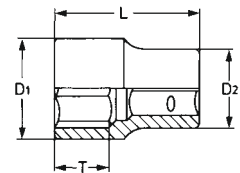
Chroom-Vanadium, verchromd



Bestell-No./Order-No.	 AF	\varnothing mm	T mm	D1 mm	D2 mm	 g	
50850631983	3/8"	38,0	12,0	15,0	22,0	49	10
50850632183	7/16"	38,0	12,0	16,3	22,0	50	10
50850632383	1/2"	38,0	12,0	18,8	22,0	51	10
50850632583	9/16"	38,0	12,0	20,4	22,0	53	10
50850632783	5/8"	38,0	12,0	22,9	22,0	61	10
50850632983	11/16"	38,0	12,0	24,0	22,0	68	10
50850633183	3/4"	38,0	14,0	26,0	23,0	73	10
50850633383	13/16"	38,0	14,0	28,0	25,0	82	10
50850633483	7/8"	40,0	14,0	30,0	26,0	106	10
50850633583	15/16"	42,0	16,0	32,0	28,0	121	10
50850633783	1"	42,0	16,0	34,0	30,0	150	10
50850633883	1.1/16"	43,0	18,0	36,0	30,0	168	10
50850633983	1.1/8"	43,0	20,0	38,0	32,0	205	10
50850634083	1.3/16"	46,0	22,0	40,0	34,0	225	10
50850634183	1.1/4"	46,0	22,0	42,0	36,0	225	10



50850-19



Steckschlüsseinsätze,
extra lang
DIN 3124 / ISO 2725

Chrom-Vanadium, verchromt

Douilles,
extra longues

Chrome-Vanadium, chromées

Dopsleutels,
extra lang

Chroom-Vanadium, verchromd

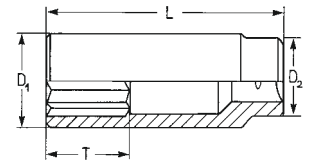

Bestell-No./Order-No.	MM	CL mm	T mm	D1 mm	D2 mm	g	mm
50850191083	10	77,0	35,0	14,8	22,0	86	10
50850191383	13	77,0	35,0	18,8	22,0	105	10
50850191483	14	77,0	35,0	20,5	22,0	105	10
50850191583	15	77,0	35,0	22,0	22,0	115	10
50850191783	17	77,0	35,0	24,0	22,0	130	10
50850191983	19	77,0	35,0	26,0	23,0	145	10
50850192283	22	77,0	35,0	26,0	24,0	160	10
50850192483	24	77,0	35,0	28,0	24,0	170	10

50850-19-1 50850-19-3



Zündkerzeneinsätze
DIN 3124 / ISO 2725

Chrom-Vanadium, verchromt
mit Gummisicherung

Douilles pour bougies

Chrome-Vanadium, chromées
avec bouge de caoutchouc

Bougiedopsleutel

Chroom-Vanadium, verchromd

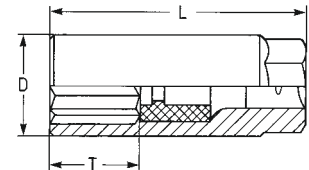

Bestell-No./Order-No.	Art. No.	MM	AF	CL mm	T mm	D mm	MM	g	mm
50850190383	50850-19-3	16,0	5/8"	67,0	26,0	22,0	20,0	90	10
new 50850190483	50850-19-4	18,0	11/16"	67,0	26,0	24,5	22,0	140	10
50850190183	50850-19-1	20,8	13/16"	67,0	26,0	27,5	24,0	130	10

50850-20



Steckschlüsseinsätze
für Außen-TORX®-
Schrauben

Chrom-Vanadium, verchromt

Douilles pour vis
TORX® exterieures

Chrome-Vanadium, chromées

Dopsleutels voor
TORX® bouten

Chroom-Vanadium, verchromd

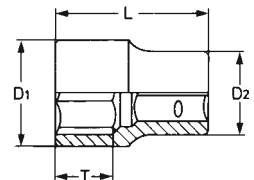

Bestell-No./Order-No.	E	mm	CL mm	T mm	D1 mm	D2 mm	g	mm
50850201083	E 10	9,42	38,0	14,0	15,0	22,0	53	10
50850201183	E 11	10,08	38,0	14,0	15,0	22,0	53	10
50850201283	E 12	11,17	38,0	14,0	15,0	22,0	53	10
50850201483	E 14	12,90	38,0	14,0	17,0	22,0	55	10
50850201683	E 16	14,76	38,0	14,0	19,0	22,0	55	10
50850201883	E 18	16,70	38,0	14,0	21,0	24,0	73	10
50850202083	E 20	18,49	38,0	14,0	24,0	22,0	68	10
50850202283	E 22	20,32	38,0	14,0	26,0	23,0	80	10
50850202483	E 24	22,16	38,0	14,0	28,0	24,0	96	10

50850-31
50850-33



Schraubendreher-
Einsätze

Chrom-Vanadium, verchromt

Douilles tournevis

Chrome-Vanadium, chromées

Schroevendraaier
dopsleutels

Chroom-Vanadium, verchromd



50850-31



Bestell-No./Order-No.	Art. No.	MM	L1 mm	L2 mm	D2 mm	g	
50850310083	50850-31-0	4	62,0	24,0	18,0	85	10
50850311383	50850-31-13	4	138,0	100,0	18,0	118	5
50850310283	50850-31-2	5	62,0	24,0	18,0	87	10
50850311483	50850-31-14	5	138,0	100,0	18,0	118	5
50850310383	50850-31-3	6	62,0	24,0	18,0	88	10
50850312283	50850-31-22	6	100,0	62,0	18,0	105	5
50850311583	50850-31-15	6	138,0	100,0	18,0	118	5
50850310183	50850-31-1	7	62,0	24,0	18,0	90	10
50850311683	50850-31-16	7	138,0	100,0	18,0	120	5
50850310483	50850-31-4	8	62,0	24,0	18,0	90	10
50850312483	50850-31-24	8	100,0	62,0	18,0	107	5
50850311283	50850-31-12	8	138,0	100,0	18,0	122	5
50850310583	50850-31-5	10	62,0	24,0	18,0	93	10
50850312583	50850-31-25	10	100,0	62,0	18,0	120	5
50850311183	50850-31-11	10	138,0	100,0	18,0	144	5
50850310683	50850-31-6	12	62,0	24,0	20,0	102	10
50850312683	50850-31-26	12	100,0	62,0	20,0	142	5
50850311883	50850-31-18	12	138,0	100,0	20,0	175	5
50850310783	50850-31-7	14	62,0	24,0	22,0	120	10
50850312783	50850-31-27	14	100,0	62,0	22,0	173	5
50850311783	50850-31-17	14	138,0	100,0	22,0	217	5
50850310883	50850-31-8	17	62,0	24,0	26,0	158	10
50850311083	50850-31-10	17	138,0	100,0	26,0	305	5
50850310983	50850-31-9	19	62,0	24,0	26,0	168	10
50850311983	50850-31-19	19	138,0	100,0	26,0	350	5

50850-33



XZN

Bestell-No./Order-No.	Art. No.		L1 mm	L2 mm	D2 mm	g	
50850330183	50850-33-1	M 5	62,0	24,0	18,0	86	10
50850332183	50850-33-21	M 5	138,0	100,0	18,0	118	5
50850330283	50850-33-2	M 6	62,0	24,0	18,0	88	10
50850331283	50850-33-12	M 6	100,0	62,0	18,0	102	5
50850332283	50850-33-22	M 6	138,0	100,0	18,0	118	5
50850330383	50850-33-3	M 7	62,0	24,0	18,0	88	10
50850332383	50850-33-23	M 7	138,0	100,0	18,0	119	5
50850330483	50850-33-4	M 8	62,0	24,0	18,0	88	10
50850331483	50850-33-14	M 8	100,0	62,0	18,0	104	5
50850332483	50850-33-24	M 8	138,0	100,0	18,0	120	5
50850330583	50850-33-5	M 10	62,0	24,0	18,0	91	10
50850331583	50850-33-15	M 10	100,0	62,0	18,0	118	5
50850332583	50850-33-25	M 10	138,0	100,0	18,0	140	5
50850330683	50850-33-06	M 12	62,0	24,0	20,0	100	10
50850331683	50850-33-16	M 12	100,0	62,0	20,0	139	5
50850332683	50850-33-26	M 12	138,0	100,0	20,0	170	5
50850330783	50850-33-07	M 14	62,0	24,0	22,0	113	10
50850332783	50850-33-27	M 14	138,0	100,0	22,0	212	5

50850-34
50850-36
50850-37

Schraubendreher-
Einsätze

Douilles tournevis

Schroevendraaier
dopsleutels

Chrom-Vanadium, verchromt

Chrome-Vanadium, chromées

Chroom-Vanadium, verchromd

50850-34



Bestell-No./Order-No.	Art. No.		L1 mm	L2 mm	D2 mm		
50850340183	50850-34-1	M 5	62,0	24,0	18,0	87	10
50850342183	50850-34-21	M 5	138,0	100,0	18,0	118	5
50850340283	50850-34-2	M 6	62,0	24,0	18,0	88	10
50850342283	50850-34-22	M 6	138,0	100,0	18,0	119	5
50850340383	50850-34-3	M 7	62,0	24,0	18,0	88	10
50850342383	50850-34-23	M 7	138,0	100,0	18,0	119	5
50850340483	50850-34-4	M 8	62,0	24,0	18,0	89	10
50850342483	50850-34-24	M 8	138,0	100,0	18,0	119	5
50850340583	50850-34-5	M 10	62,0	24,0	18,0	91	10
50850342583	50850-34-25	M 10	138,0	100,0	18,0	141	5
50850340683	50850-34-06	M 12	62,0	24,0	20,0	101	10
50850342683	50850-34-26	M 12	138,0	100,0	20,0	173	5
50850340783	50850-34-07	M 14	62,0	24,0	22,0	114	10
50850342783	50850-34-27	M 14	138,0	100,0	22,0	212	5

50850-36



Bestell-No./Order-No.	Art. No.			L1 mm	L2 mm	D2 mm		
50850362083	50850-36-20	T 20	3,86	62,0	24,0	18,0	86	10
50850361083	50850-36-10	T 20	3,86	138,0	100,0	18,0	117	5
50850362583	50850-36-25	T 25	4,43	62,0	24,0	18,0	86	10
50850361183	50850-36-11	T 25	4,43	138,0	100,0	18,0	119	5
50850362783	50850-36-27	T 27	4,99	62,0	24,0	18,0	86	10
50850361283	50850-36-12	T 27	4,99	138,0	100,0	18,0	119	5
50850363083	50850-36-30	T 30	5,62	62,0	24,0	18,0	87	10
50850360383	50850-36-3	T 30	5,62	100,0	62,0	18,0	100	5
50850361383	50850-36-13	T 30	5,62	138,0	100,0	18,0	118	5
50850364083	50850-36-40	T 40	6,65	62,0	24,0	18,0	88	10
50850360483	50850-36-4	T 40	6,65	100,0	62,0	18,0	102	5
50850361483	50850-36-14	T 40	6,65	138,0	100,0	18,0	120	5
50850364583	50850-36-45	T 45	7,82	62,0	24,0	18,0	88	10
50850361583	50850-36-15	T 45	7,82	138,0	100,0	18,0	120	5
50850365083	50850-36-50	T 50	8,83	62,0	24,0	18,0	90	10
50850360683	50850-36-6	T 50	8,83	100,0	62,0	18,0	115	5
50850361683	50850-36-16	T 50	8,83	138,0	100,0	18,0	120	5
50850365583	50850-36-55	T 55	11,22	62,0	24,0	18,0	92	10
50850361783	50850-36-17	T 55	11,22	138,0	100,0	18,0	142	5
50850366083	50850-36-60	T 60	13,25	62,0	24,0	20,0	100	10
50850360883	50850-36-8	T 60	13,25	100,0	62,0	20,0	138	5
50850361883	50850-36-18	T 60	13,25	138,0	100,0	20,0	173	5
50850367083	50850-36-70	T 70	13,25	62,0	24,0	22,0	114	10
50850361983	50850-36-19	T 70	13,25	138,0	100,0	22,0	213	5

50850-37



Bestell-No./Order-No.	Art. No.			L1 mm	L2 mm	D2 mm		
50850372083	50850-37-20	TT20	3,86	62,0	24,0	18,0	86	10
50850372583	50850-37-25	TT25	4,43	62,0	24,0	18,0	86	10
50850372783	50850-37-27	TT27	4,99	62,0	24,0	18,0	86	10
50850373083	50850-37-30	TT30	5,62	62,0	24,0	18,0	86	10
50850374083	50850-37-40	TT40	6,65	62,0	24,0	18,0	87	10
50850374583	50850-37-45	TT45	7,82	62,0	24,0	18,0	88	10
50850375083	50850-37-50	TT50	8,83	62,0	24,0	18,0	88	10
50850375583	50850-37-55	TT55	11,22	62,0	24,0	18,0	90	10
50850376083	50850-37-60	TT60	13,25	62,0	24,0	20,0	100	10

50880-1

Einsatzspender, leer

Zur Aufbewahrung und Präsentation von Steckschlüsseinsätzen und Schraubendrehereinsätzen aller Art. Variable Einteilung durch Trennsystem. Zusammenstellung von Sortimenten nach eigenem Belieben möglich.

Présentoirs combinés, vide

Pour présentation de douilles et douilles tournevis. Un système variable de cloisonnement permet des compositions différentes au choix.

Dopsleuteldisplay, leeg

Voor het opbergen en presenteren van dopsleutels en schroevendraaierdopsleutels. Variabele indeling door verdeelschotten. Assortiment naar eigen wens samen te stellen.

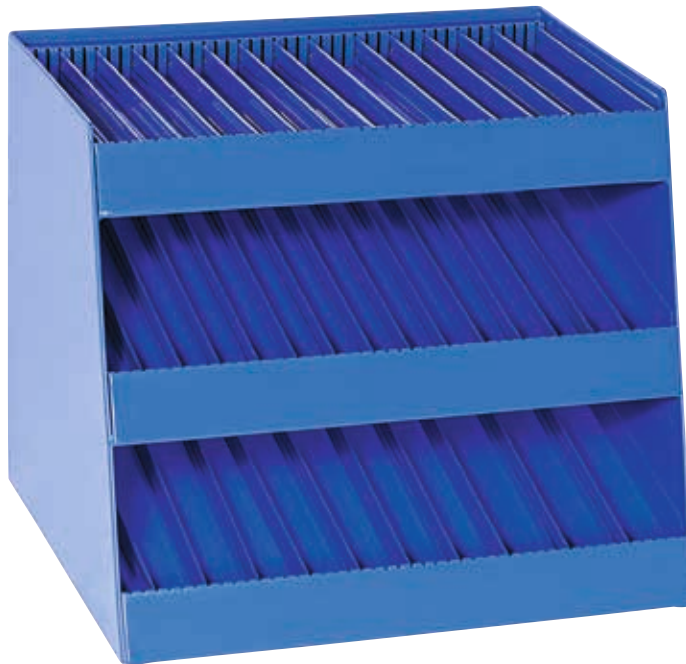

Bestell-No./Order-No.	Art. No.	Maße · Dimensions		
5088000020	50880-1	350 x 420 x 350 mm	9700	1

50825-65

Einsatzspender 1/4"

mit 1/4" Sortiment, 491-tlg.

Présentoirs combinés 1/4"

avec 1/4" assortiment, 491 pces.

Dopsleuteldisplay 1/4"

met 1/4" assortiment, 491-dlg



enthaltend/containing/composition

	je 10 Stk./pcs.	MM 4/4,5/5/5,5/6/7/8/9/10/11/12/13
	je 10 Stk./pcs.	MM 6/7/8/9/10/11/12/13
	je 10 Stk./pcs.	E 4/5/6/7/8/10
	je 10 Stk./pcs.	4/5,5
	je 10 Stk./pcs.	PH 1/2
	je 10 Stk./pcs.	PZ 1/2
	je 10 Stk./pcs.	MM 3/4/5/6
	je 10 Stk./pcs.	TT 10/15/20/25/27/30/40
	37 mm	/ je 10 Stk./pcs.
	50 mm	/ je 10 Stk./pcs.
	100 mm	/ je 10 Stk./pcs.
	115 mm	/ je 10 Stk./pcs.
	150 mm	/ je 10 Stk./pcs.
	150 mm	/ je 10 Stk./pcs.

Abbildung enthält Sonderausstattung · Picture shows extras

Bestell-No./Order-No.	Art. No.	Maße · Dimensions		
50825006583	50825-65	350 x 420 x 350 mm	21300	1

50850-65

Einsatzspender 1/2"

mit 1/2" Sortiment, 332-tlg.

Présentoirs combinés 1/2"

avec 1/2" assortiment, 332 pces.

Dopsleuteldisplay 1/2"

met 1/2" assortiment, 332-dlg



enthaltend/containing/composition		
	je 10 Stk./pcs.	MM 8/9/10/11/12/13/14/15/16
	je 10 Stk./pcs.	MM 17/18/19/20/21/22/23/24/27/30/32
	je 7 Stk./pcs.	E 10/11/12/14/16/18
	je 7 Stk./pcs.	MM 6/8/10/12/14
	je 7 Stk./pcs.	T 25/27/30/40/45
	je 7 Stk./pcs.	M 6/8/10/12

Abbildung enthält Sonderausstattung · Picture shows extras

Bestell-No./Order-No.	Art. No.	Maße · Dimensions		
5085006583	50850-65	350 x 420 x 350 mm	36600	1

50825-5065

Einsatzspender 1/4" + 1/2"

mit 1/4" + 1/2" Sortiment, 442-tlg.

Présentoirs combinés 1/4" + 1/2"

avec 1/4" + 1/2" assortiment, 442 pces.

Dopsleuteldisplay 1/4" + 1/2"

met 1/4" + 1/2" assortiment, 442-dlg



enthaltend/containing/composition		
	je 10 Stk./pcs.	MM 4/4,5/5/5,5/6/7/8/9/10/11/12/13/14/15
	je 10 Stk./pcs.	7
	je 10 Stk./pcs.	PH 2
	je 10 Stk./pcs.	MM 3/4/5/6
	je 10 Stk./pcs.	MM 8/9/10/11/12/13/14/15/16/17/18/19/20/21/22/23/24
	je 7 Stk./pcs.	27/30/32
	je 10 Stk./pcs.	MM 6/8/10/12/14

Abbildung enthält Sonderausstattung · Picture shows extras

Bestell-No./Order-No.	Art. No.	Maße · Dimensions		
50825506583	50825-5065	350 x 420 x 350 mm	33300	1

50872-3015
50873-3015

Steckschlüsselgarnitur,
19*/21**-tlg.

Chrom-Vanadium, verchromt,
in Metallkasten

Compositions de douilles,
19*/21** pces.

Chrome-Vanadium, chromées,
en coffret métallique

Dopsleutelset,
19*/21** delig

Chroom-Vanadium, verchromd,
in metalen koffer



enthaltend/containing/composition

	250 mm
	250 mm 125 mm
	75 mm
	3/8" 1/2"
	MM 10/11/12/13/14/15/16/ 17/19/22/24/ 27/30/32

Bestell-No./Order-No.	Art. No.*	Maße · Dimensions		
50872301583	50872-3015	407 x 162 x 52 mm	3910	1



enthaltend/containing/composition

wie · comme · hoe 50872-3015 +

	MM 16/20,8
--	------------

Bestell-No./Order-No.	Art. No.**	Maße · Dimensions		
50873301583	50873-3015	407 x 162 x 52 mm	4130	1

50870-3015
50870-3115

Steckschlüsselgarnitur,
13-tlg.

Chrom-Vanadium, verchromt,
in Metallkasten

Compositions de douilles,
13 pces.

Chrome-Vanadium, chromées,
en coffret métallique

Dopsleutelset,
13 delig

Chroom-Vanadium, verchromd,
in metalen koffer



enthaltend/containing/composition

	250 mm
	125 mm
	MM 8/10/11/13/15/17/18/19/22/24
	MM 20,8

Bestell-No./Order-No.	Art. No.	Maße · Dimensions		
50870301583	50870-3015	318 x 119 x 49 mm	2300	1



enthaltend/containing/composition

	250 mm
	125 mm
	MM 8/10/11/13/15/17/18/19/22/24
	75 mm

Bestell-No./Order-No.	Art. No.	Maße · Dimensions		
50870311583	50870-3115	318 x 119 x 49 mm	2310	1

50852-2016

Steckschlüsselgarnitur, 21-tlg., AF

Chrom-Vanadium, verchromt, mit 2-K Schaumstoffeinlage in Metallkasten

Compositions de douilles, 21 pces., AF

Chrome-Vanadium, chromées, avec intérieur mousse à 2 composants en coffret métallique

Dopsleutelset, 21 delig, AF

Chroom-Vanadium, verchromd, met 2 componenten schuimleg in metalen koffer



enthaltend/containing/composition	
	255 mm
	250 mm
	125 mm
	75 mm
	AF 3/8" / 7/16" / 1/2" / 9/16" / 5/8" / 11/16" / 3/4" / 13/16" / 7/8" / 15/16" / 1" / 1.1/16" / 1.1/8" / 1.3/16" / 1.1/4"
	AF 5/8" / 13/16"



Bestell-No./Order-No.	Art. No.	Maße · Dimensions		
50852201683	50852-2016	440 x 180 x 55 mm	5180	1

50853-3015

Steckschlüsselgarnitur, 39-tlg.

Chrom-Vanadium, verchromt, in Kunststoffkoffer

Compositions de douilles, 39 pces.

Chrome-Vanadium, chromées, en coffret plastique

Dopsleutelset, 39 delig

Chroom-Vanadium, verchromd, in kunststof koffer



enthaltend/containing/composition	
	250 mm
	250 mm
	125 mm
	75 mm
	MM 10/11/12/13/14/15/16/17/18/19/20/21/22/23/24/27/30/32
	MM 16/20,8
	MM 10/13/17/19
	CL 62 mm 5/6/8/10/12/14
	CL 62 mm TT 30/40/45/50

Bestell-No./Order-No.	Art. No.	Maße · Dimensions		
50853301583	50853-3015	350 x 280 x 80 mm	5500	1

50854-3016



Steckschlüsselgarnitur,
28-tlg.

Chrom-Vanadium, verchromt,
mit 2-K Schaumstoffeinlage in
Metallkasten

Compositions de douilles,
28 pces.

Chrome-Vanadium, chromées,
avec intérieur mousse à 2
composantes en coffret métallique

Dopsleutelset,
28 delig

Chroom-Vanadium, verchromd,
met 2 componenten schuiminleg
in metalen koffer



enthaltend/containing/composition

	255 mm
	250 mm
	125 mm
	75 mm
	MM 10/11/12/13/14/15/16/17/18/19/ 20/21/22/23/24/27/30/32
	MM 16/20,8
	MM 10/13/17/19

Bestell-No./Order-No.	Art. No.	Maße · Dimensions		
50854301683	50854-3016	440 x 180 x 55 mm	5670	1

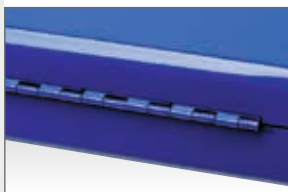
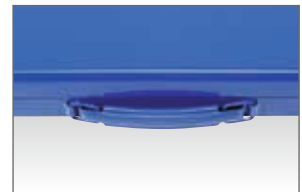



Detailverliebt

Manchmal sind es die Kleinigkeiten, die unsere Werkzeuge so einzigartig machen. Doch gerade diese Details sorgen für den Unterschied, wenn es um Arbeitserleichterung, längere Lebensdauer und Zuverlässigkeit geht. Hier zeigt sich einmal mehr, dass wir an alles denken, damit Sie von unseren Werkzeugen begeistert sind.

Our passion for details

Sometimes, it is the smallest things that make our tools so unique. But, when it comes to reducing the workload, extending service life and ensuring reliability, these are the details that make the difference. This is one more example that shows that we think of everything to make sure you are delighted by our tools.



50883-3016



Steckschlüsselgarnitur, 61-tlg.

Chrom-Vanadium, verchromt, mit 2-K Schaumstoffeinlage in Metallkasten

Compositions de douilles, 61 pces.

Chrome-Vanadium, chromées, avec intérieur mousse à 2 composants en coffret métallique

Dopsleutelset, 61 delig

Chroom-Vanadium, verchromd, met 2 componenten schuimleg in metalen koffer



enthaltend/containing/composition			
	150 + 255 mm		
	250 mm		
	115 + 250 mm		
	150 mm		
	50 + 125 mm		
	37 + 75 mm		
	MM 4/4,5/5/5,5/6/7/8/9/10/11/12/13		
	MM 14/15/16/17/18/19/20/21/22/23/24/27/30/32		
	MM 16/20,8		
	PH 1/2/3		
	3/4/5/6		
	4/5,5/7		
	TT 8/10/15/20/25/27/30/40		
	E 4/5/6/7/8/10		

Bestell-No./Order-No.	Art. No.	Maße · Dimensions		
50883301683	50883-3016	430 x 250 x 65 mm	6000	1

50884-3015



Steckschlüsselgarnitur mit 4 in 1 Knarren-Ringschlüssel, 31-tlg.

Chrom-Vanadium, verchromt, in Kunststoffkoffer

Coffret de douilles avec clés polygonales à cliquet 4 en 1, 31 pcs.

Chrome-Vanadium, chromées, en coffret plastique

Dopsleutelset met 4 in 1 ratelringsleutels, 31 delig

Chroom-Vanadium, verchromd, in kunststof koffer



enthaltend/containing/composition

- 250 mm
- MM
8 x 10 x 12 x 13 /
9 x 11 x 14 x 15 /
16 x 17 x 18 x 19 /
20 x 21 x 22 x 24
- 3/8" 1/2"
- 125 / 250 mm
- 75 mm
- MM 8/9/10/11/12/13/
14/15/16/17/18/19/20/
21/22/23/24/27/30/32
- MM 16/20,8



Bestell-No./Order-No.	Art. No.	Maße · Dimensions	g	
50884301583	50884-3015	350 x 280 x 80 mm	4980	1



50825-5015

Steckschlüsselgarnitur, 105-tlg.

Chrom-Vanadium, verchromt, in Kunststoffkoffer

Compositions de douilles, 105 pcs.

Chrome-Vanadium, chromées, en coffret plastique

Dopsleutelset, 105 delig

Chroom-Vanadium, verchromd, in kunststof koffer



Heytec 104-tellige Steckschlüssel-Garnitur

Vertrieb: Heytec, Rosenfeld um 180 Euro
 Preis: 0 21 91 / 2 09-0
 Internet: www.heytec.de

Bewertung: ★★★★★

Note:

Funktion:	20%	1,2	★★★★★
Robuster:	20%	1,2	★★★★★
Steckschlüsselgröße:	20%	1,2	★★★★★
Bedienung:	16%	1,2	★★★★★
Anschaffung:	16%	1,2	★★★★★

Überklasse

Heimwerker Praktikum Klasse 10/11

1,3

Preis-Leistung gut - sehr gut



enthaltend/containing/composition

	150 mm	
	50 / 100 mm	
	115 mm	
	37 mm	
	150 mm	
	MM 4/4,5/5/5,5/6/7/8/9/10/11/12/13/14	
	MM 6/7/8/9/10/11/12/13	
	250 mm	
	125 / 250 mm	
	3/8" 1/2"	
	75 mm	
	MM 10/11/12/13/14/15/16/17/18/19/20/21/22/23/24/27/30/32	
	MM 14/15/17/19	
	MM 16/20,8	
	3/4/5/6	
	TT 8/10/15/20/25/27/30	
	R1-R2	
	3,5-8	
	2-8	



Bestell-No./Order-No.	Art. No.	Maße · Dimensions		
50825501583	50825-5015	420 x 320 x 75 mm	6500	1

50860-3015



Kombinierte Steck-
schlüssel- und Ringmaul-
schlüsselgarnitur, 33-tlg.

Chrom-Vanadium, verchromt,
in Metallkasten

Composition de douilles
et clés mixtes, 33 pcs.

Chrome-Vanadium, chromées,
en coffret métallique

Gecombineerde
dopsleutel- en ring-
steeksleutelset, 33 delig

Chroom-Vanadium, verchromd,
in metalen koffer



enthaltend/containing/composition

	250 mm
	250 mm
	125 mm
	70 mm
	MM 10/11/12/13/14/ 15/17/18/19/22/24/ 27/30/32
	MM 16/20,8
	MM 6/7/8/10/11/12/ 13/14/15/17/19/21/22

Bestell-No./Order-No.	Art. No.	Maße · Dimensions		
50860301580	50860-3015	450 x 187 x 52 mm	5600	1

50850-52



Schraubendreher-
ersatz-Sortiment, 27-tlg.

Chrom-Vanadium, verchromt,
für Innen- und Aussen-TORX®-
Schrauben in Kunststoffkoffer

Composition de douilles-
tournevis, 27 pcs.

Chrome-Vanadium, chromées,
en coffret plastique pour vis
TORX® int et ext.

Schroevendraaier
dopsleutelset, 27 delig

Chroom-Vanadium, verchromd,
voor binnen- en buiten TORX®
bouten, in kunststof koffer



enthaltend/containing/composition

		62 mm	T 20/25/27/30/40/45/50/55/60/70
		138 mm	T 20/25/27/30/40/45/50/55/60/70
		50 mm	E 10/12/14/16/18/20/24

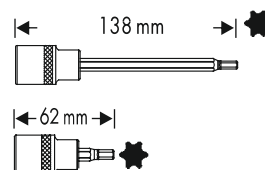

Bestell-No./Order-No.	Art. No.	Maße · Dimensions		
50850520083	50850-52	350 x 280 x 80 mm	3615	1

50850-53

1/2"



Schraubendreher-einsatz-Sortiment, 33-tlg.

Chrom-Vanadium, verchromt, in Kunststoffkoffer

Composition de douilles-tournevis, 33 pces.

Chrome-Vanadium, chromées, en coffret plastique

Schroevendraaier dopsleutelset, 33 delig

Chroom-Vanadium, verchromd, in kunststof koffer



enthaltend/containing/composition

	CL	62 mm	MM 5/6/7/8/10/12/14/17
	CL	62 mm	TT 25/27/30/40/45/50/55/60
	CL	62 mm	M 5/6/8/10
	CL	100 mm	MM 6/8/10/12/14
	CL	100 mm	T 30/40/50/60
	CL	100 mm	M 6/8/10/12

← 62 mm →



← 100 mm →



Bestell-No./Order-No.	Art. No.	Maße · Dimensions		
50850530083	50850-53	350 x 280 x 80 mm	4400	1

50850-54

1/2"



Schraubendreher-einsatz-Sortiment, 28-tlg.

Chrom-Vanadium, verchromt, für Schrauben mit Innen-RIBE und Vielzahn XZN-Köpfen, in Kunststoffkoffer

Composition de douilles-tournevis, 28 pces.

Chrome-Vanadium, chromées, int. pour vis XZN int. multi-dents en coffret plastique

Schroevendraaier dopsleutelset, 28 delig

Chroom-Vanadium, verchromd, voor schroeven met interne-RIBE en meertands XZN-koppen, in kunststof koffer



enthaltend/containing/composition

	CL	62 mm	M 5/6/7/8/10/12/14
	CL	62 mm	M 5/6/7/8/10/12/14
	CL	138 mm	M 5/6/7/8/10/12/14
	CL	138 mm	M 5/6/7/8/10/12/14

← 138 mm →



← 62 mm →

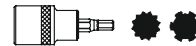

Bestell-No./Order-No.	Art. No.	Maße · Dimensions		
50850540083	50850-54	350 x 280 x 80 mm	4230	1

50850-55



Schraubendreher-einsatz-Sortiment, 18-tlg.

Chrom-Vanadium, verchromt, in Metallkasten

Composition de douilles-tournevis, 18 pcs.

Chrome-Vanadium, chromées, en coffret métallique

Schroevendraaier dopsleutelset, 18 delig

Chroom-Vanadium, verchromd, in metalen koffer



enthaltend/containing/composition

$\frac{1}{2}$ 62 mm T 20/25/27/30/40/45/50/55/60/70

$\frac{1}{4}$ 37 mm TT 8/10/15/20/25/27/30/40

Bestell-No./Order-No.	Art. No.	Maße · Dimensions		
50850550083	50850-55	220 x 120 x 40 mm	1500	1

50850-56



Schraubendreher-einsatz-Sortiment, 7-tlg.

Chrom-Vanadium, verchromt, in Metallkasten

Composition de douilles-tournevis, 7 pcs.

Chrome-Vanadium, chromées, en coffret métallique

Schroevendraaier dopsleutelset, 7 delig

Chroom-Vanadium, verchromd, in metalen koffer



enthaltend/containing/composition

62 mm 6/7/8/10/12/14/17



Bestell-No./Order-No.	Art. No.	Maße · Dimensions		
50850560283	50850-56	250 x 150 x 40 mm	1570	1

50850-58



Schraubendreher-einsatz-Sortiment, 14-tlg.

Chrom-Vanadium, verchromt, in Metallkasten

Composition de douilles-tournevis, 14 pces.

Chrome-Vanadium, chromées, en coffret métallique

Schroevendraaier dopsleutelset, 14 delig

Chroom-Vanadium, verchromd, in metalen koffer



enthaltend/containing/composition

62 mm 4/5/6/7/8/10/12/14/17/19

36 mm 3/4/5/6

Bestell-No./Order-No.	Art. No.	Maße · Dimensions		
50850580083	50850-58	220 x 120 x 40 mm	1590	1

50850-59



Schraubendreher-einsatz-Sortiment, 9-tlg.

Chrom-Vanadium, verchromt, im Metallkasten, für Tamper-TORX®-Schrauben

Composition de douilles-tournevis, 9 pces.

Chrome-Vanadium, chromées, en coffret métallique, pour vis TORX® avec trou

Schroevendraaier dopsleutelset, 9 delig

Chroom-Vanadium, verchromd, in metalen koffer, voor inwendige TORX® schroeven met stift



enthaltend/containing/composition

62 mm TT 20/25/27/30/40/45/50/55/60



Bestell-No./Order-No.	Art. No.	Maße · Dimensions		
50850590083	50850-59	250 x 150 x 40 mm	1650	1

50850-55-12



Schraubendreher-einsatz-Sortiment, 20-tlg.

Chrom-Vanadium, verchromt, für Innensechskantschrauben in Kunststoffkoffer

Composition de douilles-tournevis, 20 pces.

Chrome-Vanadium, chromées, en coffret plastique pour vis hexagonales int.

Schroevendraaier dopsleutelset, 20 delig

Chroom-Vanadium, verchromd, voor binnezekantbouten in kunststof koffer



enthaltend/containing/composition

CL 62 mm 4/5/6/7/8/10/12/14/17/19

CL 138 mm 4/5/6/7/8/10/12/14/17/19

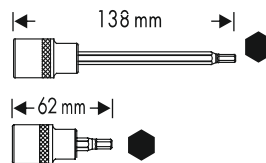

Bestell-No./Order-No.	Art. No.	Maße · Dimensions		
5085051283	50850-55-12	350 x 280 x 80 mm	3765	1

50851-3015



Steckschlüsselgarnitur, 18-tlg.

Chrom-Vanadium, verchromt, in Kunststoffkoffer

Compositions de douilles, 18 pces.

Chrome-Vanadium, chromées, en coffret plastique

Dopsleutelset, 18 delig

Chroom-Vanadium, verchromd, in kunststof koffer



enthaltend/containing/composition

250 mm

250 mm

125 mm

75 mm

MM 10/11/12/13/14/
15/17/19/21/24/27/30/32

Bestell-No./Order-No.	Art. No.	Maße · Dimensions		
50851301583	50851-3015	350 x 280 x 80 mm	3500	1



508100-00-6

Antriebs- und Verbindungsteile Chrom-Vanadium, verchromt	Accessoires Chrome-Vanadium, chromées	Ratels en hulpstukken Chroom-Vanadium, verchromd
---	--	---

Umschaltknarre Mit Druckbetätigung zum Schnelllösen und zur Arretierung der Steckverbindung, 72 Zähne DIN 3122 D · ISO 3315	Cliquets réversibles Tige d'éjection pour libérer rapidement l'outil du cliquet, 72 dents DIN 3122 D · ISO 3315	Omschakelbare ratel Met ontgrendelstift 72 tanden DIN 3122 D · ISO 3315
---	---	---



Bestell-No./Order-No.	Art. No.		CL mm		
50810000680	508100-00-6	3/4"	510	1700	2

508100-13

Durchsteckknarre mit Verbindungsvierkant, 2-tlg. DIN 3122 C Chrom-Vanadium, verchromt	Cliquet avec carré conducteur, 2 pces. DIN 3122 C Chrome-Vanadium, chromées	Doorsteekratel met verbindingsvierkant, 2 delig DIN 3122 C Chroom Vanadium, verchromd
---	---	---



Bestell-No./Order-No.	Art. No.		CL mm		
50810011380	508100-13	3/4"	472	1485	1

508100-03

Griff mit Gleitstück DIN 3122 A · ISO 3315	Poignée coulissantes DIN 3123 B · ISO 3316	Greep met schuifstuk DIN 3123 B · ISO 3316
---	---	---



Bestell-No./Order-No.	Art. No.		CL mm		
50810003080	508100-03	3/4"	455	1360	2

508100-04/04-1/05

Verlängerungen DIN 3123 B · ISO 3316	Rallonges DIN 3123 B · ISO 3316	Verlengstukken DIN 3123 B · ISO 3316
---	------------------------------------	---

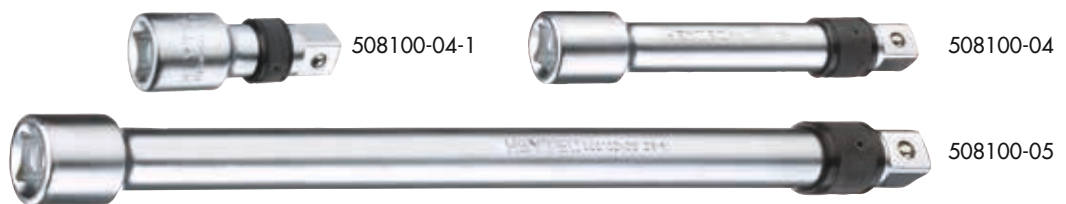

Bestell-No./Order-No.	Art. No.		CL mm		
50810004180	508100-04-1	3/4"	100	440	2
50810004080	508100-04	3/4"	200	840	2
50810005080	508100-05	3/4"	400	1560	2

Einsätze mit Schon-Profil
und Kreuzrändelung

Douilles avec profil de
protection et moletage
en croix

Dopsleutels met profiel
bescherming

508100-6



Steckschlüsseinsätze,
sechskant

DIN 3124 / ISO 2725
Chrom-Vanadium, verchromt

Douilles,
6 pans

DIN 3124 / ISO 2725
Chrome-Vanadium, chromées

Dopsleutels,
zeskant

DIN 3124 / ISO 2725
Chroom-Vanadium, verchromd

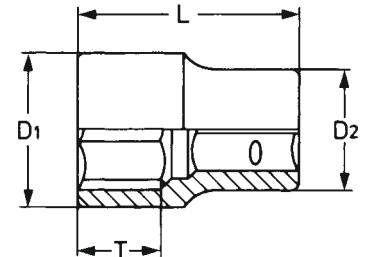

Bestell-No./Order-No.	MM	mm	T mm	D1 mm	D2 mm	g	
50810061980	19	50	15	29	33	168	5
50810062180	21	50	15	31	33	172	5
50810062280	22	50	15	33	36	211	5
50810062380	23	50	15	33	36	211	5
50810062480	24	50	15	34	36	225	5
50810062680	26	52	26	37	36	223	5
50810062780	27	52	26	38	36	224	5
50810062980	29	52	26	40	38	262	5
50810063080	30	54	26	42	38	285	5
50810063280	32	56	28	44	38	305	5
50810063480	34	56	26	47	36	390	5
50810063580	35	58	30	48	42	395	5
50810063680	36	58	30	50	42	434	5
50810063880	38	60	30	52	45	472	5
50810064180	41	64	36	56	45	550	5
50810064680	46	68	36	62	48	685	5
50810065080	50	72	40	68	48	800	5
50810065580	55	76	38	74	45	860	5
50810066080	60	78	42	80	45	1020	5

50810-1401



Adapter
DIN 3123 A · ISO 3316

Réducteur
DIN 3123 A · ISO 3316

Adapter
DIN 3123 A · ISO 3316



Bestell-No./Order-No.	Art. No.	1/2"	3/4"	mm	g	
50810140180	50810-1401	1/2"	3/4"	50	206	10

508101-310

Steckschlüsselgarnitur,
21-tlg.

Chrom-Vanadium, verchromt,
in Kunststoffkoffer

Compositions de douilles,
21 pces.

Chrome-Vanadium, chromées,
en coffret plastique

Dopsleutelset,
21 delig

Chroom-Vanadium, verchromd,
in kunststof koffer



enthaltend/containing/composition



510 mm



MM 19/21/22/23/24/26/27/29/30/
32/35/36/38/41/46/50



100 / 200 / 400 mm



455 mm



Bestell-No./Order-No.

50810131080

Art. No.

508101-310

Maße · Dimensions

580 x 400 x 90 mm



14000



1



Werkstattwagen und Module

- Stabile Metallkonstruktion
- Verwindungssteif und hochbelastbar
- 5 Schubfächer mit Kugelführungen
- Zentralverriegelung mit Zylinderschloss
- Stabiler Schiebegriff
- Lenkrolle, feststellbar
- Entriegelung mit Einhandbedienung
- Kugelgelagerter Vollauszug

Workshop trolley and modules

- Rigid metal construction
- Resisting torsional forces for high loads
- 5 drawers with ball bearings
- Central locking with cylinder lock
- Strong handle
- Steering roller with brake
- Single-handed unlocking
- Fully extendable drawers with ball bearings

Weitere Informationen
zum Produkt siehe Seite 78-90

For further product information
see page 78-90



Werkstattwagen
und Module

Servante d'atelier
et modules

Gereedschapswagens
en modules

5081129

Werkstattwagen, leer

In stabiler Metallkonstruktion, verwindungssteif und hochbelastbar, 5 Schubfächer mit Kugelführungen inkl. großem Staufach für Geräte, Maschinen u.ä.. Zentralverriegelung mit Zylinderschloss

Servante d'atelier, vides

De construction métallique robuste, haute résistance et grande capacité de charge, 5 tiroirs avec glissières à billes y compris grand casier pour outils, machines etc.. Verrouillage central avec serrure à cylindre

Gereedschapswagen,
leeg

Stabiele metalen constructie, torsiebestendig en geschikt voor zware belasting, 5 kogelgelagerde schuifladen, groot opbergvak voor apparaten, machines etc., centrale vergrendeling met cilinderslot

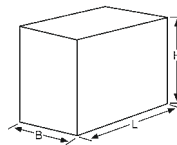

Zubehör siehe gültige HEYCO Preisliste Art.No. 1129-8-1 bis 12
Accessoires, voir Heyco liste de prix actuelle art. no. 1129-8-1 à 12
Toebehoren in HEYCO Prijslijst Art.No. 1129-8-1 tot 12

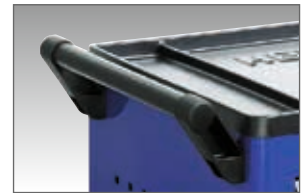
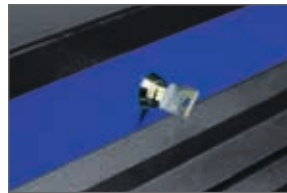

Bestell-No./Order-No.	Art. No.	Maße · Dimensions		
50811290120	5081129	(L) 600 x (B) 440 x (H) 950 mm	54000	1

5081130

Werkstattwagen, leer

In stabiler Metallkonstruktion, verwindungssteif und hochbelastbar, 8 Schubfächer mit Kugelführungen inkl. großem Staufach für Geräte, Maschinen u.ä.. Zentralverriegelung mit Zylinderschloss.

Servante d'atelier, vides

De construction métallique robuste, haute résistance et grande capacité de charge, 8 tiroirs avec glissière à billes y compris grand casier pour outils, machines etc.. Verrouillage central avec serrure à cylindre.

Gereedschapswagen,
leeg

Stabiele metalen constructie, torsiebestendig en geschikt voor zware belasting, 8 kogelgelagerde schuifladen, groot opbergvak voor apparaten, machines etc., centrale vergrendeling met cilinderslot

Zubehör siehe gültige HEYCO Preisliste Art.No. 1129-8-1 bis 12
Accessoires, voir Heyco liste de prix actuelle art. no. 1129-8-1 à 12
Toebehoren in HEYCO Prijslijst Art.No. 1129-8-1 tot 12



Bestell-No./Order-No.	Art. No.	Maße · Dimensions		
50811300120	5081130	(L) 600 x (B) 440 x (H) 950 mm	60000	1

5081129-26

Werkstattwagen mit Modulen

106-tlg. in 2 Modulen

Servante d'atelier avec modules

106 pces. en 2 modules

Gereedschapswagen met modules

106 delig in 2 modules



5081129

Details siehe Seite 83-90
 Presentoirs voir page 83-90
 Details zie pagina 83-90



M 50829-50



M 50829-51

Bestell-No./Order-No.	Art. No.	Module · Modules			
50811292600	5081129-26	M 50829-50	M 50829-51	63210	1

5081129-25

Werkstattwagen mit Modulen

90-tlg. in 5 Modulen

Servante d'atelier avec modules

90 pces. en 5 modules

Gereedschapswagen met modules

90 delig in 5 modules



M 50829-3



M 50829-12



M 50829-13



M 50829-4



M 50829-14

5081129

Details siehe Seite 83-90
 Presentoirs voir page 83-90
 Details zie pagina 83-90

Bestell-No./Order-No.	Art. No.	Module · Modules				
50811292500	5081129-25	M 50829-3	M 50829-4	M 50829-12	64900	1
		M 50829-13	M 50829-14			

5081129-28

Werkstattwagen mit Modulen

100-tlg. in 8 Modulen

Servante d'atelier avec modules

100 pcs. en 8 modules

Gereedschapswagen met modules

100 delig in 8 modules



5081129

Details siehe Seite 83-90
Presentoirs voir page 83-90
Details zie pagina 83-90



M 50829-4



M 50829-5



M 50829-8



M 50829-12



M 50829-13



M 50829-14



M 50829-15



M 50829-16

Bestell-No./Order-No.	Art. No.	Module · Modules			g	
50811292800	5081129-28	M 50829-4	M 50829-5	M 50829-8	66910	1
		M 50829-12	M 50829-13	M 50829-14		
		M 50829-15	M 50829-16			

5081129-27

Werkstattwagen mit Modulen

132-tlg. in 4 Modulen

Servante d'atelier avec modules

132 pcs. en 4 modules

Gereedschapswagen met modules

132 delig in 4 modules



5081129

Details siehe Seite 83-90
Presentoirs voir page 83-90
Details zie pagina 83-90



M 50829-50



M 50829-51



M 50829-54



M 50829-56

Bestell-No./Order-No.	Art. No.	Module · Modules		g	
50811292700	5081129-27	M 50829-50	M 50829-51	69580	1
		M 50829-54	M 50829-56		

5081130-26

Werkstattwagen mit Modulen

106-tlg. in 2 Modulen

Servante d'atelier avec modules

106 pcs. en 2 modules

Gereedschapswagen met modules

106 delig in 2 modules



5081130

Details siehe Seite 83-90
Presentoirs voir page 83-90
Details zie pagina 83-90



M 50829-50



M 50829-51

Bestell-No./Order-No.	Art. No.	Module · Modules			
50811302600	5081130-26	M 50829-50	M 50829-51	63800	1

5081130-27

Werkstattwagen mit Modulen

132-tlg. in 4 Modulen

Servante d'atelier avec modules

132 pcs. en 4 modules

Gereedschapswagen met modules

132 delig in 4 modules



5081130

Details siehe Seite 83-90
Presentoirs voir page 83-90
Details zie pagina 83-90



M 50829-50



M 50829-54



M 50829-51



M 50829-56

Bestell-No./Order-No.	Art. No.	Module · Modules			
50811302700	5081130-27	M 50829-50 M 50829-54	M 50829-51 M 50829-56	70180	1

Werkstattwagen Zubehör

Zubehör siehe gültige HEYCO
Preisliste Art.-No. 1129-8-1 bis 12

Servante d'atelier accessoires

Accessoires, voir Heyco liste de
prix actuelle art. no.
1129-8-1 à 12

Gereedschapswagen Toebehoren

Toebehoren in HEYCO Prijslijst
Art.No. 1129-8-1 tot 12



Papierkorb
Corbeille à papier
Papiermand

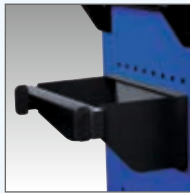

Papirollenhalter
Support de rouleau de
papier
Papierrol houder



Trennblech / Satz
Jeu de lamelles
intercalaires
Verdelerset



Fachteiler / Satz
Jeu de casiers de
rangement
Verdelerset

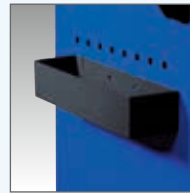

Ablageschale
Boîte de rangement
Opbergvak



Dosenhalter
Support pour aérosols
Bussenhouder

5081129-15

Abdeckhaube für Werkstattwagen

210 D PU Nylon. Preis und
Lieferung ohne Werkstattwagen.



Protection pour Servante d'atelier

nylon 210 D PU. Prix et livraison
sans servante d'atelier.

Afdekhoes voor gereedschapswagen

210 D PU nylon. Prijs en levering
zonder gereedschapswagen



Bestell-No./Order-No.	Art. No.	Maße · Dimensions		
50811291500	5081129-15	(L) 730 x (B) 500 x (H) 850 mm	345	1

1128-8-5

Adapterset / Einlegetrennleisten

für HEYCO Werkstattwagen
1127 + 1128 zur Anpassung an
HEYTEC Schaumstoffmodule, 6-tlg.



Assortiment d'adaptateurs/ sectionneurs

pour servantes d'atelier HEYCO
1127 + 1128, pour l'adaptation
des modules en mousse HEYTEC,
6 pcs.

Adapterset / verdeelschotten

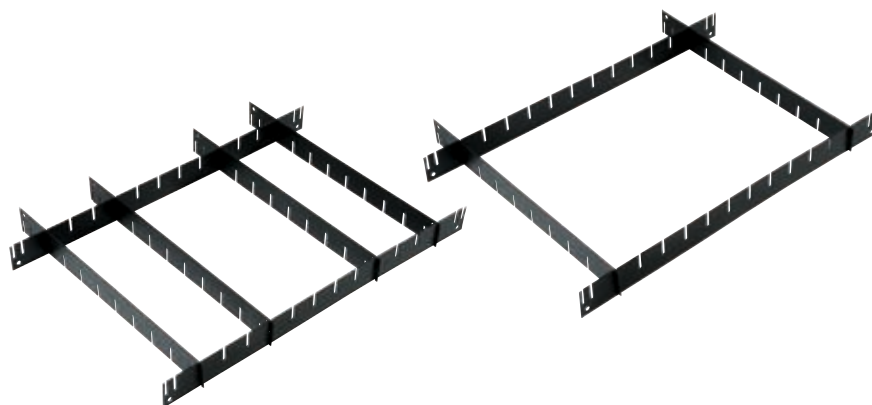
voor Heyco gereedschapswagen
1127 + 1128 voor aanpassing
naar HEYTEC schuimstof modules,
6-dlg



Bestell-No./Order-No.	Art. No.	Maße · Dimensions		
01128110200	1128-8-5	560 x 410 x 45 mm	1410	1

Variable Bestückung der Schubladen im Werkstattwagen HEYTEC 5081129/5081130 mit Modulen
Hochwertiger 2-K Schaumstoff

Equipement des tiroirs de la servante d'atelier HEYTEC 5081129/5081130 avec modules
Garniture 2-K en mousse de haute qualité

Variabele indeling van de schuifladen van de HEYTEC gereedschapswagen 5081129 met modules van Hoogwaardig 2 componenten schuimstof

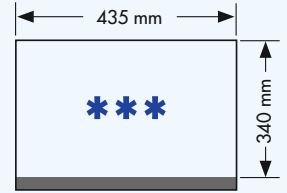
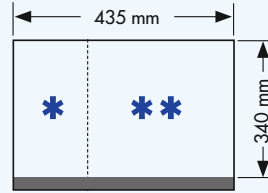
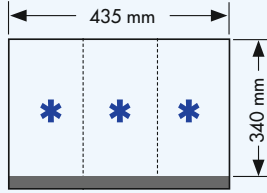

**Modul * *
M 50829-4**



Ringmaulschlüssel-Satz, 17-tlg.
Mit Schonprofil, Doppelmodul

Jeu de clés mixtes, 17 pces.
Avec profil de protection, module double

Ringsteeksleutelset, 17 delig
Met profiel bescherming, dubbele module



enthaltend/containing/composition
 MM 6/7/8/9/10/11/12/13/14/15/16/17/18/19/20/21/22

Bestell-No./Order-No.	Art. No.	Maße · Dimensions		
50829000480	M 50829-4	340 x 290 x 40 mm	4400	1

**Modul * *
M 50829-3**



Doppelmaulschlüssel-Satz, 10-tlg.

Jeu de clés à fourche, 10 pces.

Ringsleutelset, 10 delig



enthaltend/containing/composition
 MM 8x9 / 10x11 / 12x13 / 14x15 / 16x17 / 18x19 / 20x22 / 21x23 / 24x27 / 30x32

Bestell-No./Order-No.	Art. No.	Maße · Dimensions		
50829000380	M 50829-3	340 x 145 x 40 mm	1832	1

**Modul *
M 50829-16**



Doppelringschlüssel-
Satz, 8-tlg.

Tief gekröpft, mit Schonprofil

Clés polygonales
coudées, 8 pces.

Avec profil de protection des têtes
de vis

Ringsleutelset,
8 delig

Diep gebogen, met profiel
bescherming



enthaltend/containing/composition



MM 6x7 / 8x9 /
10x11 / 12x13 /
14x15 / 16x17 /
18x19 / 20x22

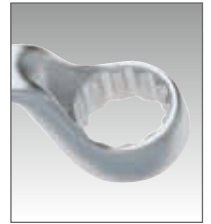

Bestell-No./Order-No.	Art. No.	Maße · Dimensions	g	
50829001680	M 50829-16	340 x 145 x 40 mm	1250	1

**Modul *
M 50829-2**

Knarren-Ringmaul-
schlüssel-Satz
umschaltbar, 13-tlg.

Jeu de clés mixtes à
cliquet réversible,
13 pces.

Ringratelsleutelset
omschakelbaar, 13 delig



enthaltend/containing/composition



MM 8/10/12/13/
14/15/16/17/19/22



1/4" / 3/8" / 1/2"



Bestell-No./Order-No.	Art. No.	Maße · Dimensions	g	
50829000280	M 50829-2	340 x 145 x 40 mm	1536	1

**Modul *
M 50829-9**

Knarren-Ringmaul-
schlüssel-Satz, 13-tlg.

Jeu de clés mixtes à
cliquet, 13 pces.

Ringratelsleutelset,
13 delig



enthaltend/containing/composition



MM 8/9/10/12/13/
14/15/16/17/19



1/4" / 3/8" / 1/2"



Bestell-No./Order-No.	Art. No.	Maße · Dimensions	g	
50829000980	M 50829-9	340 x 145 x 40 mm	1319	1

**Modul *
M 50829-13**



Betätigungswerkzeug-
Satz, 7-tlg.

Jeu d'accessoires,
7 pces.

Hilfstukset,
7 delig



enthaltend/containing/composition



250 mm



250 mm



125 mm



75 mm



MM 16/20,8

Bestell-No./Order-No.	Art. No.	Maße · Dimensions	g	
50829001383	M 50829-13	340 x 145 x 40 mm	1670	1

**Modul *
M 50829-12**



Steckschlüssel-Satz,
20-tlg.

Jeu de douilles,
20 pces.

Dopsleutelset,
20 delig



enthaltend/containing/composition

- 40 mm MM 10/11/12/13/14/15/16/17/18/19/20/21/22/24/27/30/32
- 75 mm MM 13/17/19

Bestell-No./Order-No.	Art. No.	Maße · Dimensions		
50829001283	M 50829-12	340 x 145 x 40 mm	1974	1

**Modul *
M 50829-10**



VDE-Schraubendreher-
Satz mit 2K-Griff, 6-tlg.

Jeu de tournevis VDE
avec poignée à 2
composantes, 6 pces.

VDE schroevendraaierset
met 2 componenten
greep, 6 delig

Nach IEC 60900,
DIN 7437 u. DIN 7438 PZ,
mit umspritzter Klingenisolierung

Conforme aux spécifications
IEC 60900 : DIN 7437 et
DIN 7438 PZ, avec isolation de la
lame par injection

Volgens IEC 60900
DIN 7437 en DIN 7438 PZ,
met klingomspotten isolatie

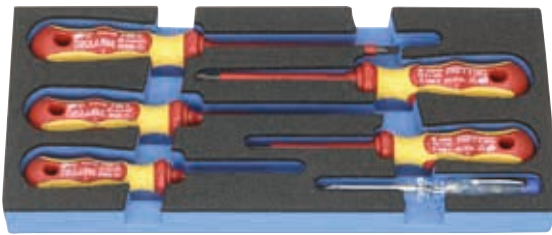

enthaltend/containing/composition

- 150 - 250 V
- MM 2,5x75 / 4x100 / 5,5x125
- PZ 1 / PZ 2

Bestell-No./Order-No.	Art. No.	Maße · Dimensions		
50829001033	M 50829-10	340 x 145 x 40 mm	583	1

**Modul *
M 50829-14**



Steckschlüssel-Satz,
36-tlg.

Jeu de douilles, 36 pces.

Dopsleutelset,
36 delig



enthaltend/containing/composition

- 150 mm
- 150 mm
- 50 + 100 mm
- 37 mm
- 25 mm MM 4/4,5/5/6/7/8/ 9/10/11/12/13
- 50 mm MM 6/7/8/9/10/ 11/12/13
- PZ 1 / PZ 2
- 3/4/5/6
- 0,8x4 / 1x5,5
- TT15 / TT20 / TT25 / TT30

Bestell-No./Order-No.	Art. No.	Maße · Dimensions		
50829001483	M 50829-14	340 x 145 x 40 mm	1025	1

**Modul *
M 50829-17**



Schraubendrehereinsatz
Sortiment, 24-tlg.

Composition de douilles-
tournevis, 24 pces.

Schroevendraaier
dopsleutelset, 24 delig



enthaltend/containing/composition		
CL	62 mm	5/6/7/8/10/12/14/17
CL	62 mm	T 25/27/30/40/45/50/55/60
CL	100 mm	6/8/10/12
CL	100 mm	T 30/40/50/60

Bestell-No./Order-No.	Art. No.	Maße · Dimensions		
50829001783	M 50829-17	340 x 145 x 40 mm	2525	1

**Modul *
M 50829-11**



Radwechsel-Satz, 5-tlg.

Bestehend aus 3 Impact-Einsätzen
mit Kugelfangbohrung, inkl.
Kunststoffhülsen zum Schutz von
Alufelgen, Kunststoffschaber

Jeu pour écrous de roues,
5 pces.

Composé de 3 douilles impact
avec trou pour bille et manchon
plastique de protection des jantes
en aluminium, racloir en plastique

Wielmoersleutelset
5 delig

Bestaande uit 3 krachtdoppen met
kogelvangsleuf, incl. kunststof
hulzen, ter bescherming van
aluminium velgen, kunststof
schrapper



enthaltend/containing/composition		
CL	85 mm	MM 17/19/21
		280 mm
		285 mm

Bestell-No./Order-No.	Art. No.	Maße · Dimensions		
50829001100	M 50829-11	340 x 145 x 40 mm	842	1

**Modul *
M 50829-5**

Zangenmodul mit
Schlosserhammer, 3-tlg.

Pince multiprise et pince-
étau, 3 pces.

Tangenmodule met
bankhamer, 3 delig



enthaltend/containing/composition	
	300 g
	250 mm
	235 mm

Bestell-No./Order-No.	Art. No.	Maße · Dimensions		
50829000500	M 50829-5	340 x 145 x 40 mm	1325	1

**Modul *
M 50829-15**

Zangen-Satz, 3-tlg.

Kombinationszange,
gerade Flachrundzange,
Seitenschneider schwedische
Form, mit Kunststoffhandschutz

Jeu de pinces, 3 pces.

Pince universelle pince à bec
demi-ronds, droite, pince coupante
diagonale modèle suédois, avec
gaine plastique

Zangenset, 3 delig

Combinatietang, telefoontang
recht, zijsnijtang zweeds model,
met kunststof greep

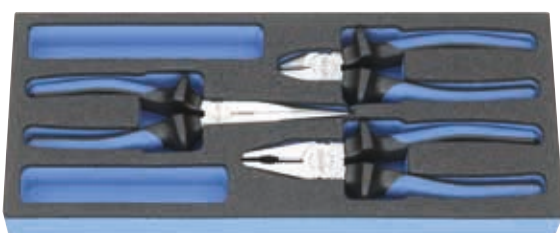

enthaltend/containing/composition	
	180 mm
	200 mm
	160 mm

Bestell-No./Order-No.	Art. No.	Maße · Dimensions		
50829001542	M 50829-15	340 x 145 x 40 mm	715	1

**Modul *
M 50829-8**



Schraubendreher-Satz
mit 2K-Griff, 6-tlg.

Jeu de tournevis
avec poignée à 2
composantes, 6 pcs.

Schroevendraaierset met
2 componenten greep,
6 delig

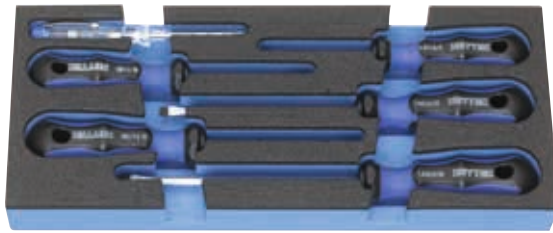

enthaltend/containing/composition

	150 - 250 V
	MM 4x75 / 5,5x125 / 6,5x150
	PH 1 / PH 2

Bestell-No./Order-No.	Art. No.	Maße · Dimensions		
50829000880	M 50829-8	340 x 145 x 40 mm	553	1

**Modul *
M 50829-19**



VDE-Zangen-Satz, 3-tlg.

Jeu de pinces VDE,
3 pcs.

VDE tangenset,
3 delig

Köpfe geschliffen und lackiert,
Griffe mit 2-K Isoliergriffen
IEC 900/DIN EN 60900,
Schneide für mittelharten Draht

Chromées et laquées branches
gainées isolées à 2 composantes
IEC 900/DIN EN 60900,
pour fil de dureté moyenne

Kop gepolijst en gelakt, grepen
met 2 componenten isolatiegreep
IEC 900/DIN EN 60900,
knipt middelharde draad



enthaltend/containing/composition

	180 mm
	200 mm
	160 mm

Bestell-No./Order-No.	Art. No.	Maße · Dimensions		
50829001986	M 50829-19	340 x 145 x 40 mm	710	1

Modul *
M 50829-18**



VDE-Werkzeugsortiment,
12-tlg.

Sélection d'outillage
VDE, 12 pcs.

VDE schroevendraaierset,
12 delig

In 2-K Schaumstoffeinlage.
Nach IEC 60900,
DIN 7437 u. DIN 7438 PZ.

Avec intérieur mousse à 2
composantes. Conforme aux
spécifications IEC 60900 : DIN
7437 et DIN 7438 PZ.

Met 2 componenten greep.
Volgens IEC 60900
DIN 7437 en DIN 7438 PZ.

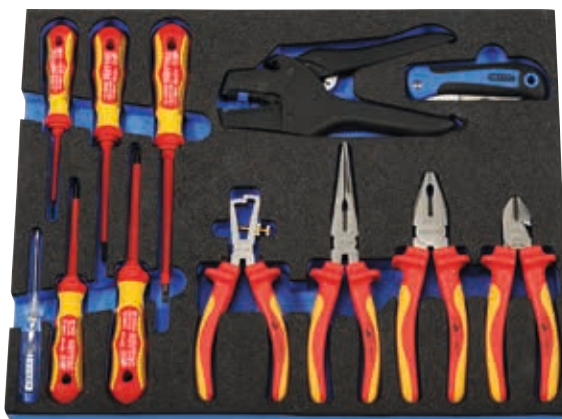

enthaltend/containing/composition

	180 mm
	160 mm
	200 mm
	160 mm
	200 mm
	115 - 195 mm
	150 - 250 V
	MM 0,5 x 2,5 x 75 / 0,8 x 4,0 x 100 / 1,0 x 5,5 x 125
	PZ 1 / PZ 2

Bestell-No./Order-No.	Art. No.	Maße · Dimensions		
50829001800	M 50829-18	435 x 340 x 35 mm	2910	1

Modul *
M 50829-52**

Schraubendrehereinsatz
Sortiment, 48-tlg. | Composition de douilles-
tournevis, 48 pcs.

Schroevendraaier
dopsleutelset, 48 delig



enthaltend/containing/composition		
	CL 62 mm	5/6/7/8/10/12/14/17
	CL 100 mm	6/8/10/12/14
	CL 62 mm	M5 / M6 / M8 / M10
	CL 62 mm	T 20/25/27/30/40/45/50/55/60
	CL 100 mm	M 6/8/10/12
	CL 100 mm	T 30/40/50/60
	CL 38 mm	E 10/11/12/14/16/18/20/22/24
	CL 62 mm	M5 / M6 / M8 / M10 / M12

Bestell-No./Order-No.	Art. No.	Maße · Dimensions		
50829005200	M 50829-52	435 x 340 x 35 mm	4630	1

Modul *
M 50829-53**

Steckschlüssel-Satz,
17-tlg. | Jeu de douilles, 17 pcs.

Dopsleutelset,
17 delig



enthaltend/containing/composition		
		510 mm
		455 mm
		3/4" - 1/2"
		100 + 200 + 400 mm
	CL 40 mm	MM 19/22/24/27/30/32/36
		HW 14/17/19/22

Bestell-No./Order-No.	Art. No.	Maße · Dimensions		
50829005300	M 50829-53	435 x 340 x 35 mm	8800	1

Modul *
M 50829-54**

Zangen-Satz, 10-tlg. | Jeu de pinces, 10 pcs.

Zangenset, 10 delig



enthaltend/containing/composition		
		250 mm
		230 mm
		260 mm
		235 mm
		200 mm
		180 mm
		200 mm
		160 mm
		Gr. 18 mm inkl. Ersatzklingen / incl. Spare blades

Bestell-No./Order-No.	Art. No.	Maße · Dimensions		
50829005400	M 50829-54	435 x 340 x 35 mm	2870	1

Modul *
M 50829-55**

Schraubendreher-Satz mit 2K-Griff, 35-tlg.

Jeu de tournevis avec poignée à 2 composantes, 35 pces.

Schroevendraaierset met 2 componenten greep, 35 delig



enthaltend/containing/composition

	150 - 250 V
	MM 4x75 / 5,5x125 / 6,5x150
	PH 1 / PH 2
	T 15/20/25/27/30/40
	MM 8/6/5/4/3
	T 10/15/20/25/27
	30/40/45/50
	MM 1,5/2/2,5/3/4/5/6/8/10

Bestell-No./Order-No.	Art. No.	Maße · Dimensions		
50829005500	M 50829-55	435 x 340 x 35 mm	1800	1

Modul *
M 50829-56**

Kombinierter Werkzeug-Satz, 16-tlg.

Ensemble d'outils combinés, 16 pces.

Gecombineerde gereedschapset, 16 delig



enthaltend/containing/composition

	1000 g
	300 g
	Ø 35
	200 mm
	Ø 3 x 120 mm
	Ø 5 x 150 mm
	Ø 3 x 120 mm
	5 x 130 mm
	12 x 130 mm
	14 x 150 mm

Bestell-No./Order-No.	Art. No.	Maße · Dimensions		
50829005600	M 50829-56	435 x 340 x 35 mm	3500	1

Modul *
M 50829-57**

Werkzeug-Satz „KFZ“, 17-tlg.

Ensemble d'outils "KFZ", 17 pces.

Gereedschapset "KFZ", 17 delig



enthaltend/containing/composition

	CL 85 mm	MM 17/19/21
	CL 150 mm	MM 17/19/21
	280 mm	
	400 mm	
	290 mm	
	CL 75 mm	MM 16/20,8
	84 mm	0-60 mm
	260 mm	
	40 - 200 Nm	

Bestell-No./Order-No.	Art. No.	Maße · Dimensions		
50829005700	M 50829-57	435 x 340 x 35 mm	4200	1

50868-1**FORESTMAN**

- 1 Paar Arbeitshandschuhe
- 1 Autolichtprüfer 6 - 24 V
- 1 Sicherheits-Rettungsmesser, Länge 200 mm
- 1 LED-Solar-Stablampe, Länge 180 mm
- 1 Profi-Bandmass, 5 m
- 1 Puk-Handsäge mit 2 Sägeblättern
- 1 Rolle Isolierband, Textilgewebe
- 1 Gartenschere
- 1 20-tlg. Nagelsortiment 4,6 x 130 mm / 3,1 x 65 mm
- 1 Leere Kunststoffbox (für Kleinteile)
- 1 Spannungsprüfer 250 V
- 1 Latthammer, Vollstahl 600 gr.
- 1 Sicherheits-Klappsäge
- 1 Pollerschlüssel, 3-kt, M10 x M12, DIN 3222/3223
- 1 Stirnleuchte mit Batterien

- 1 Paire de gants de travail
- 1 Contrôleur de tension 6 - 24 V.
- 1 Coûteau de survie de sécurité, L 200 mm
- 1 Lampe de poche solaire à LED, L 180 mm
- 1 Mètre-ruban professionnel, 5 M
- 1 Mini-scie à découper et 2 lames
- 1 Rouleau de bande isolante en toile textile
- 1 Sécateur de jardin
- 1 Assortiment de clous, 20 pces. (4,6 x 130 mm / 3,1 x 65 mm)
- 1 Boîte plastique vide (pour petites pièces)
- 1 Tournevis détecteur de tension 250 V.
- 1 Marteau de charpentier 600 gr.
- 1 Scie de sécurité repliable
- 1 Clé en tube triangulaire, M10 x M12, DIN 3222/3223
- 1 Lampe à tête avec piles

- 1 Paar wekhandschoenen
- 1 Auto spanningzoeker 6 - 24 V
- 1 Reddingsmes, lengte 200 mm
- 1 LED solar zaklantaarn, lengte 180 mm
- 1 Professionele rolbandmaat, 5 m
- 1 Ijzerzaag met 2 zaagblaadjes
- 1 Rol isolatietape, textiel geweven
- 1 Snoeischaar
- 1 20 delige spijkerset 4,6 x 130 mm / 3,1 x 65 mm
- 1 Lege kunststof box (voor kleine onderdelen)
- 1 Spanningzoeker 250 V
- 1 Lattenhamer, geheel staal, 600 gr.
- 1 Veiligheids snoeizaag
- 1 Paalsleutel, 3 kant, M 10 x M 12, DIN 3222/3223
- 1 Hoofd lamp met batterijen

**50868-2****FORESTMAN**

- 1 Zündkerzenschlüssel 13 x 19 für fast alle Motorsägen und -geräte
- 1 Handbeil 600 gr.
- 1 Rohr- und Wasserpumpenzange 240 mm
- 1 Steinmeißel 300 x 18 mm
- 1 Monier- und Rabitzzange 220 mm, isoliert
- 7-tlg. Winkelschraubendreher-Satz, 6-kt, 1,5 - 6 mm
- 7-tlg. Winkelschraubendreher-Satz, TORX, T10 - T40
- 1 Fäustel, Fiberglasstiel, 1.000 gr.
- 1 Einmaulschlüssel, verstellbar 0-25 mm

- 1 Clé de bougie, presque toutes les outils à moteur thermique
- 1 Hachette 600 gr.
- 1 Pince multiprise 240 mm
- 1 Burin à pierre 300 x 18 mm
- 1 Tenaille russe
- Jeu de clés mâles coudées 6-pans
- 7 pces, 1,5 - 6 mm
- Jeu de clés mâles coudées TORX,
- 7 pces, T10 - T40
- 1 Masse, mache en fibre, 1000 gr.
- 1 Clé à molette, réglable 0-25 mm

- 1 Bougiesleutel 13 x 19 voor bijna alle motorzagen en -apparaten
- 1 Handbijl 600 gr.
- 1 Waterpomptang 240 mm
- 1 koudbeitel 300 x 18 mm
- 1 Moniertang 220 mm, geïsoleerd
- 7 Delige stiftsleutelset, 6 Kant, 1,5 - 6 mm
- 7 Delige stiftsleutelset, TORX®, T10 - T40
- 1 Vuisthamer, glasfiber steel, 1000 gr.
- 1 Verstelbare moersleutel, 0-25 mm

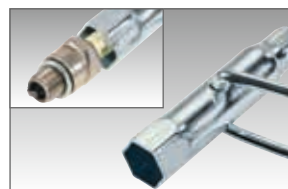

50868-3

FORESTMAN



- 1 Nageleisen
- 1 Steckschlüsselgarnitur 1/4", 22-tlg. MM 5 – 13
- 1 Bit-Box-Satz, 32-tlg.
- 1 Akkuschauber
- 1 Bohrsatz, MM 1–6
- 1 Kabelbinder-Satz 203 x 4,6 mm, 20-tlg.
- 1 Klappspaten, 3-fach verstellbar

Steckschlüsselgarnitur 1/4", 22-tlg.
(Art.-Nr. 50829-3017 Seite 42)
Arretierbare Winkelnarre, Steckschlüssel MM 5 – 13, magnetischer Schnellwechseladapter, Steckgriff, Verlängerung, Schraubendrehereinsätze Schlitz, Kreuzschlitz, TORX®

Akkuschauber-Set
3,6 V/1,3 Ah Li-ion Akku, max. Drehmoment 5 Nm, R+L-Lauf, Ladezeit: 300 min., in einer Polyestertasche mit Reißverschluss, inklusive Ladegerät 220 V und KFZ 12 V

- 1 Pince à décoffrer
- 1 Composition de douilles 1/4", MM 5 – 13, 22 pces.
- 1 Jeu d'embouts de 32 pces.
- 1 Tournevis sans fil
- 1 Jeu de forets, MM 1–6
- 1 Jeu de 20 attache-câbles 203 x 4,6 mm
- 1 Pelle pliable à 3 positions

Composition de douilles 1/4", 22 pces.
(art.-no. 50829-3017 page 42)
Cliquet angulaire blocable sur 5 positions, douilles MM 5 – 13 adaptateur, magnétique à changement rapide poignée d'entraînement, rallonge douilles-tournevis plat, en croix et TORX®

Jeu de visseuse sur batterie
Batterie de 3,6 V/1,3 Ah Li-ion, couple maximum 5 Nm, visser + dévisser, temps de charge: 300 min., dans un sachet polyester avec fermeture-éclair, y compris le chargeur 220 V et la voiture 12 V

- 1 Breekijzer
- 1 Dopsleutelset 1/4", 22 delig 5 – 13 mm
- 1 Accu schroefmachine set, 20 delig
- 1 Kabelbundelbandjes set, 20 delig
- 1 Pioniersschop, inklapbaar, 3-voudig verstelbaar

Dopsleutelset 1/4", 22 delig
(Art.nr. 50829-3017, pagina 30)
Knikbare ratel, dopsleutels 5 – 13 mm, magnetische snelwisseladapter schroevendraaiergreep, verlengstuk, schroevendraaier dopsleutels sleuf, Philips en TORX®

Accu schroefmachine set
3,6 V/1,3 Ah Li-ion accu, max. koppel 5 Nm, R-L omschakelbaar, Laadtijd: 300 minuten, met 7 delige bitset en 10 delige metaalborenset 1-6 mm in een polyestertas met klittebandsluiting. Incl. lader 220 V en autolaadsnoer 12 V

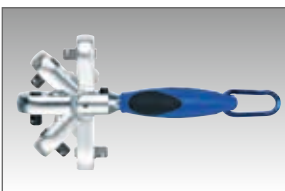

Bestell-No./Order-No.	Art. No.	Maße · Dimensions		
5086800000	50868	550 x 360 x 240 mm	15100	1



Sonderwerkzeug- und Prototypenbau

Wenn spezielle Anwendungen besondere Werkzeuge oder Werkzeugsortimente erfordern, sind wir Ihr kompetenter Ansprechpartner. Diesen Herausforderungen stellen wir uns und realisieren ökonomisch sinnvolle Werkzeuge und Werkzeugsortimente, technische Lösungen von der Idee bis zur Serienfertigung.

Mit unseren Sortimenten erfüllen wir nicht nur den allgemeinen Werkstattbedarf, sondern sind auch der Spezialist für verlässliche Sortimente im Rettungswesen und in der Flugsicherheit, sowie im Straßenbau und in der Agrartechnik.

Die Verfügbarkeit aller bedeutenden Fertigungsverfahren versetzt uns in die Lage, Ihre Ansprüche und Ideen konsequent und zu Ihrer vollsten Zufriedenheit umzusetzen.

Specialised tools and prototyping

We are the professional partner you need at your side whenever special applications require specialised tools or tool sets. We take on these challenges and realise practical and cost-effective tools, tool portfolios and technical solutions from the initial idea to serial production.

With our portfolios, we cater not only for general workshop needs, we are also specialists for ranges of reliable tools for rescue services and flight safety, as well as for road construction and agricultural equipment.

Our ability to draw on all important manufacturing methods enables us to realise your ideas and requirements to your complete satisfaction in every respect.





SONDERWERKZEUG- UND PROTOTYPENBAU SPECIALISED TOOLS AND PROTOTYPING

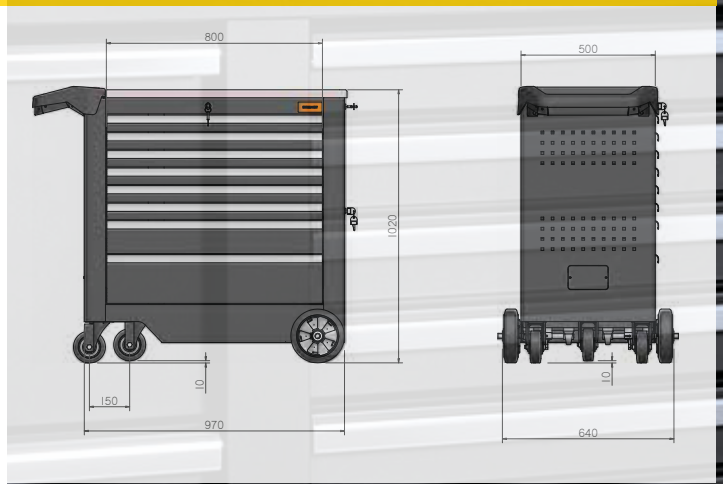

50881-6

Werkzeugkasten
„JUNIOR“

mit Sortiment, 28-tlg.
Stahlblech, lackiert

Boîte à outils
„JUNIOR“

avec assortiment d'outils 28 pcs.
en tôle d'acier, peint

Gereedschapskist
„JUNIOR“

met assortiment, 28-delig.
Plaatstaal, gelakt.



enthaltend/containing/composition

	MM 6x7/ 8x9 / 10x11 / 12x13 / 14x15 / 16x17 / 18x19 / 20x22
	MM 4,0 x 75 / 5,5 x 125 / 6,5 x 150
	PH 1 / 2
	150 - 250 V
	160 mm
	230 mm
	250 mm
	500 g
	200 mm
	200 mm
	MM 1,5/2/2,5/3/4/5/6/8/10
	TX 10/15/20/25/27/30/40/45/50
	155 mm / 6" Nonius 1/20 mm / 1/128"
	Gr. 18 mm
	3 m
	230 mm
	CE/EN 388-4131

Bestell-No./Order-No.	Art. No.	Maße · Dimensions		
50881000600	50881-6	430 x 185 x 200 mm	8400	1

98076-08

Montage-
Werkzeugkasten, leer

5-tlg. Stahlblech,
in Hammerschlagblau

Boîte à outils, vides

5 compartiments, en tôle d'acier
couleur bleu martelé

Gereedschapskist,
leeg

5 delig plaatstaal,
in blauw hamerslag lak



Bestell-No./Order-No.	Art. No.	Maße · Dimensions		
98076080020	98076-08	530 x 200 x 200 mm	3250	1

508076-945

Montage-Werkzeug-
kasten mit Modulen

5 Module, 96-tlg.

Boîte à outils
avec modules

5 Modules, 96 pcs.

Gereedschapskist
met modules

5 Modules, 96 delig

Heimwerker
4/10 Praxis Oberklasse
TESTSIEGER

Vertrieb: Heyco, Flemscheid
Preis: um 290
Hotline: 02191 2050
Internet: www.heyco.de

Note:

Schraubendreher:	15%	1,4	●●●●●
Schraubenschlüssel:	15%	1,1	●●●●●
Flatschen-/Bitsätze:	25%	1,5	●●●●●
Zangen:	15%	1,2	●●●●●
Bedienung (Set):	10%	1,4	●●●●●
Ausstattung:	20%	1,0	●●●●●

Bewertung: ●●●

● keine losen Teile / Austreiber
● Gewicht

Oberklasse

Heimwerker
Praxis 4/2010

1,3

Preis/Leistung: gut



M 50829-30

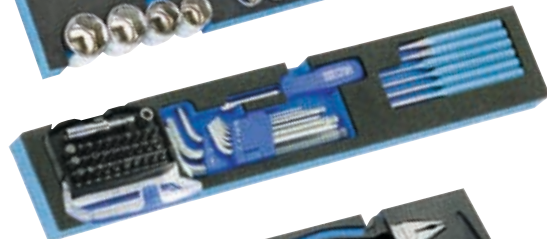

M 50829-31



M 50829-32



M 50829-33



M 50829-34



Bestell-No./Order-No.	Art. No.	Module · Modules			⚖	📦
50807694500	508076-945	M 50829-30	M 50829-31	M 50829-32	14430	1
		M 50829-33	M 50829-34			

enthaltend · containing · composition



M 50829-30



Werkzeugmodul,
21-tlg.

Module avec outils,
21 pces.

Gereedschapsmodul,
21 delig

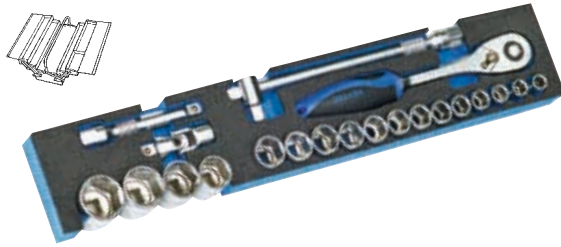

enthaltend/containing/composition	
	250 mm
	250 mm
	125 mm
	MM 10/11/12/13/14/15/16/17/18/19/ 20/21/22/24/27/30/32
	75 mm

Bestell-No./Order-No.	Art. No.	Module · Modules		
50829003083	M 50829-30	528 x 98 x 35 mm	2954	1

M 50829-31

Werkzeugmodul,
48-tlg.

Module avec outils,
48 pces.

Gereedschapsmodul,
48 delig



enthaltend/containing/composition	
	Ø 3 x 120 mm
	Ø 3 x 150 mm / Ø 4 x 150 mm / Ø 5 x 150 mm / Ø 6 x 150 mm
	Ø 4 x 120 mm
	MM 1,5/2/2,5/3/4/5/6/8/10
	150 mm
	50833-2 (siehe Seite 36/see page 36/ voir page 36)

Bestell-No./Order-No.	Art. No.	Module · Modules		
50829003100	M 50829-31	528 x 98 x 35 mm	1063	1

M 50829-32

Werkzeugmodul,
7-tlg.

Module avec outils,
7 pces.

Gereedschapsmodul,
7 delig



enthaltend/containing/composition	
	1000 g
	300 g
	195 – 570 mm
	180 mm
	250 mm
	160 mm
	255 mm

Bestell-No./Order-No.	Art. No.	Module · Modules		
50829003200	M 50829-32	528 x 195 x 35 mm	3040	1

M 50829-33

 Werkzeugmodul,
6-tlg.

 Module avec outils,
6 pces.

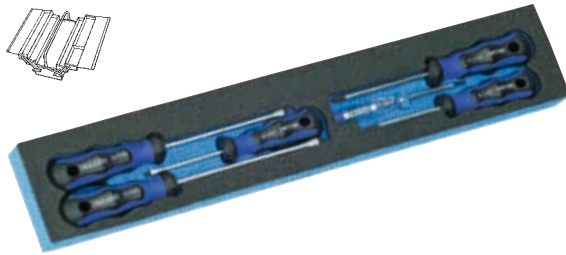
 Gereedschapsmodul,
6 delig

enthaltend/containing/composition

- 0,75 x 3,0 x 60 mm
- 4,0 x 75 mm
- 5,5 x 125 mm
- 6,5 x 150 mm
- PH 1 / PH 2

Bestell-No./Order-No.	Art. No.	Module · Modules		
50829003380	M 50829-33	528 x 98 x 35 mm	483	1

M 50829-34

 Werkzeugmodul,
14-tlg.

 Module avec outils,
14 pces.

 Gereedschapsmodul,
14 delig

enthaltend/containing/composition

- MM 8/10/11/12/13/14/15/
16/17/19/22/24
- 170 mm
- 5 m

Bestell-No./Order-No.	Art. No.	Module · Modules		
50829003480	M 50829-34	528 x 98 x 35 mm	1888	1

M 50829-35

 Austauschmodul
für Montage-Werkzeug-
kasten, 16-tlg.

 Module alternatif pour
boîte à outils pour
monteurs, 16 pces.

 Extra module voor mant-
ge gereedschapskist,
16 delig

enthaltend/containing/composition

- MM 6x7/8x9/10x11/12x13/
14x15/16x17/18x19/20x22
- MM 6x7/8x9/10x11/12x13/
14x15/16x17/18x19/20x22

Bestell-No./Order-No.	Art. No.	Module · Modules		
50829003580	M 50829-35	528 x 98 x 35 mm	1960	1

Montage-Werkzeug-sortiment, 97-tlg.

L-BOXX® Module mit 97 Werkzeugen

- Ordentlich Aufbewahren
- Einfache Klickverbindung
- Modularer Innenraum
- Einzigartiges Mobilitätssystem
- Beliebig erweiterbar
- Crashesicherer Transport
- Aus schlag- und stoßfestem ABS-Kunststoff
- Ergonomisch geformten Griffe, zusätzliche seitliche Griffschalen garantieren ein flexibles und komfortables Handling
- Der Deckel ist bis 100 kg belastbar, spritzwassergeschützt
- Beladungskapazität pro Box bis zu 25 kg
- Transport der Boxen im Verbund bis 40 kg

Assortiment d'outils d'assemblage, 97 pcs.

Module L-BOXX® avec 97 outils

- Ranger proprement
- Connexion facile par simple clic
- Intérieur modulaire
- Système de mobilité unique
- Extensible si nécessaire
- Transport anti-crash
- Fabriqué en plastique ABS résistant aux chocs et aux impacts
- Poignées de formes ergonomique. Poignées latérales supplémentaires ainsi que des boucles pratiques qui garantissent une flexibilité et manipulation confortable
- Le couvercle peut tenir 100 kg et est résistant aux éclaboussures
- Capacité de chargement par boîte jusqu'à 25 kg
- Transport des boîtes en combinaison jusqu'à 40 kg



Montage gereedschapset, 97-dlg.

L-BOXX® module met 97 stuks gereedschap

- Overzichtelijk bewaren
- Eenvoudig klik-mechanisme
- Modulaire indeling
- Uniek mobiliteitssysteem
- Naar wens uitbreidbaar
- Crashbestendig transport
- Van slag-en stootvast ABS
- Ergonomisch gevormde grepen, met extra zijgrepen en praktische lussen voor flexibele en comfortabele handling
- Deksel tot 100kg belastbaar, spatwaterdicht
- Koffer belastbaar tot 25 kg
- Bij gekoppelde koffers belastbaar tot 40 kg

new



Bestell-No./Order-No.	Art. No.	Maße · Dimensions	Module · Modules		
new 50820176200	508201-762	442 x 357 x 151 mm	50807696100 50807696200	11690	1



50876-961

Montage-Werkzeug-
sortiment für L-BOXX®,
77-tlg.

Assortiment d'outils
d'assemblage pour
L-BOXX®, 77 pcs.

Montage gereedschapset
voor L-BOXX®,
77-dlg.



Bestell-No./Order-No.

Art. No.

Maße · Dimensions



new

50807696100

50876-961

405 x 310 x 50 mm

5910

1

enthaltend/containing/composition

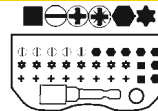

50833-2
(siehe Seite 36/see page 36/
voir page 36/véase página 36)



255 mm



250 mm



250 mm



75 mm



MM 1,5/2/2,5/3/4/5/6/8/10



200 mm



MM 8/10/11/12/13/14/
15/16/17/19/22/24



MM 10/11/12/13/14/15/16/17/
18/19/20/21/22/24/27/30/32



125 mm



230 mm

50876-962

Montage-Werkzeug-
sortiment für L-BOXX®,
20-tlg.

Assortiment d'outils
d'assemblage pour
L-BOXX®, 20 pcs.

Montage gereedschapset
voor L-BOXX®,
20-dlg.



Bestell-No./Order-No.

Art. No.

Maße · Dimensions



new

50807696200

50876-962

405 x 310 x 40 mm

5110

1

enthaltend/containing/composition



150 - 250 V



0,8 x 4,0 x 75 mm / 1,0 x 5,5 x 125 mm /
1,2 x 6,5 x 150 mm



PH 1 / PH 2



3 m



Gr. 18 mm



1000 g



300 g



250 mm



180 mm



160 mm



195 - 570 mm

508675



Montage-Werkzeugkoffer mit Modulen, 134-tlg.

Hochwertiger ABS-Schalenkoffer mit Werkzeugtafeln und 2-K Schaumstoffeinlage (4 Module)

- Ausstattungsmerkmale:
- Made in Germany
 - Schlagfestes ABS-Material
 - Umlaufender Stoßkantenschutz
 - Hochwertige Metallschlösser
 - Stabiler und gehärteter Aluminiumrahmen
 - Ergonomischer Tragegriff
 - Drei Metallscharniere
 - Stabiler Deckelhalter
 - Getestet im Dauereinsatz bis 25 kg

Coffre à outils avec modules, 134 pcs.

Boîtier ABS de haute qualité avec plateau d'outils et deux inserts en mousse 2 composants (4 Modules)

- Caractéristiques:
- Fabriqué en Allemagne
 - Matériel ABS haute résistance
 - Pare-chocs autour du coffret
 - Serrures métalliques de haute qualité
 - Cadre en aluminium stable et dur
 - Poignée ergonomique
 - Trois charnières métalliques
 - Support à couvercle robuste
 - Testé en utilisation continue jusqu'à 25 kg

Montage gereedschapskoffer met modules, 134 delig

Hoogwaardige ABS koffer met gereedschapbladenen 2 componenten schuimstofinleg (4 Modules)

- Uitgerust met:
- Made in Germany
 - Slagvast ABS
 - rondom uitgevoerd met beschermerand
 - hoogwaardige metalen sloten
 - robuust en gehard aluminium frame
 - ergonomische greep
 - drie metalen scharnieren
 - robuuste dekselscharnieren
 - getest tot 25 kg



32-tlg./pcs.



25-tlg./pcs.



enthaltend/containing/composition	
	MM 8/10/11/12/13/14/15/16/17/19/22/24
	Geprüft nach DIN EN 166 F
	9" / CE/EN 388-4131
	150 - 250 V
	Gr. 18 mm
	195 - 570 mm
	MM 4,0 x 75 / 5,5 x 125 / 6,5 x 150
	PH 1 / 2
	200 mm
	200 mm
	250 mm
	180 mm
	160 mm
	MM 1,5/2/2,5/3/4/5/6/8/10
	TX 10/15/20/25/27/30/40/45/50
	205 mm
	3 m
	200 mm
	500 g
	230 mm
	200 mm
	200 mm
	250 mm
	250 mm
	125 mm
	MM 10/11/12/13/14/15/16/17/18/19/20/21/22/24/27/30/32
	75 mm
	115 mm
	100 mm
	125 mm
	TT 10-40
	PH2
	5/6
	PZ 2
	MM 4/4,5/5/5,5/6/7/8/9/10/11/12/13
	Ø 3 x 120 mm
	5 x 130 mm
	Ø 5 x 150 mm
	12 x 130 mm
	Ø 3 x 120 mm
	14 x 150 mm

Bestell-No./Order-No.	Art. No.	Maße · Dimensions		
5086750000	508675	460 x 370 x 170 mm	13300	1

50807-92



Montage-Werkzeug-sortiment in Umhänge-tasche, 92-tlg.

Hochwertige Aufbewahrungstasche mit Klemmhaltesystem sowie Einsteckfächern für Werkzeuge aller Art

Ausstattungsmerkmale:

- Gepolsterter Trageriemen
- Robuster Tragegriff
- Ausklappbarer Stellfuß für sicheren Stand
- Kleinteilmagazin
- Geschütztes, gepolstertes Laptop-Fach
- Zusätzliches Fach für Dokumente

Sélection de outillage en sac pour outils, 92 pcs.

Sac de rangement de haute qualité avec système de serrage, ainsi que des poches pour tous types d'outils

Caractéristiques:

- Bandoulière rembourrée
- Poignée de transport robuste
- Pli pied réglable pour plus de stabilité
- Pour petites pièces
- Protégé, compartiment rembourré pour ordinateur portable
- Compartiments à documents

Gereedschapstas, 92 delig

Hoogwaardige gereedschapstas met gereedschapsklemmen en insteekvakken voor allerhande gereedschappen

Uitgerust met:

- Gepolsterde draagriem
- Robuuste draaggreep
- Uitklapbare stelvoet
- Vakkendoos voor kleine materialen
- Beschermd, gepolsterd laptopvak
- Extra vak voor documenten



enthaltend/containing/composition

- 5 m
- 250 mm
- MM 8/9/10/11/13/14/17/19
- 180 mm
- 160 mm
- MM 1,5/2/2,5/3/4/5/6/8/10
- 150 - 250 V
- 300 g
- 150 mm
- 150 mm, Stahl, 10 Stk./pcs.
- Gr. 18 mm
- 195 - 570 mm
- Geprüft nach DIN EN 166 F
- 230 mm
- MM 4,0 x 75 / 5,5 x 125 / 6,5 x 150
- PH 1 / 2
- 150 mm
- R1 - R2
- 3,5 - 8
- 2 - 8
- PH 1 - 3
- PZ 1 - 3
- TT 9 - 40
- 205 mm
- 250 mm
- 125 mm
- MM 8/10/11/13/15/17/18/19/22/24
- MM 20,8

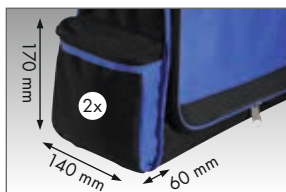
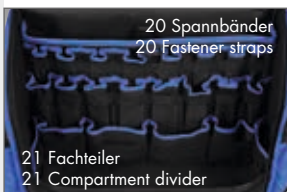

Bestell-No./Order-No.	Art. No.	Maße · Dimensions		
50807892000	50807-92	555 x 410 x 180 mm	9500	1

Rucksack für Werkzeugsortimente, leer

Hochwertiger Rucksack mit separater Innentasche für Werkzeuge aller Art

Ausstattungsmerkmale:

- Robuster Tragegriff
- Zusätzlicher Deckel zum Schutz vor Nässe
- Rutschfeste, gummierte Bodenplatte
- Sicherheitsreflektoren, robuste Aufhängeösen
- Rückenbereich ergonomisch gepolstert
- Gepolsterte Schultergurte mit Handytasche
- Netz-Außentaschen
- Seitentasche mit Fach für Visitenkarten
- Elastische Halteriemien
- Separate Werkzeugtasche
- Viele Einsteck- und Klemmhaltermöglichkeiten
- Innenfächer für Schreibunterlagen/Laptop/Tablet
- Robuste und stabile Bauform mit vielen Extras
- Hoher Tragekomfort, ergonomische Form

Sac à dos vide pour assortiment d'outillage

Sac à dos de haute qualité avec poche intérieure séparée pour toutes sortes d'outils

Caractéristiques:

- Poignée robuste
- Couverture supplémentaire protection contre l'humidité
- Semelle caoutchoutée anti-dérapant
- Réflecteurs de sécurité, crochets de suspension robustes
- Rembourrage ergonomique
- Centures d'épaule rembourrées avec poche pour téléphone cellulaire
- Poches extérieures devant et sur un côté
- Poche latérale pour cartes de visite
- Bandoulières élastiques
- Sac à outils séparé pour enlèvement facile
- Plusieurs compartiments de stockage et de verouillage
- Compartiments intérieurs pour ordinateur portable/tablette PC
- Design robuste avec de nombreux extras
- Confort excellent et forme ergonomique

Rugzak voor gereedschapsets, leeg

Hoogwaardige rugzak met apart binnenvak voor diverse gereedschappen

Kenmerken:

- Robuust handvat
- Extra waterafstotende afdekflap
- Rubberen anti-slip bodemplaat
- Veiligheidsreflectoren, robuuste ophangogen
- Ergonomische, gepolsterde rugzijde
- Gepolsterde schouderbanden met gsm-vakje
- Gaas-vakken aan de buitenkant
- Zijvak met ruimte voor visitekaartjes
- Elastische sluitriemen
- Aparte gereedschaptas
- Veel insteek- en klemmogelijkheden
- Binnenvakken voor schrijfbodigheden/laptop/tablet
- Robuust ontwerp met vele extra's
- Uitstekend draagcomfort, ergonomische vorm



Bestell-No./Order-No.

Art. No.

Maße · Dimensions



50810520000

5081052

460 x 350 x 180 mm

2500

1

5081052-9



Montage-Werkzeug-sortiment im Rucksack, 92-tlg.

Hochwertiger Rucksack mit separater Innentasche für Werkzeuge aller Art

Assortiment d'outils en sac à dos, 92 pces.

Sac à dos de haute qualité avec poche intérieure séparée pour toute sortes d'outils

Montage gereedschapset in rugzak, 92-dlg.

Hoogwaardige rugzak met apart binnenvak voor diverse gereedschappen



YouTube



enthaltend/containing/composition

	5 m	
	250 mm	
	180 mm	
	180 mm	
	150 - 250 V	
	300 g	
	150 mm	
	10 Stk./pcs.	
	Gr. 18 mm	
	195 - 570 mm	
	230 mm	
	205 mm	
	250 mm	
	MM 8/9/10/11/ 13/14/17/19	
	MM 1,5/2/2,5/ 3/4/5/6/8/10	
	Gepüft nach DIN EN 166 F	
	MM 4,0 x 75 / 5,5 x 125 / 6,5 x 150	
	PH 1 / 2	
	150 mm	
	■ R1 - R2 ● 2 - 8	PH1 - 3 PZ 1 - 3 TT 9 - 40
	125 mm	
	MM 8/10/11/13/ 15/17/18/19/22/24	
	MM 20,8	

Bestell-No./Order-No.

50810529200

Art. No.

5081052-9

Maße · Dimensions

460 x 350 x 180 mm



10600



1

5081052-5

Dachdecker-Sortiment
im Rucksack,
50-tlg.

Hochwertiger Rucksack
mit separater Innentasche
für Werkzeuge aller Art

Assortiment pour couvreur
dans sac à dos,
50 pces.

Sac à dos de haute qualité avec
poche intérieure séparée pour
toute sortes d'outils

Dakdekkers
gereedschapset
in rugzak, 50-dlg.

Hoogwaardige rugzak
met apart binnenvak
voor diverse gereedschappen



YouTube



enthaltend/containing/composition



5 m



195 - 570 mm



230 mm



200 mm



260 mm



400 mm



200 mm



200 mm



200 mm / 8"



400 mm



Geprüft nach
DIN EN 166 F

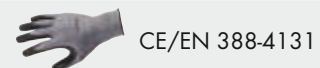

CE/EN 388-4131



Gr. 18 mm



600 g

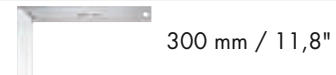

300 mm / 11,8"



17+22er
Zahnung
teeth per inch



315 mm
19 x 22



Bestell-No./Order-No.

50810525000

Art. No.

5081052-5

Maße · Dimensions

460 x 350 x 180 mm



8100



1

50879
50880
50882
50885
50886

**Drehmomentschlüssel
mit Hebelumschaltknarre**

Chrom-Vanadium
in Kunststoffbox

**Clé dynamométrique
avec cliquet réversible**

Chrome-Vanadium
en coffret plastique

**Momentsleutel met
omschakelpal**

Chroom-Vanadium
in kunststof koffer

1/4"
3/8"
1/2"
3/4"



Impact-Steckschlüssel-Einsätze
finden Sie auf den Seiten 111-112
Kracht dopsleutels vindt u op
pagina 111-112

Hebelumschaltknarre
mit Auswerferstift zum
Schnelllösen der Steckverbindung

Cliquet réversible
tige d'éjection pour libérer
rapidement l'outil du cliquet

Omschakelbare ratel
met ontgrendelstift

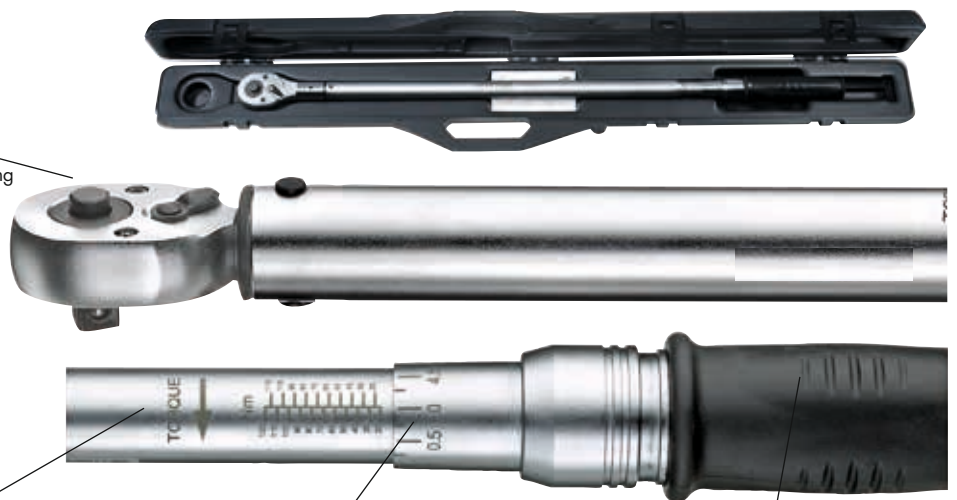

Gut einstellbare, deutlich lesbare Skala
Echelle de graduation facilement ajustable
et très lisible
Goed instelbaar, duidelijk afleesbare
schaalverdeling

Verriegelung des eingestellten Drehmomentwertes
Verrouillage du couple sélectionné
Vergrendeling van het ingestelde draaimoment

Rutschfester Drehgriff für sichere Handhabung
und zum Einstellen des Drehmomentwertes
Poignée tournante anti-glisse pour une
prise en main sûre et pour régler le couple
Anti-slip greep voor stevige grip en voor het
instellen van het draaimoment

Bestell-No./Order-No.	Art. No.	■	Nm	GLD mm	g	📦
50879000080	50879	1/4"	3-15	190-210	290	1
50880000080	50880	1/4"	4-20	300-320	865	1
50882000080	50882	3/8"	20-120	405-435	1665	1
50885000080	50885	1/2"	40-200	485-510	2020	1
50886000080	50886	3/4"	100-600	1035-1052	5047	1

508201-614

Drehmomentschlüssel,
Festwert 140 Nm

Cle dynamometrique
valeur, 140 Nm

Draaimomentsleutel,
140 Nm

1/2"

new



Bestell-No./Order-No.	Art. No.	Nm	CLØ mm	g	
new 50820161483	508201-614	140	410	1021	1

50895-1

Einsteckknarre

Cliquet à
emmanchement

Insteekratel

Chrom-Vanadium, verchromt
umschaltbar, 72 Zähne

Chrome-Vanadium, chromées avec
cliquet réversible, 72 dents

Chroom-Vanadium, verchromd,
omschakelbaar, 72 tanden

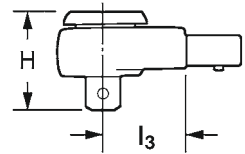

Bestell-No./Order-No.	Art. No.	■	L2 mm	D mm	H mm	für • pour • voor	g	
50895100080	50895-1	1/2"	5,9	6,5	11,1	50895	40	1

50895-31

Einsteckmaulschlüssel

Clé à fourche à
emmanchement

Insteeksteeksleutel

Chrom-Vanadium

Chrome-Vanadium

Chroom-Vanadium

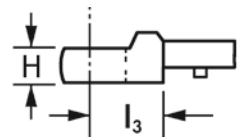
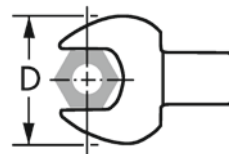

Bestell-No./Order-No.	Art. No.	⊙MM	L3 mm	D mm	H mm	für • pour • voor	g	
50895311380	50895-31	13	25,0	30,0	7,0	50895	125	1
50895311480	50895-31	14	25,0	32,0	7,0	50895	130	1
50895311780	50895-31	17	25,0	37,0	9,0	50895	130	1
50895311880	50895-31	18	25,0	39,0	9,0	50895	145	1
50895311980	50895-31	19	25,0	41,0	9,0	50895	145	1
50895312280	50895-31	22	25,0	47,0	11,0	50895	165	1
50895312480	50895-31	24	25,0	51,0	11,0	50895	170	1
50895312780	50895-31	27	32,5	58,5	13,0	50895	215	1
50895313080	50895-31	30	32,5	63,0	13,0	50895	245	1

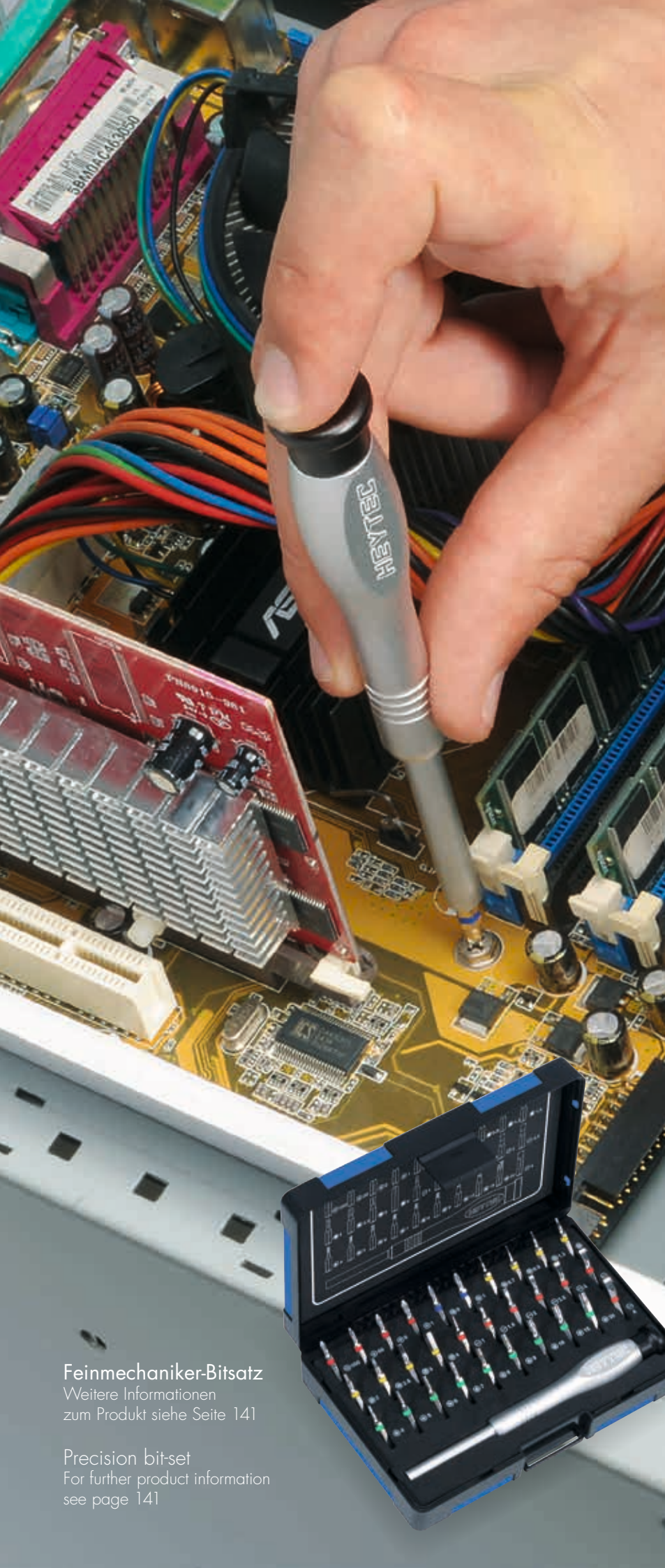

100% Kundenzufriedenheit

So urteilen unsere Anwender:

„Der Kasten ist in jeder Hinsicht Oberklasse, der Griff modisch aber gut. Ich würde den Artikel jederzeit wieder kaufen und kann ihn mit bestem Gewissen empfehlen.“

„Ein Qualitätsprodukt mit sehr gutem Preis-Leistungs-Verhältnis.“

„Habe gleich nach Erhalt den ersten Einsatz getestet. Bits sind gut und sauber verarbeitet und das Griffstück liegt ebenfalls sehr gut in der Hand. Macht einen wertigen Eindruck.“

„Warum können nicht mehr Hersteller ihre Produkte mit Augenmerk auf Qualität und Langlebigkeit planen? Dieses Set ist einfach super verarbeitet!“

100% Customer satisfaction

Here´s what our customers say:

„In every respect, this is a premium quality set. The grip is trendy but well designed. I can highly recommend this set and would surely buy it again.“

„A premium quality product offering high value for money.“

„I put the set to test immediately after I had received it. Bits are well finished doing a great job. The handle lies well in your hand, too. Generally, this set leaves an impression of high quality.“

„Why can't other tool makers design their products with a focus on quality and longevity? This set is really well built!“

Feinmechaniker-Bitsatz
Weitere Informationen
zum Produkt siehe Seite 141

Precision bit-set
For further product information
see page 141

Radwechsel-Werkzeug-
satz, 8-tlg.

Für den schnellen und einfachen Radwechsel am PKW, zur Aufbewahrung in der Ersatzradmulde im Kofferraum.

- Drehmomentschlüssel, Festwert 140 Nm, 1/2" - Antrieb
- Extra lange Steckschlüsseleinsätze, Chrom-Vanadium Stahl
- Aufbewahrungsbox leer, für Felgenschloss/Radschrauben
- Umsteckschraubendreher
- Lichtstreifen 18 LED mit Schalter, spritzwassergeschützt
- 4 Batterien 1,5 V AA inklusive
- Sicherheitsreflektor, beidseitig
- Integriertes Kniebrett
- Batteriefach rückseitig, spritzwassergeschützt
- Hochwertiger 2-K Schaumstoff

Kit démontage de roues,
8 pcs.

Kit pour changement rapide et facile de roues de voitures.

- Clé dynamométrique, 140 Nm, 1/2"
- Douilles extra-longues Chrome Vanadium
- Boîte de rangement vide pour verrouillage ou vis
- Tournevis réversible, plat et cruciforme
- Bande lumineuse avec 18 LED, résistant à l'eau
- 4 batteries AA, 1.5 V inclus
- Bandes réfléchissantes des deux côtés
- L'emballage est également une mousse pour les genoux
- Compartiment à piles sur le dos, résistant à l'eau

Wielwissel gereed-
schapset, 8 dlg.

Gereedschapset voor het snel en eenvoudig wisselen van wielen bij personenauto's.

- Draaimomentsleutel, 140 Nm, 1/2" aansluiting
- Extra lange dopsleutels, chroom vanadium staal
- Lege bewaardoos, voor velgsloten en wielmoeren
- Omsteek schroevendraaier, sleuf/ kruiskop
- Lichtbalk met 18 LED's en schakelaar, spatwaterdicht
- Inclusief 4 batterijen AA, 1,5V
- Veiligheidsreflector aan beide zijden
- Geïntegreerde kniemat
- Batterijvak aan de achterkant, spatwaterdicht

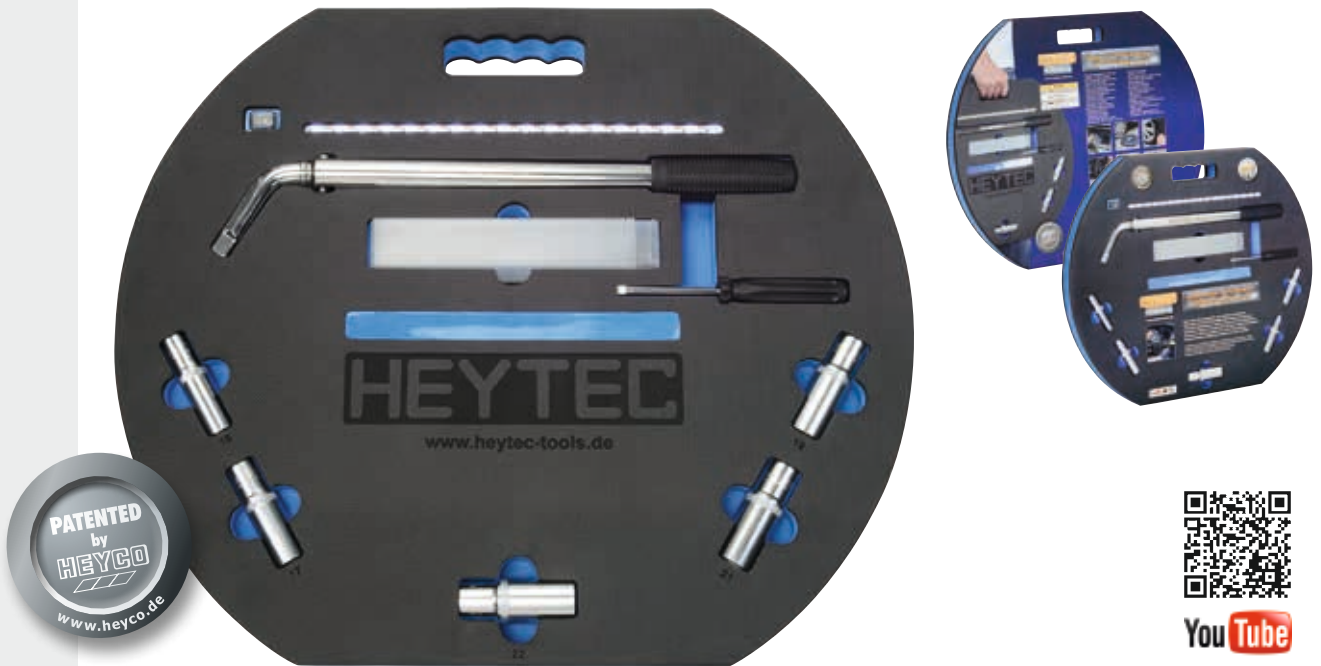

enthaltend/containing/composition	
	CL ⇄ 410 mm Drehmomentschlüssel / Torque wrench, 140 Nm
	CL ⇄ 75 mm MM 15/17/19/21/22
	CL ⇄ 160 mm + -
	CL ⇄ 200 mm Radmutterbox / Wheel nut box

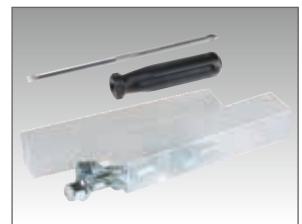
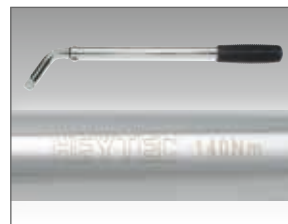

Bestell-No./Order-No.	Art. No.	Maße · Dimensions		
50820160900	5082016	L 550 x B 470 x H 40 mm	2500	1

5086300-B
5086300-19-B



Impact-Steckschlüssel

Chrom-Molybdän-Stahl, mit Kunststoffhülse und Kunststoffeinsatz zum Schutz von Alufelgen. Mit Kugelfangrinne und Bohrung, gefederte Magnethalterung für Hand- und Schlagschrauberbetrieb.

Douilles impact

Acier au Chrome-Molybdène, avec gaine plastique de protection des jantes en aluminium. Avec élément de retenue de la bille, pour utilisation à main et à choc.

Krachttop

Chroom-Molybdeenstaal, met kunststof huls en kunststof inleg ter bescherming van aluminium velgen met kogelvanggroef en boring, verende magneet voor hand- en slagschroevendraaiergebruik.

5086300-B



- Magnetische Aufnahme
- Sicherer Halt für die gelöste Mutter
- Federnder Einsatz
- Maximaler Formschluss durch Längenanpassung

Bestell-No./Order-No.	Art. No.	MM	mm	g	
50863001730	5086300-B	17	85	216	1
50863001930	5086300-B	19	85	227	1
50863002130	5086300-B	21	85	250	1
50863002230	5086300-B	22	85	250	1

5086300-19-B



Bestell-No./Order-No.	Art. No.	MM	mm	g	
50863191730	5086300-19-B	17	150	375	1
50863191930	5086300-19-B	19	150	400	1

5086300 -
5086300-19



Impact-Steckschlüssel

Chrom-Molybdän-Stahl, mit Kunststoffhülse und Kunststoffeinsatz zum Schutz von Alufelgen. Mit Kugelfangrinne und Bohrung, für Hand- und Schlagschrauberbetrieb.

Douilles impact

Acier au Chrome-Molybdène, avec gaine plastique de protection des jantes en aluminium. Avec élément de retenue de la bille, pour utilisation à main et à choc.

Krachttop

Chroom-Molybdeenstaal, met kunststof huls en kunststof inleg ter bescherming van aluminium velgen met kogelvanggroef en boring, hand- en slagschroevendraaiergebruik.

5086300



Bestell-No./Order-No.	Art. No.	MM	mm	g	
50863001760	5086300	17	85	216	1
50863001960	5086300	19	85	227	1
50863002160	5086300	21	85	255	1

5086300-19



Bestell-No./Order-No.	Art. No.	MM	mm	g	
50863191760	5086300-19	17	150	375	1
50863191960	5086300-19	19	150	400	1
50863192160	5086300-19	21	150	440	1

5086300-3



Impact-Steckschlüssel- satz

3-tlg. mit Kunststoffhülse in Box

Composition de douilles impact

3 pièces avec gaine
plastique en boîte

Kracht dopsleutelset

3 delig met kunststof hulzen in box



Bestell-No./Order-No.	Art. No.	MM	mm		
50863000300	5086300-3	17/19/21	85	820	1

5086300-19-3

Impact-Steckschlüssel- satz

6-tlg. mit Kunststoffhülse in Box,
extra lang für Tiefbettfelgen,
SW 17, 19, 21 mm
+ 3 Ersatz Kunststoffschonhülsen

Composition de douilles impact

6 pièces avec gaine plastique en
boîte, extra-longues pour jantes à
base creuse SW 17, 19, 21 mm
et 3 gaines plastique de rechange

Kracht dopsleutelset

6 delig met kunststof hulzen in box
extra lang voor brede velgen
SW 17, 19, 21 mm + drie reserve
kunststof hulzen



Bestell-No./Order-No.	Art. No.	MM	mm		
50863190300	5086300-19-3	17/19/21	150	1460	1

50253

Greifzange

Mit durchgestecktem Gleitgelenk,
Chrom-Vanadium, lackiert,
teilweise geschliffen, Griffe
kunststoffbeschichtet

Pinces multiprise

Charnière entrepassée et glissière,
Chrom-Vanadium, laquées
partiellement meulée, branches
gainées plastique

Waterpomptang

Met doorgestoken scharnier
Chroom-Vanadium, gelakt,
gedeeltelijk geslepen, grepen met
kunststof overtrokken



Bestell-No./Order-No.	Art. No.	mm		
50253320834	50253	250	385	1

**5081330/
5081331**

Eckrohrzangen

Kopf induktiv gehärtet und poliert, pulverbeschichtet, Rolle unverlierbar

Clé en tube coudée

Tête trempée par induction et polie, revêtement par pulvérisation, bille imperdable

Hoekpijptang

Chroom-Vanadium, kop inductief gehard en gepolijst, poedergecoat



Bestell-No./Order-No.	Art. No.	Ø mm	Ø "	g	
50813301020	5081330	320	1	800	1
50813301520	5081330	425	1.1/2	1450	1
50813311020	5081331	320	1	760	1
50813311520	5081331	425	1.1/2	1450	1

5081200

**Kombinationszange,
DIN ISO 5746**

Kopf geschliffen und lackiert, Griffe mit 2-K Kunststoffhandschutz, Schneide für mittelharten Draht

**Pince universelle,
DIN ISO 5746**

Chromées et laquées branches gainées plastique à 2 composantes, pour fil de dureté moyenne

**Combinatietang,
DIN ISO 5746**

Kop gepolijst en gelakt, greep uit 2 componenten kunststof, knipt middelharde draad



Bestell-No./Order-No.	Art. No.	Ø mm	g	
50812001842	5081200	180	260	1

5081208

**Flachrundzange,
gerade, DIN ISO 5745**

Kopf geschliffen und lackiert, Griffe mit 2-K Kunststoffhandschutz, Schneide für mittelharten Draht

**Pince à becs demi-ronds,
droits, DIN ISO 5745**

Chromées et laquées branches gainées plastique à 2 composantes, pour fil de dureté moyenne

**Telefoontang,
recht, DIN ISO 5745**

Kop gepolijst en gelakt, greep uit 2 componenten kunststof, knipt middelharde draad

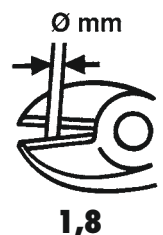

Bestell-No./Order-No.	Art. No.	Ø mm	g	
50812082042	5081208	200	185	1

5081209

Flachrundzange,
45° abgewinkelt,
DIN ISO 5745

Kopf geschliffen und lackiert, Griffe
mit 2-K Kunststoffhandschutz,
Schneide für mittelharten Draht

Pince à becs demi-ronds,
coudés à 45°,
DIN ISO 5745

Chromées et laquées branches
gainées plastique à 2 composantes,
pour fil de dureté moyenne

Telefoontang,
45° gebogen,
DIN ISO 5745

Kop gepolijst en gelakt, greep uit
2 componenten kunststof, knipt
middelharde draad



Bestell-No./Order-No.	Art. No.	CLØ mm		
50812092042	5081209	200	185	1

5081212

Kraftseitenschneider,
DIN ISO 5749

Spezialstahl, Kopf geschliffen
und lackiert, Griffe mit 2-K
Kunststoffhandschutz, Schneide für
harten Draht (Piano Draht)

Pincés coupantes
diagonales
DIN ISO 5749

Acier spécial, chromées et laquées
branches gainées plastique à
2 composantes, pour fil dur
(corde à piano)

Kracht zijsnijtang
DIN ISO 5749

Speciaalstaal, kop gepolijst en
gelakt, greep uit 2 componenten
kunststof, knipt harde draad
(pianodraad)

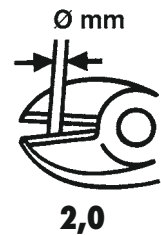

Bestell-No./Order-No.	Art. No.	CLØ mm		
50812121842	5081212	180	255	1

5081213

Seitenschneider,
schwedische Form,
DIN ISO 5749

Kopf geschliffen und lackiert, Griffe
mit 2-K Kunststoffhandschutz,
Schneide für mittelharten Draht

Pincés coupantes
diagonales modèle
suédois, DIN ISO 5749

Chromées et laquées branches
gainées plastique à 2 composantes,
pour fil de dureté moyenne

Zijsnijtang,
zweeds model,
DIN ISO 5749

Kop gepolijst en gelakt, greep uit
2 componenten kunststof, knipt
middelharde draad



Bestell-No./Order-No.	Art. No.	CLØ mm		
50812131642	5081213	160	220	1

5081241
**Kneif-/Rabitzzange,
DIN ISO 9242A**

Mattschwarz lackiert
mit polierten Backen, tauchisoliert
Schneide für mittelharten Draht

**Tenaille,
DIN ISO 9242A**

Laquée noir mat
avec becs polis, poignées isolées

**Moniertang,
DIN ISO 9242A**

Matzwart gelakt
met gepolijste bekken,
dompelisolatie



Bestell-No./Order-No.	Art. No.	Ø mm	g	Box
50812412213	5081241	230	330	1
50812412513	5081241	250	410	1

5081242
**Kantenzange,
DIN 5241**

Mattschwarz lackiert
mit polierten Backen, tauchisoliert

**Tenaille de menuisier,
DIN 5241**

Laquée noir mat
avec becs polis, poignées isolées

**Nijptang,
DIN 5241**

Matzwart gelakt
met gepolijste bekken,
dompelisolatie



Bestell-No./Order-No.	Art. No.	Ø mm	g	Box
50812422013	5081242	200	430	10

5081670
Profi Universal-Schere

- Edelstahl Klingen mit feinsten Sägezahnprofilierung für hohe Standzeiten und beste Schneideergebnisse
- Ergonomischer 2-K Griff
- Einhändige Verriegelung
- Abisolierung von Drähten mit den Durchmessern 1 mm², 1,5 mm², 2 mm²
- Ideal geeignet zum Schneiden von dünnen Blechen, Drähten, Kunststoffen, Leder und Teppichen
- Einkerbung in der Klinge erleichtert das Schneiden von runden Materialien
- Automatische Öffnung durch innenliegende Feder

**Ciseaux universels
professionnels**

- lame en acier inoxydable avec dents de scie très fin pour une longue vie et meilleurs résultats de coupe
- Poignée ergonomique à deux composants
- Blocage d'une seule main
- Dénudage des fils d'un diamètre de 1 mm², 1,5 mm², 2 mm²
- Idéal pour la découpe de tôles légers, les fils, les plastiques, le cuir et les tapis
- Entaille dans la lame facilite la coupe de matériaux ronds
- Ouverture automatique par ressort interne

**Professionele
universeelschaar**

- RVS bek met zeer fijne vertanding voor hoge standtijd en beter snijresultaat
- Ergonomische 2-componenten greep
- Eenhands vergrendeling
- Voor strippen van draden met een doorsnede van 1, 1.1/2 en 2 mm²
- Ideaal voor knippen van dun blik, draad, kunststof, leer en tapijt
- Inkeping in de bek maakt knippen van ronde materialen makkelijker
- Automatisch openen door geïntegreerde veer

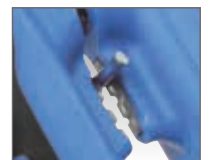

Bestell-No./Order-No.	Art. No.	Ø mm	g	Box
50816700800	5081670	200	180	1



Intelligent konzipiert, stark konstruiert

Saugheber

Weitere Informationen
zum Produkt siehe Seite 165

Intelligent concepts, perfectly engineered

Vacuum lifting pad

For further product information
see page 165



5081259

Multifunktionszange

- 2-K-Griff aus hochwertigem Luffahrt-Aluminium mit Kunststoffeinlage
- Flachrundzange
- Standardzange
- Drahtschneider
- Säge
- Dosenöffner
- kleiner Schraubendreher
- Kreuzschlitz-Schraubendreher
- Messer
- Feile mit Schraubendreher
- Fischenschupper
- Hakenlöser
- Flaschenöffner

Pince multifonction

- Avec poignée en 2K, fabriqué en aluminium de haute qualité aéronautique et avec insert en plastique
- Pince à bec demi rond
- Pince standard
- Coupe fil
- Scie
- Ouvre-boîte
- Petit-tournevis
- Tournevis Philips
- Couteau
- Lime avec tournevis
- Ecailleur à poisson
- Dégorgeoir
- Ouvre bouteille

Mini Multitool

- Met 2 componentengreep uit hoogwaardig luchtvaartaluminium met kunststof inleg
- Telefoontang
- Draadknipper
- Zaag
- Blikopener
- Schroevendraaier voor zaagsnede
- Kruiskopschroevendraaier
- Mes
- Vijl
- Gekarteld mes
- Flesopener

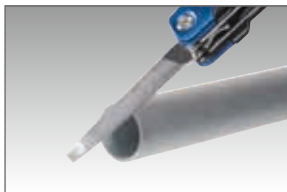

Bestell-No./Order-No.	Art. No.	Ø mm	g	mm
50812590000	5081259	160	180	1
*50812591200	5081259-12	160	2160	1

*Lieferung im Verkaufdisplay • Livraison en présentoirs • Levering in het verkoopdisplay

5081259-1

Multifunktionszange mit Gürteltasche

Pince multi usage avec sac de ceinture

Mini multitool met riemtas



Lieferung in Blisterverpackung / Supplied in blister packing / Livré sous blister

Bestell-No./Order-No.	Art. No.	Ø mm	g	mm
50812590100	5081259-1	160	195	1

5081280

Gripzange

Lösehebel mit Kunststoffhülle

Pincés-étaux

Levier de déclenchement gainé plastique

Griptang

Ontspanhendel met kunststof overtrokken



Bestell-No./Order-No.	Art. No.	CLD mm	g	1
50812802550	5081280	235	440	1

5081621-1

Hebelblechschere, gerade und rechts- schneidend

Geschmiedete Schneiden aus Chrom-Vanadium, gezahnt, Kunststoffhüllen mit Gleitschutz

Cisailles à tôle démultipliées chantourneuse à droite

Tranchant forgé en Chrome-Vanadium, denté, gaines plastique avec protection anti-glisse

Blikschaar, recht, rechts

Gesmede bekken van Chrom-Vanadium, getand, kunststof grepen met anti-slip



Bestell-No./Order-No.	Art. No.	CLD mm	g	1
50816210132	5081621-1	260	490	1

5081647-35

Schlauchschneidezange

- Zum einfachen Schneiden und Durchtrennen von Schläuchen aus PVC und Gummi
- Schneidekapazität Ø 6-35 mm
- Griff mit PVC-Isolierung für optimale Handhabung
- Doppelte Standzeit/ Lebensdauer, aufgrund von Doppelklingenfunktion, Halterung lösen und Klinge um 90° drehen

Pince coupe tuyau

- Pour couper et diviser facilement des tubes en PVC et caoutchouc
- Capacité de coupe diamètre 6-35 mm
- Poignée avec isolation PVC pour une manipulation optimale
- Cycle de vie double grâce à la fonction double lame, retirez le support et faire tourner la lame de 90 degrés

Slangknipper

- Voor het eenvoudig en recht snijden van slangen van PVC en rubber
- Snijscapaciteit Ø 6-35 mm
- Greep met PVC-isolatie voor stevige grip
- Dubbele levensduur dankzij tweevoudige klingfunctie, verwijder de klem en roteer het mes 90

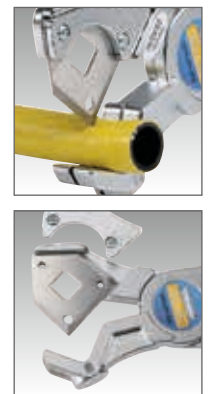

Bestell-No./Order-No.	Art. No.	CLD mm	g	1
50816473500	5081647-35	255	440	1
*50816470000	5081647		20	1

*Ersatzmesser • Spare blade • Lame de rechange

5081720

Stablampe mit LED-Licht

Stufenlos ausziehbar
mit magnetischem Leuchtkopf

Lampe torche „LED“

Progressivement extensible,
avec tête magnétique éclairante

Zaklantaarn met LED licht

Traploos uitschuifbaar,
met magnetische kop



Bestell-No./Order-No.	Art. No.	mm		g	
50817200000	5081720	195 - 570	1500 g	116	1

5081730

Stirnleuchte mit LED-Licht

3 Helligkeitsstufen schaltbar,
zusätzlich Blinklicht bei Volllicht,
verstellbare elastische Haltebänder

Lampe frontale „LED“

3 intensités d'éclairage, en plus,
lumière clignotante en position
maximale, support élastique
réglable

Hoofdlamp met LED licht

3 lichtsterktes instelbaar,
knipperfunctie bij volledige sterkte,
verstellbare, elastische helmband



Lieferung ohne Helm Livrée sans casque de chantier Levering zonder helm

Bestell-No./Order-No.	Art. No.	g	
50817300000	5081730	120	1



Unter Spannung

Bei allen Arbeiten an spannungsführenden Teilen steht die Sicherheit an oberster Stelle. Dazu gehört auch der Einsatz von speziell hierfür hergestellten isolierten Werkzeugen. Diese müssen den internationalen Normen entsprechen und alle Prüfungen hinsichtlich mechanischer und elektrischer Sicherheit bestehen. Wir können mit Überzeugung sagen, dass wir Ihnen die besten Werkzeuge, die alle sicherheitsrelevanten Kriterien erfüllen, an die Hand geben.

Electrifying quality

Safety is always the top priority when working on live electrical systems. This also requires the use of insulated tools specially manufactured for the job. These must fulfil international standards and pass all tests with regard to mechanical and electrical safety. We can say with absolute certainty that we provide only the best tools that fulfil all safety-relevant criteria.



5081052-27



Elektriker Rucksack mit VDE-Werkzeug-sortiment, 26-tlg.

Hochwertiger Rucksack mit separater Innentasche für Werkzeuge aller Art

Nach IEC 60900, DIN 7437 und DIN 7438 PZ

Sac à dos pour électricien avec ensemble d'outils VDE, 26 pcs.

Sac à dos de haute qualité avec poche intérieure séparée pour toutes sortes d'outils

Conforme aux IEC 60900, DIN 7437 et DIN 7438 PZ

Electriciëns rugzak met VDE gereedschapset, 26-dlg.

Hoogwaardige rugzak met apart binnenvak voor diverse gereedschappen

Volgens IEC 60900, DIN 7437 en DIN 7438 PZ



YouTube

enthaltend/containing/composition



180 mm



160 mm



200 mm



160 mm



200 mm



150 - 250 V



115 - 195 mm



110 mm



200 mm



205 mm



MM 8/9/10/11/13/14/17/19



230 mm



MM 4,0 x 100 / 5,5 x 125 / 2,5 x 75



PZ 1 / 2



300 g

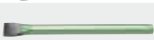

24 x 250 mm

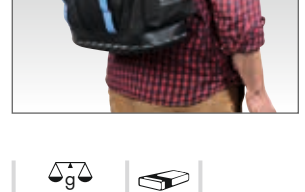

Bestell-No./Order-No.	Art. No.	Maße · Dimensions		
50810522700	5081052-27	460 x 350 x 180 mm	6600	1

5081052-28



Elektriker Rucksack mit VDE-Werkzeug-sortiment, 28-tlg.

Hochwertiger Rucksack mit separater Innentasche für Werkzeuge aller Art

Nach IEC 60900, DIN 7437 und DIN 7438 PZ

Sac à dos pour électricien avec ensemble d'outils VDE, 28 pcs.

Sac à dos de haute qualité avec poche intérieure séparée pour toutes sortes d'outils

Conforme aux IEC 60900, DIN 7437 et DIN 7438 PZ

Electriciëns rugzak met VDE gereedschapset, 28-dlg.

Hoogwaardige rugzak met apart binnenvak voor diverse gereedschappen

Volgens IEC 60900, DIN 7437 en DIN 7438 PZ



enthaltend/containing/composition

	180 mm
	160 mm
	200 mm
	160 mm
	200 mm
	150 - 250 V
	115 - 195 mm
	110 mm
	200 mm
	205 mm
	MM 8/9/10/11/13/14/17/19
	230 mm
	MM 4,0 x 100 / 5,5 x 125 / 2,5 x 75
	PZ 1 / 2
	300 g
	24 x 250 mm
	12 - 690 V
	12 - 1000 V

Bestell-No./Order-No.	Art. No.	Maße · Dimensions		
5081052800	5081052-28	460 x 350 x 180 mm	6900	1

50848-1

Umhängetasche für Werkzeuge, leer

Hochwertige Aufbewahrungstasche mit Klemmhaltesystem sowie Einsteckfächern für Werkzeuge aller Art

Ausstattungsmerkmale:

- Gepolsterter Trageriemen
- Robuster Tragegriff
- Ausklappbarer Stellfuß für sicheren Stand
- Kleinteilmagazin
- Geschütztes, gepolstertes Laptop-Fach
- Zusätzliches Fach für Dokumente

Sac pour outils, vide

Sac de rangement de haute qualité avec système de serrage, ainsi que des poches pour tous types d'outils

Caractéristiques:

- Bandoulière rembourrée
- Poignée de transport robuste
- Pli pied réglable pour plus de stabilité
- Pour petites pièces
- Protégé, compartiment rembourré pour ordinateur portable
- Compartiments à documents

Leren gereedschapstas

Hoogwaardige gereedschapstas met gereedschapsklemmen en insteekvakken voor allerhande gereedschappen

Uitgerust met:

- Gepolsterde draagriem
- Robuuste draaggriep
- Uitklapbare stelvoet
- Vakkendoos voor kleine materialen
- Beschermd, gepolsterd laptopvak
- Extra vak voor documenten



Bestell-No./Order-No.	Art. No.	Maße · Dimensions	g	
5084801000	50848-1	555 x 410 x 180 mm	2400	1

50848-27



Elektrikertasche mit VDE-
Werkzeugsortiment,
28-tlg.

Nach IEC 60900, DIN 7437 und
DIN 7438 PZ

Sac de électriciens avec
sélection de outillage
VDE, 28 pces.

Conforme aux IEC 60900,
DIN 7437 et DIN 7438 PZ

VDE elektriciens-
gereedschapset in tas,
28 delig

Volgens IEC 60900,
DIN 7437 en DIN 7438 PZ



enthaltend/containing/composition	
	180 mm
	160 mm
	200 mm
	160 mm
	200 mm
	12 - 690 V
	150 - 250 V
	115 - 195 mm
	110 mm
	200 mm
	205 mm
	MM 8/9/10/11/13/14/17/19
	230 mm
	MM 4,0 x 100 / 5,5 x 125 / 2,5 x 75
	PZ 1 / 2
	300 g
	24 x 250 mm
	12 - 1000 V

Bestell-No./Order-No.	Art. No.	Maße · Dimensions		
50848002700	50848-27	555 x 410 x 180 mm	6380	1



50848-26

Elektrikertasche mit VDE-Werkzeugsortiment, 26-tlg.

Nach IEC 60900, DIN 7437 und DIN 7438 PZ

Sac de électriciens avec sélection de outillage VDE, 26 pcs.

Conforme aux IEC 60900, DIN 7437 et DIN 7438 PZ

VDE elektriciëns-gereedschapset in tas, 26 delig

Volgens IEC 60900, DIN 7437 en DIN 7438 PZ

enthaltend/containing/composition

	180 mm
	160 mm
	200 mm
	160 mm
	200 mm
	150 - 250 V
	115 - 195 mm
	110 mm
	200 mm
	205 mm
	MM 8/9/10/11/13/14/17/19
	230 mm
	MM 4,0 x 100 / 5,5 x 125 / 2,5 x 75
	PZ 1 / 2
	300 g
	24 x 250 mm

Bestell-No./Order-No.	Art. No.	Maße · Dimensions		
50848002600	50848-26	555 x 410 x 180 mm	6105	1

50849-11

VDE-Werkzeugsatz, 11-tlg.

Mit hochwertiger 2-K Schaumstoffeinlage in hochwertigem Kunststoffkoffer, nach IEC 60900

Sélection d'outillage VDE, 11 pcs.

Avec intérieur mousse à 2 composantes en coffret plastique, conforme aux spécifications IEC 60900

VDE gereedschapset, 11 delig

Met 2 componenten schuimleg in hoogwaardige kunststof koffer, volgens IEC 60900

enthaltend/containing/composition

	180 mm
	160 mm
	200 mm
	160 mm
	150 - 250 V
	115 mm
	MM 0,4 x 2,5 x 100 / 0,8 x 4,0 x 100 / 1 x 5,5 x 100
	PH 1 x 100 / 2 x 100



Bestell-No./Order-No.	Art. No.	Maße · Dimensions		
50849001100	50849-11	390 x 310 x 60 mm	575	1

50846-33



VDE-Elektrikersatz,
18-tlg.

In Rolltasche mit Gürtelschlaufe.
Nach IEC 60900:2004
270

Outils pour électricien
VDE, 18 pces.

En trousse avec sac de ceinture.
IEC 60900:2004
270

VDE elektriciëns-set,
18 delig

In rolltas met riemlus.
Volgens IEC 60900:2004
270

50846-33



enthaltend/containing/composition

	MM 0,4 x 2,5 x 100 / 0,6 x 3,5 x 100 / 0,8 x 4,0 x 100 / 1 x 5,5 x 100
	TX 10 x 100 / 15 x 100 / 20 x 100
	PZ 1 x 100 / 2 x 100
	PH 1 x 100 / 2 x 100
	150 - 250 V
	5 mm / 7 - 8 mm
	9 mm
	3 - 5 mm
	115 mm



Bestell-No./Order-No.	Art. No.	Maße · Dimensions		
50846000033	50846-33	220 x 130 x 70 mm	575	1

50847-33



VDE-Elektrikersatz,
8-tlg.

In Rolltasche mit Gürtelschlaufe.
Nach IEC 60900:2004
270

Outils pour électricien
VDE, 8 pces.

En trousse avec sac de ceinture.
IEC 60900:2004
270

VDE elektriciëns-set,
8 delig

In rolltas met riemlus.
Volgens IEC 60900:2004
270

50847-33



enthaltend/containing/composition

	MM 0,4 x 2,5 x 100 / 0,6 x 3,5 x 100 / 0,8 x 4,0 x 100 / 1 x 5,5 x 100
	PH 1 x 100 / 2 x 100
	115 mm



Bestell-No./Order-No.	Art. No.	Maße · Dimensions		
50847000033	50847-33	220 x 100 x 50 mm	350	1

50849-14



VDE-Elektrikersatz in
Gürteltasche, 13-tlg.

Nach IEC 60900,
DIN 7437 u. DIN 7438 PZ

Outils pour électricien
VDE en sac de ceinture,
13 pces.

Conforme aux spécifications
IEC 60900 : DIN 7437 et
DIN 7438 PZ

VDE elektriciëns-set in
riemtas, 13 delig

Volgens IEC 60900 : DIN 7437
en DIN 7438 PZ



enthaltend/containing/composition	
	180 mm
	160 mm
	200 mm
	200 mm
	115 - 195 mm
	195 - 570 mm
	12 - 690 V
	150 - 250 V
	MM 0,5 x 2,5 x 75 / 0,8 x 4,0 x 100 / 1,0 x 5,5 x 125
	PZ 1/2

Bestell-No./Order-No.	Art. No.	Maße · Dimensions		
50849001400	50849-14	380 x 300 x 100 mm	2225	1

Modul *
M 50829-18**



VDE-Werkzeugsortiment
in 2-K Schaumstoff-
einlage, 12-tlg.*

Nach IEC 60900,
DIN 7437 u. DIN 7438 PZ

Sélection d'outillage VDE
avec intérieur mousse à
2 composantes,
12 pces.*

Conforme aux spécifications
IEC 60900 : DIN 7437 et
DIN 7438 PZ

VDE gereedschapset
in 2 componenten
schuimleg,
12 delig*

Volgens IEC 60900 : DIN 7437
en DIN 7438 PZ

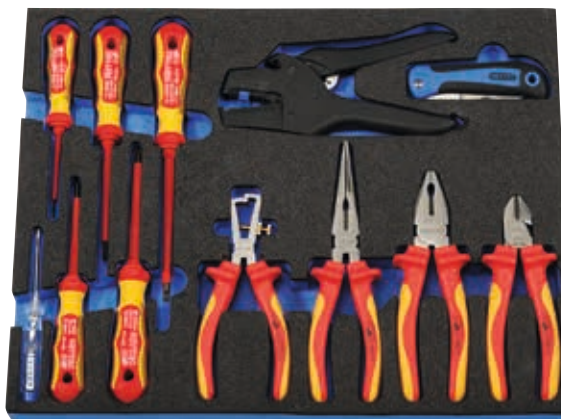

enthaltend/containing/composition	
	180 mm
	160 mm
	200 mm
	160 mm
	200 mm
	115 - 195 mm
	150 - 250 V
	MM 0,5 x 2,5 x 75 / 0,8 x 4,0 x 100 / 1,0 x 5,5 x 125
	PZ 1/2

Bestell-No./Order-No.	Art. No.	Maße · Dimensions		
50829001800	M 50829-18	435 x 340 x 35 mm	2910	1

* Passend für HEYTEC-Werkstattwagen 5081129 · For HEYTEC workshop trolley 5081129
Pour servante d'atelier 5081129

5081200



**VDE Kombinationszange,
DIN ISO 5746**

Kopf geschliffen und lackiert,
Griffe mit 2-K Isoliergriffen
IEC 900/DIN EN 60900,
Schneide für mittelharten Draht

**VDE Pince universelle,
DIN ISO 5746**

Chromées et laquées branches
gainées isolées à 2 composantes
IEC 900/DIN EN 60900,
pour fil de dureté moyenne

**VDE Combinatietang,
DIN ISO 5746**

Kop gepolijst en gelakt, grepen
met 2 componenten isolatiegreep
IEC 900/DIN EN 60900,
knipt middelharde draad



Bestell-No./Order-No.	Art. No.	∅ mm	g	1
50812001888	5081200-VDE	180	260	1

5081208



**VDE Flachrundzange,
gerade, DIN ISO 5745**

Kopf geschliffen und lackiert,
Griffe mit 2-K Isoliergriffen
IEC 900/DIN EN 60900,
Schneide für mittelharten Draht

**VDE Pince à becs
demironds, droits,
DIN ISO 5745**

Chromées et laquées branches
gainées isolées à 2 composantes
IEC 900/DIN EN 60900,
pour fil de dureté moyenne

**VDE Telefoontang,
recht,
DIN ISO 5745**

Kop gepolijst en gelakt, grepen
met 2 componenten isolatiegreep
IEC 900/DIN EN 60900,
knipt middelharde draad

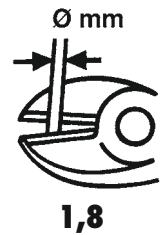
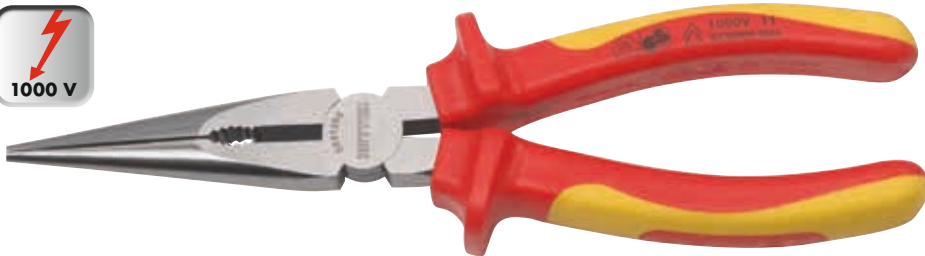

Bestell-No./Order-No.	Art. No.	∅ mm	g	1
50812082088	5081208-VDE	200	185	1

5081209



**VDE Flachrundzange,
45° abgewinkelt,
DIN ISO 5745**

Kopf geschliffen und lackiert,
Griffe mit 2-K Isoliergriffen
IEC 900/DIN EN 60900,
Schneide für mittelharten Draht

**VDE Pince à becs demi-
ronds, coudés à 45°,
DIN ISO 5745**

Chromées et laquées branches
gainées isolées à 2 composantes
IEC 900/DIN EN 60900,
pour fil de dureté moyenne

**VDE Telefoontang,
45° gebogen,
DIN ISO 5745**

Kop gepolijst en gelakt, grepen
met 2 componenten isolatiegreep
IEC 900/DIN EN 60900,
knipt middelharde draad



Bestell-No./Order-No.	Art. No.	∅ mm	g	1
50812092088	5081209-VDE	200	185	1

5081212



VDE Kraftseiten-
schneider,
DIN ISO 5749

Spezialstahl, Kopf geschliffen und lackiert, Griffe mit 2-K Isoliergriffen IEC 900/DIN EN 60900, Schneide für harten Draht (Piano Draht)

VDE Pincés coupantes
diagonales,
DIN ISO 5749

Acier spécial, chromées et laquées branches gainées isolées à 2 composants IEC 900/DIN EN 60900, pour fil dur (corde à piano)

VDE Kracht zijsnijtang,
DIN ISO 5749

Speciaalstaal, kop gepolijst en gelakt, grepen met 2 componenten isolatiegreep IEC 900/DIN EN 60900, knipt harde draad (piano draad)



Bestell-No./Order-No.	Art. No.	CLD mm	g	1
50812121888	5081212-VDE	180	255	1

5081213



VDE Seitenschneider,
schwedische Form,
DIN ISO 5749

Kopf geschliffen und lackiert, Griffe mit 2-K Isoliergriffen IEC 900/DIN EN 60900, Schneide für mittelharten Draht

VDE Pincés coupantes
diagonales, modèle
suédois, DIN ISO 5749

Chromées et laquées branches gainées isolées à 2 composants IEC 900/DIN EN 60900, pour fil de dureté moyenne

VDE Zijsnijtang,
zweeds model,
DIN ISO 5749

Kop gepolijst en gelakt, grepen met 2 componenten isolatiegreep IEC 900/DIN EN 60900, knipt middelharde draad



Bestell-No./Order-No.	Art. No.	CLD mm	g	1
50812131688	5081213-VDE	160	220	1

5081220



VDE Abisolierzange

Kopf geschliffen und lackiert, mit 2-K Isoliergriffhüllen IEC 900/DIN EN 60900, mit Stellschraube und Öffnungsfeder

VDE Pincés à dénuder

Chromées et laquées, avec gaines isolées IEC 900/DIN EN 60900, avec vis de réglage de butée et ressort d'ouverture

VDE Kabelstriptang

Kop gepolijst en gelakt, grepen met 2 componenten isolatiegreep IEC 900/DIN EN 60900, met stelschroef en veer



Bestell-No./Order-No.	Art. No.	CLD mm	g	1
50812201688	5081220-VDE	160	203	1

5081265

Crimpzange

Profi Crimpzange mit Hebelübersetzung. Geschraubtes Gelenk, hohe Stabilität und gleichmäßiger Lauf. Hochfester Spezialstahl. Ergonomischer 2-K Griff für ermüdungsfreies Arbeiten. Zum Kabelschneiden, Abisolieren von Kabeln und Crimpen von isolierten und unisolierten Kabelschuhen und Steckverbindern. Top-Qualität, Multifunktion 5 in 1, Kapazität: 0,75 - 5,5 mm.

- Farbkodierte Querschnitt-zuordnung
- Gewindelöcher zum Abschneiden von Gewindestiften

Sertissage

Sertissage professionnelle avec effet de levier. Charnière boulonnée, grande stabilité et bon fonctionnement. Acier de haute résistance. Manche ergonomique à 2 composants pour travail anti-fatigue. Cutter de cables, dénudage des cables, sertissage des cosses de câble isolées, sertissage des cosses de câble non-isolées. Qualité top, multifonction 5 en 1, capacité: 0,75 - 5,5 mm.

- Coordination des sections à couleur codées
- Trous filetés pour le coupage de vis sans tête

Krimptangen

Professionele krimptang met hefboom overbrenging. Geschroefd scharnier, hoge stabiliteit en gelijkmatige bediening. Hoogsterkte staal. Ergonomische 2-k greep voor comfortabel werken. Kabelschaar, verwijderen van kabelisolatie, Krimpen van geïsoleerde kabelschoentjes, Krimpen van ongeïsoleerde kabelschoentjes. Top kwaliteit, multifunctioneel 5 in 1, capaciteit: 0,75 - 5,5 mm.

- Kleurgecodeerde dwarsdoorsnede
- draadgaten voor het knippen van metaalschroeven

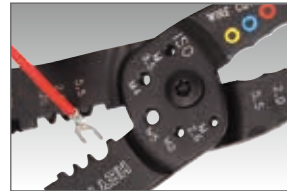

Bestell-No./Order-No.	Art. No.	CLD mm		
5081265000	5081265	200	270	1

5081267

Crimpzangen-Set, 249-tlg.

Zum Kabelschneiden, Abisolieren von Kabeln und Crimpen von isolierten und unisolierten Kabelschuhen und Steckverbindern.

Assortiment pinces à sertir, 249 pcs.

Cutter de cables, dénudage des cables, sertissage des cosses de câble isolées, sertissage des cosses de câble non-isolées.

Krimptangen set, 249 delig

Kabelschaar, verwijderen van kabelisolatie, Krimpen van geïsoleerde kabelschoentjes, Krimpen van ongeïsoleerde kabelschoentjes.

Isolierte Flachsteckhülsen
Insulated Receptacles
10 St./pcs. AWG 22-16 / 16-14

Isolierte Flachstecker
Insulated Tabs (Spade Terminals)
10 St./pcs. AWG 22-16 / 16-14

Stoßverbinder
Butt Connectors
40 St./pcs. AWG 22-16 / 16-14 / 12-10

Unisolierte Ringkabelschuhe
Non-Insulated Ring Terminals
40 St./pcs. AWG 22-16 / 16-14 / 12-10; M3 - M4 - M5

Unisolierte Gabelkabelschuhe
Non-Insulated Fork Terminals
40 St./pcs. AWG 22-16 / 12-10; M3 - M4 - M5

Isolierte Ringkabelschuhe
Insulated Ring Terminals
25 St./pcs. AWG 22-16 / 16-14 / 12-10; M3 - M4 - M5



Isolierte Gabelkabelschuhe
Insulated Fork Terminals
25 St./pcs. AWG 22-16 / 16-14 / 12-10; M3 - M4 - M5

Kabelklemmen
Cable Clamps
10 St./pcs. 1/4" - 1/8"

Gummi-Kabeldurchführungen
Grommets
15 St./pcs. 3/16" - 1/4" - 3/8"

Blindstecker
Blind Plugs
5 St./pcs. AWG 22-16

Niederspannungs-Autosicherungen
Low Voltage Car Fuses
20 St./pcs. 5/10/15/25 A

Kabelschnellverbinder
Quick Splice Connectors
8 St./pcs. AWG 22-16 / 16-14

Bestell-No./Order-No.	Art. No.	Maße · Dimensions		
5081267000	5081267	305 x 215 x 50 mm	930	1

5081426



Spannungsprüfer für 12 - 690 Volt

Inklusive Batterien, Zweipolig, mit LED-Licht, 12/24/50/120/230/400/690 V LEDs für europäische Spannungsanzeige, L/R LEDs für Phasenrotationstest, Strom-LED, Polaritätsanzeige-LEDs für Spannung, LCD Display, Durchgangsprüfung, Hochspannungsanzeige, geprüft nach IEC 61010-1, Schutzart IP 64, automatische Abschaltung

Tournevis détecteurs de tension pour 12 - 690 volt

Batteries incluses, bipolaires, avec lumière led, 12/24/50/120/230/400/690 V LED'S pour l'affichage de tension européenne, L/R pour test de rotation de phase, Power LED, affichage de polarité, LED de puissance, écran LCD, Continuité, Indicateur de haute tension, testés selon la norme IEC 61010-1, IP 64

Spanningtester voor 12 - 690 volt

Incl. batterijen, 2 polig, met LED-Licht, 12/24/50/120/230/400/690 V LED's voor Europese spanningsaanduiding, L/R LED's voor fase rotatietest, stroom LED, polariteitsaanduiding - LED's voor spanning, LCD display, doorgangstest, hoogspanningsaanduiding, getest volgens IEC 61010-1, beschermingsklasse IP 64, automatische uitschakeling

GS: CAT III 690 V
ETL: CAT IV 600 V



Bestell-No./Order-No.	Art. No.	Volt		
5081426000	5081426	12 - 690	275	1

5081428



Berührungsloser Spannungstester 12 - 1000 Volt

Kompaktes 2-K Kunststoffgehäuse, mit optischem und zusätzlich akustischem Signal, Einstellrad für Ein- und Ausschalten sowie zur stufenlosen Anpassung an die zu prüfende Spannung und den örtlichen Gegebenheiten. Berührungsloses Erkennen von spannungsführenden Leitern, z.B. Kabel, Steckdosen, Verteiler, Anschlussdosen etc. Lieferung erfolgt mit Batterien.

Testeur de tension sans contact 12 - 1000 volt

Boîtier compact en matière plastique à 2 composants, avec signal optique et acoustique, une ligne principale pour la mise sous tension et hors tension ainsi que pour le réglage continu de la tension d'essai et les conditions locales. La détection sans contact de conducteurs actifs, par exemple Cordons, fiches, distributeurs, boîtes de jonction, etc. Livré avec batteries.

Contactloze spanningsmeter 12 - 1000 volt

Compact 2-K kunststof behuizing, met optisch en akoestisch signaal, duimwiel voor in- en uitschakelen en voor traploze aanpassing aan de te meten spanning en plaatselijke condities. Contactloze detectie van spanningvoerende leidingen, bijv. kabels, contactdozen, verdeelkasten, stekkerdozen enz. Levering incl. batterijen.



Bestell-No./Order-No.	Art. No.	Volt		
5081428000	5081428	12 - 1000	50	1

**5084511 -
5084536**



VDE Schraubendreher

2K-VDE-Schraubendreher nach IEC 60900 : 2004/VDE 006282 Teil 201 (DIN 7437 u. DIN 7438 PZ), ergonomischer Softgriff, Klingen aus Chrom-Vanadium-Stahl, gehärtet, geschwärzt und mit umspritzter Klingenisolierung

Tournevis VDE

Tournevis VDE à 2 composantes suivant IEC 60900 : 2004/VDE 006282 Section 201 (DIN 7437 et DIN 7438 PZ), poignée souple ergonomique au chrome vanadium, trempée, brunie et avec isolation de la tige par injection

VDE Schroevendraaier

2 componenten VDE schroevendraaier volgens IEC 60900 : 2004/VDE 006282 deel 201 (DIN 7437 et DIN 7438 PZ), ergonomische soft grip. Klingen uit chroom-vanadiumstaal, gehard, gezwart en met omspoten klingisolatie



Bestell-No./Order-No.	Art. No.	+	*	⊖	g	
50845110133	5084511 VDE	PH 1			90	10
50845110233	5084511 VDE	PH 2			92	10
50845110333	5084511 VDE	PH 3			94	10
50845120133	5084512 VDE		PZ 1		60	10
50845120233	5084512 VDE		PZ 2		90	10
50845120333	5084512 VDE		PZ 3		92	10
50845367533	5084536 VDE			0,5 x 2,5 x 75 mm	54	10
50845361033	5084536 VDE			0,8 x 4,0 x 100 mm	80	10
50845361233	5084536 VDE			1,0 x 5,5 x 125 mm	82	5

**5084550 -
VDE**



VDE Schraubendreher-Satz, 6-tlg.

2K-VDE-Schraubendreher nach IEC 60900 : 2004/VDE 006282 Teil 201 (DIN 7437 u. DIN 7438 PZ), ergonomischer Softgriff, Klingen aus Chrom-Vanadium-Stahl, gehärtet, geschwärzt und mit umspritzter Klingenisolierung

Tournevis VDE, 6 pcs.

Tournevis VDE à 2 composantes suivant IEC 60900 : 2004/VDE 006282 Section 201 (DIN 7437 et DIN 7438 PZ), poignée souple ergonomique au chrome vanadium, trempée, brunie et avec isolation de la tige par injection

VDE Schroevendraaier-set, 6 delig

2 componenten VDE schroevendraaier volgens IEC 60900 : 2004/VDE 006282 deel 201 (DIN 7437 et DIN 7438 PZ), ergonomische soft grip. Klingen uit chroom-vanadiumstaal, gehard, gezwart en met omspoten klingisolatie



Bestell-No./Order-No.	Art. No.	⊖	*	g	
50845500033	5084550 VDE		PZ 1 PZ 2	490	1
		0,5 x 2,5 x 75 mm			
		0,8 x 4,0 x 100 mm			
		1,0 x 5,5 x 125 mm			
		Spannungsprüfer/Voltage tester			
		0,75 x 3,0 x 60 mm			

5081424



Spannungsprüfer
150 - 250 Volt,
vollisoliert

Vernikkelte Klinge,
transparenter Griff

Détecteurs de tension
150 - 250 volt,
isolation totale

Poignée transparente nickelée
fente

Spanningzoeker
150 - 250 volt,
volledig geïsoleerd

Vernikkelde kling,
transparente greep



Bestell-No./Order-No.	Art. No.			
50814240050	5081424	0,75 x 3,0 x 60 mm	20	10

50839 - VDE



VDE Einmaulschlüssel,
verstellbar, DIN 3117

Chrom-Vanadium, verchromt mit
schutzisoliertem Griff nach
DIN EN 60900 und Skala

VDE Clés à molette,
DIN 3117

Chrome-Vanadium, chromé,
avec poignée isolé conforme
norme EN 60900

VDE verstelbare moers-
leutel, DIN 3117

Chroom-Vanadium, verchromd,
met geïsoleerde greep volgens DIN
EN 60900 en schaal aanduiding



Bestell-No./Order-No.	Art. No.	mm		
50839001088	50839 - VDE	255	10	5

5081221

Automatische
Abisolierzange

Zum Abisolieren von Elektro-
drähten, Litzenleitern und Kabeln,
Abisolierbereich PVC-isolierte
Leiter 0,2 - 6 mm² Querschnitt,
einstellbare Abisolierlänge bis
18 mm, Drahtschneider bis 4 mm²

Pince à dénuder
automatique

Pour le décapage de fils
électriques, fils torsadés et câbles,
pour les câbles isolés au PVC de
0,2 à 6 mm² de section, pince à
dénuder réglable jusque 18 mm,
parfaite isolation grâce à l'auto-
matique ajustement de l'épaisseur
d'isolation, coupe-fils jusqu'à
4 mm²

Automatische
kabelstriptang

Voor strippen van elctradraad
en kabels, bereik pvc geïsoleerde
draad 0,2 - 6 mm² doorsnede,
instelbare striplengte tot 18 mm,
draadknipper tot 4 mm²



Bestell-No./Order-No.	Art. No.		
50812211900	5081221	200	1

5081668

Kabel-Klappmesser

Mit 2-K Griff, für schnelle Kabel- und Drahtabsolierung, rostfreie Klinge

Couteau d'électricien

Avec manche en plastique 2-K pour décapage rapide des fils et câbles, lame d'acier inoxydable

Inklapbaar kabelmes

Met 2 componenten greep, voor snel kabel- en draadstrippen, rvs lemmet

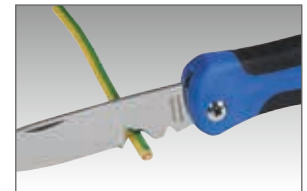

Bestell-No./Order-No.	Art. No.	 mm		
50816680000	5081668	115 - 195	75	1



5081835

Wasserwaage

Aus 2-K Kunststoff mit Schutz durch Weichkomponente und Aluminiumsockelleiste, magnetisch, für eine exakte Auflage. Libellen für waagrecht, senkrecht und 45° Messungen. Prismatische Messfläche.

Niveau d'eau

En plastique à 2 composants avec protection par matières souples et profil en aluminium, magnétique, pour un appui précis, Niveau à bulle d'air pour mesure horizontale, verticale et à 45°, Surface de mesure prismatique.

Waterpas

Van 2 componenten kunststof met bescherming door soft componenten en aluminium bodemstrip, magnetisch. Libel voor horizontale, verticale en 45° metingen prismatisch meetoppervlak.



Bestell-No./Order-No.	Art. No.	mm		
5081835000	5081835	230	110	1

5081835-1

Wasserwaage, 400 mm

3 Libellen
Starkes Alu-Rechteckprofil mit Verstärkungsrippen, Pulverbeschichtung, Stoßdämpfende Endkappen und Messskala

Niveau d'eau, 400 mm

3 fioles
Profil fort rectangulaire au nervures de renfort rectangulaire. Revêtement de poudres, embouts anti-choc, tableau de mesure.

Waterpas, 400 mm

3 libellen
Robuust aluminium kokerprofiel met versterkingsribben, poedercoating, schokabsorberende einkappen en maatverdeling.



Bestell-No./Order-No.	Art. No.	mm		
50818350100	5081835-1	400	250	1

5081669

Cuttermesser, 18 mm

Aus 2-K Kunststoff, mit Feststellrad und integriertem Klingemagazin, selbstladend, 5-fach bestückt, inkl. Klingendreher und Bleistiftanspitzer



Cutter, 18 mm

En plastique à 2 composants, avec chargeur de 5 lames, casse-lame et taille-crayon inclus

Breekmes, 18 mm

Van 2 componenten kunststof, met automatische vergrendeling en geïntegreerd magazijn voor reserve messen, zelfladend, incl. 5 messen, met mesbreker en puntenslijper



Bestell-No./Order-No.	Art. No.	 mm		
50816690000	5081669	170	147	1
*50816691200	5081669-12	170	2093	12

*Lieferung im Verkaufsdisplay • Delivery in sale display • Livraison en présentoirs

5081836

Zimmermannswinkel

- Hochwertiger Zimmermannswinkel aus Aluminium mit Lineal aus rostfreiem Stahl
- Skalierung:
 - Vorderseite in mm (300)
 - Rückseite in Zoll (11,8)
- Praktische Bohrung zum Aufhängen (8 mm)
- Anschlagschenkel mit Gehrung zum Anreißen von 45° und 90° Linien

Equerre de menuisier

- Equerre de menuisier de haute qualité en aluminium avec règle en acier inoxydable
- Graduation:
 - Face en mm (300)
 - Dos en pouces (11,8)
- Alésage (8mm) pour suspendre
- Poignée intégrée angle 45° pour marquage facile de lignes à 45° et 90°

Schrijfhaak

- Hoogwaardige aluminium schrijfhaak met rvs lineaal
- Schaalverdeling:
 - Voorzijde in mm (300)
 - Achterzijde in inch (11,8)
- Met praktisch ophangoog
- Handgreep met geïntegreerde 45° hoek voor het eenvoudig aangeven van 45° en 90° lijnen



Bestell-No./Order-No.	Art. No.	 mm / "		
50818360000	5081836	300 / 11,8	250	1

5081839-3

Bandmaß, 3 m

- ABS Kunststoff Gehäuse
- Softgrip Gummibeschichtung für sicheren Halt
- Magnetischer Endhaken, verschiebbar für Innen- und Außenmessung
- Stopfunktion
- Gürtelclip
- Handschleufe

Mesure de poche, 3 m

- Boîtier en plastique ABS
- Revêtement souple de la poignée en caoutchouc pour une bonne prise en main
- Crochet magnétique, réglable pour mesure intérieure et extérieure
- Fonction d'arrêt
- Clip ceinture
- Bandoulière

3 meter rolbandmaat

- ABS kunststof huis
- Softgrip rubberen mantel voor stevige grip
- Magnetische haak, verstelbaar voor binnen- en buitenmeting
- Stopfunctie
- Riemclip
- Polskoord



Bestell-No./Order-No.	Art. No.	Messbereich · Measuring range		
50818393000	5081839-3	3 m	125	1
*50818393200	5081839-12	3 m	1500	12

*Lieferung im Verkaufdisplay • Delivery in sale display • Livraison en présentoirs

5081675-79

Werkstattfeilen

Hieb 2, mit ergonomischem 2-K Softgriff und integrierten Aufhängeösen

Limes d'atelier

Avec poignée ergonomique souple à 2 composantes et trou de suspension inclus

Werkplaatsvijlenset

Halfzoet, met ergonomische 2 componenten soft-grip en geïntegreerd ophangoog



Bestell-No./Order-No.	Art. No.				
50816752000	5081675		200 mm	220	1
50816762000	5081676		200	220	1
50816772000	5081677		200	220	1
50816782000	5081678		200	220	1
50816792000	5081679		200	220	1

5081680

Werkstattfeilen-Satz

Hieb 2, 5-tlg. 8"/200 mm
in Rolltasche mit Aufhängeösen

Jeu de limes d'atelier

5 pcs. 8"/200 mm en trousse
avec trou de suspension

Werkplaatsvijlenset

Halfzoet, 5 delig 8"/200 mm
in rolltas met ophangogen



Bestell-No./Order-No.	Art. No.	Ø mm		
50816800500	5081680	200	1100	1

5081440

Werkzeugsatz mit Meißel, Körner, Splint- und Durchtreiber

In klappbarer Metallkassette







Composition de burins, bédanes et chasse-clous

En boîte métallique, repliable

Gereedschapset met beitels, centerpunt, pendrijver en doorslagen

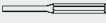
In metalen cassette

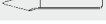

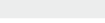
Bestell-No./Order-No.	Art. No.	enthaltend · containing · composition			
50814400000	5081440	1	 Ø 3 x 120 mm	715	1
		1	 Ø 5 x 150 mm		
		1	 Ø 3 x 120 mm		
		1	 5 x 130 mm		
		2	 12 x 130 mm		
			 14 x 150 mm		

50830

Splinttreibersatz

In klappbarer Metallkassette

Jeux de chasse-goupilles

En boîte métallique, repliable

Pendrijverset

In metalen cassette



Bestell-No./Order-No.	Art. No.	enthaltend · containing · composition		
5083000000	50830	6 Ø 3 / 4 / 5 / 6 / 7 / 8 x 150 mm	690	1

5082250

**Multifunktions-
Abziehersatz
in Kunststoffbox**

Grundplatte aus Spezialguß, Abzugsarme und Spindel aus Chrom-Molybdän-Stahl, patentierte Rasterfunktion, verwendbar als 2- und 3-armige Innen-/Außenabzieher in 8 Varianten, Belastung als 2-armiger Abzieher: 25000 N - VPA getestet

1 Abzieherbrücke
1 Gewindespindel
Je 3 Abzieharme

Jeu d'extracteurs multifonctions en coffret plastique

Support en fonte spéciale, bras extracteurs et axe en acier au chrome-molybdène, fonction crantée brevetée, utilisable en 8 variantes avec 2 ou 3 bras en prise extérieure ou intérieure stabilité sous charge 25000 N - VPA testé

1 Portique de support
1 Axe fileté
3 bras extracteurs de chaque

Multifunctionele trekkerset in kunststof koffer

Brug van speciaal gietijzer, haken en spindel van chroom-molybdeenstaal, gepatenteerde karteloverbrenging, te gebruiken als 2- en 3- armige binnen-/buitentrekker in 8 varianten belasting als 2-armige trekker: 25000 N - VPA getest

1 Trekkerbrug
1 Draadspindel
elk 3 trekhaken

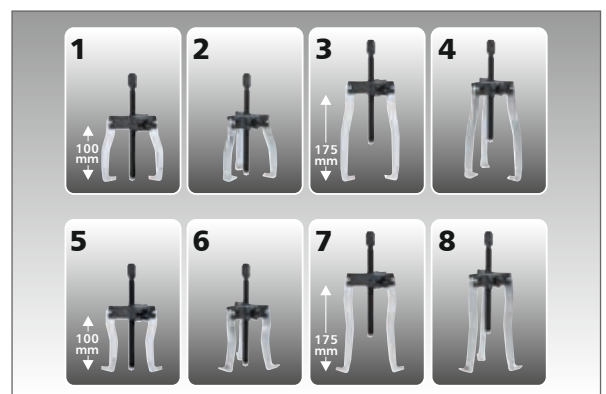

Bestell-No./Order-No.	Art. No.			
50822500780	5082250		2635	1

HSS-Gewindeschneid-
satz

Chrom-Vanadium, verchromt,
in Metallkasten, mit 2-K
Schaumstoffeinlagen, 16-tlg.

Assortiment filières HSS

Chrome-Vanadium, chromées,
en coffret métallique, avec intérieur
mousse à 2 composantes, 16 pces.

HSS tap- en draadsnijset

Chroom-Vanadium, verchromd, in
metalen kist, met 2 componenten
schuimleg, 16 delig



Bestell-No./Order-No.	Art. No.	Maße · Dimensions		
5081490000	5081490	220 x 110 x 45 mm	435	1

Ersatzteile

Pièces de rechange

Onderdelen



Bestell-No./Order-No.	Art. No.	Maße · Dimensions		
50814922000	5081492-20	M3 - M12	149	1
50814912000	5081491-20	M3 - M8	52	1
50814913000	5081491-30	M5 - M12	83	1
50814910400	5081491-04	M4	5	1
50814910500	5081491-05	M5	6	1
50814910600	5081491-06	M6	10	1
50814910800	5081491-08	M8	16	1
50814911000	5081491-10	M10	23	1
50814920400	5081492-04	M4	26	1
50814920500	5081492-05	M5	26	1
50814920600	5081492-06	M6	24	1
50814920800	5081492-08	M8	22	1
50814921000	5081492-10	M10	20	1
50825018083	50825-00-18	\square 1/4"	146	5

50834



Feinmechaniker-Bitsatz, 31-tlg.

Chrom-Vanadium, verchromt,
in Kunststoffbox. 5/32" Aufnahme.

Embouts de précision,
31 pces.

Chrome-Vanadium, chromées,
en coffret plastique. 5/32"

Precisie bitset,
31 delig

Chroom-Vanadium, verchromd,
in kunststof koffer. 5/32"



enthaltend/containing/composition

	144 mm / 5/32"
	PH 000 / 00 / 0 / 1
	PZ 0 / 1
	0,7 / 0,9 / 1,3 / 1,5 / 2 / 2,5 / 3 / 4
	1 / 1,5 / 2 / 2,5 / 3 / 3,5 / 4
	TX 4 / 5 / 6 / 7 / 8 / 9 / 10 / 15 / 20

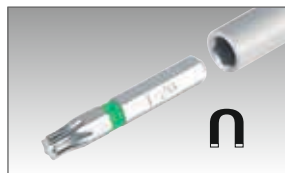

Bestell-No./Order-No.	Art. No.	Maße · Dimensions		
5083400000	50834	155 x 105 x 40 mm	396	1

Ersatzteile 5/32"

Pièces de rechange 5/32"

Onderdelen 5/32"



50834-32



50834-35



50834-31



50834-30



50834-37

Bestell-No./Order-No.	Art. No.	Maße · Dimensions		
50834000100	50834-1	144 mm / 5/32"	47	1
50834320400	50834-32	PH 000/00/0/1	16	1
50834350200	50834-35	PZ 0/1	5	1
50834310800	50834-31	0,7/0,9/1,3/1,5/2/2,5/3/4	41	1
50834300700	50834-30	1/1,5/2/2,5/3/3,5/4	10	1
50834370900	50834-37	TX 4/5/6/7/8/9/10/15/20	21	1

50835



Feinmechaniker-Schraubendrehersatz, 16-tlg.

In Rolltasche. 2-K Schraubendreher nach DIN 5265 / 8764. Ergonomischer Softgriff mit drehbarer Kappe. Klingen aus Chrom-Molybdän-Stahl, gehärtet und geschwärzt.

Jeu de tournevis de mécanicien de haute précision, 16 pces.

En trousse. Tournevis 2 composants conforme DIN 5265 / 8764. Manche softgrip ergonomique avec embout rotatif. Lames acier Chrom-Molybdène trempés et noirci.

Precisie schroevendraaierset 16 delig

In rolltas. 2 componenten schroevendraaiers volgens DIN 5265 / 8764. Ergonomische softgrip met draibare kap. Klingen uit chroom-molybdeen staal, gehard en gezwart.



enthaltend/containing/composition

	PH 000 / 00 / 0
	0,9 / 1,5 / 2 / 2,5 / 3
	1,5 / 2 / 2,5
	TX 4 / 5 / 6 / 7 / 8



Magnetisierer/Entmagnetisierer
Magnétiseur/Démagnétiseur
Magnetisieren en demagnetiseren



siehe Seite 150
voir page 150
zie pagina 150

Bestell-No./Order-No.	Art. No.	Maße · Dimensions		
50835000000	50835	230 x 115 x 50 mm	420	1



100% Kundenzufriedenheit

So urteilen unsere Anwender:

„Die Kartuschenpresse ist sehr sauber ausgeführt und alles macht einen sehr wertigen, gut verarbeiteten Eindruck.“

„Die Kartuschenpresse ist stabil! Die Kartuschen verwinden nicht mehr! Der Pressvorgang ist kinderleicht und ermüdungsfrei!“

„Ich bin begeistert und gebe eine klare Kaufempfehlung für die HEYTEC Profi Kartuschenpresse Multipower ab.“

„Als alter Profi und Handwerker kann ich dieses Teil guten Gewissens weiterempfehlen. Alles geht spielerisch leicht, man muß nur wenig Druck ausüben (könnte ein dreijähriges Kind bedienen), und die Stabilität ist top.“

100% Customer satisfaction

Here's what our customers say:

„This caulking gun is very well made and leaves an impression of very high quality.“

„The caulking gun is sturdy! Cartridges don't twist anymore! Pressing is a breeze and fatigue-proof!“

„I'm really impressed and support a clear buying recommendation for the HEYTEC profi caulking gun.“

„As an experienced professional and craftsman I can recommend this item in good conscience. Operation is a breeze and only little pressure must be applied (could be done by a three-year-old child). Stability is top-notch!“



Profi-Kartuschenpistole Multipower

Weitere Informationen
zum Produkt siehe Seite 162

Profi caulking gun multipower

For further product information
see page 162

**5084511 -
5084530**



**2-K Werkstatt-
Schraubendreher**

2-K Schraubendreher nach
DIN 5265 / 8764.
Ergonomischer Softgriff.
Klinge aus Chrom-Molybdän-Stahl,
gehärtet und geschwärzt

**Tournevis d'atelier à
2 composantes**

Tournevis à 2 composantes suivant
DIN 5265 / 8764, poignée
souple ergonomique, tige au
chrome-molybdène, trempée et
embout bruni

**2 Componenten werk-
plaats schroevendraaier**

2 componenten schroevendraaier
volgens DIN 5265 / 8764,
ergonomische soft-grip, kling uit
chrom-molybdeenstaal, gehard
en gezwart



Bestell-No./Order-No.	Art. No.	⊖	+	✦	g	⊞
50845110180	5084511		PH 1		60	10
50845110280	5084511		PH 2		100	10
50845120180	5084512			PZ 1	60	10
50845120280	5084512			PZ 2	100	10
50845300480	5084530	0,8 x 4,0 x 75 mm			40	10
50845305580	5084530	1,0 x 5,5 x 125 mm			80	5
50845306580	5084530	1,2 x 6,5 x 150 mm			100	5

5084564



**2-K Werkstatt-
Schraubendreher-Satz,
5-tlg.**

2-K Schraubendreher nach
DIN 5265 / 8764.
Ergonomischer Softgriff.
Klinge aus Chrom-Molybdän-Stahl,
gehärtet und geschwärzt

**Tournevis d'atelier à
2 composantes, 5 pces.**

Tournevis à 2 composantes suivant
DIN 5265 / 8764, poignée
souple ergonomique, tige au
chrome-molybdène, trempée et
embout bruni

**2 Componenten werk-
plaats schroevendraaier-
set, 5 delig**

2 componenten schroevendraaier
volgens DIN 5265 / 8764,
ergonomische soft-grip, kling uit
chrom-molybdeenstaal, gehard
en gezwart



Bestell-No./Order-No.	Art. No.	⊖	+	g	⊞
50845640080	5084564		PH 1 PH 2	460	1
		0,8 x 4,0 x 75 mm			
		1,0 x 5,5 x 125 mm			
		1,2 x 6,5 x 150 mm			

5084515



TORX®-Schraubendreher

2-K Schraubendreher nach DIN 5265 / 8764. Ergonomischer Softgriff. Klinge aus Chrom-Molybdän-Stahl, gehärtet und geschwärzt

TORX®-Tournevis

Tournevis à 2 composantes suivant DIN 5265 / 8764, poignée souple ergonomique, tige au chrome-molybdène, trempée et embout bruni

TORX® schroevendraaier

2 componenten schroevendraaier volgens DIN 5265 / 8764, ergonomische soft-grip, kling uit chroom-molybdeenstaal, gehard en gezwart



Bestell-No./Order-No.	Art. No.			
50845151080	5084515	T 10	63	10
50845151580	5084515	T 15	63	10
50845152080	5084515	T 20	63	10
50845152580	5084515	T 25	87	5
50845152780	5084515	T 27	87	5
50845153080	5084515	T 30	87	5
50845154080	5084515	T 40	97	5

5084560



TORX®-Schraubendreher-Satz, 7-tlg.

2-K Schraubendreher nach DIN 5265 / 8764. Ergonomischer Softgriff. Klinge aus Chrom-Molybdän-Stahl, gehärtet und geschwärzt

Jeu de tournevis TORX®, 7 pcs.

Tournevis à 2 composantes suivant DIN 5265 / 8764, poignée souple ergonomique, tige au chrome-molybdène, trempée et embout bruni

TORX® schroevendraaier set, 7 delig

2 componenten schroevendraaier volgens DIN 5265 / 8764, ergonomische soft-grip, kling uit chroom-molybdeenstaal, gehard en gezwart



Bestell-No./Order-No.	Art. No.			
50845600080	5084560	T 10	680	1
		T 15		
		T 20		
		T 25		
		T 27		
		T 30		
		T 40		

5083301-1

Magnet Bithalter

- Chrom-Molybdän, verchromt
- Mit 2-K Kunststoffgriff
- Mit Dauermagnet
- Sicherheitsarretierung durch Dauermagnet und formschlüssige Arretierung
- Einfache Entnahme durch Auswurfbetätigung
- Extrem schmale Ausführung
- Ideal geeignet für enge, schwer zugängliche Stellen

Adaptateur magnétique pour embouts

- Chrome-molybdène, chromées
- Avec poignée ergonomique souple à 2 composantes
- Aimant permanent
- Verrouillage de sécurité par l'aimant permanent et verrouillage positif
- Démontage facile par opération d'éjection
- Design ultra mince
- Idéal pour des endroits serrés et difficiles à atteindre

Bitadapter

- Chrom-molybdeenstaal, verchromd
- Met permanente magneet
- Bit blijft op zijn plek dankzij permanente magneet en minimale speling tussen bit en bithouder
- Eenvoudig uitnemen van de bit door uitwerpmechanisme
- Extreem smalle uitvoering
- Ideaal voor nauwe, moeilijk bereikbare plaatsen



Bestell-No./Order-No.	Art. No.	CLD mm	g	
50833010080	5083301-1	200	240	1

5080542



Steckschlüssel

Mit Quergriff und Aufhängebohrung, für Aussensechskantschrauben, Spezial Stahl

Douilles

Avec poignées en T et trou de suspension pour vis hexagonales ext. acier spécial

Dopschroevendraaier

Met T-greep en ophangoog, voor zeskantbouten, speciaal staal

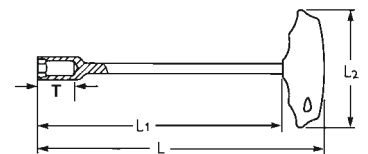

Bestell-No./Order-No.	MM	CLD mm	L1 mm	L2 mm	T mm	g	
50805425580	5,5	260	230	95	21,0	104	5
50805420680	6	260	230	95	21,0	106	5
50805420780	7	260	230	95	21,0	107	5
50805420880	8	270	230	115	26,0	236	5
50805420980	9	270	230	115	26,0	240	5
50805421080	10	270	230	115	26,0	242	5
50805421180	11	270	230	115	26,0	248	5
50805421280	12	270	230	115	26,0	252	5
50805421380	13	270	230	115	26,0	262	5

R 5080542-9



**Steckschlüsselsatz,
9-tlg.**

In Polyesterrolltasche, mit Textil-
bindeschleifen und Aufhängeösen

**Jeux de douilles,
9 pces.**

Trousse en polyester avec lanière
textile et oeillet de suspension

**Dopschroevendraaierset,
9 delig**

In polyester rolltas, met sluitriemen
en ophangogen



enthaltend/containing/composition



MM 5,5/6/7/8/9/10/11/12/13

Bestell-No./Order-No.	Art. No.		
50805429080	R 5080542-9	2635	1

5081338



**Sechskant-
Schraubendreher**

Mit Quergriff und Aufhänge-
bohrung, für Innensechskant-
schrauben, Spezial Stahl

Tournevis hexagonal

Avec poignées en T et trou de
suspension pour vis hexagonales
ext. acier spécial

Stiftsleutel zeskant

Met T-greep en ophangoog,
voor binnenzeskantbouten,
speciaal staal

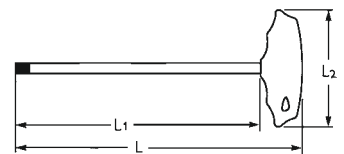

Bestell-No./Order-No.	MM	mm	L1 mm	L2 mm		
50813380280	2	130	100	75	19	5
50813382580	2,5	130	100	75	21	5
50813380380	3	130	100	75	23	5
50813380480	4	180	150	75	35	5
50813380580	5	180	150	95	65	5
50813380680	6	185	150	95	79	5
50813380880	8	230	200	95	135	5
50813381080	10	240	200	115	225	5

H 5081338-8



Sechskant-Schraubendrehersatz

Im Metallhalter
170 x 120 x 245 mm,
8-tlg., mit Aufhängebohrungen,
Spezial Stahl

Jeu de tournevis
hexagonaux

Avec support en métal
170 x 120 x 245 mm,
8 pcs., avec trou de suspension,
acier spécial

Stiftsleutelset zeskant met
T-greep

In metalen standaard
170 x 120 x 245 mm,
8 delig, met ophangogen,
speciaal staal



Bestell-No./Order-No.	Art. No.	MM		
5081338080	H 5081338-8	2/2,5/3/4/5/6/8/10	920	1

H 5081340-7



Winkelschraubendrehersatz

Im Handklapphalter, kunststoff-
beschichtet, für Innensechskant-
schrauben, Spezial Stahl
Lieferung in Blisterverpackung

Jeu de clés mâles
coudées

Sur monture, revêtement plastique,
pour vis à 6 pans creux,
acier spécial
Livré sous blister

Stiftsleutelset

Zakmesmodel, kunststof houder,
voor binnenzeskant bouten,
speciaal staal
Op blister



Bestell-No./Order-No.	Art. No.	MM		
50813406280	5081340-7	1,5/2/2,5/3/4/5/6	134	5

HP 5081343-9



Kugelpf-Winkel-schraubendrehersatz

9-tlg., im Kunststoffhalter, für schwer zugängliche Innensechskantschrauben, Spezial Stahl
Lieferung in Blisterverpackung

Jeu de clés mâles coudées à tête sphérique

9 pces., sur monture plastique, pour vis 6 pans creux avec accès difficile, acier spécial
Livré sous blister

Stiftsleutelset kogelkop

9 delig, in kunststof houder, voor moeilijk bereikbare binnenzeskant bouten, speciaal staal
Op blister

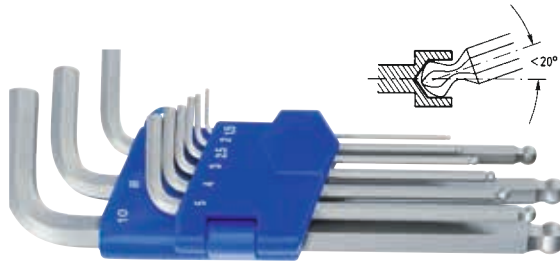

Bestell-No./Order-No.	Art. No.	MM	\varnothing mm	$\frac{g}{g}$	
50813438280	HP 5081343-9	1,5/2/2,5/3/4/5/6/8/10	185	353	5

HP 5081344-9



Kugelpf-Winkel-schraubendrehersatz, lang

9-tlg., im Kunststoffhalter, für schwer zugängliche Innensechskantschrauben, Spezial Stahl
Lieferung in Blisterverpackung

Jeu de clés mâles coudées à tête sphérique, long

9 pces., sur monture plastique, pour vis 6 pans creux avec accès difficile, acier spécial
Livré sous blister

Stiftsleutelset kogelkop

9 delig, in kunststof houder, voor moeilijk bereikbare binnenzeskant bouten, speciaal staal
Op blister

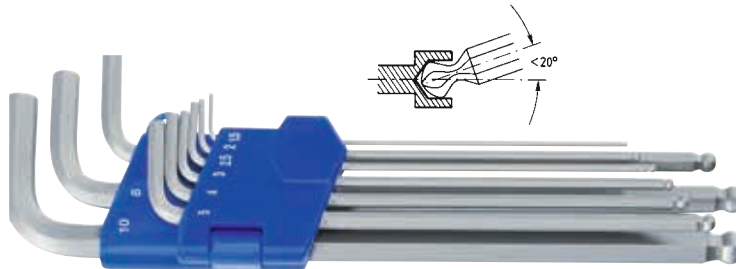

Bestell-No./Order-No.	Art. No.	MM	\varnothing mm	$\frac{g}{g}$	
50813448280	HP 5081344-9	1,5/2/2,5/3/4/5/6/8/10	235	470	5

5081347



TORX®-Schraubendreher

Mit Quergriff und Aufhängebohrung, für Innen-TORX®-Schrauben, Spezial Stahl

Tournevis TORX®

Avec poignées en T et trou de suspension pour vis TORX intérieures, acier spécial

TORX® schroevendraaier

Met T-greep en ophangoog voor binnen TORX® bouten, speciaal staal

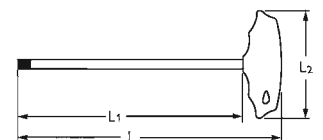

Bestell-No./Order-No.		mm	\varnothing mm	L1 mm	L2 mm	$\frac{g}{g}$	
50813471080	T 10	2,74	125	100	75	27	5
50813471580	T 15	3,27	125	100	75	28	5
50813472080	T 20	3,86	125	100	75	28	5
50813472580	T 25	4,43	130	100	95	62	5
50813472780	T 27	4,99	130	100	95	63	5
50813473080	T 30	5,52	235	200	95	85	5
50813474080	T 40	6,65	235	200	95	123	5
50813474580	T 45	7,82	285	250	95	142	5
50813475080	T 50	8,83	290	250	115	315	5

H 5081347-9



**TORX®
Schraubendrehersatz**

Im Metallhalter
195 x 120 x 290 mm,
9-tlg., mit Aufhängebohrungen,
Spezial Stahl

Jeu de tournevis TORX®

En coffret métallique
195 x 120 x 290 mm,
9 pcs., avec trou de suspension,
acier spécial

TORX® schroevendraaier-
set met T-greep

In metalen standaard
195 x 120 x 290 mm,
9 delig, met ophangogen,
speciaal staal



Bestell-No./Order-No.	Art. No.			
50813470080	5081347-9	T 10/T 15/T 20/T 25/T 27 T 30/T 40/T 45/T 50	1245	1

H 5081348-7



**TORX®
Winkelschraubend-
drehersatz**

Im Handklapphalter, kunststoff-
beschichtet, für Innen-TORX®-
Schrauben, Spezial Stahl
Lieferung in Blisterverpackung

Jeu de tournevis
TORX® coudés

Sur monture, revêtement plastique,
pour vis TORX intérieures,
acier spécial
Livré sous blister

TORX® schroevendraaier-
set

Zakmesmodel, kunststof houder,
voor binnen TORX® bouten,
speciaal staal
Op blister



Bestell-No./Order-No.	Art. No.			
50813486280	5081348-7	T 10/T 15/T 20/T 25/T 27/T 30/T 40	245	1

HP 5081348-9



**TORX®
Winkelschraubendrehersatz**

9-tlg., im Kunststoffhalter,
für Innen-TORX®-Schrauben,
Spezial Stahl
Lieferung in Blisterverpackung

Jeu de tournevis
TORX® coudés

9 pces., sur monture plastique,
pour vis TORX intérieures,
acier spécial
Livré sous blister

TORX® schroevendraaierset

9 delig, in kunststof houder,
voor binnen TORX® bouten,
speciaal staal
Op blister

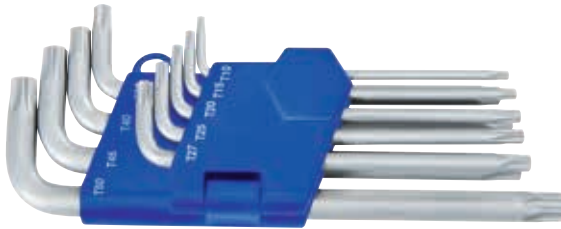

Bestell-No./Order-No.	Art. No.		mm		
5081348280	5081348-9	T 10/T 15/T 20/T 25/T 27 T 30/T 40/T 45/T 50	160	316	1

HP 5081349-9



**TORX®
Winkelschraubendrehersatz, lang**

9-tlg., im Kunststoffhalter,
für Innen-TORX®-Schrauben,
Spezial Stahl
Lieferung in Blisterverpackung

Jeu de tournevis
TORX® coudés, long

9 pces., sur monture plastique,
pour vis TORX intérieures,
acier spécial
Livré sous blister

TORX® schroevendraaierset

9 delig, in kunststof houder,
voor binnen TORX® bouten,
speciaal staal
Op blister

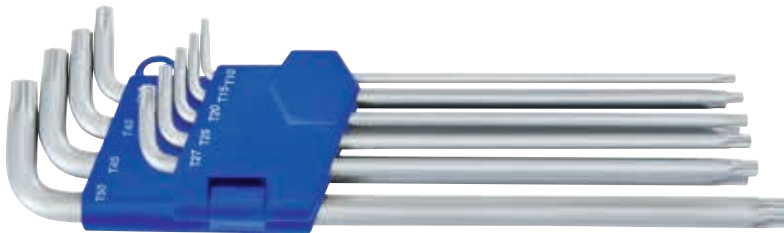

Bestell-No./Order-No.	Art. No.		mm		
5081349280	5081349-9	T 10/T 15/T 20/T 25/T 27 T 30/T 40/T 45/T 50	235	480	1

508339

**Magnetisierer und
Entmagnetisierer**

Zuverlässiges Entmagnetisieren
und Magnetisieren von Schraubendreherklingen, vereinfacht das Ein- + Ausdrehen von Schrauben an schwer zugänglichen Stellen, zum sicheren Arbeiten an empfindlichen elektronischen Bauteilen

Magnétiseur et
Demagnétiseur

Démagnétisation et magnétisation fiable de lames de tournevis, simplifie le vissage et le dévissage des vis dans les zones difficiles à atteindre, pour travailler en toute sécurité sur les composantes électroniques sensibles

Magnetiseren en
demagnetiseren

Betrouwbaar demagnetiseren en magnetiseren van schroevendraaiersklingen, vereenvoudigt het in- en uitdraaien van schroeven op moeilijk bereikbare plaatsen, voor het veilig werken bij statisch gevoelige elektronische componenten



Bestell-No./Order-No.	Art. No.	Maße · Dimensions		
5083390000	508339	52 x 50 x 29 mm	88	1

**5081523 -
5081525**

Schlosserhämmer

Fiberglasstiel mit Kunststoff-Schutzüberzug, Kopf schwarz lackiert

Marteaux de mécanicien

Manche en fibre de verre avec protection plastique, tête laquée noir

Bankhamers

Glasfiber steel met kunststof mantel, kop zwart gelakt



Bestell-No./Order-No.	Art. No.	g	mm	g	
50815230021	5081523	300	315	500	5
50815250021	5081525	500	340	700	5

5081518

Fäustel

Fiberglasstiel mit Kunststoff-Schutzüberzug, Kopf schwarz lackiert

Masse

Manche en fibre de verre avec protection plastique tête laquée noir

Vuisthamer

Glasfiber steel met kunststof mantel, kop zwart gelakt



Bestell-No./Order-No.	Art. No.	g	mm	g	
50815181021	5081518	1000	260	1290	1

5081516-1

Latthammer

Kopf schwarz lackiert, mit kariert-gefräster Bahn, eingeschmiedetes Nagelbett mit Magnethalterung, 2-K Kunststoffgriff

Marteau de charpentier

Tête laquée noire, avec face fraisée en gaufrage, glissière pour clou incorporée et forgée, avec maintien magnétique, pignée à 2 composantes

Lattenhamer

Met zwart gelakte, geribbelde kop, ingesmede magnetische spijkerhouder, 2 componenten kunststof greep



Bestell-No./Order-No.	Art. No.	g	mm	g	
50815160120	5081516-1	600	315	841	1

5081516

Ganzstahl-Latthammer

Mit kariert-gefräster Bahn, eingeschmiedetes Nagelbett mit Magnethalterung, 2-K Kunststoffgriff, Kunststoffschutzkappe an der Pinne

Marteau de charpentier tout acier

Avec face fraisée en gaufrage glissière pour clou incorporée et forgée avec maintien magnétique, poignée à 2 composantes, pointe protégée par un manchon en plastique

Geheel stalen lattenhamer

Met geribbelde kop, ingesmede magnetische spijkerhouder, 2 componenten kunststof greep, kunststof beschermkap op de pinne



Bestell-No./Order-No.	Art. No.				
		g	mm	g	
50815160021	5081516	600	330	925	1

5081530

Kunststoff - Schonhammer

Hickory-Stiel, auswechselbare Köpfe in 2 Härten; Shore D66~85; Shore D45±5

Massettes avec embouts en plastique

Poignée hickory, tête interchangeable en 2 duretés; Shore D66~85; Shore D45±5

Kunststof hamer

Hickory steel, verwisselbare koppen in 2 hardheden; Shore D66~85; Shore D45±5



Bestell-No./Order-No.	Art. No.				
		Ø	mm	g	
50815302700	5081530-27	27	270	278	2
50815303500	5081530-35	35	300	390	2

5081531

Ersatzköpfe Kunststoff

Standardmäßig aus Kunststoff (Celluloseacetat) für Kunststoff - Schonhammer, Härte nach Shore D 66±5

Embouts de rechange en plastique

Standard, en plastique (acétocellulose) pour massettes, Shore D 66±5

Reservedoppen uit kunststof

Standaard, uit kunststof (celluloseacetat) voor kunststof hamers, hardheid volgens Shore D 66±5



Bestell-No./Order-No.	Art. No.				
		Ø		g	
50815312700	5081531-27	27		18	10
50815313500	5081531-35	35		23	10

5081532

Ersatzköpfe Nylon

Standardmäßig aus schlagfestem Nylon, Härte nach Shore D 45±5

Embouts de nylon interchangeables

Standard, en nylon, Shore D 45±5

Reservedoppen nylon

Standaard, uit slagvast nylon, hardheid volgens Shore D 45±5



Bestell-No./Order-No.	Art. No.				
		Ø		g	
50815322700	5081532-27	27		12	10
50815323500	5081532-35	35		23	10

9088070

Werkzeugrolltasche, leer

Rolltasche mit 15 Facheinteilungen, gefertigt aus schwarzem Polyester, PP-Einfassung in dunkelblau, mit Gurt und Schnalle. Ohne Aufdruck.

Trousse à outils, vides

Trousse, sans outils, à 15 compartiments, en polyester noir, bords bleu foncé avec lanière et boucle, sans impression

Gereedschapsroltas, leeg

roltas, zonder inhoud, met 15 vakken, vervaardigd uit zwart polyester, donkerblauwe PP afwerkrand, met sluitriem en gesp. Zonder opdruk.



Bestell-No./Order-No.	Art. No.	Maße · Dimensions	g	
90880701500	9088070	670 x 340 mm	750	5

50890-30

Haushalts-Werkzeugtasche, 8-tlg.

Zusammenstellung der gebräuchlichsten Qualitätswerkzeuge für Haushalt und Büro; für zuhause oder unterwegs. Praktisch und platzsparend, Kunstledertasche mit Verschluss. Optimal auch in der Werbebranche einsetzbar.

Trousse d'outillage à usage domestique, 8 pces.

Composition d'outillage de qualité pour l'entretien de la maison, du bureau à domicile ou en voyage. Rangés en trousse similicuir pratique et compacte, avec fermoir. Optimal aussi dans le domaine des cadeaux d'affaires.

Gereedschapsset voor thuis, 8 delig

Overzicht van de meest algemene kwaliteitsgereedschappen voor gebruik in en om huis en kantoor; voor thuis en onderweg. Praktisch en plaatsbesparend, verpakt in kunstleder tas met sluiting. Ook uitstekend geschikt als reclameobject.



enthaltend/containing/composition	
	200 mm
	300 g
	255 mm
	230 mm
	250 mm
	170 mm
	6,5 mm x PH 2
	150 - 250 V

Bestell-No./Order-No.	Art. No.	Maße · Dimensions	g	
50890300300	50890-30	480 x 365 x 30 mm	1305	1

50898



Dreikant-Rohrsteckschlüssel

Mit Drehstift, Normdreikant für M10 und M12, DIN 3222/3223

Clé en tube triangulaire

Avec broche, triangle pour M 10 et M 12, DIN 3222/3223

Driekante paalsleutel

Met wringstaaf, norm driekant voor M10 en M12, DIN 3222/3223

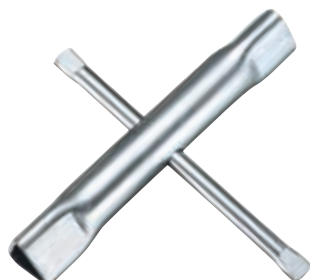

Speziell für Rettungskräfte und Hausmeister
Spécial pour services de secours et concierges
Speciaal voor hulpdiensten en huismeesters



Bestell-No./Order-No.	Art. No.	mm	g	
50898101260	50898	140 x 125	175	1

5081500

Montiereisen

Mit auswechselbarer Kunststoffschiene
Die auswechselbare Kunststoffschiene schützt Aluminium- und lackierte Felgen vor Beschädigung
Befestigungsschrauben sind nicht im Lieferumfang enthalten

Démonte-pneus

Avec gaine plastique amovible
La gaine en plastique amovible protège les jantes alu et en tôle
Les vis de fixation ne sont pas incluses

Bandenlichter

Met verwisselbare kunststof beschermkap
De verwisselbare kunststof kap beschermt aluminium en gelakte velgen tegen beschadigingen
Bevestigingsschroeven niet inbegrepen



Bestell-No./Order-No.	Art. No.	CLD mm	g	1
50815003880	5081500	380	415	1
50815005080	5081500	500	775	1

5081501

Ersatzschiene für Montiereisen

Gaine plastique de rechange pour démonte-pneus

Beschermkappen voor bandenlichters



Bestell-No./Order-No.	Art. No.	CLD mm	g	1
50815013800	5081501	380	55	1
50815015000	5081501	500	105	1

50801329

Ölfilterspinne

Spezialstahl, geschmiedete Ausführung, Oberfläche verzinkt, universell zu verwenden, für 1/2" und 3/8" Antriebe, SW 22, Ø 65-120 mm, rechts + links Lauf

Croisillon pour filtre à huile

Acier spécial, modèle forgé, surfaces galvanisées, utilisation universelle, pour entraînements 1/2" et 3/8", SW 22, Ø 65-120 mm

Oliefiltertang

Speciaalstaal, gesmede uitvoering, oppervlakte verzinkt, universeel toepasbaar, voor 1/2" en 3/8" aansluiting, SW 22, Ø 65-120 mm, rechts en links draaiend

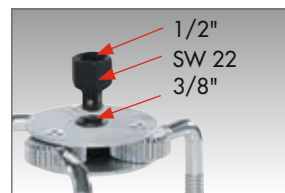

Bestell-No./Order-No.	Art. No.	g	1
50801329080	50801329	563	1

50801329-1

Ölfilter-Bandschlüssel

• Spannungsbereich Ø 65-105 mm
• Stufenlos verstellbar durch Drehknopf
• Stahlband auswechselbar
• Kompakte Bauform
Geeignet zum Lösen und Festziehen von Ölfiltern. Speziell für enge und schwer zugängliche Bereiche.

Cle pour filtre à huile

• Capacité Ø 65-105 mm
• Réglable avec bouton
• Bande en acier interchangeable
• Compact
Convient au desserrage et au serrage des filtres à huile. Spécialement conçu pour travailler dans les zones difficile d'accès.

Oliefilter bandsleutel

• Capaciteit Ø 65-105 mm
• Traploos verstelbaar door draaiknop
• Verwisselbare, stalen band
• Compact design
Voor het los- en vastdraaien van oliefilters. Speciaal voor moeilijke bereikbare en nauwe ruimtes.

new

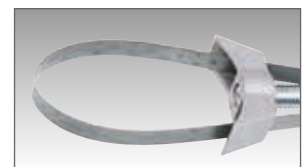
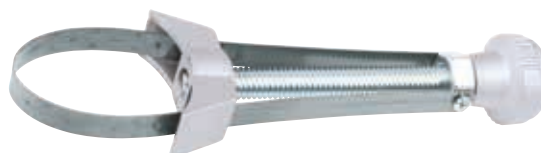

Bestell-No./Order-No.	Art. No.	CLD mm	g	1
new 50801329100	50801329-1	210	210	1



Die richtigen Helfer für Montage und Wartung

Es zählt zu unserer besonderen Leidenschaft, Ihnen ein maßgeschneidertes Werkzeugprogramm zusammenzustellen, immer ausgerichtet auf die jeweiligen Bedürfnisse. So bieten unsere Sortimente für alle Handwerksbereiche immer die passenden Werkzeuge – übersichtlich angeordnet und intelligent kombiniert. Unser Augenmerk liegt also nicht nur auf Qualität und Funktionalität, sondern zusätzlich auch auf einer optimalen, sinnvollen Ausstattung.

The right aids for automotive repairs, installation and maintenance

One of our particular passions is being able to offer you an entire portfolio of tools that are always precisely aligned with your needs. In view of this, our portfolios always offer the perfect tools for all trades and industry segments – clearly and logically categorised and intelligently combined. We set our focus not only on quality and functionality, but also on optimised and practical sets of tools.

508077-646

Sanitär Werkzeugkasten mit Modulen

6 Module, 77-tlg.

Coffret «sanitaire» avec modules

6 Modules, 77 pcs.

Sanitair gereedschapskist met modules

6 Modules, 77 delig

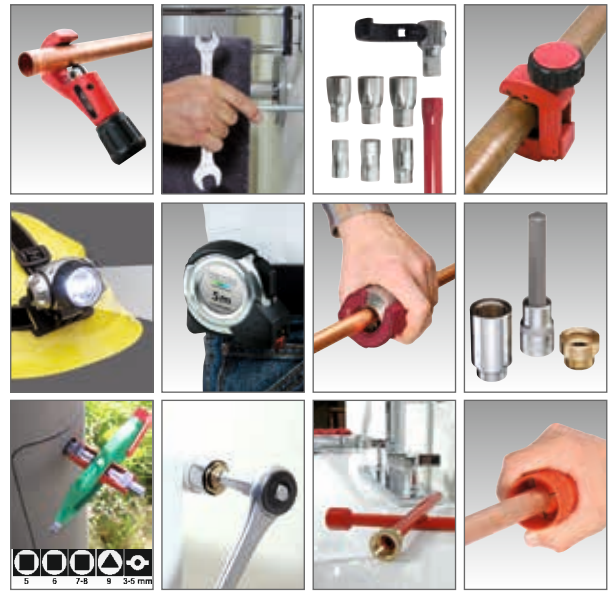

Bestell-No./Order-No.	Art. No.	Maße · Dimensions		
50807764600	508077-646	530 x 200 x 200 mm	16987	1

Inhalte der Module im Sanitärwerkzeugsatz

Modules pour coffret

Inhoud van de modules in de sanitair gereedschapskist



Modul 1

Modul 1

- Werkzeugsatz mit Meißel, Körner, Splint- und Durchtreiber
- Cuttermesser Zinkguss, Klingenbreite 18 mm, 5 Klingen
- Universalschlüssel Sanitär/Elektro
- Steckschlüssel Einsätze 6 Kt. 10/13/17/19/21/22 mm
- Stufenschlüssel 3/8" / 1/2" / 3/4" / 1"
- Verlängerung 1/2", 125 mm
- Verbindungsvierkant 1/2"
- Durchstecknarre 1/2"
- Schraubendreher- Einsätze 1/2" 12/17, 138 mm Länge

- Jeu de burins, bédanes et chasse-clous
- Cutter zingué, lame 18 mm, 5 lames
- Clé universelle électricité/sanitaire
- Douilles 6 pans 10/13/17/19/21/22 mm
- Clé etagée 3/8" / 1/2" / 3/4" / 1"
- Rallonge 1/2" 125 mm
- Carré conducteur 1/2"
- Cliquet à carré passant 1/2"
- Douilles-tournevis 1/2" 12/17, 138 mm longueur

- Set beitels, centerpunten, pendrijvers en doorslagen
- Breekmes, breedte 18 mm, 5 klingen
- Universele sleutel sanitair/elektro
- Dopsleutels 6-kant 10/13/17/19/21/22 mm
- Trapsleutel 3/8" / 1/2" / 3/4" / 1"
- Verlengstuk 1/2" 125 mm
- Venbindingsvierkant 1/2"
- Doorsteekratel 1/2"
- Schroevendraaier dopsleutels 1/2", inbus 12/17, 138 mm lang



Modul 2

Modul 2

- Greifzange 250 mm
- Eckrohrzange 1.1/2"

- Pince multiprise 250 mm
- Clé en tube coudée 1.1/2"

- Waterpomptang 250 mm
- Pijptang 1.1/2"



Modul 3

Modul 3

- Wasserwaage 230 mm
- Verstellbarer Einmaulschlüssel 305 mm
- VDE-Kombinationszange 180 mm
- VDE-Radio- und Telefonzange 200 mm
- Schlosserhammer, Fiberglasstiel, 500 g
- Stirnlampe mit 9 LED's, Gurtband
- Steinmeißel 300 x 24 mm achtkant
- Rohrentgrater innen/ausßen Ø 42 mm
- Knarrenrohrabschneider Ø 22 mm
- Halbrundfeile 200 mm
- Rundfeile 200 mm
- Sanitär-Kreuzschlüssel 200x200 mm
- Profi-Bandmaß, Zinkguss, 5 m mit Gürtelclip
- Niveau d'eau 230 mm
- Clé à molette 305 mm
- Pince universelle VDE 180 mm
- Pince téléphone VDE 200 mm
- Marteau de mécanicien, manche en fibre de verre, 500 gr.
- Lampe frontale à 9 LED's, avec bandeau élastique
- Burin à pierre octogonal 300x24 mm
- Outil à ébarber les tubes intérieur/extérieur Ø 42 mm
- Coupe-tube Ø 22 mm
- Lime demi-ronde 200 mm
- Lime-ronde 200 mm
- Clé sanitaire en croix 200x200 mm
- Mètre-ruban professionnel, zinc moulé, 5 m
- Waterpas 230 mm
- Verstelbare moersleutel 305 mm
- VDE combinatietang 180 mm
- VDE telefoontang 200 mm
- Bankhamer, glasfiber steel, 500 gr.
- Hoofdlamp met 9 LED's, hoofdband
- Steenbeitel 300 x 24 mm, achtkant
- Pijp ontbramer (binnen/buiten) Ø 42 mm
- Ratel pijpsnijder Ø 22 mm
- Vijl half rond 200 mm
- Ronde vijl 200 mm
- Sanitair kruissleutel 200x200 mm
- Professionele rolbandmaat, 5 m riemclip

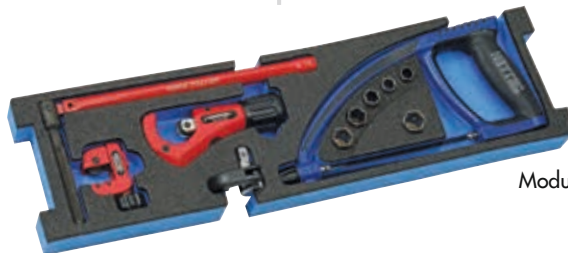

Modul 4

Modul 4

- Standhahnmutternschlüssel mit 6 Einsätzen 9/10/11/14/15/17 mm
- Mini-Rohrabschneider 3-25 mm
- Teleskop-Rohrabschneider 3-32 mm
- Mini-Metallbügelsäge 150 mm Blattlänge
- Clé lavabo avec 6 douilles 9/10/11/14/15/17 mm
- Mini coupe-tube 3-25 mm
- Coupe-tube télescopique 3-32 mm
- Mini-monture de scie à métaux avec lame de 150 mm
- Kraanmoersleutel met 6 doppen 9/10/11/14/15/17 mm
- Mini pijpsnijder 3-25 mm
- Telescopische pijpsnijder 3-32 mm
- Junior zaagbeugel 150 mm

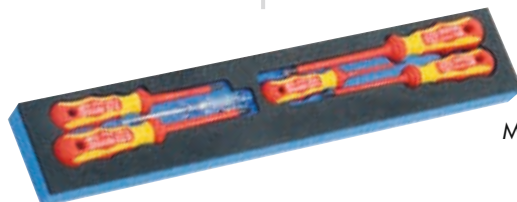

Modul 5

Modul 5

- VDE Kreuz Schlitzschraubendreher PH1/PH2 für PHILLIPS-recess Schrauben
- VDE Elektriker Schraubendreher für Schlitzschrauben 75x2,5/100x4/125x5,5 mm
- Spannungsprüfer 150-250 V
- Tournevis VDE cruciforme pour vis PHILLIPS PH1/PH2
- Tournevis d'électricien VDE pour vis à fente 75x2,5/100x4/125x5,5 mm
- Tournevis détecteurs de tension 150-250 V
- VDE Kruiskopschroevendraaier PH1/PH2
- VDE schroevendraaier voor sleufschroeven 75x2,5/100x4/125x5,5 mm
- Spanningzoeker 150-250 V

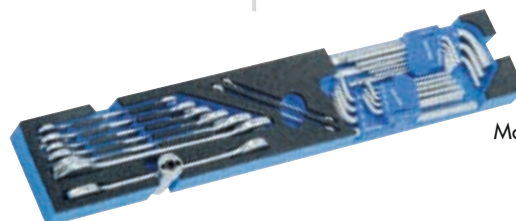

Modul 6

Modul 6

- Doppelmaulschlüssel MM 6x7/8x9/10x11/12x13/14x15/16x17/18x19/20x22
- Express-Schlüssel MM 17x19
- Kugelkopf-Winkelschraubendreher, 9-tlg. 1,5-10 mm
- TORX-Winkelschraubendreher-satz, 9-tlg. T10-T50
- Clés à fourche MM 6x7/8x9/10x11/12x13/14x15/16x17/18x19/20x22
- Clé express MM 17x19
- Jeu de clés mâles coudées à tête sphérique, 9 pces. 1,5-10 mm
- Jeu de tournevis TORX coudés 9 pces. T10-T50
- Steeksleutel MM 6x7/8x9/10x11/12x13/14x15/16x17/18x19/20x22
- Sanitairsleutel MM 17x19
- Stiftsleutelset kogelkop, 9 delig, 1,5-10 mm
- TORX stiftsleutelset, 9 delig T10-T50

508200-646

Sanitär-Werkzeug-
sortiment, 80-tlg.
in 2 Koffern

L-BOXX®-A/Modul 1+2
mit 36 Werkzeugen
L-BOXX®-B/Modul 3+4
mit 44 Werkzeugen

- Ordentlich Aufbewahren
- Einfache Klickverbindung
- Modularer Innenraum
- Einzigartiges Mobilitätssystem
- Beliebig erweiterbar
- Crashesicherer Transport
- Aus schlag- und stoßfestem ABS-Kunststoff
- Ergonomisch geformten Griffe, zusätzliche seitliche Griffschalen sowie praktische Schlaufen garantieren ein flexibles und komfortables Handling
- Der Deckel ist bis 100 kg belastbar, spritzwassergeschützt
- Beladungskapazität pro Box bis zu 25 kg
- Transport der Boxen im Verbund bis 40 kg

Assortiment d'outils
sanitaire, 80 pces. en 2
coffrets

L-BOXX®-A/Module 1+2
avec 36 outils
L-BOXX®-B/Module 3+4
avec 44 outils



- Ranger proprement
- Connexion facile par simple clic
- Intérieur modulaire
- Système de mobilité unique
- Extensible si nécessaire
- Transport anti-crash
- Fabriqué en plastique ABS résistant aux chocs et aux impacts
- Poignées de formes ergonomique. Poignées latérales supplémentaires ainsi que des boucles pratiques qui garantissent une flexibilité et manipulation confortable
- Le couvercle peut tenir 100 kg et est résistant aux éclaboussures
- Capacité de chargement par boîte jusqu'à 25 kg
- Transport des boîtes en combinaison jusqu'à 40 kg

Sanitair gereedschapset,
80-dlg in 2 kisten

L-BOXX®-A/Module 1+2
met 36 stuks gereedschap
L-BOXX®-B/Module 3+4
met 44 stuks gereedschap

- Overzichtelijk bewaren
- Eenvoudig klik-mechanisme
- Modulaire indeling
- Uniek mobiliteitssysteem
- Naar wens uitbreidbaar
- Crashbestendig transport
- Van slag-en stootvast ABS
- Ergonomisch gevormde grepen, met extra zijgrepen en praktische lussen voor flexibele en comfortabele handling
- Deksel tot 100 kg belastbaar, spatwaterdicht
- Koffer belastbaar tot 25 kg
- Bij gekoppelde koffers belastbaar tot 40 kg



Bestell-No./Order-No.	Art. No.	Maße · Dimensions	Module · Modules		
new 50820064600	508200-646	442 x 357 x 151 mm	50807740100 50807740200 50807740300 50807740400	16780	1

508200-771

Sanitär-Werkzeug-sortiment, 36-tlg.

L-BOXX®/Modul 1+2
mit 36 Werkzeugen

Assortiment d'outils
sanitaire, 36 pces.

L-BOXX®/Module 1+2
avec 36 outils

Sanitair gereedschapset,
36-dlg.

L-BOXX®/Module 1+2
met 36 stuks gereedschap



Bestell-No./Order-No.	Art. No.	Maße · Dimensions	Module · Modules	g	
new 50820077100	508200-771	442 x 357 x 151 mm	50807740100 50807740200	8030	1

508200-772

Sanitär-Werkzeug-sortiment, 44-tlg.

L-BOXX®/Modul 3+4
mit 44 Werkzeugen

Assortiment d'outils
sanitaire, 44 pces.

L-BOXX®-B/Module 3+4
avec 44 outils

Sanitair gereedschapset,
44-dlg.

L-BOXX®/Module 3+4
met 44 stuks gereedschap



Bestell-No./Order-No.	Art. No.	Maße · Dimensions	Module · Modules	g	
new 50820077200	508200-772	442 x 357 x 151 mm	50807740300 50807740400	8770	1

508077-401

Sanitär-Werkzeug-
sortiment für L-BOXX®,
26-tlg.













Assortiment d'outils
sanitaire pour L-BOXX®,
26 pces.

Sanitair gereedschapset
voor L-BOXX®, 26-dlg.

new



enthaltend/containing/composition

-  260 mm
-  MM 17 x 19
-  125 mm
-  MM 12/17
-  MM 10/13/17/19/21/22
-  3/8", 1/2", 3/4", 1"
-  75 mm
-  Ø 3 - 25 mm
-  Ø 3 - 25 mm
-  Ø 42 mm
-  MM 10/12/17/22
-  Ø 10 - 32 mm
-  1/4"

Bestell-No./Order-No.

Art. No.

Maße · Dimensions



new

50807740100

508077-401

405 x 310 x 60 mm

4140

1

508077-402

Sanitär-Werkzeug-
sortiment für L-BOXX®,
10-tlg.

Assortiment d'outils
sanitaire pour L-BOXX®,
10 pces.

Sanitair gereedschapset
voor L-BOXX®, 10-dlg.

new



enthaltend/containing/composition

-  180 mm
-  200 mm
-  PZ 1 / 2
-  MM 0,5 x 2,5 x 75 / 0,8 x 4,0 x 100 / 1,0 x 5,5 x 125
-  150 - 250 V
-  200 mm
-   LED

Bestell-No./Order-No.

Art. No.

Maße · Dimensions



new

50807740200

508077-402

405 x 310 x 40 mm

1610

1

508077-403

Sanitär-Werkzeug-
sortiment für L-BOXX®,
9-tlg.

Assortiment d'outils
sanitaire pour L-BOXX®,
9 pces.

Sanitair gereedschapset
voor L-BOXX®, 9-dlg.

new



enthaltend/containing/composition

- 3 m
- Gr. 18 mm
- 320 mm
- 150 mm
- 500 g
- 24 x 300 mm, 8-kt.
- 200 mm



Bestell-No./Order-No.	Art. No.	Maße · Dimensions		
new 50807740300	508077-403	405 x 310 x 40 mm	2830	1

508077-404

Sanitär-Werkzeug-
sortiment für L-BOXX®,
35-tlg.

Assortiment d'outils
sanitaire pour L-BOXX®,
35 pces.

Sanitair gereedschapset
voor L-BOXX®, 35-dlg.

new



enthaltend/containing/composition

- Ø 3 x 120 mm
- Ø 5 x 150 mm
- Ø 3 x 120 mm
- 5 x 130 mm
- 12 x 130 mm / 14 x 150 mm
- MM 6 x 7 / 8 x 9 / 10 x 11 / 12 x 13 / 14 x 15 / 16 x 17 / 18 x 19 / 20 x 22
- MM 0 - 30
- 250 mm
- MM 1,5/2/2,5/3/4/5/6/8/10
- TX 10/15/20/25/27/30/40/45/50
- 230 mm



Bestell-No./Order-No.	Art. No.	Maße · Dimensions		
new 50807740400	508077-404	405 x 310 x 55 mm	3320	1

5081791-0

Profi-Kartuschenpistole Compact

- Kompakte Bauform durch innovative innenliegende Betätigungsmechanik
- Gleichbleibend kompakte Abmessung, unabhängig vom verbrauchten Inhalt
- Mit Verbrauchsanzeige
- Nachlaufstop bei Nichtbetätigung

Pistolet professionnel compact pour cartouches

- Design compact avec mécanisme de fonctionnement intérieur innovante
- Dimension compacte constante, quelle que soit le matériel consommé
- Avec jauge de carburant
- Frein spécial en cas de non activité

Professioneel kitpistool 'Compact'



- Compacte model, dankzij innovatief, inwendig mechanisme
- Gelijkblijvende, compacte afmeting, onafhankelijk van het verbruikte materiaal
- Met verbruiksaanwijzing
- Met automatische stop



Nur geeignet für leicht pressbare Medien, wie Silikone und Acryle. Nicht geeignet für zähe Medien, wie Kleber! Alternative: Kartuschenpistole Multipower verwenden.

Only suitable for easily compressible media like silicone and acrylic. Unsuitable for viscous media like glue. Alternative: Caulking Gun Multipower.



Bestell-No./Order-No.	Art. No.	Maße · Dimensions		
50817910000	5081791-0	340 x 205 x 65 mm	720	1

5081791-1

Profi-Kartuschenpistole Multipower

- Stabile, aufwendige Konstruktion für extreme Beanspruchung
- Betätigung aus hochwertigem Aluminium-Druckguss
- Ermüdungsfreies Verarbeiten von sämtlichen Medien durch kraftvolle Hebelübersetzung



Pistolet pour cartouches multipower

- Construction stable pour utilisation dans des conditions extrêmes
- Fonctionnement en fonte d'aluminium de haute qualité
- Utilisation simple sans effort grace au levier puissant

Professioneel kitpistool 'Multipower'

- Stabiele, solide constructie voor extreme belastingen
- Hefboommechanisme uit hoogwaardig druggiet aluminium
- Moeiteloos verwerken van alle kitsoorten dankzij de sterke overbrenging



Bestell-No./Order-No.	Art. No.	Maße · Dimensions		
50817910100	5081791-1	360 x 225 x 65 mm	800	1

5081791-2

Profi-Kartuschenpistole MultiPower Universal

- Vollummantelte Kartuschenpistole mit Aluminium Gehäuse aus Strangpressprofil
- Betätigung aus hochwertigem Aluminium-Druckguss
- Universalverarbeitung von Kartuschen und Beuteln
- Stabile, aufwendige Konstruktion für extreme Beanspruchung
- Glasfaserverstärkte Schraubkappen
- Ermüdungsfreies Verarbeiten von sämtlichen Medien durch kraftvolle Hebelübersetzung
- Für alle gängigen Kartuschen und Beutel mit einem Volumen von 310/600 ml geeignet
- Inklusive zwei Dosierspitzen

Pistolet pour silicone professionnel multipower universal

- Pistolet pour silicone entièrement gainé avec boîtier en aluminium profilés extrudés
- Fonctionnement en fonte d'aluminium de haute qualité
- Traitement universelle des cartouches et sacs
- Construction stable pour utilisation dans des conditions extrêmes
- Utilisation simple sans effort grace au levier puissant
- Convient pour toutes les cartouches et sacs standard avec un volume de 310/600 ml
- Y compris deux seringues

Professioneel kitpistool MultiPower Universeel

- Gesloten kitpistool met hoogwaardige, aluminium behuizing
- Hefboommechanisme uit hoogwaardig drukgiet aluminium
- Voor verwerking van kokers en worsten
- Stabiele, solide constructie voor extreme belastingen
- Moeiteloos verwerken van alle kitsoorten dankzij de sterke overbrenging
- Voor alle gangbare kokers van 310/600 ml
- Inclusief 2 spuitmondjes en een drukplaat



Bestell-No./Order-No.	Art. No.	Maße · Dimensions	g	
50817910200	5081791-2	360 x 255 x 65 mm	1050	1
50817910300	5081791-3	490 x 255 x 65 mm	1400	1
*50817912200	5081791-22		62	2
**50817912300	5081791-23		300	2

* Dosierspitzenset/Tube nozzles 10-tlg./pcs. für Profi-Kartuschenpistole/for professional caulking gun multipower universal 50817910200/XL: 50817910300

** Ersatz Verschlusskappe/Black Cap 2-tlg./pcs. für Profi-Kartuschenpistole/for professional caulking gun multipower universal 50817910200/XL: 50817910300

5081791-90

Fugenabzieher im Set

Fugenabzieher Set zum Abziehen, Glätten und Formen von dauerelastischen Fugenmassen (17 verschiedene Möglichkeiten)



Set avec 4 palettes à lisser

Set avec palettes à lisser pour le retrait, le lissage et le façonnage de joints à élasticité permanente (17 façons différentes)

Multifunctionele kitlepel

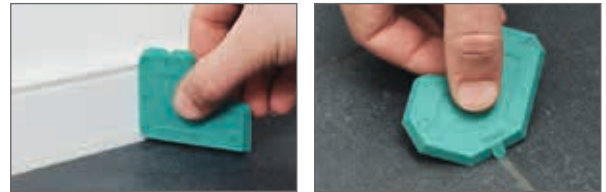
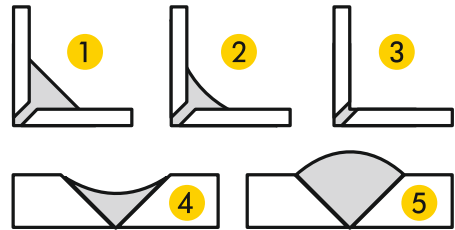
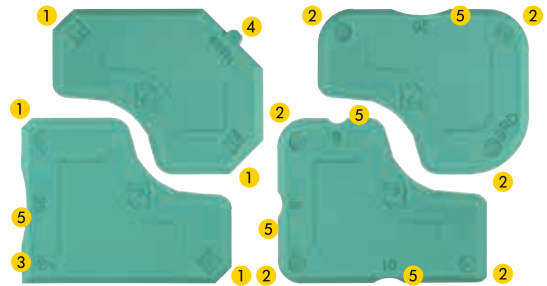
Kitlepel voor het gladstrijken en vormen van elastische kitten (17 verschillende mogelijkheden)



Bestell-No./Order-No.	Art. No.	Maße · Dimensions		
50817919000	5081791-90	225 x 160 x 10 mm	88	1

5081790-1

Handhebelfettpresse

DIN 1283, L = lackiert, Kopf aus Zinkdruckguß, robuster Stahlrohrkörper zur Füllung mit Kartuschen, losem Fett und durch Füllgeräte, mit 330 mm langem Gummipanzerschlauch und 170 mm langem abgewinkeltes Druckrohr. Ideal zum Schmieren von mechanischen Werkzeugen und Maschinen, universell passend für alle gängigen Schmiernippel.
• Ergonomischer Handgriff

Pompe a graisse a levier



DIN 1283, L = laquées
Tête en zinc injecté, corps robuste en tôle à remplir de cartouches de graisse. Equipé d'un bec flexible en caoutchouc de 330 mm de long et tube de pression coudée de 170 mm de long. Idéal pour la lubrification mécanique des outils et machines.
Universellement adapté à tous mamelons de graisse communs.
• Poignée ergonomique

Schaarvetspuit

DIN 1283, L= gelakt, kop uit druk-gietzink, robuuste behuizing voor het vullen met vetpatronen, los vet d.m.v. hand en los vet d.m.v. vulapparaat. Met 330 mm lange, sterke rubber slang en 170 mm lange, gebogen drukpijp. Ideaal voor het smeren van mechanische gereedschappen en machines, universeel passend op alle gangbare smeernippels.
• Ergonomische handgreep

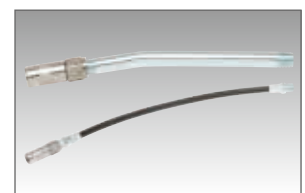
new



Bestell-No./Order-No.	lose/bulk	Inhalt/capacity ccm Kartuschen/cartridges	 mm "		
new 50817900120	500	400	380/690	1100	1

5021450-1

Saugheber

Aus hochwertigem Aludruckguss

2 bewegliche Saugköpfe, Ansaugmechanik und Sicherheitsverriegelung. Ideal zum Transportieren, Ein- und Ausheben von PKW-Glas, Duschwannen, Fensterscheiben, Türen, Blechen, etc.
Traglast gesamt: 80 kg

Ventouses

D'aluminium de haute qualité

2 ventouses, système mécanique d'aspiration et blocage de sécurité idéal pour transporter, monter et démonter des pare-brises, portes, tôtes etc.
Capacity: 80 kg

Zuigheffer

Uit hoogwaardig spuitgiet aluminium

2 beweegbare zuigkoppen, aanzuigmechanisme en veiligheidsvergrendeling. Ideaal voor transporteren, plaatsen en verwijderen van autoruiten, douchewanden, vensterglas, deuren, etc.
Draagkracht totaal: 80 kg

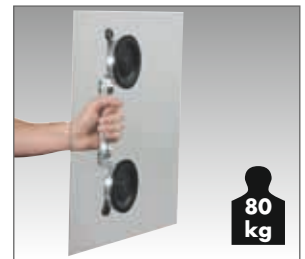

Bestell-No./Order-No.	Art. No.	Maße · Dimensions			
50214500100	5021450-1	225 x 160 x 10 mm	80 kg	2200	1

5021450-2

Saugheber

Aus hochwertigem Aludruckguss

3 bewegliche Saugköpfe, Ansaugmechanik und Sicherheitsverriegelung. Ideal zum Transportieren, Ein- und Ausheben von PKW-Glas, Duschwannen, Fensterscheiben, Türen, Blechen, etc.
Traglast gesamt: 120 kg

Ventouses

D'aluminium de haute qualité

3 ventouses, système mécanique d'aspiration et blocage de sécurité idéal pour transporter, monter et démonter des pare-brises, portes, tôtes etc.
Capacity: 120 kg

Zuigheffer

Uit hoogwaardig spuitgiet aluminium

3 beweegbare zuigkoppen, aanzuigmechanisme en veiligheidsvergrendeling. Ideaal voor transporteren, plaatsen en verwijderen van autoruiten, douchewanden, vensterglas, deuren, etc.
Draagkracht totaal: 120 kg

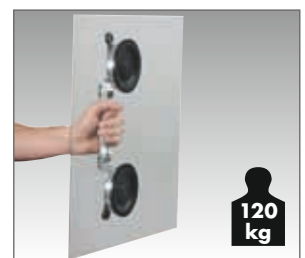

Bestell-No./Order-No.	Art. No.	Maße · Dimensions			
50214500200	5021450-2	370 x 325 x 90 mm	120 kg	4500	1

5081640-25

Mini-Rohrabschneider

Qualitäts-Rohrabschneider für enge Arbeitsbereiche, Schneidkapazität von Rohren Ø 3-25 mm, sichere Kraftübertragung durch Doppelführung, spezielle Bauform mit kleinem Arbeitsradius

Mini coupe-tube

Coupe-tubes de qualité pour des travaux difficiles d'accès, capacité de coupe de tubes de 3 à 25 mm, transmission de force assurée par un double guidage, construction spéciale avec petit rayon de travail

Mini pijpsnijder

Kwaliteits pijpsnijder voor kleine werkruimtes, snijcapaciteit van buizen Ø 3-25 mm, goede krachtoverbrenging dankzij dubbele geleiding, speciale constructie met kleine werkruimte



Bestell-No./Order-No.	Art. No.	Ø mm	1	g	
50816402500	5081640-25	80	3-25	160	1
50816430100	5081643-1	Stahl	16	5	1
50816430200	5081643-2	Kupfer	16	5	1

*Ersatz-Schneiderad · Replacement cutting wheel · Roulette de coupe de rechange

* Stahl/Kupfer · Steel/Copper · Acier/Cuivre

5081640-32

Teleskop-Rohrabschneider

Qualitäts-Rohrabschneider für dünnwandige Rohre Ø 3-32 mm, max. Wanddicke bis 4 mm, sichere Kraftübertragung durch Teleskopführung, Schneiderad aus Spezialstahl für extrem lange Haltbarkeit, leichtes Verstellen des Arbeitsbereiches

Coupe-tube télescopique

Coupe-tubes de qualité pour tubes à paroi mince, diamètre de 3 à 32 mm, paroi ép. maxi jusqu'à 4 mm, transmission de force assurée par un guidage télescopique, construction spéciale avec petit rayon de travail

Telescopische pijpsnijder

Kwaliteits pijpsnijder voor dunwandige pijp Ø 3-32 mm, max. wanddikte tot 4 mm, goede krachtoverbrenging door telescoopgeleiding, snijwieltje uit speciaalstaal voor extreem lange levensduur, eenvoudig verstellen van het bereik



Bestell-No./Order-No.	Art. No.	Ø mm	1	g	
50816403200	5081640-32	135	3-32	400	1
50816430100	5081643-1	Stahl	16	5	1
50816430200	5081643-2	Kupfer	16	5	1

* Stahl/Kupfer · Steel/Copper · Acier/Cuivre

5081643-15
5081643-22

Knarrenrohrabschneider

Qualitäts-Knarren-Rohrabschneider, ideal für schwer zugängliche Stellen, kein Nachstellen erforderlich, da Eigenklemmung und Selbstnachstellung, schnelles Trennen von Rohren mit wenigen Umdrehungen

Coupe-tubes à cliquet

Coupe-tubes à cliquet de qualité, idéal pour les endroits difficiles d'accès, pas de réglage nécessaire, ajustage et serrage automatiques

Ratel pijpsnijder

Kwaliteits ratel pijpsnijder, ideaal voor moeilijk bereikbare plaatsen, geen nastellen nodig, klemt en stelt automatisch bij, sneller snijden van pijpen met minder omwentelingen



Bestell-No./Order-No.	Art. No.	Ø mm	Ø	g	Box
50816431500	5081643-15	65	15	245	1
50816432200	5081643-22	75	22	276	1
50816430300	5081643-3	Kupfer	16	5	1

*Ersatz-Schneiderad · Replacement cuttingwheel · Roulette de coupe de rechange

* Kupfer · Copper · Cuivre

5081646-42

Kunststoff-Rohrabschneider

Zum Schneiden von PVC Kabelkanälen, Plastikrohren, Gummischläuchen, etc. Schneidekapazität bis Ø 42 mm mit Ratschenfunktion. Robuster Aluminiumkörper.

Coupe tube PVC

Pour couper des canalisations de câbles en PVC, tuyaux en caoutchouc. Capacité de coupe jusque 42 mm diamètre à cliquet. Corps en aluminium solide.

PVC schaar

Voor het knippen van PVC kabelgoten, kunststof buizen, rubber slangen, etc. Snijscapaciteit tot Ø 42 mm. Met ratelfunctie. Robuuste aluminium uitvoering.



Bestell-No./Order-No.	Art. No.	Ø mm	Ø	g	Box
50816464200	5081646-42	210	42	370	1

5081640-42

Rohrentgrater Außen/Innen

Massives Zinkdruckgußwerkzeug, Entgratung von Rohren bis Ø 42 mm, gehärtete Spezialklingen, einfache Handhabung

Ebarbeuse de tubes extérieur/intérieur

Erbabeuse de tubes de qualité en zinc moulé sous pression, Erbage de tubes jusqu'à 42 mm, affûtoir spécial trempé,

Pijpontbramer buiten/binnen

massief zinksplietgereedschap, ontbramen van pijpen tot Ø 42 mm, geharde speciale messen, eenvoudige bediening



außen, outside, extérieur

innen, inside, intérieur

Bestell-No./Order-No.	Art. No.	Ø	g	Box
50816404200	5081640-42	42	245	1

5081756-1

2 in 1 Kupferrohrbürste

Für Innen- und Außenreinigung von Kupferrohren.
Ø 15 mm / Ø 22 mm

2 en 1 brosse tube cuivre

Pour nettoyage intérieur et extérieur des tuyaux en cuivre.
Ø 15 mm / Ø 22 mm

2 en 1 pijpborstel

Voor in- en uitwendig reinigen van koperen pijp.
Ø 15 mm / Ø 22 mm



Ø 15/22 mm



Ø 15/22 mm

Bestell-No./Order-No.	Art. No.	CLØ mm	Ø	g	1
50817560100	5081756-1	200	15 / 22 mm	100	1

5081648

Drahtsäge Set, 4-tlg.

Bestehend aus 2 spiralverzahnten Sägedrähten, sowie 2 Zugringen. Zum Schneiden von ABS, PVC und CPVC Rohren in Ecken und an schwer zugänglichen Stellen. In Abhängigkeit des zu schneidenden Materials, mehrmaliger Einsatz möglich.

Scie fil, 4 pcs.

Comprenant de 2 fils de coupe en spirale à dents et 2 anneaux de traction. Pour la coupe d'ABS, le PVC et les tubes PVC-C dans des coins et dans les endroits difficiles d'accès. Selon le matériel à couper emploi répétée est possible.

Draadzaagset, 4 delig

Bestaand uit 2 spiraalvertande zaagdraden en twee grepen. Voor het zagen van ABS, PVC en CPVC buizen in hoeken en moeilijk bereikbare plaatsen. Afhankelijk van het te zagen materiaal meermaals te gebruiken

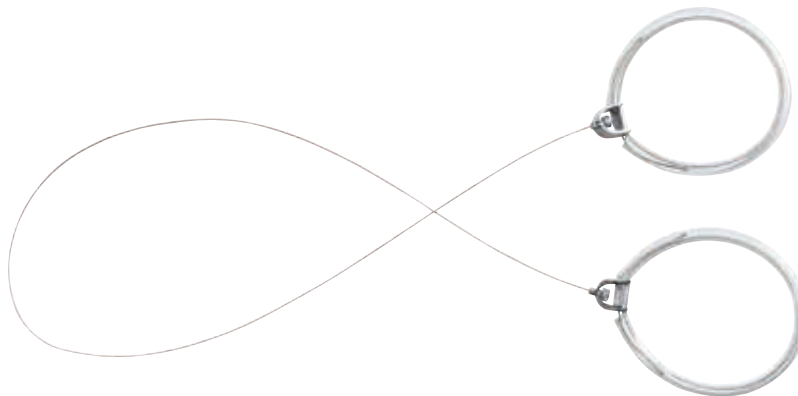

Bestell-No./Order-No.	Art. No.	CLØ mm	g	1
50816480000	5081648	800	30	1
*50816480200	5081648-2	600	20	1

* Ersatz-Sägedraht, 2-tlg. · Spare cutting wire, 2 pcs. · Fil de scie de rechange, 2 pcs.

50958

Express-Schlüssel

Chrom-Vanadium, verchromt, Montageschlüssel für Express- und Stockschrauben, Mittelstück mit Innengewinde für Stockschrauben M 10, für Waschtischbefestigungen und Eckventilmontagen

Cle express

Chrome-Vanadium, chromés, pour le montage et le demontage de vis d'arrêt de fixation de lavabo, pattea vis, montage d'equerre. Partie mediane avec filetage et bille integre pour vis M 10

Sanitair sleutel

Chroom-Vanadium, verchromd, montage sleutel voor sanitair schroeven M 10, wastafelbevestiging en knieknelkoppelingen



Bestell-No./Order-No.	Art. No.	MM	CLØ mm	g	5
50958171980	50958	17 x 19	223	265	5

50750-01

1/2"

Durchstecknarre mit Verbindungsvierkant, 2-tlg.

DIN 3122 C
Chrom-Vanadium, verchromt

Cliquet avec carré conducteur, 2 pces.

DIN 3122 C
Chrome-Vanadium, chromées

Doorsteekratel met verbindingsvierkant, 2 delig

DIN 3122 C
Chroom Vanadium, verchromd



Bestell-No./Order-No.	Art. No.		\varnothing mm	g	
50750010080	50750-01	1/2"	260	490	5

50750-01-1

1/2"

Durchstecknarre, ohne Verbindungsvierkant

DIN 3122 C
Chrom-Vanadium, verchromt

Cliquet, sans carré conducteur

DIN 3122 C
Chrome-Vanadium, chromées

Doorsteekratel, zonder verbindingsvierkant

DIN 3122 C
Chroom-Vanadium, verchromd



Bestell-No./Order-No.	Art. No.	\varnothing mm	g	
50750010180	50750-01-1	260	430	5

90050-16

1/2"

Verbindungsvierkant

Chrom-Vanadium, verchromt, für 1/2" Verbindungen

Carre conducteur

Chrome-Vanadium, chromées, pour 1/2" connexions

Verbindungsvierkant

Chroom-Vanadium, verchromd, voor 1/2" hulpstukken



Bestell-No./Order-No.	Art. No.	\varnothing mm	g	
90050160083	90050-16	37	45	10

90050-4

1/2"

Stufenschlüssel

Chrom-Vanadium, verchromt für Ein- und Ausbau von Heizkörperventilnippeln, Rücklaufverschraubungen und kurzen Hahnverlängerungen

Cle etagee

Chrome-Vanadium, chromés Pour le montage et le demontage de raccords de soupapes

Trapsleutel

Chroom-Vanadium, verchromd, voor in- en uitdraaien van radiatorkoppelingen, terugslagkleppen, en korte kraanverlengstukken

3/8" / 1/2" / 3/4" / 1"



Bestell-No./Order-No.	Art. No.	\varnothing mm	g	
90050400080	90050-4	90	120	1

58103

Stufenschlüssel-Satz
In Kunststoffschraubverpackung

Jeu cliquet et clé étagée
En étui plastique cylindrique

Trapsleutelset
In kunststof schroefkoker



Bestell-No./Order-No.	Art. No.	Ø mm	g	
58103000100	58103	290	610	1

98263-06

Spezial-Kardangelen
Chrom-Vanadium, verchromt, beide Antriebsseiten mit Innenvierkant

Cardan universel spécial
Chrome-Vanadium, chromés, les deux côtés d'entraînement avec carré intérieur

Speciaal cardangewricht
Chroom-Vanadium, verchromd, beide zijden met binnenvierkant 1/2"



Bestell-No./Order-No.	Art. No.	Ø mm	g	
98263060080	98263-06	65	180	1

50780

Sanitär-Garnitur 11-tlg.
Chrom-Vanadium, verchromt, in Metallkasten

Jeu d'outils « sanitaire » 11 pces.
Chrome-Vanadium, chromées, en coffret métallique

Sanitair gereedschapset 11 delig
Chroom-Vanadium, verchromd, in metalen kist



enthaltend/containing/composition	
	MM 10/13/17/19/21
	260 mm
	MM 17 x 19
	125 mm
	90 mm
	MM 6
	34 mm



Bestell-No./Order-No.	Art. No.	Maße · Dimensions	g	
50780809580	50780	318 x 119 x 49 mm	2480	1

508494-016

Ölbrennerschlüssel

Clés à huile

Oliebrander sleutel



new



Bestell-No./Order-No.	Art. No.	MM	mm	g	
new 50849401680	508494-016	16	250	250	1

90950

Standhahnmutternschlüssel

Cle lavabo

Kraanmoersleutel

Chrom-Vanadium, lackiert, gesenkgeschmiedet, sehr robust, schwenkbarer Quergriff, mit schwenkbarer, gefederter Klaue für Rechts- und Linksgang. Für sämtliche Verschraubungen und Standhähne geeignet.

Chrome-Vanadium, laqués, avec manche et machoire articulée pour un maniement aisé. Fonctionnement droite/gauche

Chroom-Vanadium, gelakt, met zwekbare greep voor links- en rechtshandig gebruik.

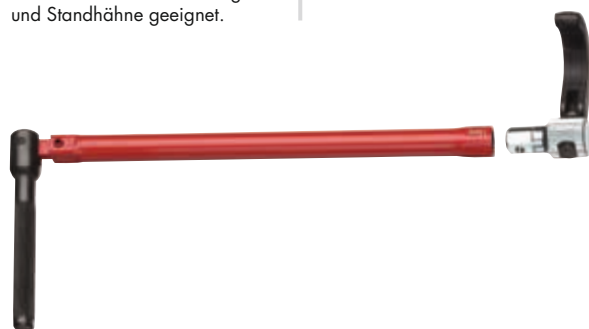

Bestell-No./Order-No.	Art. No.	mm	∅	AF	mm	g	
90950103220	90950	10 - 32		3/8" - 1.1/4"	240	520	2

90955

Sanitärkreuzschlüssel

Cle sanitaire en croix

Sanitair kruissleutel

Lackiert, Spezialschlüssel für die Sanitärtechnik, zum Ein- und Ausbau von Hahnverlängerungen, Heizkörperventile, sowie Rücklaufverschraubungen 3/8" / 1/2" / 3/4" / 1" und Express Schrauben M 8 / M 10 / M 12

Laqués, pour le montage et le démontage: de robinets 3/8" / 1/2" / 3/4" / 1" de vis d'arrêt de fixation de lavabo M 8 / M 10 / M 12

Gelakt, speciale sleutel voor de installatietechniek, voor in- en uitdraaien van kraanverlengstukken 3/8" / 1/2" / 3/4" / 1" en montagesbouten M 8 / M 10 / M 12



Bestell-No./Order-No.	Art. No.	MM	mm	g	
90955020020	90955	10 / 12 / 17 / 22	200 x 200	520	5



Optimaler Schutz im Arbeitsleben

Keine Arbeit ist ohne Risiko. Gefahren werden aber leider in vielen Arbeitsbereichen unterschätzt oder überhaupt nicht erkannt. Umso wichtiger ist es, die erforderlichen Maßnahmen zu treffen, um Sicherheit und Gesundheit zu gewährleisten und einen optimalen Schutz zu bieten. Deshalb hat es bei uns oberste Priorität, der jeweiligen Aufgabe entsprechend die am besten geeignete Schutzausrüstung bereitzustellen.

Optimum protection at work

No job is completely free of risks. Unfortunately, in many areas, these risks are underestimated or not even recognised as such. It is, therefore, all the more important to take appropriate measures to ensure health and safety and offer optimum protection in the workplace. This is why, for us, the utmost priority is to deliver the most suitable protective equipment for the job at hand.



5081731

Schutzbrille

DIN EN 166 F

Lunette de protection

DIN EN 166 F

Veiligheidsbril

DIN EN 166 F



Bestell-No./Order-No.	Art. No.		
50817310000	5081731	70	1

5081732

Kapsel-Gehörschutz

CE/EN 352-1

- Hoher Dämmwert SNR 30 dB
- Kunstleder Kopfband
- Kunstleder gepolsterte Ohrmuschel
- Einfaches Anpassen an jede Kopfform durch vielfältige Verstellmöglichkeiten
- Kompakt zusammenfaltbar für einfachen Transport
- CE-geprüft nach EN 352-1 2003

Protecteur auditif

CE/EN 352-1

- Valeur d'isolation élevée SNR 30 dB
- Bandeau en plastique
- Similicuir oreille rembourrés
- Facile à adapter à n'importe quelle forme de tête grâce à un ajustement multiple
- Se plie de manière compacte pour un transport facile
- Testés CE selon la norme EN 352-1 2003

Gehoorbescermer

CE/EN 352-1

- Hoge demping SNR 30 dB
- Kunststof hoofdband
- Met kunstleer gepolsterde oorkappen
- Eenvoudig in grootte aanpasbaar dankzij de vele verstelmogelijkheden
- Compact opvouwbaar voor eenvoudig transport
- CE getest volgens EN 352-1 2003

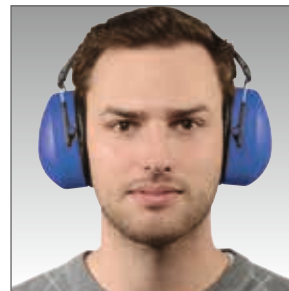

Bestell-No./Order-No.	Art. No.		
50817320000	5081732	240	1

5081733

Arbeitshandschuhe

CE/EN 388-4131

- Aus atmungsaktivem, strapazierfähigem Nylonmaterial
- Handinnenflächen Nitril Schaum beschichtet
- Ausgezeichnete Passform
- Sehr gutes Tastempfinden
- Hohe Griffsicherheit bei Feuchtigkeit
- Hervorragende Beständigkeit gegen Öle und Fette

Gants de travail

CE/EN 388-4131

- Fabriqué nylon durable et respirant
- Paume enduite de nitrile
- Ajustement excellent
- Très bon contact
- Prise exceptionnelle lorsqu'il est humide
- Excellente résistance contre des matières grasses

Werkhandschoenen

CE/EN 388-4131

- Van ademend, duurzaam nylon
- Voorzien van Nitril coating
- Uitstekende pasvorm
- Goede vingergevoeligheid
- Goede grip bij vocht
- Uitstekend bestand tegen oliën en vetten



Bestell-No./Order-No.	Art. No.	Größe · Size		
50817330800	50817-33-08	8"	30	12
50817330900	50817-33-09	9"	30	12

5081611-1

Japansäge

- Inkl. 2 Sägeblätter (fein/mittel)
- Austausch des Sägeblattes durch Knopfdruck
- Extra dünnes Sägeblatt - besonders geeignet für schwer zugängliche Stellen
- Hochwertige SK5-Stahl Sägeblätter, Zähne induktiv gehärtet

Scie japonaise

- Incl. 2 lames de scie (fines/moyennes)
- Remplacer la lame en appuyant un bouton
- Lame extra fine - particulièrement approprié pour zones d'accès difficile
- Lames en acier SK5 - dents trempées par induction

Japanse zaag

- Met 2 zaagbladen (fijn/middel)
- Zaagblad verwisselbaar door drukknop
- Extra dun zaagblad - uitermate geschikt voor moeilijk bereikbare plaatsen
- Hoogwaardig SK5-stal zaagblad, tanden inductief gehard



Sauberer, glatter Schnitt durch feine Zahnung
Clean and smooth cut appearance by fine toothing



Schnittbild mit herkömmlicher Säge
Cut appearance of a conventional saw





22er Zahnung (fein)
22 teeth per inch (fine)



17er Zahnung (mittel)
17 teeth per inch (medium)



Bestell-No./Order-No.	Art. No.	 mm	 g	
50816110100	5081611-1	320	180	1

5081613

Multifunktion Handsäge, 3-tlg.

- Besonders geeignet für schwer zugängliche Stellen
- Griff in zwei Winkel einstellbar, einfache Handhabung
- Hochwertiger 2-K Kunststoff-handgriff
- Der Griff nimmt sowohl Säbel-sägeblätter mit 1/2" Standardaufnahme als auch 1/4" Standardbits auf, sicherer Halt und einfacher Austausch
- Je ein Sägeblatt für Metall 6"X24T / Holz 6"X10T, Zähne induktiv gehärtet
- Zwei Winkeleinstellung möglich, der Griff rastet automatisch in die Arbeitsposition ein

Scie a main multifonction, 3 pcs.

- Particulièrement adapté pour lieux difficile d'accès
- Poignée réglable en deux angles, manipulation facile
- Manche en plastique, 2 composants, haute qualité
- La poignée accepte 1/2" lames de scie alternative et embouts hexagonaux standard 1/4" remplacement facile des lames de scie
- Lame de scie pour le métal 6"X24DTS/ pour le bois 6"X10DTS, denture trempée
- Deux réglages d'angle possibles, la poignée se verrouille automatiquement la position de travail

Multifunctionele handzaag, 3-dlg.

- Ideaal voor moeilijk bereikbare plaatsen
- Greep in 2 standen verstelbaar, eenvoudig te gebruiken
- Hoogwaardige 2-comp. kunststof greep
- Greep is geschikt voor 1/2" reciprozagen en 1/4" bits, stevige vergrendeling en eenvoudig verwisselbaar
- 1 zaagblad voor metaal 6"/24t en 1 voor hout 6"/10t, tanden inductief gehard
- Twee instelbare hoeken mogelijk, de greep blokkeert automatisch in positie



Bestell-No./Order-No.	Art. No.	Ø mm	g	mm
new 50816130000	5081613	280	250	5

5081613-10

Sägeblätter-Set für Holz, 5-tlg.

- Geeignet für HEYTEC Multifunktion Handsäge Art. No. 5081613
- Hochwertige Sägeblätter, Zähne induktiv gehärtet
- Sägeblatt für Holz 6"X10T
- Sicherer Halt und einfacher Austausch des Sägeblattes

Assortiment 5 lames de scies pour bois

- Convient pour HEYTEC scie à main multifonction Art. 5081613
- Lames d'acier de qualité supérieure, denture trempée par induction
- Lame de scie pour bois 6"X10T
- Remplacement facile de la lame de scie

Set zaagbladen voor hout, 5 stuks

- Geschikt voor HEYTEC multifunctionele handzaag, art.nr. 5081613
- Hoogwaardige zaagbladen, tanden inductief gehard
- Zaagblad voor hout 6"X10T
- Stevige vergrendeling en eenvoudig verwisselbaar



Bestell-No./Order-No.	Art. No.	Ø mm	g	mm
new 50816131000	5081613-10	150	110	10

5081613-20

Sägeblätter-Set für Metall, 5-tlg.

- Geeignet für HEYTEC Multifunktion Handsäge Art. No. 5081613
- Hochwertige Sägeblätter, Zähne induktiv gehärtet
- Sägeblatt für Metall 6"X10T
- Sicherer Halt und einfacher Austausch des Sägeblattes

Assortiment 5 lames de scies pour métal

- Convient pour HEYTEC scie à main multifonction Art. 5081613
- Lames d'acier de qualité supérieure, denture trempée par induction
- Lame de scie pour bois 6"X10T
- Remplacement facile de la lame de scie

Set zaagbladen voor Metall, 5 stuks

- Geschikt voor HEYTEC multifunctionele handzaag, art.nr. 5081613
- Hoogwaardige zaagbladen, tanden inductief gehard
- Zaagblad voor hout 6"X10T
- Stevige vergrendeling en eenvoudig verwisselbaar

new



Bestell-No./Order-No.	Art. No.	CLD mm	g	
new 50816132000	5081613-20	150	110	10

5081613-30

Handgriff für Multifunktion Handsäge

- Besonders geeignet für schwer zugängliche Stellen
- Griff in zwei Winkel einstellbar, einfache Handhabung
- Hochwertiger 2-K Kunststoff-handgriff
- Der Griff nimmt sowohl Säbelsägeblätter mit 1/2" Standardaufnahme als auch 1/4" Standardbits auf

Poignée pour scie à main multifonction

- Lame extra fine – spécialement adaptée pour les zones difficiles d'accès
- Deux angles réglables, manipulation facile
- Manche en plastique 2-C de haute qualité
- La poignée est constituée pour des lames alternative 1/2" et des embouts hexagonaux standard de 1/4"

Greep voor multifunctionele handzaag

- Ideaal voor moeilijk bereikbare plaatsen
- Greep in 2 standen verstelbaar, eenvoudig te gebruiken
- Hoogwaardige 2-comp. kunststof greep
- Greep is geschikt voor 1/2" reciprozagen en 1/4" bits

new



Bestell-No./Order-No.	Art. No.	CLD mm	g	
new 50816133000	5081613-30	160	200	5

5081610

Metallbügelsäge

Mit Schnellspannvorrichtung
300 mm/12" Blattlänge, Profi-
Qualität mit ergonomischem
2-K Griff, geprüfte Qualität

Sägeblatt in verschiedene Winkel
verstell- und arretierbar

Monture de scie à métaux

À serrage rapide, larne
de 300 mm/12",
qualité professionnelle avec
poignée à 2 composantes,
qualité certifiée

Lame réglable et verrouillable
dans différents angles

Metaalzaagbeugel

Met snelspanklem, 300 mm/12"
zaagblad, professionele kwaliteit
met ergonomische 2 componenten
greep, kwaliteit getest

Zaagblad in verschillende hoeken
verstel- en draaibaar



Lieferumfang mit
1 Sägeblatt Metall (24T/1")
1 Sägeblatt Kunststoff/Holz (18T/1")

Included in delivery
1 saw blade for steel (24T/1")
1 saw blade for plastics/wood (18T/1")

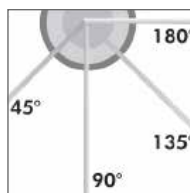

Bestell-No./Order-No.	Art. No.	☒ mm	⚖ g	📦
5081610000	5081610	300	530	1
5081610100	5081610-1	300 für Stahl (24T/1") *	200	1
5081610200	5081610-2	300 für Kunststoff/Holz (18T/1") *	200	1

* 300 mm for steel · Pour l'acier
300 mm for plastics/wood · Pour en plastique et en bois
Sägeblätter 10 Stk. im Set · Saw blades 10 pcs. in the set · Jeu de 10 lames de scie

5081612

Mini Metallbügelsäge

Mit Schnellspannvorrichtung
150 mm/6" Blattlänge, Profi-
Qualität mit ergonomischem
2-K Griff, geprüfte Qualität

Sägeblatt in verschiedene Winkel
verstell- und arretierbar

Mini-monture de scie à métaux

À serrage rapide, lame de
150 mm/6", qualité
professionnelle avec poignée
à 2 composantes, poignée
ergonomique, qualité certifiée

Lame réglable et verrouillable
dans différents angles

Juniorzaagbeugel

Met snelspanklem 150 mm/6"
zaagblad, professionele kwaliteit
met ergonomische 2 componenten
greep, kwaliteit getest

Zaagblad in verschillende hoeken
verstel- en draaibaar

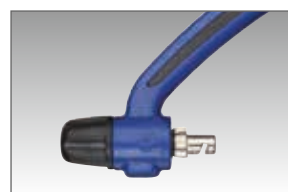
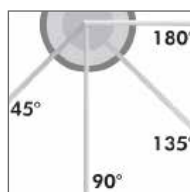

Bestell-No./Order-No.	Art. No.	☒ mm	⚖ g	📦
5081612000	5081612	150	180	1
5081612100	5081612-1	150 für Stahl (24T/1") *	30	1
5081612200	5081612-2	150 für Kunststoff/Holz (18T/1") *	30	1

* 150 mm for steel · Pour l'acier
150 mm for plastics/wood · Pour en plastique et en bois



Für jede Anwendung das richtige Equipment

Ob auf der Baustelle oder beim täglichen Einsatz im Reparaturservice – Werkzeuge brauchen einen angemessenen Stauraum, um transportiert werden zu können. In der oftmals rauen Arbeitswelt haben sich unsere Taschen dafür hervorragend bewährt. Sie bieten nicht nur eine übersichtliche Anordnung der Werkzeuge, sie sind darüber hinaus extrem robust und, was besonders wichtig ist, sie bieten einen enormen Tragekomfort. Durchdacht bis ins Detail, zeichnen sich unsere Taschen durch universelle Bestückungsmöglichkeiten aus, sodass sie in nahezu allen Handwerksbereichen optimal eingesetzt werden können.

The right equipment for every job

Whether on a building site or for the everyday tasks of repair services – tools need to be appropriately stowed for transportation. Our tool bags have proved their outstanding robustness and resilience in often harsh working conditions. They not only offer clear organisation of the tools, they are also extremely robust and, especially important, offer outstanding carrying comfort. Down to even the smallest details, our bags for universal tool stowage are designed and manufactured to provide outstanding practicality in almost all trades and industry segments.





DURCHDACHT BIS INS DETAIL
PERFECTION IN EVEN THE SMALLEST DETAILS



508807-1

Bohrmaschinen-Gürteltasche, leer

Aus hochwertigem Polyester, für Akkuschrauber, Bohrmaschinen oder Bohrschrauber, gepolstert mit Sicherungsschnalle



Sac de ceinture pour perceuse, vides

En polyester de haute qualité, pour tournevis à batterie, perceuse, rembourré et équipé d'une boucle de sécurité

Boormachine gereedschapschort, leeg

Van hoogwaardig polyester, voor accuschroefmachines, boormachines of schroefboormachines, gepolstert, met veiligheidsclip



Bestell-No./Order-No.	Art. No.	Maße · Dimensions		
50880700100	508807-1	160 x 360 x 90 mm	217	1

508807-2

Gürteltasche, leer

Aus hochwertigem Polyester, gepolstert mit Hammerring, viel Platz für Werkzeug und Kleinteile sowie Aufnahmepunkt für Maßbänder und Halter für Isolierbandrollen. Ideal für Elektriker, Zimmermänner und Sanitär.



Sac de ceinture, vides

En polyester de haute qualité, avec bague de suspension pour marteau, beaucoup de place pour les outils et les petites pièces et attache pour mètre-ruban. Idéal pour électriciens, charpentiers et plombiers.

Gereedschapsschort, leeg

Van hoogwaardig polyester, gepolstert, met hamerbeugel, veel ruimte voor gereedschap en kleine onderdelen, met opbergvak voor rollbandmaten en houder voor isolatietape. Ideaal voor elektriciens, timmerlieden en loodgieters.



Bestell-No./Order-No.	Art. No.	Maße · Dimensions		
50880700200	508807-2	380 x 300 x 100 mm	344	1

508807-3

Gürteltasche, leer

Aus hochwertigem Polyester, Facheinteilung für Zangen, Schraubendreher, Bandmaß und Halter mit Isolierbandrollen. Ideal für Elektriker, Zimmermänner und Sanitär.

Sac de ceinture, vides

En polyester de haute qualité, emplacements pour pinces, tournevis, mètre-ruban et support pour rouleaux de bandes isolantes. Idéal pour électriciens, charpentiers et plombiers.

Gereedschapsschort, leeg

Van hoogwaardig polyester, vakindeling voor tangen, schroevendraaiers, rolbandmaat en houder voor isolatietape. Ideaal voor elektriciëns, timmerlieden en loodgieters.



Bestell-No./Order-No.	Art. No.	Maße · Dimensions	g	
50880700300	508807-3	460 x 270 x 320 mm	344	1

508807-4

Hammer-Gürteltasche, leer

Aus hochwertigem Polyester mit schwenkbarem Stahlbügel für alle Hammertypen inklusive Halterung für Gerüstbauknarren

Sac de ceinture pour marteau, vides

En polyester de haute qualité avec étrier en acier orientable pour tous types de marteaux et supports pour cliquets de monteurs

Hamerholster, leeg

Van hoogwaardig polyester met zwenkbare stalen beugel voor alle typen hamers, incl. houder voor werfpunratel



Bestell-No./Order-No.	Art. No.	Maße · Dimensions	g	
50880700400	508807-4	280 x 170 x 90 mm	500	1

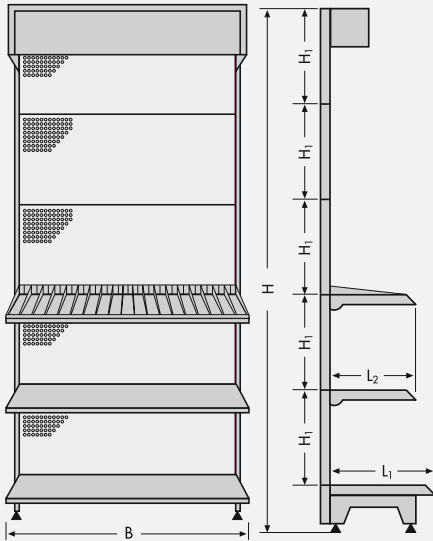

$B = 665 \cdot 1000 \cdot 1250 \cdot 1333 \text{ mm}$
 $H = 1410 \cdot 1610 \cdot 2010 \cdot 2210 \cdot 2410 \text{ mm}$
 $H_1 = 400 \text{ mm}$
 $L_1 = 570 \text{ mm}$
 $L_2 = 250 \cdot 300 \cdot 370 \cdot 470 \text{ mm}$





Ausstellungs- und Verkaufslöchwände

Verkaufsfördernde Maßnahmen. Mit unseren Verkaufswänden erfüllen wir den gehobenen Anspruch von Händler und Anwender.

Auf Anfrage stellen wir Ihnen gerne eine auf Ihre Bedürfnisse zugeschnittene Präsentation zur Verfügung.

5 Bausteine für erfolgreiche Warenpräsentation:

- Top-modisches Design
- Anschauliche Anwendungsbeispiele
- Herausgestellte Besonderheiten
- Bedarfsgerechte Bestückung
- Einheitliches Erscheinungsbild

Exhibition and sales displays

Measures for sales promotion. Our displays fulfil highest demands of traders and users.

A suitable presentation meeting your particular requirements can be provided on demand.

5 elements for successfull presentation:

- Advanced design
- Examples for applications
- Exposed features
- Assortment as per market demand
- Consistent appearance



Nummernliste		Liste des references		Nummerlijst			
Code	EAN 4024089 +	Code	EAN 4024089 +	Code	EAN 4024089 +	Code	EAN 4024089 +
01128110200	172041	50800131580	325829	50810004180	331738	50811292500	342079
50214500100	394252	50800131780	325836	50810005080	331752	50811292600	395716
50214500200	394269	50800141580	170634	50810006080	170917	50811292700	395723
50253320834	058260	50800161780	170641	50810007080	170900	50811292800	355093
50720008080	123869	50800161880	325843	50810008080	170894	50811300120	399684
50720009080	123852	50800171980	173680	50810009080	170887	50811302600	406092
50720010080	123845	50800181980	170658	50810010080	170870	50811302700	406115
50720011080	123838	50800192280	325850	50810011080	170863	50812001842	345261
50720012080	123821	50800202280	170665	50810011380	408072	50812001888	370539
50720013080	123814	50800212380	170672	50810012080	170856	50812082042	345223
50720014080	123807	50800242780	170689	50810013080	170849	50812082088	370522
50720015080	123791	50800252880	170696	50810014080	170832	50812092042	345230
50720016080	123784	50800273080	173673	50810015080	170825	50812092088	370492
50720017080	123777	50800303280	170702	50810016080	170818	50812121842	345254
50720018080	123760	50800323680	370652	50810017080	170801	50812121888	370508
50720019080	123753	50800330683	332353	50810018080	170795	50812131642	345247
50720022080	364866	50800364180	370669	50810019080	170788	50812131688	370485
50720024080	364873	50800414680	391428	50810020080	170771	50812201688	370515
50720027080	364897	50800644080	345902	50810021080	170764	50812211900	370775
50720600080	125818	50800747080	334012	50810022080	170757	50812412213	332179
50720600180	128895	50800844080	174168	50810024080	170740	50812412513	388190
50720600280	133394	50800944080	171198	50810027080	170733	50812422013	385960
50720600380	325560	50800947080	171181	50810030080	170726	50812590000	376470
50725008080	169911	50801329080	364859	50810032080	170719	50812590100	380347
50725009080	169928	50801329100	417869	50810036080	370676	50812591200	379211
50725010080	169935	50805060780	324204	50810041080	371291	50812650000	393316
50725011080	169942	50805080980	324228	50810061980	331578	50812670000	393323
50725012080	169959	50805101180	324235	50810062180	331585	50812802550	356144
50725013080	169966	50805101380	340570	50810062280	331592	50813301020	358995
50725014080	169973	50805121380	324242	50810062380	331608	50813301520	359008
50725015080	169980	50805141580	324259	50810062480	331615	50813311020	386127
50725016080	169997	50805161780	324266	50810062680	331622	50813311520	386011
50725017080	170009	50805171980	340587	50810062780	331639	50813380080	347586
50725018080	170016	50805181980	324273	50810062980	331646	50813380280	347319
50725019080	170023	50805192280	386554	50810063080	331653	50813380380	347333
50725022080	170030	50805202280	324280	50810063280	331660	50813380480	347340
50725024080	170047	50805212380	324297	50810063480	406610	50813380580	347357
50725027080	364903	50805242780	324303	50810063580	331677	50813380680	347364
50725030080	364910	50805252880	324310	50810063680	331684	50813380880	347371
50725032080	364927	50805303280	324327	50810063880	331691	50813381080	347388
50725600080	174571	50805420680	347494	50810064180	331707	50813382580	347326
50725600180	174588	50805420780	347500	50810064680	331714	50813406280	347067
50725600280	174953	50805420880	347517	50810065080	331721	50813438280	347074
50725600380	304428	50805420980	347524	50810065580	406627	50813448280	386936
50725600580	392944	50805421080	347531	50810066080	406634	50813470080	347593
50730081383	348224	50805421180	347548	50810131080	329254	50813471080	347395
50730091583	348231	50805421280	347555	50810140180	394214	50813471580	347401
50730101983	363166	50805421380	347562	50810520000	405279	50813472080	347418
50730161983	348248	50805425580	347487	50810522700	409000	50813472580	347425
50730202483	348255	50805429080	356267	50810522800	409017	50813472780	347432
50730600183	348262	50805644080	347654	50810525000	409031	50813473080	347449
50740192236	166941	50805747080	331844	50810529200	409024	50813474080	347456
50742192280	394047	50805944080	324334	50810627380	345896	50813474580	347463
50750010080	061956	50805947080	324341	50810724280	325188	50813475080	347470
50750010080	061956	50807694500	346633	50810727180	307986	50813486280	347050
50750010180	061963	50807696100	416282	50810727280	307962	50813488280	347043
50750010180	061963	50807696200	416275	50810729480	339574	50813498280	386943
50780809580	339086	50807740100	416244	50810824280	174175	50814240050	306682
50800021200	334005	50807740200	416237	50810827180	174151	50814260000	368833
50800060780	170597	50807740300	416220	50810924280	171143	50814280000	394245
50800080980	170603	50807740400	416312	50810927180	171150	50814400000	356762
50800081080	325805	50807764600	363357	50810927280	311105	50814900000	369076
50800101180	170610	50807892000	384956	50810929080	171167	50814910400	368840
50800101380	173697	50810000680	331776	50810929480	171174	50814910500	368857
50800111380	314014	50810003080	331769	50811290120	326604	50814910600	368864
50800121380	170627	50810004080	331745	50811291500	341997	50814910800	368871

Code	EAN 4024089 +	Code	EAN 4024089 +	Code	EAN 4024089 +	Code	EAN 4024089 +
50814911000	368888	50817900120	428148	50825330383	331110	50833046500	387315
50814912000	368949	50817910000	373387	50825350183	330069	50833200000	327465
50814913000	368956	50817910100	373394	50825350283	330076	50833201000	390711
50814920400	368895	50817910200	386912	50825350383	331127	50833300000	381528
50814920500	368901	50817910300	390629	50825370883	331141	50833300100	381535
50814920600	368918	50817912200	387292	50825371083	331134	50833301000	390698
50814920800	368925	50817912300	390636	50825371583	330083	50833400000	387407
50814921000	368932	50817919000	374674	50825372083	330090	50833401200	390704
50814922000	368963	50818350000	360592	50825372583	330106	50833500000	404357
50815003880	334357	50818350100	402353	50825372783	330113	50833900000	371437
50815005080	364972	50818360000	406658	50825373083	330120	50834000000	368970
50815013800	334364	50818393000	386356	50825374083	331158	50834000100	368987
50815015000	364989	50818393200	386417	50825501583	328639	50834300700	369014
50815160021	353747	50820064600	416213	50825506583	395518	50834310800	369021
50815160120	365139	50820077100	416206	50825600483	330137	50834320400	369007
50815181021	331547	50820077200	416190	50825600583	330144	50834350200	369038
50815230021	326208	50820160900	404876	50825600683	330151	50834370900	368994
50815250021	326215	50820161483	405620	50825600783	330168	50835000000	402377
50815302700	371239	50820176200	416183	50825600883	330175	50839000100	202571
50815303500	371208	50822500780	356786	50825600983	330182	50839000680	176940
50815312700	371277	50825006583	395495	50825601083	330199	50839000880	176933
50815313500	371284	50825015083	329872	50825601183	330205	50839001080	177206
50815322700	371253	50825017083	364088	50825601283	330212	50839001088	371680
50815323500	371260	50825018083	369045	50825601383	330229	50839001280	313512
50816100000	361933	50825018083	369045	50825601483	330236	50839900480	365870
50816101000	361919	50825030083	331011	50825601583	331165	50840015083	330267
50816102000	361926	50825040083	329889	50825604583	330243	50840030083	332360
50816110100	404340	50825050083	329896	50825605583	330250	50840040083	330274
50816120000	361940	50825055083	350104	50825700083	388541	50840041083	331189
50816121000	361896	50825056083	369052	50828301583	369649	50840060083	330281
50816122000	361902	50825057083	369069	50829000280	332131	50840101783	392210
50816130000	423327	50825060083	329902	50829000380	332117	50840121383	323955
50816131000	423334	50825080083	329919	50829000480	332100	50840140083	330298
50816132000	423341	50825101500	313451	50829000500	332124	50840140183	394177
50816133000	423358	50825101680	382303	50829000880	332162	50840150083	330328
50816210132	356410	50825101783	392203	50829000980	332155	50840150083	330328
50816402500	359664	50825111583	365887	50829001033	332292	50840150183	394184
50816403200	359626	50825121083	323948	50829001100	332094	50840190183	330335
50816404200	359640	50825150183	394160	50829001283	332193	50840190383	330953
50816430100	353419	50825190683	329926	50829001383	332209	50840301583	328653
50816430100	353419	50825190783	329933	50829001483	332285	50840600883	330359
50816430200	359848	50825190883	329940	50829001542	348163	50840600983	330366
50816430200	359848	50825190983	329957	50829001680	350241	50840601083	330373
50816430300	361872	50825191083	329964	50829001783	350654	50840601183	330380
50816431500	361643	50825191183	329971	50829001800	381283	50840601283	330397
50816432200	359633	50825191283	329988	50829001800	381283	50840601383	330403
50816464200	380071	50825191383	329995	50829001986	386431	50840601483	330410
50816470000	380064	50825191483	331028	50829003083	346602	50840601583	330427
50816473500	380057	50825200483	345933	50829003100	346572	50840601683	330434
50816480000	380422	50825200583	345940	50829003200	346589	50840601783	330458
50816480200	380439	50825200683	345957	50829003380	346619	50840601883	330472
50816680000	370553	50825200783	345964	50829003480	346596	50840601983	330489
50816690000	362633	50825200883	345971	50829003580	346626	50840602083	331196
50816691200	362640	50825201083	345988	50829005000	394757	50840602183	330496
50816700800	386929	50825201183	345995	50829005100	394801	50840602283	330502
50816752000	359961	50825300383	330007	50829005200	394795	50840602483	331202
50816762000	359978	50825300483	330014	50829005300	394825	50842301583	388206
50816772000	359985	50825300583	331035	50829005400	394771	50845110133	375633
50816782000	359992	50825301583	328646	50829005500	394764	50845110180	326468
50816792000	360004	50825310183	330021	50829005600	394788	50845110233	375626
50816800500	360011	50825310283	330038	50829005700	394863	50845110280	326475
50817200000	356847	50825310383	330045	50829301683	381009	50845110333	375619
50817300000	356830	50825310483	330052	50829301783	353099	50845120133	332261
50817310000	380248	50825320183	331042	50829301883	365658	50845120180	409406
50817320000	385847	50825320283	331059	50829301983	389975	50845120233	332278
50817330800	386875	50825320383	331066	50829302083	423211	50845120280	409413
50817330900	386882	50825330183	331103	50830000000	356854	50845120333	375640
50817560100	380231	50825330283	331097	50833010080	379235	50845151080	409260

Code	EAN 4024089 +	Code	EAN 4024089 +	Code	EAN 4024089 +	Code	EAN 4024089 +
50845151580	409277	50850310683	339857	50850363083	349351	50863000300	331790
50845152080	409284	50850310783	349290	50850364083	349368	50863001730	356816
50845152580	409291	50850310883	349306	50850364583	349375	50863001760	332001
50845152780	409307	50850310983	349313	50850365083	349382	50863001930	356823
50845153080	409314	50850311083	350159	50850365583	349399	50863001960	332018
50845154080	409321	50850311183	339987	50850366083	349405	50863002130	358681
50845300480	326437	50850311283	339970	50850367083	349412	50863002160	332025
50845305580	326444	50850311383	350128	50850372083	340020	50863002230	358698
50845306580	326451	50850311483	339956	50850372583	340037	50863190300	331806
50845361033	332230	50850311583	339963	50850372783	340044	50863191730	356793
50845361233	332247	50850311683	350135	50850373083	331240	50863191760	332032
50845367533	332223	50850311783	350142	50850374083	331257	50863191930	356809
50845500033	387995	50850311883	339994	50850374583	331264	50863191960	332049
50845600080	409338	50850311983	350166	50850375083	331271	50863192160	332056
50845640080	387988	50850312283	350173	50850375583	349801	50867500000	395228
50846000033	369113	50850312483	350180	50850376083	349818	50868000000	355086
50847000033	373677	50850312583	350197	50850456083	375251	50870301583	341935
50848002600	381252	50850312683	350203	50850520083	346350	50870311583	341942
50848002700	381238	50850312783	350210	50850530083	346367	50872301583	348590
50848010000	380088	50850330183	349665	50850540083	346374	50873301583	348583
50849001100	371994	50850330283	349672	50850550083	346381	50879000080	364811
50849001400	377842	50850330383	349689	50850551283	346398	50880000020	395488
50849401680	410419	50850330483	349696	50850560283	346428	50880000080	348156
50850006583	395501	50850330583	349702	50850580083	405798	50880700100	364774
50850015083	330519	50850330683	349719	50850590083	346411	50880700200	364781
50850030083	332377	50850330783	349726	50850600883	331288	50880700300	364798
50850040083	330526	50850331283	349894	50850600983	331295	50880700400	364804
50850045083	350081	50850331483	349900	50850601083	330649	50881000600	390490
50850046083	375237	50850331583	349917	50850601183	330656	50882000080	307337
50850050083	330540	50850331683	349863	50850601283	330670	50883301683	381030
50850055083	350098	50850332183	349733	50850601383	330687	50884301583	346176
50850055483	394023	50850332283	349740	50850601483	330694	50885000080	176957
50850055583	394030	50850332383	349757	50850601583	330700	50886000080	371307
50850056083	375244	50850332483	349764	50850601683	330823	50890300200	339567
50850060083	330557	50850332583	349771	50850601783	330717	50890300300	381269
50850101680	382310	50850332683	349788	50850601883	330724	50895100080	371413
50850101783	392227	50850332783	349795	50850601983	330731	50895311380	371321
50850121983	323962	50850340183	349528	50850602083	330748	50895311480	371338
50850140183	394191	50850340283	349535	50850602183	330755	50895311780	371345
50850141083	331219	50850340383	349542	50850602283	330762	50895311880	371352
50850141083	331219	50850340483	349559	50850602383	331301	50895311980	371369
50850150183	394207	50850340583	349566	50850602483	330779	50895312280	371376
50850190183	330564	50850340683	349573	50850602783	330786	50895312480	371383
50850190383	330571	50850340783	349580	50850603083	330793	50895312780	371390
50850190383	330571	50850342183	349597	50850603283	330816	50895313080	371406
50850191083	330588	50850342283	349603	50850603483	433890	50898101260	339550
50850191383	330595	50850342383	349610	50850603683	433906	50958171980	144185
50850191483	330601	50850342483	349627	50850631983	382143	58103000100	164336
50850191583	330618	50850342583	349634	50850632183	382150	90050160083	074857
50850191783	330625	50850342683	349641	50850632383	382167	90050160083	074857
50850191983	330632	50850342783	349658	50850632583	382174	90050400080	142389
50850192283	331226	50850360383	349825	50850632783	382181	90833120305	331530
50850192483	331233	50850360483	349832	50850632983	382198	90833140005	387858
50850201083	346008	50850360683	349849	50850633183	382204	90880701500	331486
50850201183	346015	50850360883	349856	50850633383	382211	90950103220	144192
50850201283	346022	50850361083	349429	50850633483	382228	90955020020	144215
50850201483	346039	50850361183	349436	50850633583	382235	98076080020	089257
50850201683	346046	50850361283	349443	50850633783	382242	98263060080	090949
50850201883	346053	50850361383	349450	50850633883	382259	98718250000	387834
50850202083	346060	50850361483	349467	50850633983	382266	98718500000	387841
50850202283	346077	50850361583	349474	50850634083	382273		
50850202483	346084	50850361683	349481	50850634183	382280		
50850310083	349276	50850361783	349498	50850790083	388558		
50850310183	349283	50850361883	349504	50851301583	328677		
50850310283	339819	50850361983	349511	50852201683	381016		
50850310383	339826	50850362083	349320	50853301583	328660		
50850310483	339833	50850362583	349337	50854301683	381023		
50850310583	339840	50850362783	349344	50860301580	318913		

Inhaltsverzeichnis

Artikel	
A	
Abdeckhaube für Werkstattwagen	82
Abisolierzange	129/133
Abzieher	139
Adapter 1/4"	36/38
Adapter 3/8"	45/46
Adapter 1/2"	52
Adapter 3/4"	75
Adapter für Knarren-Ringmaulschlüssel	27
Arbeitshandschuhe	173
B	
Bandmaß	137
Bit-Adapter	39
Bit-Box-Satz	36-38
Bithalter	145
Bit-Knarre 1/4"	31
C	
Crimpzange	130
Cuttermesser	136
D	
Doppelmaulschlüssel	16/17
Doppelringschlüssel	22
Drahtsäge	168
Drehmomentschlüssel	107/108
Dreikant-Rohrsteckschlüssel	153
Durchsteckknarre 1/2"	49/169
Durchsteckknarre 3/4"	74
E	
Eckrohrzangen	113
Einmaulschlüssel	19
Einsatzspender	60/61
Einsteckknarre 1/2"	108
Einsteckmaulschlüssel 1/2"	108
Express-Schlüssel	168
F	
Feinmechaniker-Bitsatz	141
Feinmechaniker-Schraubendrehersatz	141
Flachrundzange	113/114
Forestman	92
Fugenabzieher	164
G	
Gerüstbauknarre	27/28
Gewindeschneidwerkzeug	140
Gleitstück	45/52
Greifzange	112
Griff mit Gleitstück 1/4"	32
Griff mit Gleitstück 3/8"	44
Griff mit Gleitstück 1/2"	51
Griff mit Gleitstück 3/4"	74
Gripzange	118
Gürteltaschen	180/181
H	
Hämmer	151/152
Handhebelfettpresse	164
Handsäge	175/176

Artikel	
Hebelblechschere	118
Hebelumschaltknarren 1/2"	50
Hebelumschaltknarren 1/4"	28-31
Hebelumschaltknarren 3/8"	44
I	
Impact-Steckschlüssel	111/112
J	
Japansäge	174
JUNIOR Werkzeugkasten	96
K	
Kabelmesser	134
Kantenzange	115
Kapsel-Gehörschutz	173
Kardangelenke 1/4"	33
Kardangelenke 3/8"	45
Kardangelenke 1/2"	52/170
Kartuschenpistolen	162/163
Knarren 1/4"	28-31
Knarren 3/8"	44
Knarren 1/2"	50
Knarren-Ringmaulschlüssel	24-27
Kneifzange	115
Kombinationszange	113
Kraftseitenschneider	114
Kugelpf-Winkelschraubendrehersatz	148
Kupferrohrrbürste	168
L	
Leiste für Steckschlüsseleinsätze 1/4"	34
Leiste für Steckschlüsseleinsätze 1/2"	53
M	
Magnetisierer / Entmagnetisierer	150
Metallbügelsäge	177
Module für Werkstattwagen	83-90
Montage-Werkzeugkasten	96-99
Montage-Werkzeugkoffer	102
Montage-Werkzeugsortiment im Rucksack	105
Montage-Werkzeugsortiment in Umhängetasche	103
Montage-Werkzeugsortiment L-Boxx®	100/101
Montiereisen	154
Multifunktionszange	117
Ö	
Ölbrennerschlüssel	171
Ölfilter-Bandschlüssel	154
Ölfilterspinne	154
R	
Rabitzzange	115
Radwechsel-Werkzeugsatz	110
Ringmaulschlüssel	20/21
Rohrabschneider	166/167
Rohrentgrater	167
Rucksäcke	104/106/ 21/122
S	
Sägeblätter	175/176
Sanitär Werkzeugkasten	156

Inhaltsverzeichnis

Artikel	
Sanitär-Garnitur	170
Sanitärkreuzschlüssel	171
Sanitär-Werkzeugsortiment L-Boxx®	160/161
Sanitär-Werkzeugsortimente	158/159
Saugheber	165
Schlauchschneidezange	118
Schraubendreher	143
Schraubendreher-Einsätze 1/4"	35
Schraubendreher-Einsätze 1/2"	58/59
Schraubendreher-Einsatz-Sortimente	69-73
Schutzbrille	173
SDS-Adapter	39
Sechskant-Schraubendreher	146/147
Seitenschneider	114
Spannungsprüfer	131/133
Splinttreibersatz	139
Stablampe	119
Standhahnmuttern-schlüssel	171
Steckgriff	32
Steckschlüssel	145/146
Steckschlüssel- und Bitsgarnitur 1/4"	42/43
Steckschlüssel- und Ringmaulschlüsselgarnitur 1/2"	69
Steckschlüsseleinsätze 1/4"	33/34
Steckschlüsseleinsätze 3/8"	46/53/75
Steckschlüsseleinsätze 1/2"	53/56/57
Steckschlüsseleinsätze 3/4"	75
Steckschlüsselgarnituren 1/4"	39/40/43
Steckschlüsselgarnituren 3/8"	47
Steckschlüsselgarnituren 1/2"	62-64/66-68/73
Steckschlüsselgarnituren 3/4"	76
Stirnleuchte	119
Stufenschlüssel	169/170
T	
Taschen	124/125/ 153/180
T-Griff mit Knarrenfunktion 1/4"	30/40
TORX®-Schraubendreher	144/148/149
TORX®-Winkelschraubendreher	149/150
U	
Umhängetaschen	123
Umschaltknarre 3/4"	74
Universal-Schere	115
V	
VDE Abisolierzange	129
VDE Einmaulschlüssel	133
VDE Flachrundzange	128
VDE Kombinationszange	128
VDE Kraftseitenschneider	129
VDE Schraubendreher	132
VDE Seitenschneider	129
VDE Werkzeugsätze	125-127
Verbindungsvierkant	49/169
Verlängerungen 1/4"	32
Verlängerungen 3/8"	45
Verlängerungen 1/2"	51

Artikel	
Verlängerungen 3/4"	74
Verlängerungen mit LED-Licht 1/2"	51
W	
Wasserwaage	135
Werkstattfeilen	137/138
Werkstattwagen mit Modulen	78-81
Werkstattwagen Zubehör	82
Werkzeugrolltasche	153
Werkzeugsatz mit Meißel, Körner, Splint- und Durchtreiber	138
Winkelschraubendreher	147
Z	
Zimmermannswinkel	136
Zündkerzeneinsätze 3/8"	47
Zündkerzeneinsätze 1/2"	57

Index

Article	
A	
Adapter for combination ratchet wrenches	27
Adjustable wrenches	19
B	
Backpacks	104/106/ 21/122
Basin wrench	171
Belt pouch	124/125/ 153/180/181
Bit ratchet 1/4"	31
Bit-Adapter	39
Bit-box-set	36-38
Bitholder	145
C	
Cable folding knife	134
Carpenter's square	136
Chisel and pin punch set	138
Combination plier	113
Combination ratchet wrenches	24-27
Combination stepped key	169/170
Combination wrenches	20/21
Compound action snips straight	118
Construction tool case	102
Converter 1/2"	52
Converter 1/4"	36/38
Converter 3/4"	75
Converter 3/8"	45/46
Copper tube pouch	168
Crimping tool	130
D	
Diagonal cutting nipper	114
Die cutting tool	140
Double ended open jaw wrenches	16/17
Double ended ring wrenches	22
E	
Elbow pipe wrenches	113
End cutting plier	115
Engineers' files	137/138
Extension bars 1/2"	51
Extension bars 1/2"	51
Extension bars 1/4"	32
Extension bars 1/4"	32
Extension bars 3/4"	74
Extension bars 3/4"	74
Extension bars 3/8"	44
Extension bars 3/8"	45
Extension bars with LED-Light 1/2"	51
F	
Foldable ear muff	173
Forester	92

Article	
G	
Grip pliers	118
H	
Hacksaw	177
Hammers	151/152
Handsaw	175/176
Handy screeding pads	164
Hexagonal head wrench	146/147
Hexagonal head wrenches	147
High pressure grease gun	164
Hose cutting pliers	118
I	
Impact sockets	111/112
J	
Japanese Saw	174
JUNIOR Tool box	96
L	
LED Headlamp	119
LED Torchlight	119
Lever type reversible ratchet 1/2"	50
Lever type reversible ratchet 1/4"	28-31
Lever type reversible ratchet 3/4"	74
Lever type reversible ratchet 3/8"	44
L-shaped TORX®-Wrenches	149/150
M	
Magnetizer / demagnetizer	150
Measuring tape	137
Modules for workshop trolleys	83-90
Multifunction plier	117
Multigrip plier	112
N	
Nut spinner	145/146
Nylon cover for workshop trolley	82
O	
Oil burner key	171
Oil filter strap wrench	154
Open ended jaw wrench insert tools 1/2"	108
P	
Pin punches set	139
Precision bit-set	141
Precision screwdriver set	141
Professional universal scissors	115
Profi caulking guns	162/163
Protective glass	173
Protective gloves	173
Pullers	139
R	
Rail for sockets 1/2"	53
Rail for sockets 1/4"	34
Ratchet 1/2"	49/169
Ratchet 3/4"	74

Index

Article	
Ratchets 1/2"	50
Ratchets 1/4"	28-31
Ratchets 3/8"	44
Reversible ratchet heads 1/2"	108
S	
Sanitary cross wrench	171
Sanitary tool box	156
Sanitary tool set	170
Sanitary tool set L-Boxx®	160/161
Sanitary tool sets	158/159
Sanitary wrench	168
Saw blades	175/176
Scaffolding ratchet	27/28
Screwdriver socket sets	69-73
Screwdriver sockets 1/2"	58/59
Screwdriver sockets 1/4"	35
Screwdrivers	143
SDS-Adapter	39
Self-gripping oil filter wrench	154
Set of ball head hexagonal wrenches	148
Set of sockets and combination wrenches 1/2"	69
Shoulder bags	123
Sliding T-head	45/52
Snipe nose plier	113/114
Socket- and bit-set 1/4"	42/43
Socket dispenser	60/61
Socket sets 1/2"	62-64/66-68/73
Socket sets 1/4"	39/40/43
Socket sets 3/4"	76
Socket sets 3/8"	47
Sockets 1/2"	53/56/57
Sockets 1/4"	33/34
Sockets 3/4"	75
Sockets 3/8"	46/53/75
Spark plug sockets 1/2"	57
Spark plug sockets 3/8"	47
Spinner handle	32
Spirit Level	135
Square coupler	49/169
T	
T-handle with ratchet 1/4"	30/40
Tool assortment in backpack	105
Tool assortment in shoulder bag	103
Tool assortment set L-Boxx®	100/101
Tool box, cantilever type	96-99
Tool wallet	153
Torque wrenches	107/108
TORX®-Screwdrivers	144/148/149
Tower pincers	115
Tower pincers	115
Tube cutter	166/167

Article	
Tube trimming tool	167
Tubular triangular wrench	153
Tyre lever	154
U	
Universal joint 1/2"	52/170
Universal joint 1/4"	33
Universal joint 3/8"	45
Utility knife	136
V	
Vacuum lifting pad	165
VDE Adjustable wrench	133
VDE Combination plier	128
VDE Diagonal cutting nipper	129
VDE Diagonal cutting nipper, swedish pattern, DIN ISO 5749	129
VDE Snipe nose plier	128
VDE Tool sets	125-127
VDE Wire stripping pliers	129
VDE-Screwdriver	132
Voltage tester	131/133
W	
Wheel changing tool set	110
Wire saw	168
Wire stripping plier	129/133
Workshop trolley accessories	82
Workshop trolley with modules	78-81

Verkaufs-, Lieferungs- und Zahlungsbedingungen

1. Anerkennung der Verkaufs-, Lieferungs- und Zahlungsbedingungen

Unsere Verkäufe basieren auf den nachstehenden Bedingungen, wobei jeweils nur die neuesten Verkaufsunterlagen Gültigkeit besitzen. Abweichungen oder mündlich getroffene Nebenabsprachen bedürfen unserer schriftlichen Bestätigung. Bedingungen der Besteller können wir nicht anerkennen, auch dann nicht, wenn von uns nicht ausdrücklich widersprochen wird. Der Besteller erkennt durch die Erteilung seines Auftrages unsere Bedingungen an. Vertragsgültigkeit wird erst durch unsere schriftliche Auftragsbestätigung erreicht.

2. Angebote

Unsere Angebote sind freibleibend, Katalog und Preisliste sind Bestandteil unseres Angebotes. Maß- und Gewichtsangaben sowie Abbildungen, Leistungsbeschreibungen, technische Zeichnungen und Daten sind unverbindlich, sofern sie nicht ausdrücklich als verbindlich bestätigt werden, sie können jederzeit und ohne besondere Anzeige geändert werden.

3. Schutzrechte

Werkseigene Zeichnungen, Abbildungen, Photos und sonstige Unterlagen bleiben auch nach Weitergabe an den Besteller oder an Dritte unser Eigentum und unterliegen dem Urheberrecht. Ohne unsere Erlaubnis dürfen diese weder vervielfältigt noch anderen zugänglich gemacht werden. Sie sind an einem sicheren Ort aufzubewahren und auf Verlangen an uns zurückzugeben. Werden bei der Anfertigung von Waren nach Zeichnungen, Mustern bzw. sonstigen Angaben des Bestellers Schutzrechte Dritter verletzt, so stellt dieser uns von sämtlichen Ansprüchen frei.

4. Sonderanfertigungen

Bei Sonderanfertigungen behalten wir uns das Recht einer Mehr- bzw. Minderlieferung bis zu 10 % vor. Hierzu zählen ebenfalls Serienteile, die auf ausdrücklichen Wunsch des Bestellers besonders zu zeichnen sind. Der Besteller kann nicht vom Auftrag zurücktreten; besonders hergestellte oder gezeichnete Ware wird von uns nicht zurückgenommen. Im Falle von Zahlungsunfähigkeit bzw. Konkurs des Bestellers behalten wir uns das Recht vor, die Ware direkt zu verkaufen. Bei Herstellung nach Unterlagen des Bestellers haftet dieser für die Richtigkeit seiner Zeichnungen, Muster, Lehren usw. Muster werden grundsätzlich nur gegen Berechnung geliefert.

5. Preise

Unsere Preise sind freibleibend in EUR und als unverbindliche Preisempfehlung anzusehen. Sie verstehen sich ausschließlich Mehrwertsteuer, wobei der am Tage der Lieferung gültige Mehrwertsteuersatz Anwendung findet.

Eine Berichtigung unserer Preise behalten wir uns vor, sofern bis zum Tage der Lieferung Änderungen in den Grundkosten, wie Rohmaterial, Energie, Löhne usw. eintreten. Lieferungen erfolgen grundsätzlich in den im Katalog genannten Verpackungseinheiten. Kleinere oder durch die Verpackungseinheiten nicht teilbare Mengen werden lose in Papier verpackt und mit einem Aufschlag von 25 % belastet, sofern in unseren Verkaufsunterlagen kein anderweitiger Vermerk gemacht wird.

6. Zahlungsbedingungen

Unsere Rechnungen sind zahlbar Inland: 10 Tage nach Rechnungsdatum abzüglich 2 % Skonto oder 30 Tage nach Rechnungsdatum netto, falls keine anderen Vereinbarungen getroffen wurden.

Ausland: Nach besonderen Vereinbarungen; maßgebend ist der Zahlungsvermerk auf dem jeweiligen Angebot, der Proforma-Rechnung bzw. der Rechnung. Beträge unter EUR 25,- netto sind grundsätzlich nicht skontoberechtigt. Wechsel werden nur nach vorheriger Vereinbarung hereingenommen. Die Kosten der Diskontierung und Einziehung trägt grundsätzlich der Besteller. Bei Zahlungsverzug oder Stundung belasten wir Zinsen in Höhe von 2 % über dem zu diesem Zeitpunkt gültigen Diskontsatz der Deutschen Bundesbank. Die Wertstellung eingegangener Schecks und Wechsel erfolgt zu dem Tag, an dem wir über den Gegenwert verfügen können. Sollten uns nach Vertragsabschluß Umstände bekannt werden, welche die Kreditwürdigkeit des Kunden beeinträchtigen, sind wir berechtigt, Vorauszahlung oder andere Sicherheitsleistungen zu verlangen. Eine Zurückhaltung der Zahlung wegen Minderungs-, Wandlungs-, oder eventueller anderer Gegenansprüche, sowie die Aufrechnung mit solchen ist nicht zulässig.

7. Lieferung und Versand

Wenn nicht anders vereinbart, liefern wir grundsätzlich ab Werk ausschließlich Verpackung, wobei Lieferung und Versand der Ware auf Gefahr des Bestellers erfolgen. Versicherungen gegen Diebstahl, Transportschäden usw. erfolgen nur auf Wunsch und Kosten des Bestellers. Falls keine besondere Vorschrift gegeben wird, wählen wir den günstigsten Versandweg.

Waren, die zu einem vereinbarten Termin versandbereit gemeldet werden, müssen umgehend abgerufen werden, da wir andernfalls berechtigt sind, diese auf Kosten und Gefahr des Bestellers zu lagern und als geliefert zu berechnen. Für Verladungen setzen wir Netto - Mindestauftragswerte wie folgt voraus: Inland - EUR 100,-; Ausland - EUR 500,-, sofern in unseren Verkaufsunterlagen kein anderweitiger Vermerk gemacht wird. Wir behalten uns vor, Aufträge unter dieser Grenze entweder bis zum Erreichen des Mindestauftragswertes zurückzustellen oder mit einer Bearbeitungsgebühr von EUR 10,- zu belasten.

8. Eigentumsvorbehalt

Die gelieferte Ware bleibt bis zur endgültigen Bezahlung ohne Rücksicht auf den Rechtsgrund unser Eigentum. Für den Fall der Bezahlung auf Scheck-Wechselbasis bleibt der Eigentumsvorbehalt bis zur Einlösung des Wechsels durch den Besteller bestehen.

Der Besteller ist, so lange er sich nicht in Verzug oder in Zahlungsschwierigkeiten befindet, zur Veräußerung der Ware im ordnungsgemäßen Geschäftsverkehr berechtigt. Veräußert der Besteller die in unserem Vorbehaltseigentum stehende Ware, werden die durch die Veräußerung entstehenden Forderungen schon jetzt an uns abgetreten, ohne daß es im Falle der Veräußerung einer ausdrücklichen Bestätigung bedarf. Er ist nicht berechtigt, die Vorbehaltswaren zu verpfänden oder zur Sicherheit an Dritte zu übereignen.

Bis zur endgültigen und vollständigen Bezahlung der Ware steht uns das Recht zu, auch ohne Ausübung des Rücktritts und ohne Nachfristsetzung auf Kosten des Bestellers die einstweilige Herausgabe der Vorbehaltsware zu verlangen, die Räumlichkeiten des Bestellers zu betreten und die Ware nötigenfalls wieder an uns zu nehmen.

Wird eine Be- oder Verarbeitung bzw. untrennbare Vermischung der Vorbehaltsware mit anderen, nicht dem Lieferer gehörenden Gegenständen vorgenommen, so erwerben wir das Miteigentum an der neuen Sache im Verhältnis des Rechnungswertes der Vorbehaltsware zu den anderen verarbeiteten oder vermischten Gegenständen zum Zeitpunkt der Verarbeitung oder Vermischung. Wird die gelieferte Ware vom Besteller oder dessen Beauftragten verändert oder als Teil größerer Einheiten verwendet, so geht unser Eigentum anteilmäßig automatisch auf die veränderte Ware oder die entstandenen größeren Einheiten über. Der Besteller verwahrt das Eigentum oder Miteigentum für den Lieferer und ist verpflichtet, diese gegen Feuer, Diebstahl und Wasser zu versichern. Etwaige Entschädigungsansprüche, die aus Schäden vorgenannter Art gegen Versicherungsgesellschaften oder sonstige Ersatzverpflichtete zustehen, werden in Höhe unserer Forderungen an uns abgetreten. Pfändungen oder andere Beeinträchtigungen unseres Eigentums sind uns unverzüglich mitzuteilen.

Ohne die bisher dargelegten Bedingungen einzuschränken, geht das Risiko für die gelieferte Ware vom Tage der Lieferung auf den Besteller über.

9. Lieferzeit, Liefermöglichkeit

Lieferfristenangaben sind annähernd und ohne Verbindlichkeit für uns. Verzugsspesen und Schadenersatzansprüche bei Lieferverzögerungen können gegen uns in keinem Falle geltend gemacht werden. Die Lieferzeit beginnt nach Klärung sämtlicher kaufmännischer und technischer Einzelheiten. Wir sind berechtigt, Teillieferungen durchzuführen.

10. Höhere Gewalt

Streik und Aussperrung, Katastrophen, Betriebsstörungen, Materialmängel, Verkehrsmängel oder andere Ereignisse höherer Gewalt, ganz gleich ob sie bei uns oder bei unseren Vorlieferanten eintreten, entbinden uns von allen Verpflichtungen.

11. Mängelrügen

Beanstandungen werden nur entgegengenommen, wenn sie schriftlich und umgehend, d. h. sofort nach Erhalt der Sendung, angezeigt werden. Ein Recht auf Wandlung oder Minderung steht dem Besteller nicht zu. Über den Warenwert hinausgehende Ansprüche können nicht gestellt werden. Transportschäden sind stets beim Frachtführer zu reklamieren.

12. Garantie, Gewährleistung

Alle HEYTEC-Werkzeuge werden in unseren Werken sorgfältig überprüft und unterliegen voll der Garantie.

Wir ersetzen jedes Werkzeug kostenlos, das Material- oder Fertigungsfehler aufweist. Eine weitere Haftung ist ausgeschlossen. Kostenloser Ersatz erfolgt nicht, wenn die Untersuchung in unserem Werk ergibt, daß das Werkzeug unsachgemäß behandelt worden ist oder ein natürlicher Verschleiß vorliegt.

13. Haftung

Schadenersatzansprüche aus Fehlen zugesicherter Eigenschaften, Verzug, Unmöglichkeit der Leistung, schuldhafter Verletzung vertraglicher Nebenpflichten, sowie aus Verschulden bei Vertragsabschluß und aus unerlaubter Handlung werden ausgeschlossen, es sei denn, sie beruhen auf Vorsatz oder grober Fahrlässigkeit unserer gesetzlichen oder sonstigen uns zuzurechnenden Vertreter.

14. Erfüllungsort und Gerichtsstand

Erfüllungsort der Lieferung und Zahlung ist Remscheid. Gerichtsstand ist Remscheid. Es gilt das Recht der Bundesrepublik Deutschland.

15. Export und Re-Export

HEYTEC-Ware darf nur mit unserer schriftlichen Genehmigung exportiert oder re-exportiert werden.

Terms of sale, delivery and payment

1. Acceptance of terms of sale, delivery and payment

Our sales are based on the following terms and conditions whereby only the latest issue of our sales literature is valid.

Any variations to these and verbal arrangements require our confirmation in writing. Conditions of the buyer shall not be binding to us, also if not expressly objected by us. The placing of an order contract with us implies acceptance of our conditions. Validity of contract is only reached with our written order confirmation.

2. Quotations

Our offers are without obligation. Catalogue and pricelist form part of our offers. Weights and dimensions, illustrations, performance details, technical drawings and data are subject to change without prior notice, unless contracted and confirmed otherwise.

3. Copyright

All drawings, illustrations, photographs and other documents supplied by us to customers or third parties remain our property and are subject to copyright.

They are not to be reproduced or made available to others without our written consent; they are to be stored in a safe place and must be returned to us on demand. Should production of merchandise to drawings, samples or other customer's specification involve an infringement of third party copyrights the customer indemnifies us from and against all claims.

4. Special manufacture

We reserve the right to modify the quantities ordered for special production by plus or minus 10 %, also normal production items, which are marked or finished to buyer's special requirements. Such orders cannot be cancelled once accepted by us. We are unable to accept the return of such items for credit or allowance.

If the customer becomes insolvent or bankrupt we reserve the right to sell this merchandise directly. For production to customer's documents the customer shall be solely responsible for the accuracy of drawings, samples, gauges etc. On principle samples are only supplied against invoice.

5. Prices

We reserve the right to adjust prices in case there should be changes in basic production costs, such as raw material, power, wages etc. up to date of delivery.

Parts ordered will only be shipped in packing units identified in our sales literature. Smaller quantities or quantities, which are not divisible by packing units will be packed in paper only and levied with an increase of 25 % provided no other information has been given in our sales literature.

6. Terms of payment

Our invoices are payable Home market: 10 days after date of invoice less 2 % cash discount or 30 days after date of invoice net, provided no other arrangements have been agreed. Export markets: According to special arrangements, which are stated on our quotations, proforma invoices, order confirmations and/or invoices. On principle invoice values below EUR 25,- net do not qualify for cash discount. Drafts will only be accepted after prior arrangements and all charges are to buyer's account. In the event of delayed payments or respites we shall charge interests at a rate of 2 % above the bank rate of the Deutsche Bundesbank being in force at the relevant time.

The credit values of cheques and drafts received are entered for that day, when their value is at our disposal. In case we should learn about circumstances restricting the creditworthiness of the customer after a contract has been concluded, we are permitted to ask for payment in advance or other satisfactory securities.

Retention of payment due to claims of diminution, transformation or other eventual counterclaims as well as settling of accounts incorporating the above is not permissible.

7. Dispatch and delivery

Unless arranged and confirmed to the contrary delivery is effected ex works, packing excluded. Goods are delivered at buyer's risk. Insurance against theft, damages in transit etc. can be arranged on specific request and to customer's account. We reserve the right to choose the most economic method of transport unless particular instructions are given.

Goods, which have been packed to be ready for dispatch for an agreed date must be called off immediately, as otherwise we are entitled to store same at buyer's risk and cost and to invoice shipment as delivered.

For shipments our minimum net order values are - Home market EUR 100,- Export markets EUR 500,-; unless no other terms are quoted in our sales literature. Terms of Sale, Delivery and Payment. For orders with smaller values we reserve the right to postpone shipment until minimum order value is reached or to charge a handling fee amounting to EUR 10,00.

8. Title to the goods

Goods delivered remain our property until payment is received in full. It is expressly reserved that any law contradicting this clause shall not impair our rights concerning our goods. The buyer may dispose of the goods in the usual businesslike manner provided he is not insolvent or in default. Should the customer sell goods, which are still our property respective credit is due to our account automatically without express confirmation. The buyer is not entitled to distract or, as security to third parties, assign goods which are still our property.

Until paid for in full we are entitled to demand the release of goods and to enter buyer's premises with the object of re-taking possession of the goods. We are not obliged to execute withdrawal and to award postponement at customer's costs.

In case processing, further treatment or inseparable blending of provisosgoods is effected with other merchandise or parts not belonging to us, we automatically gain partial ownership on the processed goods to such value as it is in relation to the processed or blended merchandise at the moment of processing or blending. Should supplied goods through buyer or on behalf of buyer be subjected to alterations or be used as part of larger units, then automatically partial ownership is transferred to the changed merchandise or the produced larger units. The buyer storing seller's property or partial property is obliged to secure same against fire, theft and water. Eventual claims for damages against insurance companies resulting from damages mentioned before are to be assigned to us representing the amount of our claim. Distraints and/or any other limitation, which might be imposed on our property despite the reservations outlined in the proceeding sentences must be reported immediately.

Notwithstanding the conditions outlined above, goods are at the entire risk of the buyer from the date of delivery.

9. Time of delivery and delays

All information given in respect of delivery period is approximate and without obligation. Liability in case of delay in delivery, interest for delay and/or damages cannot be accepted. The time of delivery begins only after clarification of all clerical and technical details. We are permitted to effect part shipments.

10. Force majeure

Force majeure, such as strike and lock-out, catastrophes of any kind, breakdown in supply of any kind, delivery of faulty material or other restrictions through force majeure shall release us from our liabilities, no matter if occurred with us or our sub-suppliers.

11. Claims

Claims must be made immediately on receipt of the goods and in writing, as otherwise such claims will not be accepted by us. Amendments to or deductions from invoices will not be accepted. The customer is not entitled to make claims above the nominal value of the goods involved. Damages in transit are to be claimed with the carrier.

12. Guarantee, warranty

All HEYTEC tools are carefully tested before leaving our works and are fully guaranteed. We shall replace free of charge any tool indicating faults of material and workmanship. Any further liability is excluded. Tools returned as faulty, which on inspection/test prove to have failed due to abuse, incorrect use or fair wear and tear are excluded from this guarantee and replacement will be charged.

13. Liability

Claims for compensation due to missing of promised features, delays, impossibility of performance, guilty violation of contractual secondary obligations, faults with conclusion of contract as well as unauthorized action are excluded save where our legal representatives are shown to have acted on purpose or negligently.

























































Liability even for careless violation is limited to compensation, which is foreseeable at the moment of conclusion of contract.

14. Settling place and place of competency

Remscheid is the settling place for delivery, payment and competency of justice in case of dispute. Only the law of the Federal Republic of Germany shall govern.

15. Export and re-export

Only with our written approval HEYTEC goods may be exported or re-exported.

Abkürzungen, Symbole und Hinweise	Abréviations, symboles et indications	Afkortingen, symbolen en verwijzingen
<p>Alle Katalogartikel werden technisch ständig optimiert; daher sind Änderungen jederzeit und ohne Ankündigung möglich. Unsere Katalogpreise sind Grundpreise ohne Mehrwertsteuer.</p> <p>Sie sind bei Weiterverkauf durch den Handel als unverbindliche Preisempfehlung anzusehen und nicht zur Weitergabe bestimmt.</p> <p>Der Nachdruck dieses Kataloges oder Teilen daraus, die Vervielfältigung, Speicherung und Übermittlung jedweder Art, auch durch Datenverarbeitungsanlagen, sind nur mit unserer schriftlichen Genehmigung gestattet.</p>	<p>Les produits du catalogue étant soumis à des améliorations techniques permanentes, le fabricant se réserve le droit de modifier leurs caractéristiques à tout moment et sans préavis. Les prix indiqués dans ce catalogue sont des prix de base hors T.V.A. Ils sont donnés à titre indicatif aux revendeurs et ne sont pas destinés à être divulgués. Toute reproduction, copie ou diffusion totale ou partielle que ce soit, notamment par photocopie ou par équipement informatique, est interdite sans notre autorisation écrite.</p>	<p>Alle artikelen in deze catalogus worden in technisch opzicht voortdurend verbeterd; daarom zijn wijzigingen te allen tijde en zonder aanzegging mogelijk.</p> <p>Nadruk van deze catalogus of delen ervan, vermenigvuldiging, opslag en overdracht van welke aard dan ook, ook door gegevensverwerkende installaties, zijn alleen toegestaan met onze schriftelijke toestemming.</p>
 Packeinheit	 unité d'emballage	 verpakkingseenheid
 Länge	 longueur	 lengte
 Durchmesser	 diamètre	 diameter
 metrische Schlüsselweiten für Schrauben und Muttern mit Außensechskant	 ouvertures métriques pour vis et écrous hexagonaux	 metrische sleutelwijdte voor bouten en moeren met buitensechskant
 metrische Schlüsselweiten für Innensechskantschrauben	 ouvertures métriques pour vis 6 pans creux	 metrische sleutelwijdte voor binnensechskant-bouten
 Schlüsselweite bei TORX®-Schrauben	 ouvertures métriques pour vis TORX®	 sleutelwijdte bij TORX®-bouten
 Innensechskant Schon-Profil	 6 pans intérieur – profil d'usure	 Innensechskant Schon-Profil
 Innen-Doppelsechskant Schon-Profil	 12 pans intérieur – profil d'usure	 binnensechskant
 für Außen-TORX®-Schrauben	 pour vis TORX® extérieures	 voor buiten-TORX®-schroeven
 Innenvierkant	 carré femelle	 binnenvierkant
 Außenvierkant	 carré mâle	 buitenvierkant
 Außensechskant u. für Innensechskantschrauben	 6 pans mâle	 buitensechskant
 für Schlitzschrauben	 pour vis à fente	 voor sleufschroeven
 für Kreuzschlitzschrauben PHILLIPS-RECESS	 pour vis cruciformes PHILLIPS-RECESS	 voor kruiskopschroeven PHILLIPS-RECESS
 für Kreuzschlitzschrauben POZIDRIV®	 pour vis cruciformes POZIDRIV®	 voor kruiskopschroeven POZIDRIV®
 für Innen-Keilprofil-Schrauben RIBE CV	 pour vis à empreinte à créneaux RIBE CV	 voor spiebaanbouten RIBE CV
 für Innenvielzahn-Schrauben XZN	 pour vis denture multiple XZN	 voor binnenvleetschroeven XZN
 für Innen-TAMPER-TORX®-Schrauben	 pour vis TAMPER-TORX® intérieures	 voor binnen-TAMPER-TORX®-schroeven
 für Innen-TORX®-Schrauben	 pour vis TORX® intérieures	 voor binnen-TORX®-schroeven
POZIDRIV® eingetragenes Warenzeichen der Firma European Industrial Services Ltd.	POZIDRIV® marque déposée par la société European Industrial Services Ltd.	POZIDRIV® gedeponeerd handelsmerk van de firma European Industrial Services Ltd.
TORX® eingetragenes Warenzeichen der Firma CAMCAR/TEXTRON INC.	TORX® marque déposée par la société CAMCAR/TEXTRON INC.	TORX® gedeponeerd handelsmerk van de firma CAMCAR/TEXTRON INC.



Multifunktion Handsäge, 3-tlg.

- Besonders geeignet für schwer zugängliche Stellen
- Griff in zwei Winkel einstellbar, einfache Handhabung
- Hochwertiger 2-K Kunststoffhandgriff
- Der Griff nimmt sowohl Säbelsägeblätter mit 1/2" Standardaufnahme als auch 1/4" Standardbits auf
- Je ein Sägeblatt für Metall 6"X24T / Holz 6"X10T

Multifunction handsaw, 3 pcs.

- Extra thin blade - best suited for areas difficult to access
- Two angles adjustable, easy handling
- High-quality 2-K plastic handle
- Handle accepts 1/2" reciprocating saw blades and standard 1/4" hexagon bits
- Strong handle
- One saw blade for metal 6"X24T / one for wood 6"X10T

Weitere Informationen
zum Produkt siehe Seite 175

For further product information
see page 175





www.heyco-qualitaetswerkzeuge.de



HEYCO Qualitätswerkzeuge
GmbH & Co. KG
Birgden III/1
42855 Remscheid
Germany

Tel. +49 (0) 2191 205-0
Fax +49 (0) 2191 205-266
info@heyco.de
heyco-qualitaetswerkzeuge.de



Folgen Sie uns
[@heyco_qualitaetswerkzeuge](https://www.instagram.com/heyco_qualitaetswerkzeuge)

IDEMCO

W : www.idemcosb.com.my
E : idemco@idemcosb.com.my
T : +6 03-7781 7973

Code 50895090200