

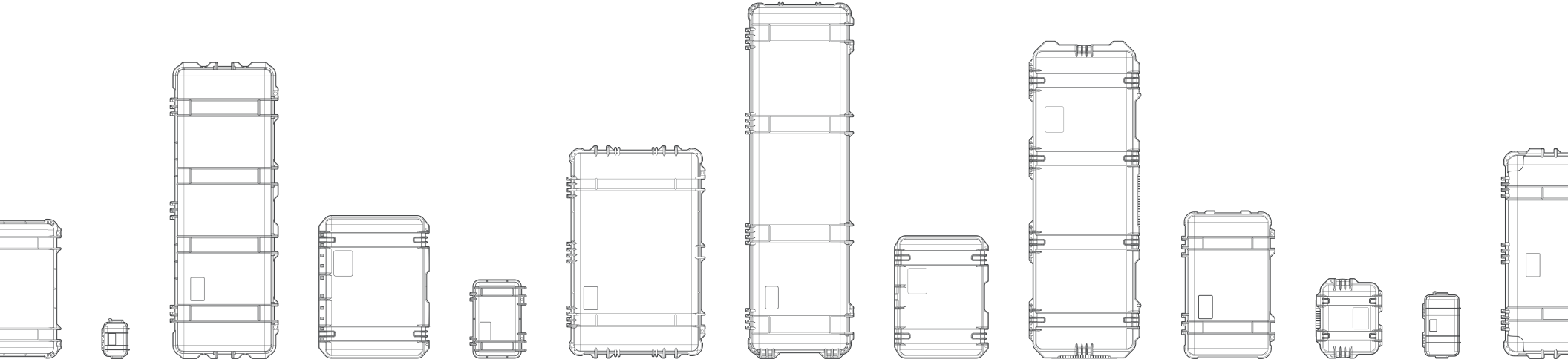

IDEMCO



2021 PELICAN™ CASE CATALOG



Dear Pelican Customer,

Our story began in a small residential garage in Torrance, California in 1976. Almost five decades later, Pelican Products, Inc. remains the global leader in the design and manufacture of high-performance protective cases.

The first Pelican case was a first-aid kit for divers, and it was so rugged and durable that other customers began to repurpose it to protect their own valuables. This began the expansion of the Pelican product line, one high-quality case at a time.

We are now manufacturing more than 1,000 different case styles, from our classic Pelican™ Protector Case™ Brand Case and Pelican™ Storm Case™ Series lines, to our innovative Pelican™ Air cases. We also offer a wide range of interior organization solutions, including our TrekPak™ divider system, padded dividers, EZ-CLICK™ MOLLE panels, Pick N Pluck™ foam, as well as custom foam interiors that help protect and organize valuable assets.

Our vision at **Pelican is Protecting All That You Value**. All our fantastic Pelican employees are committed to this mantra, because we know that the most valuable thing ever put in a Pelican case is TRUST.

A big source of pride here at Pelican Products, Inc. is the continued support of our loyal customers. On behalf of myself and my fellow Pelican employees around the world, we thank you for your business.

Sincerely,

Phil Gyori

Chief Executive Officer



MARKETS SERVED //

**FIRE
MILITARY
INDUSTRIAL
LAW ENFORCEMENT
OUTDOOR
CONSUMER
DIVE**



TABLE OF CONTENTS

- PELICAN™ AIR CASE SERIES 1
- PELICAN™ PUC SERIES 10
- PELICAN™ PROTECTOR CASE™ SERIES 11
- Memory Card & Micro Case Series™ 13
- Small Cases 15
- Digital Protection Cases 16
- Medium Cases 19
- Large Cases 21
- Long Cases 25
- PELICAN™ STORM CASE™ SERIES 27
- Small Cases 29
- Medium Cases 30
- Large Cases 32
- CASE SPECIFICATIONS 35
- CASE INTERIOR SIZE COMPARISON 37
- SERVICES & ACCESSORIES 39

www.pelican.com



PELICAN™ AIR CASE SERIES

UP TO 40% LIGHTER THAN OTHER POLYMER CASES

Our lightest case with the protection you need.



PELICAN™ AIR CASE COLORS AVAILABLE



PELICAN™ AIR TRAVEL CASE COLORS AVAILABLE



*Not available in all case sizes.



THE SCIENCE OF LIGHTNESS

Molded from the next generation of Pelican's lightweight HPX™ resin, a proprietary formula that rebounds without breaking, the honeycomb structural elements are actually stronger than solid polymer material.



PRESS & PULL™ LATCHES

All Pelican Air models now feature Press & Pull latches, making it easier to securely lock and open your case with a light touch.



WATERTIGHT

The secret is the tongue-and-groove fit with a polymer o-ring acting as a waterproof seal. Also, our Automatic Pressure Equalization Valve releases built-up air pressure while keeping water molecules out, resulting in a watertight case that is easy to open.



EASY RIDING

Stainless steel ball bearing wheels (on select cases) last longer and ride smoother. The nylon hub adjacent to the stainless steel resists heat resulting in less wear and tear on the polyurethane tire.



TESTED

The Pelican™ Air Case design is the result of multiple generations of refinement. This evolution is proven through submergence and other lab tests.



Icon indicates select models with wheels

DIMS: L x W x D

1465 AIR

INTERNAL DIMS:
18.62" x 9.99" x 10.93"
(47.3 x 25.4 x 27.8 cm)

EXTERNAL DIMS:
20.83" x 12.62" x 12.75"
(52.9 x 32.1 x 32.4 cm)

Cat. No. 1465AIR **WF**
Cat. No. 1465AIRNF **NF**



1465 EMS

INTERNAL DIMS:
18.62" x 9.99" x 10.93"
(47.3 x 25.4 x 27.8 cm)

EXTERNAL DIMS:
20.83" x 12.62" x 12.75"
(52.9 x 32.1 x 32.4 cm)

Cat. No. 1465EMS
Case with custom configured trays for EMS professionals.



1485 AIR

INTERNAL DIMS:
17.75" x 10.18" x 6.15"
(45.1 x 25.9 x 15.6 cm)

EXTERNAL DIMS:
19.17" x 12.80" x 6.89"
(48.7 x 32.5 x 17.5 cm)

Cat. No. 1485AIR **WF**
Cat. No. 1485AIRNF **NF**
Cat. No. 1485AIRWD **WD**
Cat. No. 1485AIRTP **TP**



1535 AIR WHEELED CARRY-ON 

INTERNAL DIMS:
20.39" x 11.20" x 7.21"
(51.8 x 28.4 x 18.3 cm)

EXTERNAL DIMS:
21.96" x 13.97" x 8.98"
(55.8 x 35.5 x 22.8 cm)

Cat. No. 1535AIR **WF**
Cat. No. 1535AIRNF **NF**
Cat. No. 1535AIRWD **WD**
Cat. No. 1535AIRTP **TP**
Cat. No. 1535AIRTPF **TPF**



ALSO AVAILABLE:
HYBRID INTERIOR
TREKPAK™ & PICK N PLUCK™

1506 AIR

INTERNAL DIMS:
18.70" x 9.40" x 7.80"
(47.5 x 23.9 x 19.8)

EXTERNAL DIMS:
20.12" x 12.02" x 8.56"
(51.1 x 30.5 x 21.7)

Cat. No. 1506AIR **WF**
Cat. No. 1506AIRNF **NF**
Cat. No. 1506AIRTP **TP**



1507 AIR

INTERNAL DIMS:
15.15" x 11.38" x 8.52"
(38.5 x 28.9 x 21.6 cm)

EXTERNAL DIMS:
16.87" x 14.10" x 9.27"
(42.8 x 35.8 x 23.5 cm)

Cat. No. 1507AIR **WF**
Cat. No. 1507AIRNF **NF**
Cat. No. 1507AIRWD **WD**
Cat. No. 1507AIRTP **TP**



1525 AIR

INTERNAL DIMS:
20.50" x 11.31" x 6.75"
(52.1 x 28.7 x 17.1 cm)

EXTERNAL DIMS:
21.96" x 13.97" x 7.49"
(55.8 x 35.5 x 19 cm)

Cat. No. 1525AIR **WF**
Cat. No. 1525AIRNF **NF**
Cat. No. 1525AIRWD **WD**
Cat. No. 1525AIRTP **TP**



1535TRVL AIR TRAVEL CASE 

INTERNAL DIMS:
20.39" x 11.20" x 7.21"
(51.8 x 28.4 x 18.3 cm)

EXTERNAL DIMS:
21.96" x 13.97" x 8.98"
(55.8 x 35.5 x 22.8 cm)

Cat. No. 1535TRVL
Case with custom configured lid organizer and with packing cubes also included.
Exclusive TRVL colors available.
Check with airline for exact measurement requirements.





Icon indicates select models with wheels

DIMS: L x W x D

1555 AIR

INTERNAL DIMS:
23.00" x 12.75" x 7.50"
(58.4 x 32.4 x 19.1 cm)

EXTERNAL DIMS:
24.76" x 15.46" x 8.24"
(62.9 x 39.3 x 20.9 cm)

Cat. No. 1555AIR **WF**
Cat. No. 1555AIRNF **NF**
Cat. No. 1555AIRWD **WD**
Cat. No. 1555AIRTP **TP**



1556 AIR

INTERNAL DIMS:
21.63" x 10.76" x 8.97"
(54.9 x 27.3 x 22.8)

EXTERNAL DIMS:
23.43" x 13.52" x 10.57"
(59.5 x 34.3 x 26.8)

Cat. No. 1556AIR **WF**
Cat. No. 1556AIRNF **NF**



1557 AIR

INTERNAL DIMS:
17.33" x 13.00" x 9.75"
(44.0 x 33.0 x 24.8 cm)

EXTERNAL DIMS:
19.18" x 15.79" x 10.50"
(48.7 x 40.1 x 26.7 cm)

Cat. No. 1557AIR **WF**
Cat. No. 1557AIRNF **NF**
Cat. No. 1557AIRWD **WD**
Cat. No. 1557AIRTP **TP**



1615 AIR WHEELED CHECK-IN

INTERNAL DIMS:
29.59" x 15.50" x 9.38"
(75.2 x 39.4 x 23.8 cm)

EXTERNAL DIMS:
32.58" x 18.40" x 11.02"
(82.8 x 46.7 x 28 cm)

Cat. No. 1615AIR **WF**
Cat. No. 1615AIRNF **NF**
Cat. No. 1615AIRWD **WD**
Cat. No. 1615AIRTP **TP**

Check with airline for exact measurement requirements.



1605 AIR

INTERNAL DIMS:
26.00" x 14.00" x 8.38"
(66 x 35.6 x 21.3 cm)

EXTERNAL DIMS:
28.87" x 16.77" x 9.12"
(73.3 x 42.6 x 23.2 cm)

Cat. No. 1605AIR **WF**
Cat. No. 1605AIRNF **NF**
Cat. No. 1605AIRWD **WD**
Cat. No. 1605AIRTP **TP**



1606 AIR

INTERNAL DIMS:
24.54" x 12.30" x 10.22"
(62.3 x 31.2 x 26)

EXTERNAL DIMS:
27.42" x 15.13" x 11.83"
(69.6 x 38.4 x 30)

Cat. No. 1606AIR **WF**
Cat. No. 1606AIRNF **NF**



1607 AIR

INTERNAL DIMS:
21.05" x 15.81" x 11.63"
(53.5 x 40.2 x 29.5 cm)

EXTERNAL DIMS:
24.13" x 18.80" x 13.25"
(61.3 x 47.8 x 33.7 cm)

Cat. No. 1607AIR **WF**
Cat. No. 1607AIRNF **NF**
Cat. No. 1607AIRWD **WD**



1615TRVL AIR TRAVEL CASE

INTERNAL DIMS:
29.59" x 15.50" x 9.38"
(75.2 x 39.4 x 23.8 cm)

EXTERNAL DIMS:
32.58" x 18.40" x 11.02"
(82.8 x 46.7 x 28 cm)

Cat. No. 1615TRVL
Case with custom configured lid organizer and with packing cubes also included.
Exclusive TRVL colors available.
Check with airline for exact measurement requirements.





Icon indicates select models with wheels

DIMS: L x W x D



1626 AIR



INTERNAL DIMS:
28.14" x 14.10" x 11.72"
(71.5 x 35.8 x 29.8)

EXTERNAL DIMS:
31.12" x 17.05" x 13.33"
(79 x 43.3 x 33.9)

Cat. No. 1626AIR **WF**
Cat. No. 1626AIRNF **NF**
Cat. No. 1626AIRWD **WD**



1637 AIR



INTERNAL DIMS:
23.43" x 17.55" x 13.25"
(59.5 x 44.6 x 33.7 cm)

EXTERNAL DIMS:
26.61" x 20.65" x 14.87"
(67.6 x 52.5 x 37.8 cm)

Cat. No. 1637AIR **WF**
Cat. No. 1637AIRNF **NF**
Cat. No. 1637AIRWD **WD**



1646 AIR



NEW

INTERNAL DIMS:
32.06" x 15.87" x 13.42"
(81.4 x 40.3 x 34.1 cm)

EXTERNAL DIMS:
35.29" x 19.00" x 15.08"
(89.6 x 48.3 x 38.3 cm)

Cat. No. 1646AIR **WF**
Cat. No. 1646AIRNF **NF**



1745 AIR



INTERNAL DIMS:
44.01" x 16.77" x 7.94"
(111.8 x 42.6 x 20.2 cm)

EXTERNAL DIMS:
46.69" x 19.36" x 8.73"
(118.6 x 49.2 x 22.2 cm)

Cat. No. 1745AIR **WF**
Cat. No. 1745AIRNF **NF**



1745BOW AIR



INTERNAL DIMS:
44.01" x 16.77" x 7.94"
(111.8 x 42.6 x 20.2 cm)

EXTERNAL DIMS:
46.69" x 19.36" x 8.73"
(118.6 x 49.2 x 22.2 cm)

Cat. No. 1745AIRBOW
Case with custom configured interior for bowhunters.
Bow and arrows not included.





PELICAN™ PERSONAL UTILITY CASE SERIES

DIMS: L x W x D

PELICAN RUCK™ CASE

OUTSIDE:

- IP68 RATED PROTECTION FROM WATER, DIRT, SNOW AND DUST
- RUBBER EXO-SKELETON
- DUAL PIVOT LATCH
- MULTIPLE EXTERNAL ATTACHMENT POINTS

INSIDE:

- SNAP IN, FLEXIBLE LID ORGANIZER
- LOOP SYSTEM WITH VELCRO® BRAND STRAPS
- CABLE ROUTING HOLE
- RIGID DIVIDER TRAY

PELICAN RUCK™ CASE COLORS AVAILABLE



R20 PELICAN RUCK™ CASE

INTERNAL DIMS:
7.07" x 3.39" x 1.95"
(18 x 8.6 x 5 cm)

EXTERNAL DIMS:
8.96" x 4.83" x 2.88"
(22.8 x 12.3 x 7.3 cm)

Cat. No. R20



R40 PELICAN RUCK™ CASE

INTERNAL DIMS:
7.63" x 4.70" x 1.90"
(19.4 x 11.9 x 4.8 cm)

EXTERNAL DIMS:
9.84" x 6.12" x 2.89"
(25 x 15.5 x 7.3 cm)

Cat. No. R40

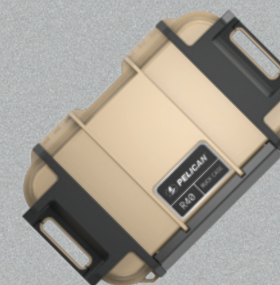

R60 PELICAN RUCK™ CASE

INTERNAL DIMS:
8.90" x 5.37" x 2.96"
(22.6 x 13.6 x 7.5 cm)

EXTERNAL DIMS:
11.14" x 6.86" x 3.88"
(28.3 x 17.4 x 9.9 cm)

Cat. No. R60



PELICAN GO™ CASE

OUTSIDE:

- IP67 RATED PROTECTION FROM WATER, DIRT, SNOW AND DUST
- RUBBERIZED PROTECTIVE BUMPER
- SINGLE LATCH CLOSURE
- EASY CARRY HANDLE
- WATERTIGHT SEAL

INSIDE:

- ORGANIZING SYSTEM FOR CARDS
- CABLE ROUTING HOLE
- RIGID DIVIDER TRAY

PELICAN GO™ CASE COLORS AVAILABLE



G40 PELICAN GO™ CASE

INTERNAL DIMS:
7.00" x 3.50" x 1.60"
(17.8 x 8.9 x 4.1 cm)

EXTERNAL DIMS:
9.45" x 5.06" x 2.05"
(24 x 12.9 x 5.2 cm)

Cat. No. G40





PELICAN™ PROTECTOR CASE™ SERIES

PROTECT WHAT MATTERS WITH MILITARY GRADE PROTECTION

No matter the job, the Pelican™ Protector Case™ Series is the standard in offering your equipment the protection it needs and deserves.



PELICAN™ PROTECTOR CASE™ SERIES
COLORS AVAILABLE

*Not available in all case sizes.



SOLID CONSTRUCTION

The Pelican™ Protector Case™ Brand Case uses an open cell core and solid wall construction, which is actually stronger and lighter than a solid core wall. Travel light with heavy protection.

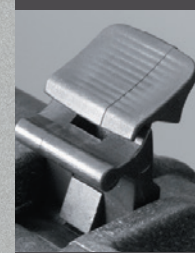

DOUBLE-THROW LATCHES

Double-Throw latches are smarter and easier to open: it's the classic 'C' clamp design with a secondary movement that works like a pry bar to start the release and offers plenty of leverage to open with a light pull.



WATERTIGHT

The secret is the tongue-and-groove fit with a polymer o-ring acting as a waterproof seal. Also, our Automatic Pressure Equalization Valve releases built-up air pressure while keeping water molecules out, resulting in a watertight case that is easy to open.

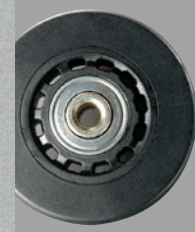

EASY RIDING

Stainless steel ball bearing wheels (on select cases) last longer and ride smoother. The nylon hub adjacent to the stainless steel resists heat resulting in less wear and tear on the polyurethane tire.



TESTED

The Pelican™ Case design is the result of multiple generations of refinement. This evolution is proven through submergence and other lab tests.

MEMORY CARD & MICRO CASE SERIES™

From small, sensitive components to smartphones, protect your gear from the elements in a Memory Card Case or Micro Case Series™ Case from Pelican.



0915 CASE

INTERNAL DIMS:
4.79" x 2.25" x 0.55"
(12.2 x 5.7 x 1.4cm)

EXTERNAL DIMS:
5.55" x 3.27" x 0.85"
(14.1 x 8.3 x 2.2cm)

Cat. No. 0915
Stores 12 SD cards or
6 mini SD cards and
6 micro SD cards.



0955 CASE

INTERNAL DIMS:
4.79" x 2.25" x 0.55"
(12.2 x 5.7 x 1.4 cm)

EXTERNAL DIMS:
5.55" x 3.27" x 0.85"
(14.1 x 8.3 x 2.2cm)

Cat. No. 0955
Holds keys, ID,
cards and cash.



G5 RF FIELD WALLET

INTERNAL DIMS:
.43" x 2.56" x 4.1"
(1.1 x 6.5 x 10.4 cm)

EXTERNAL DIMS:
.80" x 3.00" x 5.00"
(2.0 x 7.6 x 12.7 cm)

Cat. No. G5RFW
The only submersible RFID*
blocking wallet available.

* RFID: An acronym for "radio-frequency identification".
Blocking RFID prevents data theft and keeps your credit
cards safe from being electronically skimmed.



0945 CASE

INTERNAL DIMS:
4.79" x 2.25" x 0.55"
(12.2 x 5.7 x 1.4 cm)

EXTERNAL DIMS:
5.55" x 3.27" x 0.85"
(14.1 x 8.3 x 2.2 cm)

Cat. No. 0945
Stores 6 compact
flash cards.



0965 CASE

INTERNAL DIMS:
4.79" x 2.25" x 0.55"
(12.2 x 5.7 x 1.4 cm)

EXTERNAL DIMS:
5.55" x 3.27" x 0.85"
(14.1 x 8.3 x 2.2 cm)

Cat. No. 0965
Stores 6 CFexpress
and/or XOD cards.



1010 MICRO CASE

INTERNAL DIMS:
4.37" x 2.87" x 1.68"
(11.1 x 7.3 x 4.3 cm)

EXTERNAL DIMS:
5.88" x 4.06" x 2.12"
(14.9 x 10.3 x 5.4 cm)

Cat. No. 1010
Available in clear with a colored rubber
liner (in select colors) or in solid colors
with a black rubber liner. Pick N Pluck™
foam inserts are available. Visit
www.pelican.com for more details.



1020 MICRO CASE

INTERNAL DIMS:
5.31" x 3.56" x 1.68"
(13.5 x 9 x 4.3 cm)

EXTERNAL DIMS:
6.82" x 4.75" x 2.12"
(17.3 x 12.1 x 5.4 cm)

Cat. No. 1020
Available in clear with a colored
rubber liner (in select colors) or in
solid colors with a black
rubber liner. Pick N Pluck™ foam
inserts are available. Visit
www.pelican.com for more details.



1040 MICRO CASE

INTERNAL DIMS:
6.50" x 3.87" x 1.75"
(16.5 x 9.8 x 4.4 cm)

EXTERNAL DIMS:
7.50" x 5.06" x 2.12"
(19.1 x 12.9 x 5.4 cm)

Cat. No. 1040
Available in clear with a colored
rubber liner (in select colors) or in
solid colors with a black rubber liner.
Pick N Pluck™ foam inserts are available.
Visit www.pelican.com for more details.



1015 MICRO CASE

INTERNAL DIMS:
5.14" x 2.64" x 1.37"
(13.1 x 6.7 x 3.5 cm)

EXTERNAL DIMS:
6.68" x 3.88" x 1.86"
(17 x 9.9 x 4.7 cm)

Cat. No. 1015
Available in clear with black
rubber liner. Pick N Pluck™
foam inserts are available.
Visit www.pelican.com for more
details.



1030 MICRO CASE

INTERNAL DIMS:
6.37" x 2.62" x 2.06"
(16.2 x 6.7 x 5.2)

EXTERNAL DIMS:
7.50" x 3.87" x 2.43"
(19.1 x 9.8 x 6.2 cm)

Cat. No. 1030
Available in clear with black
rubber liner. Pick N Pluck™ foam
inserts are available. Visit www.
pelican.com for more details.



1050 MICRO CASE

INTERNAL DIMS:
6.31" x 3.68" x 2.75"
(16 x 9.3 x 7 cm)

EXTERNAL DIMS:
7.50" x 5.06" x 3.12"
(19.1 x 12.9 x 7.9 cm)

Cat. No. 1050
Available in clear with a colored
rubber liner (in select colors) or
in solid colors with a black rubber
liner. Pick N Pluck™ foam inserts are
available. Visit www.pelican.com for
more details.



1060 MICRO CASE

INTERNAL DIMS:
8.25" x 4.25" x 2.25"
(21 x 10.8 x 5.7 cm)

EXTERNAL DIMS:
9.37" x 5.56" x 2.62"
(23.8 x 14.1 x 6.7 cm)

Cat. No. 1060
Available in clear with a
colored rubber liner (in select
colors) or in solid colors with a
black rubber liner. Pick N Pluck™
foam inserts are available. Visit
www.pelican.com for more details.



SMALL CASES

Lightweight, but extremely strong; compact, yet fully capable. Perfect for valuable gear like hand tools and small to medium electronic components, hand-held GPS systems, and DSLR cameras. All small cases are available empty or with pre-scored Pick N Pluck™ foam.



DIMS: L x W x D

DIGITAL PROTECTION CASES

The ultimate in watertight, crushproof, and impact protected cases to transport your small electronics and other vital gear, anywhere on Earth. Digital protection cases provide the peace of mind and protection your laptops and tablets need.

1120

INTERNAL DIMS:
7.29" x 4.78" x 3.33"
(18.5 x 12.1 x 8.5 cm)

EXTERNAL DIMS:
8.41" x 6.76" x 3.87"
(21.4 x 17.2 x 9.8 cm)

Cat. No. 1120 **WF**
Cat. No. 1120NF **NF**



1150

INTERNAL DIMS:
8.29" x 5.79" x 3.75"
(21.1 x 14.7 x 9.5 cm)

EXTERNAL DIMS:
9.44" x 7.80" x 4.29"
(24 x 19.8 x 10.9 cm)

Cat. No. 1150 **WF**
Cat. No. 1150NF **NF**



1170

INTERNAL DIMS:
10.54" x 6.04" x 3.16"
26.8 x 15.3 x 8 cm)

EXTERNAL DIMS:
11.64" x 8.34" x 3.78"
(29.6 x 21.2 x 9.6 cm)

Cat. No. 1170 **WF**
Cat. No. 1170NF **NF**



1200

INTERNAL DIMS:
9.31" x 7.13" x 4.12"
(23.6 x 18.1 x 10.5 cm)

EXTERNAL DIMS:
10.67" x 9.75" x 4.86"
(27.1 x 24.8 x 12.3 cm)

Cat. No. 1200 **WF**
Cat. No. 1200NF **NF**



1300

INTERNAL DIMS:
9.17" x 7.00" x 6.12"
(23.3 x 17.8 x 15.5 cm)

EXTERNAL DIMS:
10.62" x 9.68" x 6.87"
(27 x 24.6 x 17.4 cm)

Cat. No. 1300 **WF**
Cat. No. 1300NF **NF**



1400

INTERNAL DIMS:
11.81" x 8.87" x 5.18"
(30 x 22.5 x 13.2 cm)

EXTERNAL DIMS:
13.37" x 11.62" x 6.00"
(34 x 29.5 x 15.2 cm)

Cat. No. 1400 **WF**
Cat. No. 1400NF **NF**



1075

INTERNAL DIMS:
11.11" x 7.92" x 1.63"
(28.2 x 20.1 x 4.1 cm)

EXTERNAL DIMS:
12.38" x 9.75" x 2.13"
(31.4 x 24.8 x 5.4 cm)

Cat. No. 1075 **WF**
† Designed to protect various electronic devices including external hard drives.



P1075

INTERNAL DIMS:
11.11" x 7.92" x 1.63"
(28.2 x 20.1 x 4.1 cm)

EXTERNAL DIMS:
12.38" x 9.75" x 2.13"
(31.4 x 24.8 x 5.4 cm)

Cat. No. P1075 **WF**
† Designed to fit pistols, revolvers and magazines.



1085

INTERNAL DIMS:
14.29" x 10.37" x 1.97"
(36.3 x 26.3 x 5 cm)

EXTERNAL DIMS:
15.64" x 12.41" x 2.50"
(39.7 x 31.5 x 6.4 cm)

Cat. No. 1085 **WF**
† Designed to protect 14" laptops.



1095

INTERNAL DIMS:
15.78" x 11.16" x 2.06"
(40.1 x 28.3 x 5.2 cm)

EXTERNAL DIMS:
17.18" x 13.24" x 2.60"
(43.6 x 33.6 x 6.6 cm)

Cat. No. 1095 WF
† Designed to protect 15" laptops.



1470

INTERNAL DIMS:
15.70" x 10.70" x 3.87"
(39.9 x 27.2 x 9.8 cm)

EXTERNAL DIMS:
16.88" x 13.23" x 4.47"
(42.9 x 33.6 x 11.4 cm)

Cat. No. 1470 WF
Cat. No. 1470NF NF



1490

INTERNAL DIMS:
17.75" x 11.37" x 4.12"
(45.1 x 28.9 x 10.5 cm)

EXTERNAL DIMS:
19.87" x 13.93" x 4.68"
(50.5 x 35.4 x 11.9 cm)

Cat. No. 1490 WF
Cat. No. 1490NF NF



1490CC1

INTERNAL DIMS:
17.75" x 11.37" x 4.12"
(45.1 x 28.9 x 10.5 cm)

EXTERNAL DIMS:
19.87" x 13.93" x 4.68"
(50.4 x 35.4 x 11.9 cm)

Cat. No. 1490CC1
Case with lid organizer, fitted shock absorbing tray, and removable shoulder strap.



1495

INTERNAL DIMS:
18.87" x 13.12" x 3.81"
(47.9 x 33.3 x 9.7 cm)

EXTERNAL DIMS:
21.62" x 17.25" x 4.87"
(54.9 x 43.8 x 12.4 cm)

Cat. No. 1495 WF
Cat. No. 1495NF NF



1495CC1

INTERNAL DIMS:
18.87" x 13.12" x 3.81"
(47.9 x 33.3 x 9.7 cm)

EXTERNAL DIMS:
21.62" x 17.25" x 4.87"
(54.9 x 43.8 x 12.4 cm)

Cat. No. 1495CC1
Case with lid organizer, shock absorbing tray, nylon padded computer sleeve, accessories pouch, and removable shoulder strap.



1430 TOP LOADER

INTERNAL DIMS:
13.56" x 5.76" x 11.70"
(34.4 x 14.6 x 29.7 cm)

EXTERNAL DIMS:
16.40" x 8.71" x 13.15"
(41.7 x 22.1 x 33.4 cm)

Cat. No. 1430 WF
Cat. No. 1430NF NF
Cat. No. 1437
(with padded office divider and lid organizer)



1440 TOP LOADER

INTERNAL DIMS:
17.10" x 7.50" x 16.00"
(43.4 x 19.1 x 40.6 cm)

EXTERNAL DIMS:
19.70" x 12.00" x 18.00"
(50 x 30.5 x 45.7 cm)

Cat. No. 1440 WF
Cat. No. 1440NF NF
Cat. No. 1444
(with utility padded divider and lid organizer)
Cat. No. 1447
(with padded office divider and lid organizer)



MEDIUM CASES

Mobility with room for protecting larger gear or multiple instruments and accessories. Interior options are available for extra protection. Select models meet carry-on luggage specifications. Most cases are available empty, with foam, padded dividers or TrekPak™ dividers. See chart on page 31.



Icon indicates select models with wheels

1450

INTERNAL DIMS:
14.66" x 10.24" x 6.12"
(37.2 x 26 x 15.5 cm)

EXTERNAL DIMS:
16.44" x 13" x 6.82"
(41.8 x 33 x 17.3 cm)

Cat. No. 1450 WF
Cat. No. 1450NF NF
Cat. No. 1454 WD



1460

INTERNAL DIMS:
18.54" x 9.92" x 10.92"
(47.1 x 25.2 x 27.7cm)

EXTERNAL DIMS:
20.85" x 12.73" x 12.75"
(53 x 32.3 x 32.4 cm)

Cat. No. 1460 WF
Cat. No. 1460NF NF



1460 TOOL CASE

INTERNAL DIMS:
18.54" x 9.92" x 10.92"
(47.1 x 25.2 x 27.7cm)

EXTERNAL DIMS:
20.85" x 12.73" x 12.75"
(53 x 32.3 x 32.4 cm)

Cat. No. 1460TOOL
Case with adjustable and removable tray dividers for easy customization.



1460 EMS

INTERNAL DIMS:
18.54" x 9.92" x 10.92"
(47.1 x 25.2 x 27.7 cm)

EXTERNAL DIMS:
20.85" x 12.73" x 12.75"
(53 x 32.3 x 32.4 cm)

Cat. No. 1460EMS
Case with adjustable and removable tray dividers for EMS professionals.



1500

INTERNAL DIMS:
16.75" x 11.18" x 6.12"
(42.5 x 28.4 x 15.5 cm)

EXTERNAL DIMS:
18.50" x 14.06" x 6.93"
(47 x 35.7 x 17.6 cm)

Cat. No. 1500 WF
Cat. No. 1500NF NF
Cat. No. 1504 WD



DIMS: L x W x D

1500 EMS

INTERNAL DIMS:
16.75" x 11.18" x 6.12"
(42.5 x 28.4 x 15.5 cm)

EXTERNAL DIMS:
18.50" x 14.06" x 6.93"
(47 x 35.7 x 17.6 cm)

Cat. No. 1500EMS
Case with custom configured lid organizer and trays for EMS professionals.



1510 LOC

INTERNAL DIMS:
19.75" x 11.00" x 7.60"
(50.2 x 27.9 x 19.3 cm)

EXTERNAL DIMS:
22.00" x 13.81" x 9.00"
(55.9 x 35.1 x 22.9 cm)

Cat. No. 1510LOC
Case with fully enclosed apparel insert, padded laptop sleeve, and accessory pouch.



1520

INTERNAL DIMS:
18.06" x 12.89" x 6.72"
(45.9 x 32.7 x 17.1 cm)

EXTERNAL DIMS:
19.78" x 15.77" x 7.41"
(50.2 x 40.1 x 18.8 cm)

Cat. No. 1520 WF
Cat. No. 1520NF NF
Cat. No. 1524 WD



1510 WHEELED CARRY-ON

INTERNAL DIMS:
19.75" x 11.00" x 7.60"
(50.2 x 27.9 x 19.3 cm)

EXTERNAL DIMS:
22.00" x 13.81" x 9.00"
(55.9 x 35.1 x 22.9 cm)

Cat. No. 1510 WF
Cat. No. 1510NF NF
Cat. No. 1510TP TP
Cat. No. 1510TPF TPF
Cat. No. 1514 WD
Check with airline for exact measurement requirements.



AVAILABLE:
HYBRID INTERIOR
TREKPAK™ & PICK N PLUCK™

1510 SC

INTERNAL DIMS:
19.75" x 11.00" x 7.60"
(50.2 x 27.9 x 19.3 cm)

EXTERNAL DIMS:
22.00" x 13.81" x 9.00"
(55.9 x 35.1 x 22.9 cm)

Cat. No. 1510SC
Case with padded dividers, padded laptop sleeve, and accessory pouch.



1510M

INTERNAL DIMS:
19.75" x 11.00" x 7.60"
(50.2 x 27.9 x 19.3 cm)

EXTERNAL DIMS:
23.55" x 14.36" x 10.62"
(59.8 x 36.5 x 27 cm)

Cat. No. 1510M WF
Cat. No. 1510MNF NF
Mobility version features two oversized wheels for use on rough terrain.



1510 LFC

INTERNAL DIMS:
19.75" x 11.00" x 7.60"
(50.2 x 27.9 x 19.3 cm)

EXTERNAL DIMS:
22.00" x 13.81" x 9.00"
(55.9 x 35.1 x 22.9 cm)

Cat. No. 1510LFC
Case with Pick N Pluck™ foam, padded laptop sleeve, and accessory pouch.



1550 EMS

INTERNAL DIMS:
18.43" x 14.00" x 7.62"
(46.8 x 35.6 x 19.4 cm)

EXTERNAL DIMS:
20.62" x 16.87" x 8.12"
(52.4 x 42.8 x 20.6 cm)

Cat. No. 1550EMS
Case with custom configured lid organizer and trays for EMS professionals.



LARGE CASES

Designed for extreme protection during transport and storage. Customizable interiors allow for extra protection and inventory control. Select models feature retractable handles, extra wide grips and sturdy casters for efficient mobility.



Icon indicates select models with wheels



1560

INTERNAL DIMS:
19.92" x 14.98" x 9.00"
(50.6 x 38 x 22.9 cm)

EXTERNAL DIMS:
22.07" x 17.92" x 10.42"
(56.1 x 45.5 x 26.5 cm)

Cat. No. 1560 **WF**
Cat. No. 1560**NF** **NF**
Cat. No. 1560**TP** **TP**
Cat. No. 1564 **WD**



1560M

INTERNAL DIMS:
19.92" x 14.98" x 9.00"
(50.6 x 38 x 22.9 cm)

EXTERNAL DIMS:
23.78" x 18.33" x 12.08"
(60.4 x 46.6 x 30.7 cm)

Cat. No. 1560**M** **WF**
Cat. No. 1560**MNF** **NF**
Mobility version features two oversized wheels for use on rough terrain.



1560SC

INTERNAL DIMS:
19.92" x 14.98" x 9.00"
(50.6 x 38 x 22.9 cm)

EXTERNAL DIMS:
22.07" x 17.92" x 10.42"
(56.1 x 45.5 x 26.5 cm)

Cat. No. 1560**SC**
Case with padded dividers, padded laptop sleeve, and accessory pouch.



1560LFC

INTERNAL DIMS:
19.92" x 14.98" x 9.00"
(50.6 x 38 x 22.9 cm)

EXTERNAL DIMS:
22.07" x 17.92" x 10.42"
(56.1 x 45.5 x 26.5 cm)



1600

INTERNAL DIMS:
21.51" x 16.54" x 7.99"
(54.6 x 42 x 20.3 cm)

EXTERNAL DIMS:
24.39" x 19.36" x 8.79"
(62 x 49.2 x 22.3 cm)

Cat. No. 1600 **WF**
Cat. No. 1600**NF** **NF**
Cat. No. 1604 **WD**
Cat. No. 1600**TP** **TP**



1600 EMS

INTERNAL DIMS:
21.51" x 16.54" x 7.99"
(54.6 x 42 x 20.3 cm)

EXTERNAL DIMS:
24.39" x 19.36" x 8.79"
(62 x 49.2 x 22.3 cm)

Cat. No. 1600**EMS**
Case with custom configured lid organizer and trays for EMS professionals.



1610

INTERNAL DIMS:
21.78" x 16.69" x 10.62"
(55.3 x 42.4 x 27 cm)

EXTERNAL DIMS:
24.83" x 19.69" x 11.88"
(63.1 x 50 x 30.2 cm)

Cat. No. 1610 **WF**
Cat. No. 1610**NF** **NF**
Cat. No. 1614 **WD**
Cat. No. 1610**TP** **TP**



1610M

INTERNAL DIMS:
21.78" x 16.69" x 10.62"
(55.3 x 42.4 x 27 cm)

EXTERNAL DIMS:
26.20" x 23.00" x 13.68"
(66.5 x 58.4 x 34.7 cm)

Cat. No. 1610**M** **WF**
Cat. No. 1610**MNF** **NF**
Mobility version features two oversized wheels for use on rough terrain.



1620

INTERNAL DIMS:
21.48" x 16.42" x 12.54"
(54.6 x 41.7 x 31.9 cm)

EXTERNAL DIMS:
24.76" x 19.57" x 13.90"
(62.9 x 49.7 x 35.3 cm)

Cat. No. 1620 **WF**
Cat. No. 1620**NF** **NF**
Cat. No. 1624 **WD**



1620M

INTERNAL DIMS:
21.48" x 16.42" x 12.54"
(54.6 x 41.7 x 31.9 cm)

EXTERNAL DIMS:
26.20" x 23.00" x 15.61"
(66.5 x 58.4 x 39.6 cm)

Cat. No. 1620**M** **WF**
Cat. No. 1620**MNF** **NF**
Mobility version features two oversized wheels for use on rough terrain.



1630

INTERNAL DIMS:
27.70" x 20.98" x 15.50"
(70.4 x 53.3 x 39.4 cm)

EXTERNAL DIMS:
31.28" x 24.21" x 17.48"
(79.5 x 61.5 x 44.4 cm)

Cat. No. 1630 **WF**
Cat. No. 1630**NF** **NF**
Cat. No. 1634 **WD**



1780

INTERNAL DIMS:
41.12" x 21.54" x 14.88"
(104.4 x 54.7 x 37.8 cm)

EXTERNAL DIMS:
44.90" x 25.32" x 16.50"
(114 x 64.3 x 41.9 cm)

Cat. No. 1780 **WF**
Cat. No. 1780**NF** **NF**



0340

INTERNAL DIMS:
18.00" x 18.00" x 18.00"
(45.7 x 45.7 x 45.7 cm)

EXTERNAL DIMS:
20.50" x 20.50" x 19.25"
(52.1 x 52.1 x 48.9 cm)

Cat. No. 0340 **WF**
Cat. No. 0340**NF** **NF**



0350

INTERNAL DIMS:
20.00" x 20.00" x 20.00"
(50.8 x 50.8 x 50.8 cm)

EXTERNAL DIMS:
22.50" x 22.43" x 21.25"
(57.2 x 57 x 54 cm)

Cat. No. 0350 **WF**
Cat. No. 0350**NF** **NF**
Cat. No. 0354 **WD**



1640

INTERNAL DIMS:
23.70" x 24.00" x 13.90"
(60.2 x 61 x 35.3 cm)

EXTERNAL DIMS:
27.20" x 27.50" x 16.30"
(69.1 x 69.9 x 41.4 cm)

Cat. No. 1640 **WF**
Cat. No. 1640**NF** **NF**



1650

INTERNAL DIMS:
28.57" x 17.52" x 10.65"
(72.6 x 44.5 x 27.1 cm)

EXTERNAL DIMS:
31.59" x 20.47" x 12.45"
(80.2 x 52 x 31.6 cm)

Cat. No. 1650 **WF**
Cat. No. 1650**NF** **NF**
Cat. No. 1654 **WD**
Cat. No. 1650**TP** **TP**



1660

INTERNAL DIMS:
28.20" x 19.66" x 17.63"
(71.6 x 49.9 x 44.8 cm)

EXTERNAL DIMS:
31.59" x 22.99" x 19.48"
(80.2 x 58.4 x 49.5 cm)

Cat. No. 1660 **WF**
Cat. No. 1660**NF** **NF**
Cat. No. 1664 **WD**

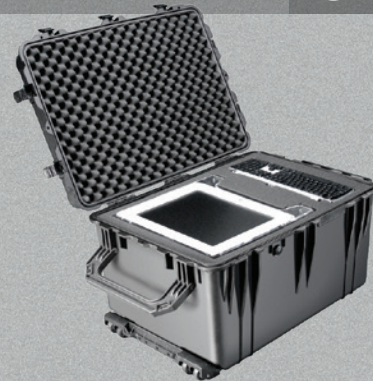

0370

INTERNAL DIMS:
24.00" x 24.00" x 24.00"
(61 x 61 x 61 cm)

EXTERNAL DIMS:
26.50" x 26.50" x 25.25"
(67.3 x 67.3 x 64.1 cm)

Cat. No. 0370 **WF**
Cat. No. 0370**NF** **NF**



0450

INTERNAL DIMS:
Varies by drawer configuration.

EXTERNAL DIMS:
23.95" x 14.75" x 17.95"
(60.8 x 37.5 x 45.6 cm)

Cat. No. 0450**SD4**
(4 shallow + 2 deep drawers)
Cat. No. 0450**SD6**
(6 shallow + 1 deep drawer)



1670

INTERNAL DIMS:
28.10" x 16.49" x 9.19"
(71.4 x 41.9 x 23.3 cm)

EXTERNAL DIMS:
31.04" x 19.39" x 11.17"
(78.8 x 49.3 x 28.4 cm)

Cat. No. 1670 **WF**
Cat. No. 1670**NF** **NF**



1690

INTERNAL DIMS:
30.13" x 25.13" x 15.36"
(76.5 x 63.8 x 39 cm)

EXTERNAL DIMS:
33.43" x 28.40" x 17.65"
(84.9 x 72.1 x 44.8 cm)

Cat. No. 1690 **WF**
Cat. No. 1690**NF** **NF**
Cat. No. 1694 **WD**



1730

INTERNAL DIMS:
34.00" x 24.00" x 12.50"
(86.4 x 61 x 31.8 cm)

EXTERNAL DIMS:
37.05" x 27.20" x 14.37"
(94.1 x 69.1 x 36.5 cm)

Cat. No. 1730 **WF**
Cat. No. 1730**NF** **NF**



0500

INTERNAL DIMS:
34.95" x 18.45" x 25.25"
(88.8 x 46.9 x 64.1 cm)

EXTERNAL DIMS:
39.95" x 23.45" x 28.65"
(101.5 x 59.6 x 72.8 cm)

Cat. No. 0500 **WF**
Cat. No. 0500**NF** **NF**



0550

INTERNAL DIMS:
47.57" x 24.07" x 17.68"
(120.8 x 61.1 x 44.9 cm)

EXTERNAL DIMS:
51.05" x 27.54" x 22.79"
(129.7 x 70 x 57.9 cm)

Cat. No. 0550 **WF**
Cat. No. 0550**NF** **NF**



SHOWN WITH OPTIONAL CASTER WHEELS



LONG CASES

Ideal for weapons, but are also used by industrial workers for instruments and gear. Equipped with sturdy polyurethane wheels for ease of transport. All Long Cases are available empty or with solid foam (not Pick N Pluck™ foam). See chart on page 35.



Icon indicates select models with wheels



DIMS: L x W x D

1700



INTERNAL DIMS:
35.75" x 13.50" x 5.25"
(90.8 x 34.3 x 13.3 cm)

EXTERNAL DIMS:
38.12" x 16.00" x 6.12"
(96.8 x 40.6 x 15.5 cm)

Cat. No. **1700** **WF**
Cat. No. **1700NF** **NF**



1720



INTERNAL DIMS:
42.00" x 13.50" x 5.25"
(106.7 x 34.3 x 13.3 cm)

EXTERNAL DIMS:
44.37" x 16.00" x 6.12"
(112.7 x 40.6 x 15.5 cm)

Cat. No. **1720** **WF**
Cat. No. **1720NF** **NF**



1740



INTERNAL DIMS:
40.98" x 12.92" x 12.13"
(104.1 x 32.8 x 30.8 cm)

EXTERNAL DIMS:
44.16" x 16.09" x 14.00"
(112.2 x 40.9 x 35.6 cm)

Cat. No. **1740** **WF**
Cat. No. **1740NF** **NF**



1750



INTERNAL DIMS:
50.50" x 13.50" x 5.25"
(128.2 x 34.3 x 13.3 cm)

EXTERNAL DIMS:
53.00" x 16.00" x 6.12"
(134.6 x 40.6 x 15.5 cm)

Cat. No. **1750** **WF**
Cat. No. **1750NF** **NF**



1770



INTERNAL DIMS:
54.58" x 15.58" x 8.63"
(138.6 x 39.6 x 21.9 cm)

EXTERNAL DIMS:
57.42" x 18.48" x 11.23"
(145.8 x 46.9 x 28.5 cm)

Cat. No. **1770** **WF**
Cat. No. **1770NF** **NF**

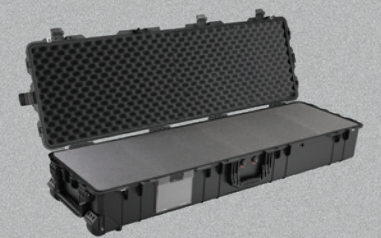

1780



INTERNAL DIMS:
41.12" x 21.54" x 14.88"
(104.4 x 54.7 x 37.8 cm)

EXTERNAL DIMS:
44.90" x 25.32" x 16.50"
(114 x 64.3 x 41.9 cm)

Cat. No. **1780** **WF**
Cat. No. **1780NF** **NF**
Cat. No. **1780HL**
(rifle hard liner insert)
Cat. No. **1780RF**
(rifle foam cut insert)





PELICAN™ STORM CASE™ SERIES

PROFESSIONAL-GRADE PROTECTION WITH EASY-TO-USE LATCHES

The Pelican™ Storm Case™ Series combines our ultra sleek, professional-grade design with easy-to-use, self locking, Press & Pull™ latches for protection and convenience.



PELICAN™ STORM CASE™ SERIES COLORS AVAILABLE

*Not available in all case sizes.



BLACK



YELLOW



OD GREEN



PRESS & PULL™ LATCHES

These smooth-opening, patented latches hold tight under pressure and impact with easy-opening performance. Tested to over 400 lbs., yet open with a simple release button.



MOLDED-IN LOCKABLE HASPS

Twin mating hasp holes on the rim of the case allow padlocks to keep your gear in and thieves out.



VORTEX® PRESSURE RELEASE VALVE

The automatic pressure release valve prevents vacuum lock, making it easy to open your case even after extreme altitude changes. The microscopic filter blocks water molecules and dust particles so your gear stays clean.



RUGGED IN-LINE WHEELS

Shielded from dust, dirt and other contaminants – ball bearing wheels provide low-friction, low-drag rolling for easy movement of heavy loads.

*Select models only.



DOUBLE-LAYER, SOFT-GRIP HANDLES

When the weather goes south you'll find a secure grip that won't slip. An in-tool vulcanizing process over-molds the grips to the polymer handle for a lifetime of dependable performance.

SMALL CASES

Perfect for small gear and instruments, with all the features found in our larger cases: strong HPX™ resin construction, Vortex™ valve, and Press & Pull™ latches.



iM2050

INTERNAL DIMS:
9.50" x 7.50" x 4.25"
(24.1 x 19.1 x 10.8 cm)

EXTERNAL DIMS:
11.80" x 9.80" x 4.70"
(30 x 24.9 x 11.9 cm)

Cat. No. **iM2050-X0001** **WF**
Cat. No. **iM2050-X0000** **NF**



iM2075

INTERNAL DIMS:
9.50" x 7.50" x 7.25"
(24.1 x 19.1 x 18.4 cm)

EXTERNAL DIMS:
11.80" x 9.80" x 7.70"
(30 x 24.9 x 19.6 cm)

Cat. No. **iM2075-X0001** **WF**
Cat. No. **iM2075-X0000** **NF**



iM2100

INTERNAL DIMS:
13.00" x 9.20" x 6.00"
(33 x 23.4 x 15.2 cm)

EXTERNAL DIMS:
14.20" x 11.40" x 6.50"
(36.1 x 29 x 16.5 cm)

Cat. No. **iM2100-X00010** **WF**
Cat. No. **iM2100-X0000** **NF**



MEDIUM CASES

From firefighters, EMTs, outdoor enthusiasts, and law enforcement, to industrial engineers and photographers, there's a Pelican™ Storm Case™ Series case for every professional. Built strong in two standard configurations: Pick N Pluck™ foam or empty.



Icon indicates select models with wheels

iM2200

INTERNAL DIMS:
15.00" x 10.50" x 6.00"
(38.1 x 26.7 x 15.2 cm)

EXTERNAL DIMS:
16.20" x 12.70" x 6.60"
(41.1 x 32.3 x 16.8cm)

Cat. No. **iM2200-X0001** **WF**
Cat. No. **iM2200-X0000** **NF**



iM2300

INTERNAL DIMS:
17.00" x 11.70" x 6.20"
(43.2 x 29.7 x 15.7cm)

EXTERNAL DIMS:
18.20" x 13.9" x 6.70"
(46.2 x 35.3 x 17cm)

Cat. No. **iM2300-X0001** **WF**
Cat. No. **iM2300-X0000** **NF**



iM2275

INTERNAL DIMS:
14.12" x 13.19" x 9.90"
(35.9 x 33.5 x 25.1 cm)

EXTERNAL DIMS:
15.25" x 15.50" x 10.22"
(38.7 x 39.4 x 26 cm)

Cat. No. **iM2275-X0001** **WF**
Cat. No. **iM2275-X0000** **NF**



iM2306

INTERNAL DIMS:
17.00" x 6.30" x 6.20"
(43.2 x 16 x 15.7cm)

EXTERNAL DIMS:
18.20" x 8.40" x 6.70"
(46.2 x 21.3 x 17cm)

Cat. No. **iM2306-X0001** **WF**
Cat. No. **iM2306-X0000** **NF**



iM2370 LAPTOP CASE

INTERNAL DIMS:
18.20" x 12.10" x 5.20"
(46.2 x 30.7 x 13.2 cm)

EXTERNAL DIMS:
20.00" x 14.70" x 5.80"
(50.8 x 37.3 x 14.7 cm)

Cat. No. **iM2370-X0001** **WF**
Cat. No. **iM2370-X0000** **NF**



iM2400

INTERNAL DIMS:
18.00" x 13.00" x 6.70"
(45.7 x 33 x 17 cm)

EXTERNAL DIMS:
19.20" x 15.20" x 7.30"
(48.8 x 38.6 x 18.5 cm)

Cat. No. **iM2400-X0001** WF
Cat. No. **iM2400-X0000** NF



iM2435

INTERNAL DIMS:
17.50" x 6.50" x 15.50"
(44.5 x 16.5 x 39.4 cm)

EXTERNAL DIMS:
18.63" x 9.25" x 16.50"
(47.3 x 23.5 x 41.9 cm)

Cat. No. **iM2435-X0001** WF
Cat. No. **iM2435-X0000** NF



iM2450

INTERNAL DIMS:
18.00" x 13.00" x 8.40"
(45.7 x 33 x 21.3 cm)

EXTERNAL DIMS:
19.20" x 15.20" x 9.00"
(48.8 x 38.6 x 22.9 cm)

Cat. No. **iM2450-X0001** WF
Cat. No. **iM2450-X0000** NF



iM2500

INTERNAL DIMS:
20.50" x 11.50" x 7.20"
(52.1 x 29.2 x 18.3 cm)

EXTERNAL DIMS:
21.70" x 14.10" x 8.90"
(55.1 x 35.8 x 22.6 cm)

Cat. No. **iM2500-X0001** WF
Cat. No. **iM2500-X0000** NF



iM2600

INTERNAL DIMS:
20.00" x 14.00" x 7.70"
(50.8 x 35.6 x 19.6 cm)

EXTERNAL DIMS:
21.20" x 16.00" x 8.30"
(53.8 x 40.6 x 21.1 cm)

Cat. No. **iM2600-X0001** WF
Cat. No. **iM2600-X0000** NF



iM2620

INTERNAL DIMS:
20.00" x 14.00" x 10.00"
(50.8 x 35.6 x 25.4 cm)

EXTERNAL DIMS:
21.20" x 16.00" x 10.60"
(53.8 x 40.6 x 26.9 cm)

Cat. No. **iM2620-X0001** WF
Cat. No. **iM2620-X0000** NF



LARGE CASES

In the lab or out in the field, a large Pelican™ Storm Case™ Series case with HPX™ resin construction stores and protects valuable and sensitive equipment from the elements. Pick N Pluck™ foam adds extra protection from shock during transport.



Icon indicates select models with wheels

iM2700

INTERNAL DIMS:
22.00" x 17.00" x 8.00"
(55.9 x 43.2 x 20.3 cm)

EXTERNAL DIMS:
24.60" x 19.70" x 8.60"
(62.5 x 50 x 21.8 cm)

Cat. No. **iM2700-X0001** WF
Cat. No. **iM2700-X0000** NF



iM2720

INTERNAL DIMS:
22.00" x 17.00" x 10.00"
(55.9 x 43.2 x 25.4 cm)

EXTERNAL DIMS:
24.60" x 19.70" x 11.70"
(62.5 x 50 x 29.7 cm)

Cat. No. **iM2720-X0001** WF
Cat. No. **iM2720-X0000** NF



iM2750

INTERNAL DIMS:
22.00" x 17.00" x 12.70"
(55.9 x 43.2 x 32.2 cm)

EXTERNAL DIMS:
24.60" x 19.70" x 14.40"
(62.5 x 50 x 36.6 cm)

Cat. No. **iM2750-X0001** WF
Cat. No. **iM2750-X0000** NF



iM2875

INTERNAL DIMS:
22.50" x 21.10" x 11.40"
(57.2 x 53.6 x 29 cm)

EXTERNAL DIMS:
24.90" x 23.70" x 13.10"
(63.2 x 60.2 x 33.3 cm)

Cat. No. **iM2870-X0001** WF
Cat. No. **iM2870-X0000** NF



iM2950

INTERNAL DIMS:
29.00" x 18.00" x 10.50"
(73.7 x 45.7 x 26.7 cm)

EXTERNAL DIMS:
31.30" x 20.40" x 12.20"
(79.5 x 51.8 x 31 cm)

Cat. No. **iM2950-X0001** WF
Cat. No. **iM2950-X0000** NF



iM2975



INTERNAL DIMS:
29.00" x 18.00" x 13.80"
(73.7 x 45.7 x 35.1 cm)

EXTERNAL DIMS:
31.30" x 20.40" x 15.50"
(79.5 x 51.8 x 39.4 cm)

Cat. No. **iM2975-X0001** **WF**
Cat. No. **iM2975-X0000** **NF**



iM3075



INTERNAL DIMS:
29.80" x 20.80" x 17.80"
(75.7 x 52.8 x 45.2 cm)

EXTERNAL DIMS:
33.30" x 24.40" x 19.30"
(84.6 x 62 x 49 cm)

Cat. No. **iM3075-X0001** **WF**
Cat. No. **iM3075-X0000** **NF**



iM3100



INTERNAL DIMS:
36.50" x 14.00" x 6.00"
(92.7 x 35.6 x 15.2 cm)

EXTERNAL DIMS:
39.80" x 16.50" x 6.70"
(101.1 x 41.9 x 17 cm)

Cat. No. **iM3100-X0001** **WF**
Cat. No. **iM3100-X0000** **NF**



iM3200



INTERNAL DIMS:
44.00" x 14.00" x 6.00"
(111.8 x 35.6 x 15.2 cm)

EXTERNAL DIMS:
47.20" x 16.50" x 6.70"
(119.9 x 41.9 x 17 cm)

Cat. No. **iM3200-X0001** **WF**
Cat. No. **iM3200-X0000** **NF**



iM3220



INTERNAL DIMS:
44.00" x 14.00" x 8.50"
(111.8 x 35.6 x 21.6 cm)

EXTERNAL DIMS:
47.20" x 16.50" x 9.20"
(119.9 x 41.9 x 23.4 cm)

Cat. No. **iM3220-X0001** **WF**
Cat. No. **iM3220-X0000** **NF**



iM3300



INTERNAL DIMS:
50.50" x 14.00" x 6.00"
(128.3 x 35.6 x 15.2 cm)

EXTERNAL DIMS:
53.80" x 16.50" x 6.70"
(136.7 x 41.9 x 17 cm)

Cat. No. **iM3300-X0001** **WF**
Cat. No. **iM3300-X0000** **NF**

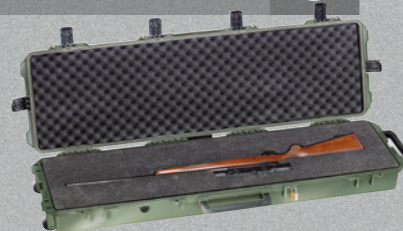

iM3410



INTERNAL DIMS:
54.50" x 10.00" x 6.00"
(138.4 x 25.4 x 15.2 cm)

EXTERNAL DIMS:
57.74" x 12.71" x 6.67"
(146.7 x 32.3 x 16.9 cm)

Cat. No. **iM3410-X0001** **WF**
Cat. No. **iM3410-X0000** **NF**



C = Configuration and/or Accessory Kit Available (on black and select colors)
 S = Standard feature
 O = Optional accessory only

	CAT. NO.	INTERIOR DIMENSIONS		EXTERIOR DIMENSIONS		RUBBERIZED HANDLES	WHEELS & TROLLEY HANDLE	PERSONALIZED NAMEPLATES	BUSINESS CARD HOLDER	PADDED DIVIDERS	TREKPAK™ KIT	LID ORGANIZERS	PANEL FRAMES
		inches	centimeters	inches	centimeters								
AIR CASES	1465 AIR	18.62 x 9.99 x 10.93	(47.3 x 25.4 x 27.8)	20.83 x 12.62 x 12.75	(52.9 x 32.1 x 32.4)	S							
	1465 EMS	18.62 x 9.99 x 10.93	(47.3 x 25.4 x 27.8)	20.83 x 12.62 x 12.75	(52.9 x 32.1 x 32.4)	S							
	1485 AIR	17.75 x 10.18 x 6.15	(45.1 x 25.9 x 15.6)	19.17 x 12.80 x 6.89	(48.7 x 32.5 x 17.5)	S		S			C		
	1506 AIR	18.70 x 9.40 x 7.80	(47.5 x 23.9 x 19.8)	20.12 x 12.02 x 8.56	(51.1 x 30.5 x 21.7)	S		S			C		
	1507 AIR	15.15 x 11.38 x 8.52	(38.5 x 28.9 x 21.6)	16.87 x 14.10 x 9.27	(42.8 x 35.8 x 23.5)	S		S		C	C		
	1525 AIR	20.50 x 11.30 x 6.75	(52.1 x 28.7 x 17.1)	21.96 x 13.97 x 7.49	(55.8 x 35.5 x 19)	S		S		C	C		
	1535 AIR	20.39 x 11.20 x 7.20	(51.8 x 28.4 x 18.3)	21.96 x 13.97 x 8.98	(55.8 x 35.5 x 22.8)	S	S		S	C	C	C	
	1555 AIR	23.00 x 12.75 x 7.50	(58.4 x 32.4 x 19.1)	24.76 x 15.46 x 8.24	(62.9 x 39.3 x 20.9)	S		S		C	C		
	1556 AIR	21.63 x 10.76 x 8.97	(54.9 x 27.3 x 22.8)	23.43 x 13.52 x 10.57	(59.5 x 34.3 x 26.8)	S	S		S				
	1557 AIR	17.33 x 13.00 x 9.75	(44.0 x 33.0 x 24.8)	19.18 x 15.79 x 10.50	(48.7 x 40.1 x 26.7)	S		S		C	C		
	1605 AIR	26.00 x 14.00 x 8.38	(66 x 35.6 x 21.3)	28.87 x 16.77 x 9.12	(73.3 x 42.6 x 23.2)	S		S		C	C		
	1606 AIR	24.54 x 12.30 x 10.22	(62.3 x 31.2 x 26)	27.42 x 15.13 x 11.83	(69.6 x 38.4 x 30)	S	S		S				
	1607 AIR	21.05 x 15.81 x 11.63	(53.5 x 40.2 x 29.5)	24.13 x 18.80 x 13.25	(61.3 x 47.8 x 33.7)	S	S		S		C		
	1615 AIR	29.59 x 15.50 x 9.38	(75.2 x 39.4 x 23.8)	32.58 x 18.40 x 11.02	(82.8 x 46.7 x 28)	S	S		S		C	C	C
	1626 AIR	28.14 x 14.10 x 11.72	(71.5 x 35.8 x 29.8)	31.12 x 17.05 x 13.33	(79 x 43.3 x 33.9)	S	S		S		C		
	1637 AIR	23.43 x 17.55 x 13.25	(59.5 x 44.6 x 33.7)	26.61 x 20.65 x 14.87	(67.6 x 52.5 x 37.8)	S	S		S		C		
	1646 AIR	32.06 x 15.87 x 13.42	(81.4 x 40.3 x 34.1)	35.29 x 19.00 x 15.08	(89.6 x 48.3 x 38.3)	S	S		S				
1745 AIR	44.01 x 16.77 x 7.94	(111.8 x 42.6 x 20.2)	46.69 x 19.36 x 8.73	(118.6 x 49.2 x 22.2)	S	S		S					
PERSONAL UTILITY CASES	GO 40	7.00 x 3.50 x 1.60	(17.8 x 8.9 x 4.1)	9.45 x 5.06 x 2.05	(24 x 12.9 x 5.2)								
	RUCK 20	7.07 x 3.39 x 1.95	(18 x 8.6 x 5)	8.96 x 4.83 x 2.88	(22.8 x 12.3 x 7.3)								
	RUCK 40	7.63 x 4.70 x 1.90	(19.4 x 11.9 x 4.8)	9.84 x 6.12 x 2.89	(25 x 15.5 x 7.3)								
	RUCK 60	8.90 x 5.37 x 2.96	(22.6 x 13.6 x 7.5)	11.14 x 6.86 x 3.88	(28.3 x 17.4 x 9.9)								
MC/SWC	0915/0945 0955/0965	4.79 x 2.25 x 0.55	(1.1 x 6.5 x 10.4 cm)	5.55 x 3.27 x 0.85	(14.1 x 8.3 x 2.2)								
	G5 RF	4.3 x 2.56 x 4.1	(11.1 x 7.3 x 4.3)	5.88 x 4.06 x 2.12	(14.9 x 10.3 x 5.4)								
MICRO CASE SERIES™	1010	4.37 x 2.87 x 1.68	(11.1 x 7.3 x 4.3)	5.88 x 4.06 x 2.12	(14.9 x 10.3 x 5.4)								
	1015	5.14 x 2.64 x 1.37	(13.1 x 6.7 x 3.5)	6.68 x 3.88 x 1.86	(17 x 9.9 x 4.7)								
	1020	5.31 x 3.56 x 1.68	(13.5 x 9 x 4.3)	6.82 x 4.75 x 2.12	(17.3 x 12.1 x 5.4)								
	1030	6.37 x 2.62 x 2.06	(16.2 x 6.7 x 5.2)	7.50 x 3.87 x 2.43	(19 x 9.8 x 6.2)								
	1040	6.50 x 3.87 x 1.75	(16.5 x 9.8 x 4.4)	7.50 x 5.06 x 2.12	(19 x 12.9 x 5.4)								
	1050	6.31 x 3.68 x 2.75	(16 x 9.3 x 7)	7.50 x 5.06 x 3.12	(19 x 12.9 x 7.9)								
	1060	8.25 x 4.25 x 2.25	(20.9 x 10.8 x 5.7)	9.37 x 5.56 x 2.62	(23.8 x 14.1 x 6.7)								
PROTECTOR™ SMALL CASES	1120	7.29 x 4.78 x 3.33	(18.5 x 12.2 x 8.5)	8.41 x 6.76 x 3.87	(21.4 x 17.2 x 9.8)						O	O	
	1150	8.29 x 5.79 x 3.75	(21.1 x 14.7 x 9.5)	9.44 x 7.80 x 4.29	(24 x 19.8 x 10.9)						O	O	
	1170	10.54 x 6.04 x 3.16	(26.8 x 15.3 x 8)	11.64 x 8.34 x 3.78	(29.6 x 21.2 x 9.6)						O	O	
	1200	9.25 x 7.12 x 4.12	(23.5 x 18.1 x 10.5)	10.62 x 9.68 x 4.87	(27 x 24.6 x 12.4)						O	O	
	1300	9.17 x 7.00 x 6.12	(23.3 x 17.8 x 15.5)	10.62 x 9.68 x 6.87	(27 x 24.6 x 17.4)						O	O	
	1400	11.81 x 8.87 x 5.18	(30 x 22.5 x 13.2)	13.37 x 11.62 x 6.00	(33.9 x 29.5 x 15.2)	S	O				O	O	
	1450	14.66 x 10.24 x 6.12	(37.2 x 26 x 15.5)	16.54 x 13.03 x 6.84	(42 x 33.1 x 17.4)	S	O			C	O	O	O
PROTECTOR™ MEDIUM CASES	1460	18.54 x 9.92 x 10.92	(47.1 x 25.2 x 27.7)	20.85 x 12.73 x 12.75	(52.9 x 32.3 x 32.4)	S						O	
	1500	16.75 x 11.18 x 6.12	(42.5 x 28.4 x 15.5)	18.50 x 14.06 x 6.93	(47 x 35.7 x 17.6)	S	O		C	O	C	O	
	1500 EMS	16.75 x 11.18 x 6.12	(42.5 x 28.4 x 15.5)	18.50 x 14.06 x 6.93	(47 x 35.7 x 17.6)	S	O		C	O	C	O	
	1510	19.75 x 11.00 x 7.60	(50.1 x 27.9 x 19.3)	22.00 x 13.81 x 9.00	(55.9 x 35.1 x 22.9)	S	S		C	C	C		
	1520	18.06 x 12.89 x 6.72	(45.9 x 32.7 x 17.1)	19.78 x 15.77 x 7.41	(50.2 x 40 x 18.8)	S	O		C	O	O	O	
	1550	18.43 x 14.00 x 7.62	(46.8 x 35.5 x 19.3)	20.62 x 16.87 x 8.12	(52.4 x 42.8 x 20.6)	S	O		C	O	C	O	
	1550 EMS	18.43 x 14.00 x 7.62	(46.8 x 35.5 x 19.3)	20.62 x 16.87 x 8.12	(52.4 x 42.8 x 20.6)	S	O		C	O	C	O	
DIGITAL PROTECTION CASES	1075	11.11 x 7.92 x 1.63	(28.2 x 20.1 x 4.1)	12.38 x 9.75 x 2.13	(31.4 x 24.8 x 5.4)								
	P1075	11.11 x 7.92 x 1.63	(28.2 x 20.1 x 4.1)	12.38 x 9.75 x 2.13	(31.4 x 24.8 x 5.4)								
	1085	14.29 x 10.37 x 1.97	(36.3 x 26.3 x 5)	15.64 x 12.41 x 2.50	(39.7 x 31.5 x 6.3)								
	1095	15.78 x 11.16 x 2.06	(40.1 x 28.3 x 5.2)	17.18 x 13.24 x 2.60	(43.6 x 33.6 x 6.6)								
	1095CC	15.78 x 11.16 x 2.06	(40.1 x 28.3 x 5.2)	17.18 x 13.24 x 2.60	(43.6 x 33.6 x 6.6)								
	1470	15.70 x 10.70 x 3.87	(39.9 x 27.2 x 9.8)	16.88 x 13.23 x 4.47	(42.9 x 33.6 x 11.3)	S	O						
	1490	17.75 x 11.37 x 4.12	(45.1 x 28.9 x 10.5)	19.87 x 13.93 x 4.68	(50.4 x 35.4 x 11.9)	S	O					O	
	1490CC1	17.75 x 11.37 x 4.12	(45.1 x 28.9 x 10.5)	19.87 x 13.93 x 4.68	(50.4 x 35.4 x 11.9)	S	O					S	
	1495	18.87 x 13.12 x 3.81	(47.9 x 33.3 x 9.7)	21.62 x 17.25 x 4.87	(54.9 x 43.8 x 12.4)	S	O						
	1495CC1	18.87 x 13.12 x 3.81	(47.9 x 33.3 x 9.7)	21.62 x 17.25 x 4.87	(54.9 x 43.8 x 12.4)	S	O					S	
	1430	13.56 x 5.76 x 11.70	(34.4 x 14.6 x 29.7)	16.40 x 8.71 x 13.15	(41.6 x 22.1 x 33.4)	S	O		C		C	O	
	1440	17.10 x 7.50 x 16.00	(43.4 x 19 x 40.6)	19.70 x 12.00 x 18.00	(50 x 30.5 x 45.7)	S	S	O		C		C	

C = Configuration and/or Accessory Kit Available (on black and select colors)
 S = Standard feature
 O = Optional accessory only

	CAT. NO.	INTERIOR DIMENSIONS		EXTERIOR DIMENSIONS		RUBBERIZED HANDLES	WHEELS & TROLLEY HANDLE	PERSONALIZED NAMEPLATES	BUSINESS CARD HOLDER	PADDED DIVIDERS	TREKPAK™ KIT	LID ORGANIZERS	PANEL FRAMES	
		inches	centimeters	inches	centimeters									
PROTECTOR™ LARGE CASES	1560	19.92 x 14.98 x 9.00	(50.6 x 38 x 22.9)	22.07 x 17.92 x 10.42	(56 x 45.5 x 26.5)	S	S	O		C	C	C		
	1600	21.51 x 16.54 x 7.99	(54.6 x 42 x 20.3)	24.39 x 19.36 x 8.79	(61.9 x 49.2 x 22.3)	S		O		C	C	O		
	1600 EMS	21.51 x 16.54 x 7.99	(54.6 x 42 x 20.3)	24.39 x 19.36 x 8.79	(61.9 x 49.2 x 22.3)	S		O		C	C	C		
	1610	21.78 x 16.69 x 10.62	(55.3 x 42.4 x 27)	24.83 x 19.69 x 11.88	(63 x 50 x 30.2)	S	S	O		C	C	O		
	1620	21.48 x 16.42 x 12.54	(54.5 x 41.7 x 31.8)	24.76 x 19.57 x 13.90	(62.9 x 49.7 x 35.3)	S	S	O		C		O		
	1630	27.70 x 20.98 x 15.50	(70.3 x 53.3 x 39.4)	31.28 x 24.21 x 17.48	(79.4 x 61.5 x 44.4)			O		C		O		
	1640	23.70 x 24.00 x 13.90	(60.2 x 60.9 x 35.3)	27.20 x 27.50 x 16.30	(69.1 x 69.8 x 41.4)			O						
	1650	28.57 x 17.52 x 10.62	(72.5 x 44.5 x 27)	31.59 x 20.47 x 12.45	(80.2 x 52 x 31.6)			O		C	C	O		
	1660	28.20 x 19.66 x 17.63	(71.6 x 49.9 x 44.8)	31.59 x 22.99 x 19.48	(80.2 x 58.4 x 49.5)			O		C		O		
	1670	28.10 x 16.49 x 9.19	(71.3 x 41.9 x 23.3)	31.04 x 19.39 x 11.17	(78.8 x 49.2 x 28.4)			O						
	1690	30.13 x 25.13 x 15.36	(76.5 x 63.8 x 39)	33.43 x 28.40 x 17.65	(84.9 x 72.1 x 44.8)			O				O		
	1730	34.00 x 24.00 x 12.50	(86.3 x 60.9 x 31.7)	37.50 x 27.13 x 14.37	(95.2 x 68.9 x 36.5)			O						
	1780	41.12 x 21.54 x 14.88	(104.4 x 54.7 x 37.8)	44.90 x 25.32 x 16.50	(114 x 64.3 x 41.9)			O						
	0340	18.00 x 18.00 x 18.00	(45.7 x 45.7 x 45.7)	20.50 x 20.50 x 19.25	(52 x 52 x 48.9)			O						
	0350	20.00 x 20.00 x 20.00	(50.8 x 50.8 x 50.8)	22.50 x 22.43 x 21.25	(57.1 x 56.9 x 54)			O						
	0370	24.00 x 24.00 x 24.00	(60.9 x 60.9 x 60.9)	26.50 x 26.50 x 25.25	(67.3 x 67.3 x 64.1)			O		O		O		
	0450	Varies by drawer configuration		23.95 x 14.75 x 17.95	(60.8 x 37.5 x 45.6)			O						
	0500	34.95 x 18.45 x 25.25	(88.7 x 46.8 x 64.1)	39.95 x 23.45 x 28.65	(101.4 x 59.5 x 72.7)			O						
	0550	47.57 x 24.07 x 17.68	(120.8 x 61.1 x 44.9)	51.05 x 27.54 x 22.79	(129.6 x 69.9 x 57.9)			O						
	PROTECTOR™ LONG CASES	1700	35.75 x 13.50 x 5.25	(90.8 x 34.3 x 13.3)	38.12 x 16.00 x 6.12	(96.8 x 40.6 x 15.5)								
		1720	42.00 x 13.50 x 5.25	(106.6 x 34.3 x 13.3)	44.37 x 16.00 x 6.12	(112.7 x 40.6 x 15.5)								
		1740	40.98 x 12.92 x 12.13	(104 x 32.8 x 30.8)	44.16 x 16.09 x 14.00	(112.1 x 40.9 x 35.5)								
		1750	50.50 x 13.50 x 5.25	(128.2 x 34.3 x 13.3)	53.00 x 16.00 x 6.12	(134.6 x 40.6 x 15.5)								
		1770	54.58 x 15.58 x 8.63	(138.6 x 39.6 x 21.9)	57.42 x 18.48 x 11.23	(145.8 x 46.9 x 28.5)								
1780		41.12 x 21.54 x 14.88	(104.4 x 54.7 x 37.8)	44.90 x 25.32 x 16.50	(114 x 64.3 x 41.9)									
iM2050-X0001		9.50" x 7.50" x 4.25"	(24.1 x 19.1 x 10.8)	11.80" x 9.80" x 7.70"	(30 x 24.9 x 19.6)								O	
iM2075-X0001	9.50" x 7.50" x 7.25"	(24.1 x 19.1 x 18.4)	11.80" x 9.80" x 7.70"	(30 x 24.9 x 19.6)									O	
iM2100-X0001	13.00" x 9.20" x 6.00"	(33 x 23.4 x 15.2)	14.20" x 11.40" x 6.50"	(36.1 x 29 x 16.5)							O		O	
iM2200-X0001	15.00" x 10.50" x 6.0													

CASE INTERIOR SIZE COMPARISON

Interior size comparison chart features the smallest case size [top] to largest case size [bottom], based on interior volume size.

PELICAN™ PROTECTOR CASE™ SERIES
 PELICAN™ AIR CASE SERIES
 PELICAN™ STORM CASE™ SERIES

CAT. NO.	INTERIOR DIMENSIONS		WEIGHT	
	inches	centimeters	lbs	kg
1120 PROTECTOR	7.29" x 4.78" x 3.33"	(18.5 x 12.1 x 8.5)	1.34	0.608
1150 PROTECTOR	8.29" x 5.79" x 3.75"	(21.1 x 14.7 x 9.5)	1.61	0.730
1170 PROTECTOR	10.54" x 6.04" x 3.16"	(26.8 x 15.3 x 8)	1.96	0.889
1200 PROTECTOR	9.25" x 7.12" x 4.12"	(23.5 x 18.1 x 10.5)	2.65	1.202
iM2050 STORM	9.5" x 7.5" x 4.25"	(24.1 x 19.1 x 10.8)	2.7	1.225
1300 PROTECTOR	9.17" x 7" x 6.12"	(23.3 x 17.8 x 15.5)	3.09	1.402
iM2075 STORM	9.5" x 7.5" x 7.25"	(24.1 x 19.1 x 18.4)	3.3	1.497
1400 PROTECTOR	11.81" x 8.87" x 5.18"	(30 x 22.5 x 13.2)	3.97	1.801
1470 PROTECTOR	15.7" x 10.7" x 3.87"	(39.9 x 27.2 x 9.8)	4.28	1.941
iM2306 STORM	17" x 6.3" x 6.2"	(43.2 x 16 x 15.7)	4.3	1.950
iM2100 STORM	13" x 9.2" x 6"	(33 x 23.4 x 15.2)	4.2	1.905
1490 PROTECTOR	17.75" x 11.37" x 4.12"	(45.1 x 28.9 x 10.5)	5.47	2.481
1450 PROTECTOR	14.66" x 10.24" x 6.12"	(37.2 x 26 x 15.5)	5.51	2.499
1495 PROTECTOR	18.87" x 13.12" x 3.81"	(47.9 x 33.3 x 9.7)	7.23	3.279
iM2200 STORM	15" x 10.5" x 6"	(38.1 x 26.7 x 15.2)	4.9	2.223
1485 AIR	17.75" x 10.18" x 6.15"	(45.1 x 25.9 x 15.6)	4.57	2.073
iM2370 STORM	18.2" x 12.1" x 5.2"	(46.2 x 30.7 x 13.2)	5.7	2.585
1500 PROTECTOR	16.75" x 11.18" x 6.12"	(42.5 x 28.4 x 15.5)	7.13	3.234
iM2300 STORM	17" x 11.7" x 6.2"	(43.2 x 29.7 x 15.7)	5.9	2.676
1506 AIR	18.70" x 9.40" x 7.80"	(47.5 x 23.9 x 19.8)	5.35	2.426
1507 AIR	15.15" x 11.38" x 8.52"	(38.5 x 28.9 x 21.6)	5.24	2.377
1520 PROTECTOR	18.06" x 12.89" x 6.72"	(45.9 x 32.7 x 17.1)	8.29	3.760
1525 AIR	20.5" x 11.31" x 6.75"	(52.1 x 28.7 x 17.1)	5.99	2.717
iM2400 STORM	18" x 13" x 6.7"	(45.7 x 33 x 17)	6.5	2.948
1535 AIR	20.39" x 11.2" x 7.21"	(51.8 x 28.4 x 18.3)	8.69	3.942
1510 PROTECTOR	19.75" x 11" x 7.6"	(50.2 x 27.9 x 19.3)	11.99	5.439
iM2500 STORM	20.5" x 11.5" x 7.2"	(52.1 x 29.2 x 18.3)	11.1	5.035
iM2435 STORM	17.5" x 6.5" x 15.5"	(44.5 x 16.5 x 39.4)	10	4.536
iM2275 STORM	14.12" x 13.19" x 9.9"	(35.9 x 33.5 x 25.1)	8	3.629
iM2450 STORM	18" x 13" x 8.4"	(45.7 x 33 x 21.3)	7.4	3.357
1460 PROTECTOR	18.54" x 9.92" x 10.92"	(47.1 x 25.2 x 27.7)	8.75	3.969
1465 AIR / 1465 EMS	18.62" x 9.99" x 10.93"	(47.3 x 25.4 x 27.8)	7.12	3.230
1550 PROTECTOR	18.63" x 14.18" x 7.72"	(47.3 x 36 x 19.6)	10.58	4.799
iM2600 STORM	20" x 14" x 7.7"	(50.8 x 35.6 x 19.6)	8.5	3.856
1557 AIR	17.33" x 13" x 9.75"	(44 x 33 x 24.8)	6.6	2.994
1556 AIR	21.63" x 10.76" x 8.97"	(54.9 x 27.3 x 22.8)	9.75	4.422
1555 AIR	23" x 12.75" x 7.5"	(58.4 x 32.4 x 19.1)	7.37	3.343
1700 PROTECTOR	35.75" x 13.5" x 5.25"	(90.8 x 34.3 x 13.3)	16.09	7.298

CAT. NO.	INTERIOR DIMENSIONS		WEIGHT	
	inches	centimeters	lbs	kg
1560 PROTECTOR	19.92" x 14.98" x 9"	(50.6 x 38 x 22.9)	17	7.711
0340 PROTECTOR	18" x 18" x 18"	(45.7 x 45.7 x 45.7)	24	10.886
iM2620 STORM	20" x 14" x 10"	(50.8 x 35.6 x 25.4)	12.5	5.670
1607 AIR	21.05" x 15.81" x 11.63"	(53.5 x 40.2 x 29.5)	13.20	5.987
1600 PROTECTOR	21.51" x 16.54" x 7.99"	(54.6 x 42 x 20.3)	13	5.897
0450 PROTECTOR	20.56" x 10.97" x 12.65"	(52.2 x 27.9 x 32.1)	41.50	18.8
1720 PROTECTOR	42" x 13.5" x 5.25"	(106.7 x 34.3 x 13.3)	16.76	7.602
iM2700 STORM	22" x 17" x 8"	(55.9 x 43.2 x 20.3)	11.1	5.035
1605 AIR	26" x 14" x 8.38"	(66 x 35.6 x 21.3)	9.28	4.209
iM3100 STORM	36.5" x 14" x 6"	(92.7 x 35.6 x 15.2)	15.2	6.895
iM3410 STORM	54.5" x 10" x 6"	(138.4 x 25.4 x 15.2)	18	8.165
1750 PROTECTOR	50.5" x 13.5" x 5.25"	(128.3 x 34.3 x 13.3)	23.59	10.700
iM3200 STORM	44" x 14" x 6"	(111.8 x 35.6 x 15.2)	17.7	8.029
iM2720 STORM	22" x 17" x 10"	(55.9 x 43.2 x 25.4)	16.8	7.620
1610 PROTECTOR	21.78" x 16.69" x 10.62"	(55.3 x 42.4 x 27)	19.5	8.845
1606 AIR	24.54" x 12.30" x 10.22"	(62.3 x 31.2 x 26)	12.45	5.6
iM3300 STORM	50.5" x 14" x 6"	(128.3 x 35.6 x 15.2)	19.1	8.664
1670 PROTECTOR	28.1" x 16.49" x 9.19"	(71.4 x 41.9 x 23.3)	23	10.433
1615 AIR	29.59" x 15.5" x 9.38"	(75.2 x 39.4 x 23.8)	14.06	6.378
1620 PROTECTOR	21.48" x 16.42" x 12.54"	(54.6 x 41.7 x 31.9)	21.20	9.6
iM2750 STORM	22" x 17" x 12.7"	(55.9 x 43.2 x 32.3)	18.5	8.391
iM3220 STORM	44" x 14" x 8.5"	(111.8 x 35.6 x 21.6)	20.4	9.253
1650 PROTECTOR	28.57" x 17.52" x 10.65"	(72.6 x 44.5 x 27.1)	24.03	10.900
iM2875 STORM	22.5" x 21.1" x 11.4"	(57.2 x 53.6 x 29)	20.1	9.117
1637 AIR	23.43" x 17.55" x 13.25"	(59.5 x 44.6 x 33.7)	15.2	6.895
1626 AIR	28.14" x 14.10" x 11.72"	(71.5 x 35.8 x 29.8)	14.65	6.645
iM2950 STORM	29" x 18" x 10.5"	(73.7 x 45.7 x 26.7)	20.8	9.435
0340 PROTECTOR	18.00" x 18.00" x 18.00"	(45.7 x 45.7 x 45.7)	24	10.9
1646 AIR	32.06" x 15.87" x 13.42"	(81.4 x 40.3 x 34.1)	20.50	9.298
1745 AIR	44" x 16.77" x 8"	(111.8 x 42.6 x 20.3)	17.26	7.829
1740 PROTECTOR	40.98" x 12.92" x 12.13"	(104.1 x 32.8 x 30.8)	22	9.979
iM2975 STORM	29" x 18" x 13.8"	(73.7 x 45.7 x 35.1)	22.8	10.342
1770 PROTECTOR	54.58" x 15.58" x 8.63"	(138.6 x 39.6 x 21.9)	29	13.154
1640 PROTECTOR	23.7" x 24" x 13.9"	(60.2 x 61 x 35.3)	34	15.422
0350 PROTECTOR	20" x 20" x 20"	(50.8 x 50.8 x 50.8)	25.99	11.789
1630 PROTECTOR	27.7" x 20.98" x 15.5"	(70.4 x 53.3 x 39.4)	31	14.061
1660 PROTECTOR	28.2" x 19.66" x 17.63"	(71.6 x 49.9 x 44.8)	34.16	15.495
1730 PROTECTOR	34" x 24" x 12.5"	(86.4 x 61 x 31.8)	30	13.608
iM3075 STORM	29.8" x 20.8" x 17.8"	(75.7 x 52.8 x 45.2)	31.5	14.288
1690 PROTECTOR	30.13" x 25.13" x 15.36"	(76.5 x 63.8 x 39)	34	15.422
1780 PROTECTOR	41.12" x 21.54" x 14.88"	(104.4 x 54.7 x 37.8)	38.4	17.418
0370 PROTECTOR	24" x 24" x 24"	(61 x 61 x 61)	31.97	14.501
0500 PROTECTOR	34.95" x 18.45" x 25.25"	(88.8 x 46.9 x 64.1)	50	22.680
0550 PROTECTOR	47.57" x 24.07" x 17.68"	(120.8 x 61.1 x 44.9)	79.2	35.925



SERVICES & ACCESSORIES



SHOULDER STRAP
Heavy-duty shoulder strap offers comfort and support.

THINK INSIDE AND OUTSIDE THE BOX

The exterior protection of your hard case is only half the story and, with interior customization and accessory options, you get 360° of protection and organization solutions.

Inside the Box interior case solutions offer you multiple organization options. Choose from our TrekPak™ divider system, padded dividers, or Pick N Pluck™ foam for the organization your equipment deserves.

Custom case solutions make protecting complex equipment easy. With options like custom engineered deck mount suspension systems and specialized foam options, your equipment stays organized and protected from extreme G-forces.

Pelican also offers a wide range of accessories including custom nameplates, caster wheels, shoulder straps, and TSA locks, making it easier to travel with and transport your gear without concern.



EZ CLICK™ MOLLE PANEL
Attach an unlimited combination of user-supplied MOLLE pouches and Velcro™ straps (not included) to the inside of your case lid.

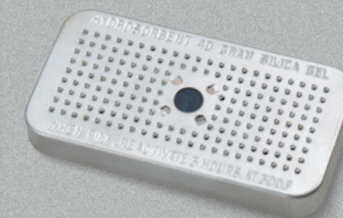

1500D DESICCANT (SILICA GEL)
Absorbs moisture and prevents condensation from forming inside a case in high-humidity climates.



TSA LOCKS
TSA-accepted locks keep thieves out, while allowing the TSA necessary access.

OPTIONS VARY BY PRODUCT



CARD HOLDER
Removeable card holders are ideal for shipping documents and identification cards.



LID ORGANIZER
Zippered mesh pockets keep your smaller equipment organized.



NAMEPLATES
Custom order nameplates make it easier to identify your case.



PALLET RISERS
Pallet risers raise the level of a case to allow forklift forks to slide under.



CASTER WHEEL KITS
Detachable caster wheels can be attached for easier transport and detached for storage.



LID STAYS
Lid stays lock your lid in place to allow access to your equipment without the worry of accidental lid closure.

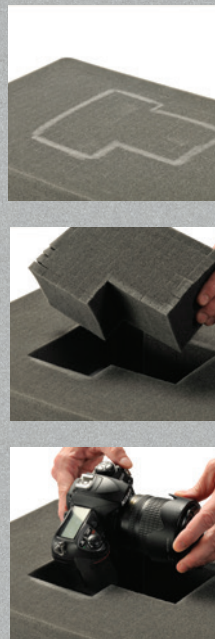

PICK N PLUCK™ FOAM

An easy, do-it-yourself system for the interior of the case. Layers of foam are pre-scored in 1/2" or 1" cubes. Simply lay your equipment on the foam, tape or chalk to mark the foam, and pluck away. Always allow at least one inch of foam between your equipment and the wall of the case.

We offer replacement foam sets online at pelican.com. Just enter the case catalog number in the search field to view available foam sets.

Solid foam (which can be cut with an electric knife or coping saw) is preferred for oversize items such as long guns. The following cases ship with solid foam instead of Pick N Pluck™ Foam: 1700, 1720, 1740, 1750, 1770, iM3100, iM3200, iM3220, iM3300, iM3410



TREKPAK™ DIVIDER & PICK N PLUCK™ FOAM HYBRID INTERIOR

With two NEW Pelican™ Hybrid interiors, organization has been taken to the next level. TrekPak™ dividers and Pick N Pluck™ foam have been combined in two of our most popular cases, the Pelican™ 1510 Protector Case™ and the Pelican™ 1535 Air case. This combination allows for unlimited options to keep your equipment intact, organized and ready to go.

Pick N Pluck™ foam is perfect for fixed solutions and TrekPak™ dividers give you the freedom to adjust the case to your ever-changing accessory needs.

Hybrid configuration available for 1510 (Cat No.1510TPF) and 1535 Air (Cat No.1535TPF)



TREKPAK™ DIVIDER SYSTEM

Now available in our most popular case sizes, our TrekPak™ Divider System is a versatile kit that allows you to organize your case like a pro. Durable, closed-cell foam is laminated to corrugated panels that provide a precise grid of protection without wasting any space.

The TrekPak™ Divider System comes complete with perimeter wall sections installed, divider panels, locking pins and a fool-proof cutting tool. Extra divider material is included and available separately so you can reconfigure your case anytime.



Available in our most popular Pelican™ Protector Case™ Brand Case, Pelican™ Storm Case™ Series, and Pelican™ Air Case sizes. TrekPak™ Divider System also sold separately.



PADDED DIVIDERS

A classic organizational solution. Versatile and durable, padded dividers easily adjust to fit your equipment into any configuration on the fly. Plus, you can quickly identify your gear with the padded divider's high contrast color.

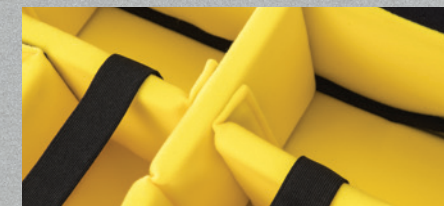

Padded Divider Walls are covered with mountable fabric, providing endless reconfigurations



- O-ring
- Panel Frame/Bezel Kit
- Attachment Hardware

PANEL FRAME AND BEZEL KITS

Many Pelican™ cases can be adapted for use with electronic interface panels by using a Panel Frame (Pelican™ Protector Case™ Series) or Bezel Kit (Pelican™ Storm Case™ Series) accessory. Mount most interface panels (customer supplied) flush with the rim of the Pelican™ Protector Case™ Series or desired area in a Pelican™ Storm Case™ Series, and your technology is ready to go.

A polymer o-ring seals the panel so the base of the case remains watertight, even with the lid open. The mounting bracket, fasteners and o-ring are included in the Panel Frame Kit.

PELICAN™ PROTECTOR CASE™ SERIES WITH PANEL FRAME AVAILABILITY				
CAT. NO.	INTERIOR DIMENSIONS		EXTERIOR DIMENSIONS	
	inches/cm	LxWxH	inches/cm	LxWxH
1120	7.29" x 4.78" x 3.33" (18.5 x 12.1 x 8.5 cm)		8.41" x 6.76" x 3.87" (21.4 x 17.2 x 9.8 cm)	
1150	8.29" x 5.79" x 3.75" (21.1 x 14.7 x 9.5 cm)		9.44" x 7.80" x 4.29" (24 x 19.8 x 10.9 cm)	
1200	9.25" x 7.12" x 4.12" (23.5 x 18.1 x 10.5 cm)		10.62" x 9.68" x 4.87" (27 x 24.6 x 12.4 cm)	
1300	9.17" x 7.00" x 6.12" (23.3 x 17.8 x 15.5 cm)		10.62" x 9.68" x 6.87" (27 x 24.6 x 17.4 cm)	
1400	11.81" x 8.87" x 5.18" (30 x 22.5 x 13.2 cm)		13.37" x 11.62" x 6.00" (34 x 29.5 x 15.2 cm)w	
1430	13.56" x 5.76" x 11.70" (34.4 x 14.6 x 29.7 cm)		16.40" x 8.71" x 13.15" (41.7 x 22.1 x 33.4 cm)	
1450	14.66" x 10.24" x 6.12" (37.2 x 26 x 15.5 cm)		16.44" x 13" x 6.82" (41.8 x 33 x 17.3 cm)	
1470	15.70" x 10.70" x 3.87" (39.9 x 27.2 x 9.8 cm)		16.88" x 13.23" x 4.47" (42.9 x 33.6 x 11.4 cm)	
1490	17.75" x 11.37" x 4.12" (45.1 x 28.9 x 10.5 cm)		19.87" x 13.93" x 4.68" (50.5 x 35.4 x 11.9 cm)	
1500	16.75" x 11.18" x 6.12" (42.5 x 28.4 x 15.5 cm)		18.50" x 14.06" x 6.93" (47 x 35.7 x 17.6 cm)	
1520	18.06" x 12.89" x 6.72" (45.9 x 32.7 x 17.1 cm)		19.78" x 15.77" x 7.41" (50.2 x 40.1 x 18.8 cm)	
1550	18.63" x 14.18" x 7.72" (47.3 x 36 x 19.6 cm)		20.66" x 17.20" x 8.40" (52.5 x 43.7 x 21.3 cm)	

⚠ WARNING: This product can expose you to chemicals including Lead and lead compounds, which are known to the State of California to cause cancer and birth defects or other reproductive harm. For more information go to www.P65Warnings.ca.gov.

PELICAN™ STORM CASE™ SERIES WITH BEZEL KIT AVAILABILITY				
CAT. NO.	INTERIOR DIMENSIONS		EXTERIOR DIMENSIONS	
	inches/cm	LxWxH	inches/cm	LxWxH
iM2050	9.5" x 7.5" x 4.25" (24.1 x 19.1 x 10.8 cm)		11.8" x 9.8" x 4.7" (30 x 24.9 x 11.9 cm)	
iM2075	9.5" x 7.5" x 7.25" (24.1 x 19.1 x 18.4 cm)		11.8" x 9.8" x 7.7" (30 x 24.9 x 19.6 cm)	
iM2100	13" x 9.2" x 6" (33 x 23.4 x 15.2 cm)		14.2" x 11.4" x 6.5" (36.1 x 29 x 16.5 cm)	
iM2200	15" x 10.5" x 6" (38.1 x 26.7 x 15.2 cm)		16.2" x 12.7" x 6.6" (41.1 x 32.3 x 16.8 cm)	
iM2300	17" x 11.7" x 6.2" (43.2 x 29.7 x 15.7 cm)		18.2" x 13.9" x 6.7" (46.2 x 35.3 x 17 cm)	
iM2306	17" x 6.3" x 6.2" (43.2 x 16 x 15.7 cm)		18.2" x 8.4" x 6.7" (46.2 x 21.3 x 17 cm)	
iM2370	18.2" x 12.1" x 5.2" (46.2 x 30.7 x 13.2 cm)		20" x 14.7" x 5.8" (50.8 x 37.3 x 14.7 cm)	
iM2400	18" x 13" x 6.7" (45.7 x 33 x 17 cm)		19.2" x 15.2" x 7.3" (48.8 x 38.6 x 18.5 cm)	
iM2450	18" x 13" x 8.4" (45.7 x 33 x 21.3 cm)		19.2" x 15.2" x 9" (48.8 x 38.6 x 22.9 cm)	
iM2500	20.5" x 11.5" x 7.2" (52.1 x 29.2 x 18.3 cm)		21.7" x 14.1" x 8.9" (55.1 x 35.8 x 22.6 cm)	
iM2600	20" x 14" x 7.7" (50.8 x 35.6 x 19.6 cm)		21.2" x 16" x 8.3" (53.8 x 40.6 x 21.1 cm)	
iM2620	20" x 14" x 10" (50.8 x 35.6 x 25.4 cm)		21.2" x 16" x 10.6" (53.8 x 40.6 x 26.9 cm)	
iM2700	22" x 17" x 8" (55.9 x 43.2 x 20.3 cm)		24.6" x 19.7" x 8.6" (62.5 x 50 x 21.8 cm)	
iM2720	22" x 17" x 10" (55.9 x 43.2 x 25.4 cm)		24.6" x 19.7" x 11.7" (62.5 x 50 x 29.7 cm)	
iM2750	22" x 17" x 12.7" (55.9 x 43.2 x 32.2 cm)		24.6" x 19.7" x 14.4" (62.5 x 50 x 36.6 cm)	
iM2875	22.5" x 21.1" x 11.4" (57.2 x 53.6 x 29 cm)		24.9" x 23.7" x 13.1" (63.2 x 60.2 x 33.3 cm)	
iM2950	29" x 18" x 10.5" (73.7 x 45.7 x 26.7 cm)		31.3" x 20.4" x 12.2" (79.5 x 51.8 x 31 cm)	
iM2975	29" x 18" x 13.8" (73.7 x 45.7 x 35.1 cm)		31.3" x 20.4" x 15.5" (79.5 x 51.8 x 39.4 cm)	

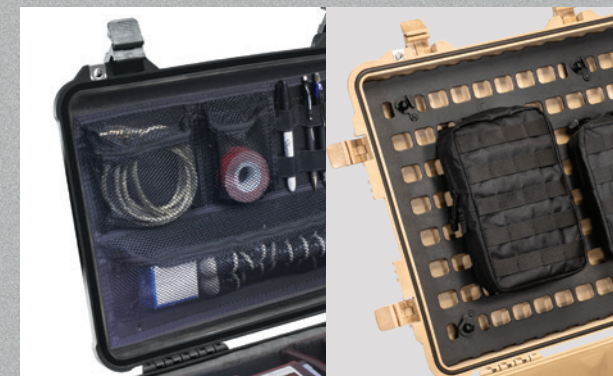

LID ORGANIZERS

Made of simulated leather or ballistic nylon with nylon zippers. A wide variety of pocket sizes protect and keep your gear organized, and install easily with Velcro® strips (included).

The Pelican™ EZ-Click™ MOLLE Panel is a lid organizer system on steroids- it's a durable panel that uses twist-cam locks to detach from your Pelican™ case for a swift changeout.

ELECTRONIC INSTALLATIONS

Many Pelican™ Protector Case™ Series and Pelican™ Storm Case™ Series models allow customization for electronics. Injection molding provides a reliable, durable, ready-to-ship enclosure with consistent dimensions. The copolymer material can be machined, drilled and sanded smooth.

These properties make the Pelican™ Protector Case™ Series and Pelican™ Storm



PELI™ QUICK MOUNTS

An alternative to panel frames, Peli™ Quick Mounts attach to the inside case wall using special adhesives. An interface panel can then be mounted on top of the Peli™ Quick Mounts and secured with screws (for Pelican™ Protector Case™ Series models only).

Case™ Series suitable for use with bulkhead connectors. Attaching equipment to the interior is equally simple using common hardware such as bolts and rivets. The hardware can be made watertight by use of o-rings, rubber gaskets or silicone.

Mounting the entire case to a wall or post is a simple way to create a waterproof control box for field use.



CUSTOM LOGO SERVICES

Personalize the outside of the case with your company logo or have your name engraved on the nameplate (for Pelican™ Protector Case™ Series models only). Logos can be applied in multiple colors as a Mylar® decal (250 piece minimum) or as a vibrant fade-resistant, scratch-resistant hot-stamped ink.

For prices and further information, please call Pelican Customer Service at 310.326.4700 or toll free at 800.473.5422.

CUSTOM CASE SOLUTIONS

www.pelican.com/custom

While every Pelican™ case is built tough on the outside, we provide custom services to protect delicate items on the inside. Custom foam and extreme solutions such as deck mount suspension systems and

certified laboratory testing will keep your equipment organized, intact and protected through the most volatile conditions.

LOW COMPLEXITY

Custom Foam Solutions



MEDIUM COMPLEXITY

Interior/Exterior Solutions

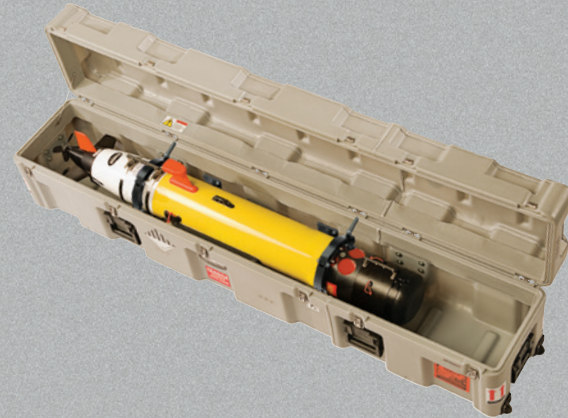

EXTREME COMPLEXITY

Interior/Exterior Solutions with Testing Requirements

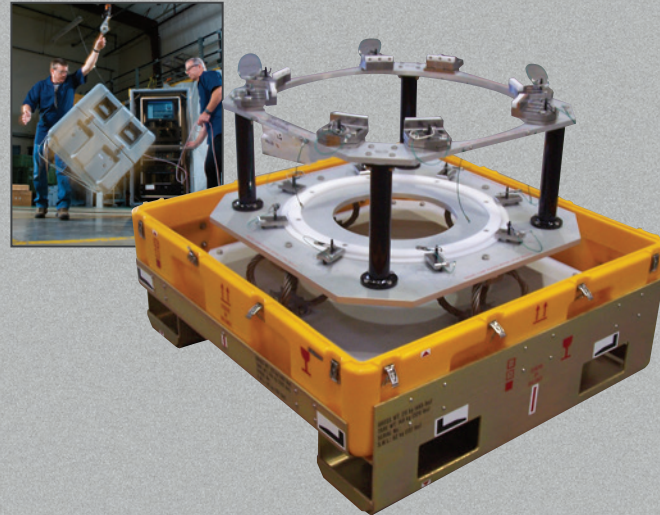

EXAMPLES

- Custom Labels
- Humidity Indicators
- Customizable cushions, such as Polyethylene and Polyurethane, in multiple densities, as well as other specialty foams

EXAMPLES

- Shock Mount Metal Decks
- Custom Metal Work
- Cut and Weld
- Custom Bezel Solutions
- Forklift Risers

EXAMPLES

- Shock Testing
- Vibration Testing
- Drop Testing
- Salt/Fog Testing
- Pressure Testing

CUSTOM FOAM MADE SPECIFICALLY FOR YOUR EQUIPMENT

Pelican Products provides expert packaging solutions for our case lines, and we work with partners who have been in the packaging industry for over 50 years. Save time and cost by purchasing a fast and complete turnkey solution from Pelican.

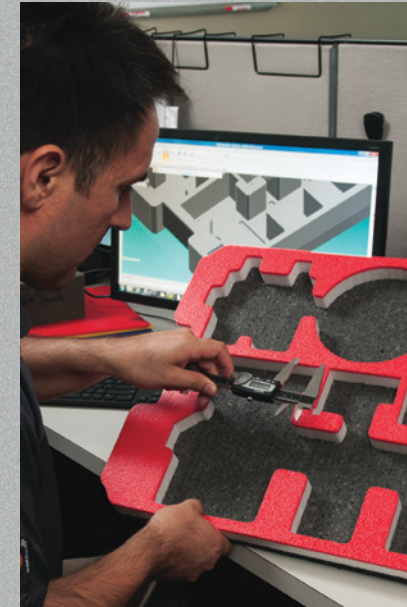
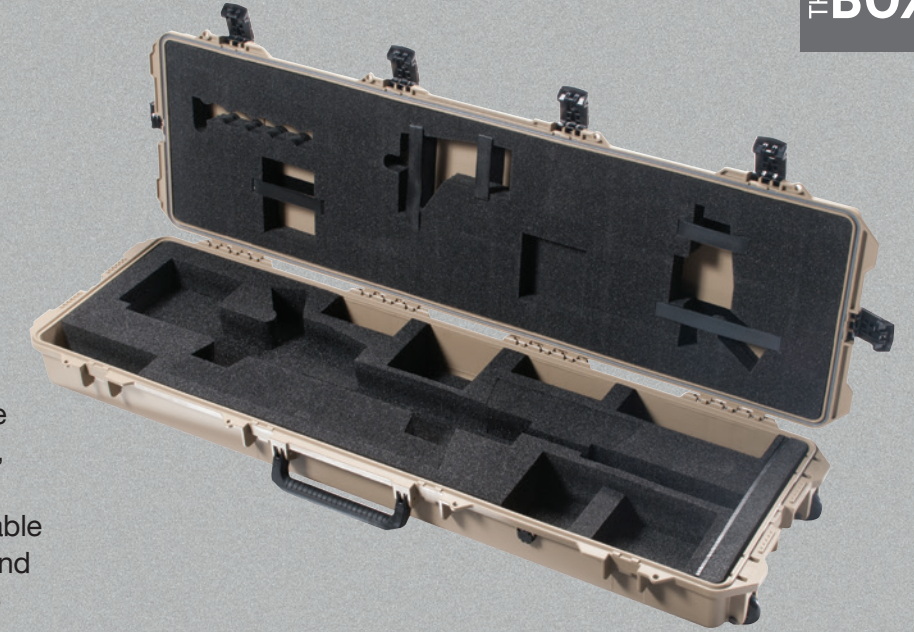

Our Pelican Case Centers have the most advanced foam cutting tools, and our engineers have the latest software applications so they are able to create a design that is precise and determines the most cost effective method of manufacture.

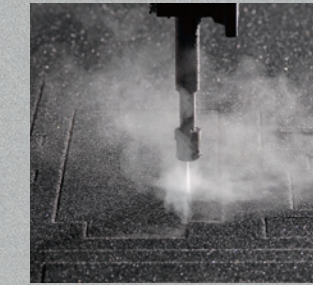

Water Jet Technology



Die Cut Technology



CNC Router Technology

PELICAN ENGINEERS TAKE EVERYTHING INTO CONSIDERATION WHEN DESIGNING YOUR CUSTOM CUSHION:

- Unit Dimensions
- Accessories and Other Items
- Fragility
- Military Specifications
- UV Resistance
- Commercial Spec
- Anti Static Grounding
- Weight and Weight Distribution
- Size Restrictions
- Shipping Method and Frequency (ground, air or "around the town")
- Option Requirements
- ...and more

All of this information allows us to choose the right Pelican™ case and foam type for your application.

NOT ALL FOAM IS EQUAL

With over 50 years of professional packaging experience, Pelican engineers utilize sophisticated engineering technology to provide a foam solution that not only serves to protect, but also creates a professional presentation that you will be proud to display.

From simple to very complex cushion designs, we know how to provide protection that will get your gear or mission critical items safely to their destination.



CUSHIONING MATERIAL

POLYURETHANE:

Commonly used, polyurethane is a softer, open cell foam. Best for lighter weight sensitive equipment such as cameras, smartphones and laptops. Available in a variety of densities.

ANTI-STATIC POLYURETHANE:

This special foam inhibits the build up of static electricity and helps dissipate any stray static charge. It is an open cell foam that is used for lightweight items such as sensitive electronic equipment, e.g. circuit boards, computer chips, etc.

POLYETHYLENE:

Polyethylene foam is a strong, non-abrasive, water-resistant and resilient closed cell foam. Due to its excellent vibration dampening and insulation properties, it is often used for packaging fragile goods such as communications equipment, power supplies, etc. Available in a variety of densities.

ANTI-STATIC POLYETHYLENE:

Commonly used for shipping electronic parts, circuit boards and computer chips, anti-static polyethylene foam is a strong, non-abrasive, water-resistant and resilient closed cell foam. The properties of the foam slowly dissipate electrostatic charges given off by other components. Used for shock absorption, it is often used for packaging fragile goods due to its excellent vibration dampening and insulation properties.

CROSS-LINK:

Is a non-porous, non-particulate closed cell foam that is often used in a clean room environment (reduces foreign object debris – FOD). It is aesthetically pleasing and resistant to grease, dirt and water. Available in a variety of densities.

ADDITIONAL FOAM TYPES ARE AVAILABLE: FLAME-RETARDANT, CONDUCTIVE, EXPANDED FOAMS...

CUSTOM FOAM APPLICATION EXAMPLES:

- Consumer Products
- Firearms
- Computers
- Calibrated Optics
- Tools
- Video Equipment
- Bottles
- Paintings
- Musical Instruments
- Collectibles
- Any Item That You Value and Need To Protect



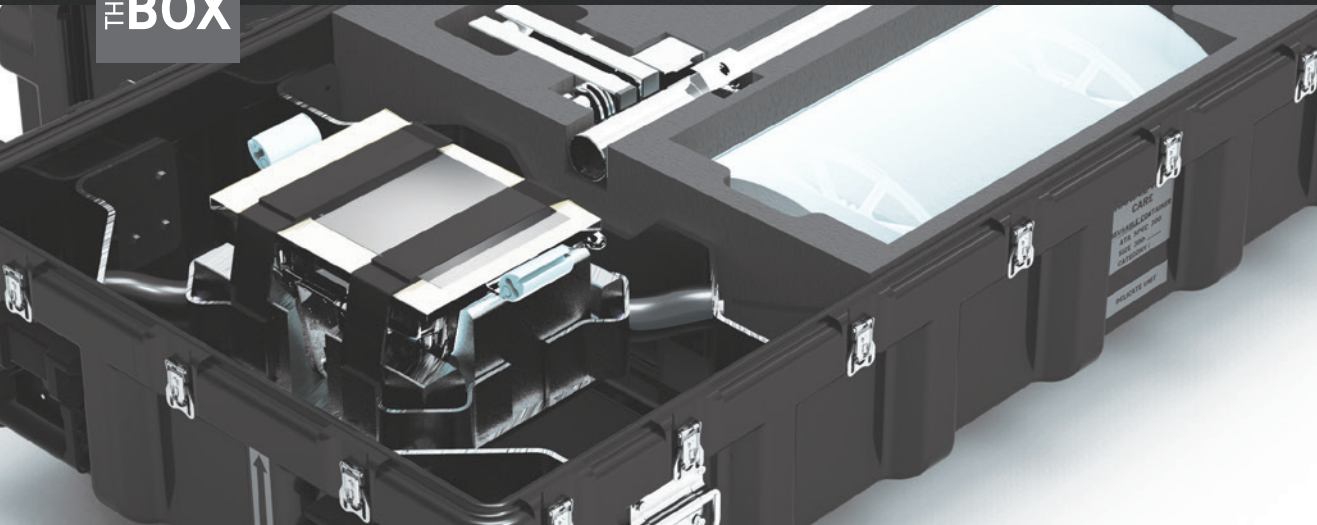

BEYOND FOAM

When foam is not appropriate, Pelican specializes in custom metal work to help keep your equipment secure and stable, to arrive without a scratch.

LAB TESTING

Military and OEM customers may need to certify the case will perform to specific requirements. Under precise control conditions we subject our cases to a battery of rigorous lab tests including drop, vibration, leak, heat and dust tests.

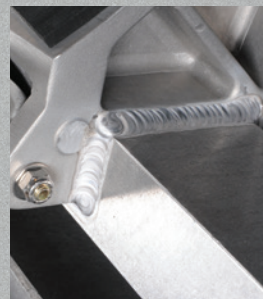

DECK MOUNT SUSPENSION SYSTEM

While foam is generally the first choice for protection, heavy or extremely fragile equipment sometimes requires fabrication of custom deck mount suspension systems to secure equipment. Cradle mounts are also the choice when the equipment can only be supported in precise locations. Pelican's machine shop is world-class, with plasma cutters, certified welders and finishing services demanded by the aerospace, defense and medical industries.

VIBRATION CONTROL

Small but constant vibration during transport is very destructive to the equipment inside a case. Pelican uses elastomer shock mounts, cable shock isolators, hard mounts, and foam that isolate the payload from case walls. Specialized foams can also mitigate vibration; our engineers understand the properties of foam to specify the type that is right for your requirements.



VIBRATION TEST

- L.A.B. servo hydraulic vibration system; 0 – 300 Hz.
- Sinusoidal with pre-programmed profiles for:
 - ISTA Integrity test procedures 11800, 14200, 1A, 1B, 1E, 1C, 1D, 2A AND 2B.
 - FED-STD-101C; 5019-1
 - 3 – 50 Hz sweep with 1G constant input
 - 1 inch dwell for loose cargo bounce
 - Mil-Std-648C; 5.3.2

- Random Vibration with pre-programmed profiles for:

- ASTM D 4169 Air levels 1, 2, and 3
- ASTM D 4169 Truck levels 1, 2, and 3
- ASTM D 4169 Rail levels 1, 2, and 3
- ISTA Integrity Test Procedures 1E, 1H, 1C, 1D, 1F, 3C, 3D, and 3E.

DROP TESTING

- Six foot cube reaction mass of reinforced concrete. A hoist capable of lifting 1 ton, and a quick release mechanism with a load capacity of ½ ton.

IMPACT TEST

- Falling dart – 84 inch drop height with darts weighing between 5 and 15 lbs.
- Penetration test for category 1 containers - ATA 300 paragraph B-2-5

THERMAL TEST

- Walk in environmental chamber 6-foot wide by 8 foot high and 8 feet deep with a thermal range of -100°F to 200°F.

IMMERSION TEST

- Internal dimension of the chamber is 54" x 30" x 36"H. Able to simulate immersions up to 2 meters.
- Small immersion tank capable of immersions up to 1 meter on small IM cases.
- 80 inch deep large immersion tank

RAIN TEST

- Small rain chamber capable of up to 4 inches per hour.

PNEUMATIC PRESSURE TESTING

- 100" and 80" water manometers
- 100" mercury manometer.
- Digital manometer – 10 psi max.

COMPRESSION AND TENSILE TESTING

- Instron compression tester, model 3367.
- Load range of 6600 lbs on small items.

LEAK TEST

- Immersion: 54" x 30" x 36" high chamber. Able to simulate immersions up to 2 meters.
- Rain: Small rain chamber capable of up to 4 in. per hour.
- Pneumatic Pressure: 100" and 80" water manometers. 100" mercury manometer.
- Digital manometer – 10 psi max.



GET 20% TOUGHER AND HUNDREDS OF ADDITIONAL SIZE OPTIONS: ROTATIONALLY MOLDED CASES

Our rotationally molded cases begin as resin powder, measured and loaded into a mold attached to a biaxial arm. As the mold rotates and heats up, the resin coats the inside of the mold and creates the case. As a result of this process, 20% more resin accumulates in the corners and edges where it is needed most to provide impact resistance. This ensures that your case holds up

against extreme drops and impacts.

Each case is made in the USA and all cases are manufactured to MIL810 spec standards. We have 354 cases sizes combined with 7 different style options that allows us to offer the customer 620 configurable cases styles that satisfy any type of technical packaging requirements..

See pelican.com for all case styles and sizes.

CHOICE

Hundreds of case sizes and multiple case styles configured with a wide variety of case options allows us to offer the widest range of standard configurations in the industry.



SINGLE LID CASES

Rugged protection with detachable lids for easy access.

RACK MOUNT CASES

Built-in shock absorbing frames protect electronic equipment.

ISP CASES (INTER-STACKING PATTERN)

Best protection for pallet shipments.

LIGHT LIFT™ CASES.

Up to 30% lighter than standard roto mold cases.

STANDARD ACCESSORIES

Bottom and Side Casters	Edge Casters	Caster Storage in Lid	Comfort Grip Plastic Handles	Metal Handles	Lift Rings/Tie Down Rings	Skid Runners	T-Handles and Bumpers	Flange Mount Cases
Pressure Relief Valve	Humidity Indicators	Locking Cable Catch	Padlock Hasps	Card Holders	Standard and ATA Labels	Front Labels	Custom Stenciling	ID Plates

OPTIONAL COLORS FOR ALL SINGLE LID CASES

Gray – 133 Fed Std# 26270	Tan – 250 Fed Std# 20372	Blue – 135(lt) Pantone# 292U	White – 132 Fed Std# 27925	Yellow – 136 Pantone# 012U	Green – 138(forest) Fed Std# 24052	Orange – 134 Fed Std# 12197
Yellow – 131 Fed Std# 23538	Maroon – 197 Pantone# 202U	Blue – 101(dk) Fed Std# 25052	Black – 032 Fed Std# 27040	Red – 130 Fed Std# 21105	Olive Drab – 137 Fed Std# 34096	Purple – 129 Pantone# 245U

Note: Some options are not available on all case sizes and availability is subject to change at manufacturer's discretion. Case colors/options may differ slightly from printed versions.

MEET THE OTHER HALF OF PELICAN

The same durability and ingenuity built into every Pelican light also sets our other products apart. We're protecting equipment around the world from the toughest environments.

FOR THE FULL LINE OF PELICAN PRODUCTS GO TO WWW.PELICAN.COM



CASES



URBAN AND SPORT BACKPACKS



PELICAN ELITE COOLERS



FLASHLIGHTS



BIO THERMAL



DRINKWARE

INJECTION MOLDED CASES (EXCLUDES VAULT BY PELICAN) - LIMITED LIFETIME WARRANTY

Pelican Products, Inc. ("Pelican") guarantees its injection molded products for a lifetime against breakage or defects in workmanship. Pelican™ injection molded cases are guaranteed to be watertight to a depth of 3.3 feet (1 meter) for 30 minutes (IP 67) if properly closed with undamaged o-ring in place unless otherwise stated. To the extent permitted by law, Pelican's liability is limited to the case and not its contents or foam. Pelican will either repair or replace any broken or defective product, at our sole option.

All warranty claims of any nature are barred if the product has been altered, damaged or in any way physically changed, or subjected to abuse, misuse, negligence or accident. In Australia visit www.pelican.com/support/warranty/. For complete warranty details visit www.pelican.com/support/warranty/. Lifetime Warranty does not cover Vault by Pelican, Cargo mounts or Roto Molded cases. Refer to www.pelican.com/support/warranty/ for full details.

U.S.A.

CALIFORNIA
23215 Early Avenue
Torrance, CA 90505
Tel: 310.326.4700
800.473.5422
Fax: 310.326.3311
www.pelican.com

MASSACHUSETTS
147 North Main Street
South Deerfield, MA 01373
Tel: 800.542.7344
Fax: 413.665.8330
www.pelican.com

MINNESOTA
Pelican BioThermal Headquarters
10050 89th Ave N
Maple Grove, MN 55369
Tel: 763.412.4800
877.537.9800
www.pelicanbiothermal.com

INTERNATIONAL

AUSTRALIA
Pelican Products Pty Ltd
West Wing, Platinum Building,
Suite 2.33, 4 Ilya Av
Erina NSW 2250
Tel: +612 4367 7022
Fax: +612 4367 7066
www.pelicanaustralia.com

CANADA
Pelican Products ULC
10221-184th Street
Edmonton, Alberta
T5S 2J4 Canada
Tel: +780 481 6076
Fax: +780 481 9586
www.pelican.com/ca

CHINA
Pelican Products China Representative Office
Pine City Building, Room 1026
777 Zhaojiabang Road
Shanghai, China 200032
Tel: +86 21 64189685
Fax: +86 21 64189679
www.pelican.com/cn

EUROPE, MIDDLE EAST AND AFRICA
Peli Products, S.L.U.
c/ Provença, 388, Planta 7
08025 - Barcelona, Spain
Tel: +34 934 674 999
Fax: +34 934 877 393
www.peli.com

KOREA
Pelican Products Korea Ltd
#909 Hyundai 41 Tower, #2616
917-9, Mok-dong, Yangchon-gu,
Seoul, Korea 158-050
Tel: +82 2 6092 4700
Fax: +82 2 6739 4700

JAPAN
Pelican Products K.K.
Nisso 22 Bldg 9F
1-11-10 Azabu Dai
Minato ward Tokyo
106-0041 Japan
Tel: +81 33 585 9100
Fax: +81 33 585 9109
www.pelican.com/jp

LATIN AMERICA
23215 Early Avenue
Torrance, California 90505 USA
Tel: +1 310-326-4700 x 1462
Fax: +1 310-325-5740
www.pelican.com

**SE ASIA and Rest of ASIA
(Hong Kong, Macau, Taiwan, Pakistan)**
19 Tukang Innovation Drive
Greenhub #04-01
Singapore 618301
tel: +65 9298 3322
www.pelican.com



©2021 Pelican Products, Inc. All trademarks are registered and/or unregistered trademarks of Pelican Products, Inc., its subsidiaries and/or affiliates. VELCRO® is a registered trademark of Velcro Industries B.V. Mylar® is a registered trademark of E.I. du Pont de Nemours and Company.

Printed in the USA on FSC-Certified Paper

Part No. 0030-000-300 SE/21

DISTRIBUTED BY:

IDEMCO

W : www.idemcosb.com.my
E : idemco@idemcosb.com.my
T : +6 03-7781 7973

