

# STANLEY®

志發  
CHEE FATT

## MASTER CATALOG 2022 (Malaysia)



# STANLEY

## THE HISTORY OF STANLEY® TOOLS

**1843**

The Stanley Works was founded in New Britain, Connecticut by Frederick T. Stanley.

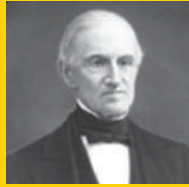

**1863**

Stanley introduced hammers to their line-up.



**1870**

Stanley began manufacturing screwdrivers and hand planes.

**1900**

Rule & Level is the largest manufacturer of planes and related tools in the world.

**1911**

Stanley began manufacturing chisels and vises.

**1921**

A new logo is introduced to symbolize the merger of the Stanley Rule & Level Company and the Stanley Works.



**1936**

Stanley manufactured its first utility knife.



**1937**

Henry Phillips, inventor of Phillips head screw, chose Stanley as the first company to begin making Phillips screwdrivers.

**1844**

Begin to manufacture ivory and boxwood rules.

**1857**

Stanley Rule & Level Company established by Henry Stanley. Stanley begins to manufacture levels and squares.

**1876**

Miter boxes were introduced.

**1869**

Purchased Bailey, Chaney and Company and acquired the right to manufacture tools under Bailey's patents.



**1924**

Stanley filed a patent for the ratcheting screwdriver.

**1928**

The Stanley Works broke into the electric hand tools market with an electric drill, screwdriver and bench grinder.

**1930**

Stanley made the first steel tape rule.

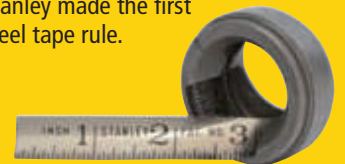

## 1954

Time Magazine published a cover story titled "Do-It-Yourself – The New Million Dollar Hobby". Stanley was ideally positioned to benefit from this trend and quickly developed products for this new market.

## 1980

The Stanley Works was presented the American Eagle Award from the American Supply & Machinery Manufacturers' Associ., Inc. for its "unusual across-the-board quality".



## 1969

The PowerLock Tape Rule represented Stanley as a part of Apollo 11's Lunar Landing Gear.



## 1999

Stanley launched the FatMax Tape Rule and the FatMax AntiVibe Hammer.

## 2013

Stanley launches the next generation of hand tools and power tools.

## 1963

Stanley opens the largest hand tool plant in the world in New Britain, CT. The same year, they introduce the PowerLock Tape Rule.



## 1998

Stanley acquires ZAG Industries Lt., an Israeli maker of plastic storage products, including tool boxes.



## 2011

Stanley launched Carbide blades.

## 2008

Stanley re-introduces Sweetheart planes.



## 1970

Stanley began producing manual staplers.

# ACHIEVING OUTSTANDING PERFORMANCE WITH STANLEY® TOOLS

## A BRAND YOU CAN TRUST

For over a century, we have built a legacy by producing some of the most well known hand tools and storage products in the world, all to help you build a legacy of your own. It is this rich history of innovation that has made **STANLEY®** a trusted name and industry pioneer.

In 1843, **STANLEY®** started to manufacture bolts, hinges, and other hardware by using wrought iron. By merging superior quality materials, constant innovation, and rigorous operational improvements, **STANLEY®** defined excellence until today, is trusted by professionals on job sites around the globe.



## FULL RANGE OF PRODUCTS FOR ALL PROFESSIONALS

**STANLEY®** provides a broad range of over 2,000 products in all tool categories. No matter what car you drive, what stores you shop at, or what building you work in, you can bet that we deliver the tools and solutions that you can count on, and you can be sure that we will keep making them better.

## QUALITY THAT EXCEEDS STANDARDS

Most of the products produced by **STANLEY®** exceed government and industry standards such as ASME/ANSI, ISO and DIN. We push ourselves every day to deliver tough, strong, and reliable hand tools. We have state-of-the-art test facilities that cover solvent resistance and drop testing to ensure that our products meet critical standards. In each product category, we also perform specific performance and life tests to ensure product durability and quality.



Hardness Test



Corrosion &  
Solvent Test



Drop Test



Proof Torque

# STANLEY® HELPS YOU GET THE JOB DONE RIGHT.

## INNOVATIVE DESIGN WITH GREAT FUNCTIONALITY

STANLEY® designs tools based on end user research and user insights. Our innovative processes are fashioned to determine what users want even before they know it. The brand new range of STANLEY® tools meet the demanding nature of all professionals within construction, renovation and automotive sectors. We are the pioneers in many hand tool categories and have created several patented features focused on solving problems faced by users. We have dedicated product design practices that tap into professional needs to conceptualize products that offer the best user benefits. From the field straight to the design team, we strive to offer valuable benefits to all professionals.

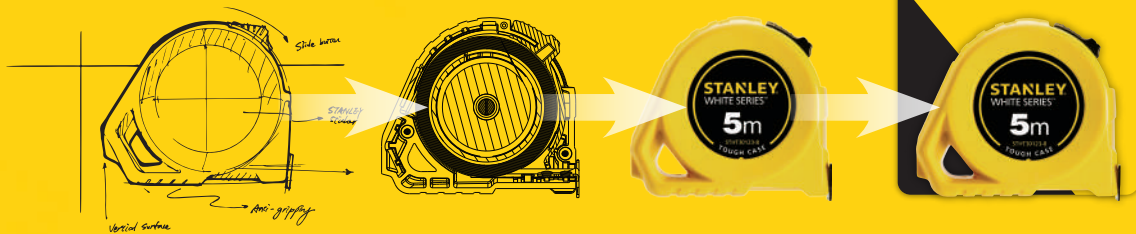

## MANUFACTURING

STANLEY® has been managing and manufacturing tools for over a century. The company has built a brand synonymous with quality and assurance. Facilities located all over the world meticulously churn out quality tools to meet the ceaseless demands of our clients. Our best-in-class manufacturing process ensures that the final product is something to be proud of.

## STANLEY® GLOBAL PRESENCE

- 20+ Global manufacturing sites and labs with similar process and quality controls for consistent quality.



USA



THAILAND



CHINA

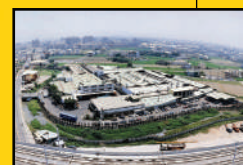

TAIWAN

# STANLEY®

# A STORY BEHIND EVERY TOOL

STANLEY® has been manufacturing high quality tools since 1834, well before Henry Ford's Model T and Orville and Wilbur's fun fly at Kitty Hawk. Ten years later, A.Stanley & Company was founded and began producing folding wooden rules for carpenters and other tradesmen. From those humble beginnings, STANLEY® Tools grew to become today's gold standard by which other hand tools are measured.

In 12 March 2010, STANLEY® completed a merger with the Black & Decker Corporation. Black & Decker is a leading global manufacturer and marketer of power tools and accessories, hardware and home improvement products, and technology-based (engineered) fastening systems. With the merger, StanleyWorks changed its name to Stanley Black & Decker, Inc. The combination would bring together two companies whose product lines are complementary. STANLEY®, a diversified industrial company that sells hand tools and construction equipment, while Black & Decker is known for its power tools.

The organization's purpose has then burgeoned, leading to embrace a refined approach in the way the organization handles its everyday operations and interactions. Looking to communicate the breadth of its offering and establish a unified brand, STANLEY® introduced a new logo and identity, modernizing it as one of the most recognizable brands in the world. The new brand identity exemplifies STANLEY®'s 170-year reputation for innovation, quality and performance. This change is the result of a rebranding effort designed to mirror the growth and transformation of the STANLEY® brand throughout the years.

Today, STANLEY® is proud of its reputation for excellence. STANLEY® is dedicated to continually test, design and improve its products to ensure quality and maximum function. The product offerings range from measuring & layout tools, to cutting & fastening tools, and spans across power tools and accessories. So regardless of whether you're a professional contractor, a do-it-yourselfer – you can always trust the quality and accuracy of STANLEY® tools, as people have for nearly 8 generations.



“ DOUBLE POINTS  
DOUBLE VALUE ”

# CONTENTS

Section 1 - Measuring & Layout Tools	02
Section 2 - Cutting And Holding Tools	14
Section 3 - Fastening Tools	38
Section 4 - Striking & Struck Tools	52
Section 5 - Painting And Finishing Tools	60
Section 6 - Mechanic Tools	72
Section 7 - Tools Storage	114

# 1 MEASURING AND LAYOUT TOOLS

## ACCURACY, DEPENDABILITY & DURABILITY

STANLEY®'s measuring innovation has established STANLEY® as a leading worldwide Tape Rule manufacturer. Our expanded line builds on this great heritage. For example, our new FatMax® Xtreme™ Tape Rules features 13" of blade standout, the longest in the world. We've also improved on classics by adding BladeArmor™ Coating to FatMax® and FatMax® Xtreme™ Tape Rules to extend the life of the blade. And that's only the beginning. Take a look at our tape line and see why after years of innovation, STANLEY®'s Tape quality and durability are unmatched.

### WHY STANLEY® SHORT TAPES?

#### 1 Blade Stand Out

- 1-1/4" Wide Tape Rule Blade - 40% Longer Standout
- Selective Cross-Curve Blade -10-15% Longer Standout
- Multi-Catch End-Hook -Top, bottom, side-side catch utility

#### 2 Product Durability

- BladeArmor – 2x Longer Life
- Multi-Layer Blade Armor – Blade Life
- Chemically Bonded Tape Case Elastomer grip – Bi-Mat Grips

- Hi-Vis Mylar – Easy to read in low lighting (patent pending)
- Bi-Material Wear Plate – 500x Longer Life
- Hook Bend Protection – Extends End-hook Life
- Bi-Material Slide Lock – Crush Proof

#### 3 Compact Case / Longer Blade Length

- 1-1/4" Wide Spring & Micro-Hub - 10% Smaller case

#### 1 Blade durability: stronger, less/ no breakage

- New "fiber" co-extrusion process
- 3/4" Wide Blade
- 50% more Reinforcing strands (+5x)
- Low Temp "PVC" (+15 - 10c)
- BladeArmor End Reinforcement (+2x)

#### 2 Blade Abrasion resistance: print longevity

- Extruded over-coat Clear PVC (+500%)

#### 3 Retraction Speed: Fast

- Gear Drive 3:1

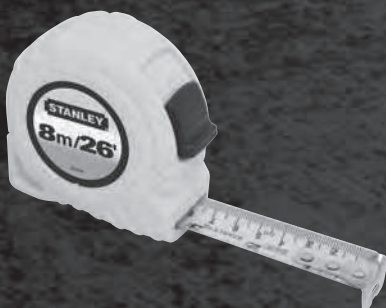



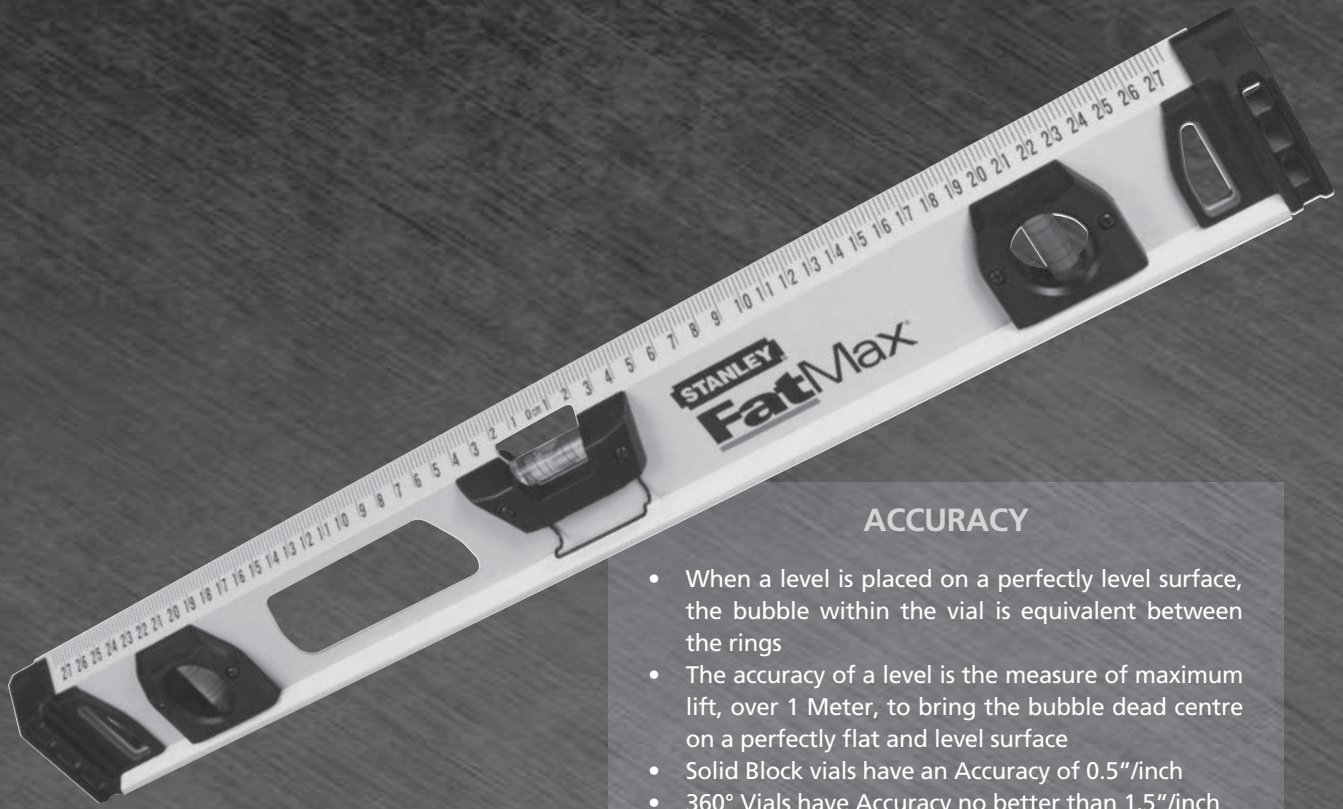

### ACCURACY

- When a level is placed on a perfectly level surface, the bubble within the vial is equivalent between the rings
- The accuracy of a level is the measure of maximum lift, over 1 Meter, to bring the bubble dead centre on a perfectly flat and level surface
- Solid Block vials have an Accuracy of 0.5"/inch
- 360° Vials have Accuracy no better than 1.5"/inch

### TYPES OF LEVELS

#### BOX

- Magnetic
- Non-Magnetic

#### I-Beam

- Magnetic
- Non-Magnetic

#### TORPEDO

- Magnetic



For half a decade, STANLEY® has stayed true to the iconic image of the PowerLock® Tape Rule, improving only on its performance and durability. Furthermore, STANLEY® has maintained the heritage of manufacturing tapes in New Britain, CT, USA\*. This tape design is a dedication to the original PowerLock®, brandishing the same design and markings of the first PowerLock® Tapes manufactured in 1963. Since its launch 50 years ago, it remains one of the best selling tapes in the world. Each PowerLock® Tape features a sliding lock, holding the blade in place, a rigid 7 feet standout Mylar® protective blade coating for durability and a Tru-Zero™ end hook for accurate measurements. Get your 50<sup>th</sup> Anniversary PowerLock Tape Limited Edition Today! Whilst stocks lasts.

\*Manufactured with global materials.



# 1 MEASURING & LAYOUT TOOLS

## MEASURING TAPE SELECTION GUIDE

SHORT TAPES	STANDOUT	TAPE WIDTH	CASE MATERIAL	CASE COLOR	LENGTH	
					METRIC	IMPERIAL
RubberGrip Tape Rule		1/2"	ABS/Rubber	Yellow/Black	3m, 3.5m, 5m	-
Global Tape Rule		1/2", 3/4", 1"	ABS	Yellow	3m, 5m, 8m	10', 16', 26'
Tylon Tape Rule		1"	ABS/Rubber	Yellow/Black	5m, 8m	16', 26'
LeverLock Tape Rule		1/2", 3/4", 1"	ABS	Yellow/Black	3m, 5m, 8m	10', 16', 26'
PowerLock Tape Rule	8'	1/2", 3/4", 1"	ABS Chromed	Chrome	3m, 3.5m, 5m, 8m, 10m	10', 12', 16', 26', 33'
FatMax Tape Rule	11'	3/4", 1", 1-1/4"	ABS/Rubber	Yellow/Black	5m, 8m, 10m	16', 26', 33'
FatMax Xtreme Tape Rule	13'	1-1/4"	ABS Chromed	Yellow/Black	5m, 8m, 10m	-

LONG TAPES	TYPE	TAPE WIDTH	CASE MATERIAL	CASE COLOR	LENGTH	
					METRIC	IMPERIAL
Fiberglass Long Tape	Open Reel	1/2"	ABS/Rubber	Yellow/Black	30m, 60m	100', 200'
	Closed Reel	1/2"	ABS	Yellow/Black	10m, 15m, 20m, 30m, 50m	50', 100', 165'
Stainless Steel Long Tape	Closed Case	3/8"	ABS	Yellow/Black	15m, 20m, 30m	50', 100'

# 1 MEASURING & LAYOUT TOOLS

## STANLEY® RubberGrip® Tape Rule



- Exclusive cushion grip built into case for comfortable non-slip and impact resistance
- Lacquered blade for maximum durability
- Improved blade readability with high contrast colour easy to read in all lighting conditions
- Massive bumper designed for increased hook life

SKU#	BLADE LENGTH		BLADE WIDTH		BOX/CTN
	feet	meters	inches	mm	
30-608L	-	3	½"	12.7	6/36
30-611L	12	3.5	½"	12.7	6/36

## STANLEY® Tylon Tape



- Durable blade coating for Long lasting scale protection continually easy to read
- 16" and 19.2" stud center markings simplify framing jobs
- Compact, ergonomic case is 10% smaller than PowerLock® classic tapes, making it perfect for smaller settings
- Double-end Big Hook for great grip and easy measure
- 3-rivet, corrosion-resistant hook moves for accurate inside/outside measurements
- Forward blade lock design simplifies locking and unlocking the blade
- Full rubber case provides sturdy, anti-slip hold and shock resistant

NEW SKU#	DESCRIPTION	BLADE		BOX/CTN
		Length	Width	
STHT36193	Stanley Tylon Short Tape Rule	3m/10'	13mm	6/36
STHT36194	Stanley Tylon Short Tape Rule	5m/16'	19mm	6/36
STHT36195	Stanley Tylon Short Tape Rule	8m/26'	25mm	6/36

## STANLEY® Powerlock® Tape Rule



- Highly resistant chrome plated plastic case
- Belt Clip
- Tru-Zero hook
- Class II Accuracy
- Anti abrasion Mylar® polyester film coated blade for long life

NEW SKU#	SKU#	BLADE LENGTH		BLADE WIDTH		Box/CTN
		feet	meters	inches	mm	
STHT33215-8	33-215-2	12'	3.5	1/2"	13	6/36
N/A	STHT33158-8	16'	5	3/4"	19	6/36
N/A	STHT33428-8	26'	8	1"	25	6/24
STHT33463-8	33-463-2	33'	10	1"	25	6/24

1 MEASURING & LAYOUT TOOLS

2 CUTTING & HOLDING TOOLS

3 FASTENING TOOLS

4 STRIKING & STRUCK TOOLS

5 PAINTING & FINISHING TOOLS

6 MECHANIC TOOLS

7 TOOLS STORAGE

# 1 MEASURING & LAYOUT TOOLS



## STANLEY® Contractor Grade™ Open Reel Fiberglass LongTape

- 26 Strand 12mm wide blade
- PVC blades allow wound wet and easily cleaned
- Metric English blade printed both sides
- Bi-material handle and shaped winder for ease of use
- Class III Accuracy
- High-impact ABS case withstands rugged conditions

NEW SKU#	SKU#	BLADE LENGTH		BLADE WIDTH		Box/CTN
		feet	meters	inches	mm	
STHT34791-8	34-791	100'	30	1/2"	13	2/8
STHT34794-8	34-794	200'	60	1/2"	13	2/8
STHT34792-8	34-792	-	30	-	13	2/8
2-34-777	34-777	330'	100	1/2"	13	2/8



## STANLEY® Fiberglass LongTape

- 26 strands, 12mm wide blade
- 2 colour graduations - easy to read in all conditions
- High impact, high visibility yellow ABS case
- Handle folds for storage
- Class III Accuracy

NEW SKU#	SKU#	DESCRIPTION	BLADE LENGTH		BLADE WIDTH		Box/CTN
			feet	meters	inches	mm	
STHT34260-8	34-260	LONG TAPE CLOSED	50"	15	1/2"	13	6/60
STHT34262-8	34-262	LONG TAPE CLOSED F/G 30M	100'	30	1/2"	13	6/42
STHT34263-8	34-263	LONG TAPE CLOSED	165'	50	1/2"	13	6/36
STHT34297-8	34-297	FIBERGLASS LONG TAPE CASE 30M	-	30	-	13	6/42
STHT34298-8	34-298	FIBERGLASS LONG	-	50	-	13	6/36

# 1 MEASURING & LAYOUT TOOLS



## STANLEY® Steel LongTape

- 9.5mm wide yellow blade with abrasion resistant polymer coating for durability
- 2 colour graduations - easy to read in all conditions
- High impact, high visibility yellow ABS case
- Hook with spurs for ease of use
- Class III Accuracy

NEW SKU#	SKU#	DESCRIPTION	BLADE LENGTH		BLADE WIDTH		Box/ CTN
			feet	meters	inches	mm	
STHT34104-8	34-104N	15M/50' STEEL LONG TAPE	50'	15	3/8"	9.5	6/24
STHT34107-8	34-107N	30M/100' STEEL LONG TAP	100'	30	3/8"	9.5	6/24
0-34-105	34-105N	STEEL LONG TAPE 20M	-	20	-	9.5	6/24
0-34-108	34-108N	STEEL LONG TAPE 30M	-	30	-	9.5	6/24

## New STANLEY® High Impact ABS Level



- Durable, shock-resistant ABS construction
- Top-read center vial for improved readability
- Measuring scale adds utility
- Non-marring material helps prevent damage to finished surfaces
- High-visibility yellow is easy to spot on the job site

SKU#	DESCRIPTION	LENGTH		BOX/CTN
		inches	# OF VIALS	
STHT42466-8	Plastic, Non-Magnetic	12"	3	-/10
STHT42467-8	Plastic, Non-Magnetic	18"	3	-/6
STHT42468-8	Plastic, Non-Magnetic	24"	3	-/6

NEW SKU#	SKU#	DESCRIPTION	LENGTH		BOX/CTN
			inches	# OF VIALS	
1-42-475	42-475	Plastic, Non-Magnetic	45"	3	-/6

1 MEASURING & LAYOUT TOOLS

2 CUTTING & HOLDING TOOLS

3 FASTENING TOOLS

4 STRIKING & STRUCK TOOLS

5 PAINTING & FINISHING TOOLS

6 MECHANIC TOOLS

7 TOOLS STORAGE

# 1 MEASURING & LAYOUT TOOLS



## New STANLEY® Classic Box Level



- Solid block center vial magnified for easier reading and accurate to 0.0005in/in and 0.5mm/m
- Enlarged plumb vials over 25% larger than standard vials for easy reading
- Plumb vials feature clear covers for protection and easy cleaning
- Shock-absorbing end caps protect level
- New concave body design provides durability and comfortable handling

SKU#	DESCRIPTION	LENGTH cm	# OF VIALS	BOX/CTN
STHT43118-8	Level 30cm/12", 2V Classic Box	30	2	-/10
STHT43102-8	Level 40cm/16", 2V Classic Box	40	2	-/10
STHT43103-8	Level 60cm/24", 2V Classic Box	60	2	-/10
STHT43104-8	Level 80cm/31", 2V Classic Box	80	2	-/10
STHT43105-8	Level 100cm/40", 3V Classic Box	103	3	-/10
STHT43106-8	Level 120cm/48", 3V Classic Box	120	3	-/10
STHT43107-8	Level 150cm/60", 3V Classic Box	150	3	-/6

## New STANLEY® Classic Box Level (Magnetic)



- Solid block center vial magnified for easier reading and accurate to 0.0005in/in and 0.5mm/m
- Enlarged plumb vials over 25% larger than standard vials for easy reading
- Plumb vials feature clear covers for protection and easy cleaning
- Shock-absorbing end caps protect level
- New concave body design provides durability and comfortable handling
- Precision milled utilite surface for accuracy

NEW SKU#	SKU#	DESCRIPTION	LENGTH cm	# OF VIALS	BOX/CTN
STHT1-43110	43-110	Magnetic	40	2	-/10
STHT1-43111	43-111	Magnetic	60	2	-/10
STHT1-43112	43-112	Magnetic	80	2	-/10
STHT1-43113	43-113	Magnetic	100	3	-/10
STHT1-43114	43-114	Magnetic	120	3	-/10
STHT1-43115	43-115	Magnetic	150	3	-/6
STHT1-43117	43-117	Magnetic	200	3	-/6

## New STANLEY® Standard Box Beam Level



- Full Range With 3 Vials, top read vial, 90° plumb vial and 45° view vial
- Lightweight Aluminum Body
- Solid Acrylic Block Vials Resistant to direct impact, offer better visibility, readability, durability and accuracy

SKU#	DESCRIPTION	ACCURACY	LENGTH		BOX/CTN
			(inch)	(mm)	
STHT42796	Standard Box Beam Level 30cm/12"	1mm/m	12	300	10
STHT42797	Standard Box Beam Level 40cm/16"	1mm/m	16	400	10
STHT42798	Standard Box Beam Level 60cm/24"	1mm/m	24	600	10
STHT42813	Standard Box Beam Level 100cm/39"	1mm/m	39	1000	10
STHT42833	Standard Box Beam Level 120cm/48"	1mm/m	48	1200	10

# 1 MEASURING & LAYOUT TOOLS

## New STANLEY® I-Beam Level



- Lightweight aluminum body
- Robust I-Beam construction for increased durability and rugged use
- 270° Vial window easy to read vial from top and two sides

NEW SKU#	DESCRIPTION	LENGTH		BOX/CTN
		inch	# OF VIALS	
STHT42072-8	Stanley I-Beam Level	12"	2	20/20
STHT42073-8	Stanley I-Beam Level	18"	3	10/10
STHT42074-8	Stanley I-Beam Level	24"	3	10/10
STHT42075-8	Stanley I-Beam Level	36"	3	10/10
STHT42076-8	Stanley I-Beam Level	48"	3	10/10

## New STANLEY® Fatmax I-Beam Level (Magnetic)



- Aluminum body removes excess dirt and prolongs life
- Solid vials for better control and less slips
- Magnified center vial for more user comfort
- Vials accuracy of 0.5mm/m for improved accuracy
- Top read scale for fast measurements
- MaxEdge center vial : bridged center vial for continuous marking surface
- Shock absorbing end caps makes it long lasting & choc resistant

SKU#	DESCRIPTION	LENGTH inches	# OF VIALS	BOX/CTN
43-554	Magnetic	24"	3	2/2
43-556	Magnetic	48"	3	2/2
43-558	Magnetic	78"	3	2/2

## STANLEY® Contractor Grade™ Torpedo Level



- Combines accuracy and lightweight, ideal for all small installations
- 3 vials: horizontal, plumb and 45°

NEW SKU#	SKU#	mm	inches	#OF VIALS	BOX/CTN
STHT42465-8	42-465	229	9"	3level/45°/1Plumb with Magnetic Base	6/36

1 MEASURING & LAYOUT TOOLS

2 CUTTING & HOLDING TOOLS

3 FASTENING TOOLS

4 STRIKING & STRUCK TOOLS

5 PAINTING & FINISHING TOOLS

6 MECHANIC TOOLS

7 TOOLS STORAGE

# 1 MEASURING & LAYOUT TOOLS



## STANLEY® Torpedo Level

- High-impact ABS plastic for durability
- Handy and economical
- 3 vials: horizontal, plumb and 45°

NEW SKU#	SKU#	DESCRIPTION	LENGTH		# OF VIALS	BOX/CTN
			mm	inches		
STHT42264-8	42-264	Magnetic	229	9"	3(level/45°/1Plumb)	6/36
STHT42291-8	42-291	Magnetic	203	8"	3(level/45°/1Plumb)	4/36



## STANLEY® Steel Rafter / Roofing Square

- Embossed graduations and figures on work-hardened steel
- Metric roofing table
- Buffed finish with a clear lacquer that resists rust

SKU#	FINISH	LENGTH		GRADUATION		BOX/CTN
		BODY	TONGUE	FACE	BACK	
45-530 (Metric)	Buffed	600 x 400mm	400 x 38mm	2mm	2mm	6/6



## STANLEY® Steel Carpenter Square

- Tempered steel designed for durability
- Deep graduations for easy reading on face and back
- Surface protected with a clear finish that resists rust
- Reverse reading scale makes measuring more efficient

SKU	FINISH	LENGTH		GRADUATION		BOX/CTN
		BODY	TONGUE	FACE	BACK	
45-500 (Imperial)	Buffed	24" x 16"	16 x 1- 1/2"	1/8"	1/8"	1/4
45-600 (M/E)	Buffed	24" x 16"	16 x 1- 1/2"	1/8"	1/8"	6/6



## STANLEY® Try Square

- Try square with stamped graduations and figures
- Cast zinc handle
- Metric / Imperial marking on ruler

NEW SKU#	SKU#	BLADE		HANDLE		BOX/CTN
		mm	inches	mm	inches	
STHT46530-8	46-530	152	6"	124	4-7/8"	10/10
STHT46532-8	46-532	203	8"	124	4-7/8"	10/10
STHT46534-8	46-534	254	10"	184	7-1/4"	10/10
STHT46536-8	46-536	305	12"	184	7-1/4"	10/10



# 1 MEASURING & LAYOUT TOOLS

## STANLEY® Combination Square

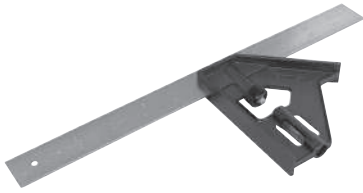

- Try square with stamped graduations and figures
- Cast zinc handle
- Metric / Imperial marking on ruler

SKU#	DESCRIPTION	LENGTH inches	# OF VIALS	BOX/CTN
46-143	Combination, Metric, 11-13/16"	12"	1	10/60
46-012	12"	12"	1	6/6
46-028	Die cast	12"	1	3/3

## STANLEY® Bevel Edge



- High carbon steel-tempered blade
- Nickel-plated
- Tough plastic handle

SKU#	DESCRIPTION		O/ A LENGTH		BOX/CTN
	mm	inches	mm	inches	
46-825-0	203	8"	140	5-1/2"	6/36

## STANLEY® Powerwinder® Chalk Line



- 3 1/2 to 1 gear ratio-rewind 3.5x faster
- Quick gear release-crank will not spin when pulling out line
- Clear view case-see amount of chalk inside case
- Case holds over 1.5 oz. of chalk
- Sliding door for quick and easy refill
- Weight and style combination provides "plumb bob" utility
- High impact ABS case

SKU#	LENGTH		BOX/CTN
	meter	feet	
47-460	30	100	1/6

1 MEASURING & LAYOUT TOOLS

2 CUTTING & HOLDING TOOLS

3 FASTENING TOOLS

4 STRIKING & STRUCK TOOLS

5 PAINTING & FINISHING TOOLS

6 MECHANIC TOOLS

7 TOOLS STORAGE

# 1 MEASURING & LAYOUT TOOLS



## STANLEY® Powerwinder® w/ Red Chalk And Line Level

- Kit contains one 100ft (30m) polypropylene chalk reel and 4oz (113gm)chalk container with blue chalk
- 3 1/2 to 1 gear ratio for 3.5 times faster rewind
- ClearView case to see the amount of chalk left inside
- Case holds 45g chalk
- Weight and style combination provides plumb bob utility
- Stainless steel end hook does not rust
- Sliding door for quick and easy refill

SKU#	LENGTH		BOX/CTN
	meter	feet	
47-465	30	100	5/5



## STANLEY® Chalk Line

- On-board hook storage
- High impact ABS case for durability
- Sliding door for quick and easy refill
- Stainless steel end hook for added durability and rust prevention
- 1oz. chalk capacity

New SKU#	SKU#	LENGTH		BOX/CTN
		meter	feet	
STHT 47440-8	47-440	30	100	6/24



## STANLEY® w/ Blue Chalk And Line Level

- Kit contains 30m chalk line, 113g blue chalk
- High Impact ABS case for durability
- Sliding door for quick and easy refill
- Stainless steel end hook does not rust
- 30g chalk capacity
- Can be used vertically as a plumb bob

New SKU#	SKU#	LENGTH		BOX/CTN
		meter	feet	
STHT 47443-8	47-443	30	100	2/6

# 1 MEASURING & LAYOUT TOOLS



## STANLEY® Chalk Refills

- Powder specially formulated for good adhesion and high visibility
- Water Resistant
- Good resistance to all atmospheric conditions
- Blue: All round colour for interior and exterior use
- Red: Easier to use for external masonry work, inedible, easy to use

NEW SKU#	SKU#	WEIGHT		COLOUR	BOX/CTN
		grams	ounce		
47-803-1-23	47-803-1	226	8	Blue Powder	12/12
47-804-1-23	47-804-1	226	8	Red Powder	12/12



## STANLEY® Marking Gauge

- Plastic marking gauge
- Plastic stock with metal insert for abrasion resistance
- Stem calibrated for easy setting
- Graduation at 2mm

SKU#	DESCRIPTION	BOX/CTN
47-064	STANLEY® Marking Gauge	5/30



## STANLEY® Solid Brass Plumb Bob

- Screw top to easily attach string to center of plumb
- Polished lacquered solid brass construction resists rust
- Thru hole for easy tightening
- Additional tip included on 8 oz size

SKU#	WEIGHT		LENGTH		BOX/CTN
	grams	ounce	mm	inches	
47-973	226	8	133	5 -1/4"	6/36

# 2 CUTTING AND HOLDING TOOLS

## DURABLE, SHARP AND ERGONOMIC

STANLEY® manufactured its first utility knife back in 1935, and it didn't take long for the world to take notice. Compact, rugged, comfortable to hold and armed with a razor-sharp blade, it quickly became an indispensable tool for a wide variety of tradesmen, fabricators and installers. STANLEY® now makes nearly 60 different sizes and styles of utility knives. Specialty knives and blades manufactured for specific tasks, such as cutting carpeting, roofing materials, acrylic sheets, plastic laminates, linoleum and even sod. Some of the many features STANLEY® developed and first brought to market include its interlocking nose, which securely locks together the two knife halves for precise cutting, and an Instant Change™ design that allows you to quickly change blades without using a screwdriver to open the knife. This ingenious "no tools required" blade changing solutions on our utility knives and innovations like SharpTooth™ technology that enable our saws to cut wood 50% faster than conventional saws, sets us apart from our competitors.

### FIXED BLADE KNIVES

These are designed for the heaviest of applications. Although the blade is fixed, the majority of STANLEY® Fixed Blade Knives incorporate a rapid blade changing mechanism.



### RETRACTABLE BLADE KNIVES

These offer similar performance to the fixed blade models and the blade can be retracted safely into the handle when not in use.



### SNAP-OFF BLADE KNIVES

The snap-off blade offers constant sharp edges, but is also strong and thick enough to apply heavy pressure without the blade breaking.



### 9MM SNAP-OFF BLADE KNIVES

The thinner 9mm Snap-off blade is ideal for thinner more delicate sheet materials and general craft work.



## SAW SELECTION CRITERIA

There are three criterion upon which a saw could be judged :

1. The **SHAPE** of the teeth



2. The **SET** of the teeth



3. The **SHARPNESS** of the teeth



### SHAPE & SIZE OF SAW TEETH



UNIVERSAL

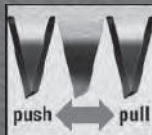

JET CUT

The **SHAPE** and **SIZE** of the teeth determines the Speed of the saw and the Smoothness of the cut.

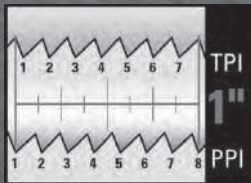

Low No. TPI :



fast cut, coarse finish

High No. TPI :



slower cut, smooth finish

\* This is always denoted as the number of Teeth Per Inch (T.P.I.) and Points Per Inch (P.P.I.)

### SET OF SAW TEETH

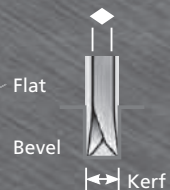

#### Teeth SET in Patterns:

Left, Right, Middle, Middle or Left x3, Middle, Right x3

Middle Teeth have no set and act as Rakers to clear out sawdust

### PERFORMANCE

STANLEY® cutting tools are the best in its class, having features that ensure durability and performance such as:

- Blade Armor
- Tri-Material handle
- Sharpness and cutting life
- Application Specific
- Comfort and Ergonomic Instant-Change Handle

STANLEY® knives and blades are designed to work together to be more efficient, faster, safer and durable. In other words, the only things our tools don't cut are corners.

## 2 CUTTING AND HOLDING TOOLS



### FatMax® Xtreme™ Twin Blade Knife



- 2 knives in 1 - new twin blade design allows the user to alternate between 2 blades without carrying more than 1 knife
- InstantChange™ feature allows the user to replace dull blades in seconds
- Easy access blade storage holds up to 9 blades for fast and easy blade change
- Interlocking blade sliders so that only 1 blade is extended at a time
- Rubber comfort grip minimizes fatigue and reduces slippage
- Knife includes 2 straight and 2 hook blades
- Total blade storage capacity - 11 (9 storage + 2 in use)

SKU#	LENGTH		BOX /CTN
	mm	inches	
10-789	175	6-7/8"	6/24

### Classic 99 Retractable Utility Knife



- Interlocking nose to hold blade securely
- Three-position retractable blade
- Blade storage in handle
- Three blades included inside

SKU#	LENGTH		BOX /CTN
	mm	inches	
10-099	152	6"	6/36

### FatMax® Retractable Utility Knife



**FatMax**

- Adjustable thumb-dial locking wheel holds blade in place and prevents shifting
- Swivels open for quick blade change – no tools required
- Rear blade storage for seven blades
- Ergonomically designed rubber grip fits comfortably in hand
- Lightweight, durable body

SKU#	LENGTH		BOX /CTN
	mm	inches	
10-777	165	6.5"	6/36

### DynaGrip® Retractable Utility Knife



- Reduced heat/cold transfer
- Patented InterLock® nose secures blade
- Grip is non-slip, even with gloved hands, or on an angled surface
- Additional comfort in extreme temperatures
- 3 pcs blade in handle

SKU#	O / A LENGTH		BOX/CTN
	mm	inches	
STHT10779-8	144	5-5/8"	6/36

## 2 CUTTING AND HOLDING TOOLS

### Retractable Utility Knife



- Lightweight, economical utility knife
- Plastic & die cast zinc body shaped for comfort in use
- Multi-position blade slide
- 3 pcs Blade Storage handle

NEW SKU#	SKU#	O / A LENGTH		BOX/CTN
		mm	inches	
10 175	STHT10175-8	156	6-1/8"	6/36

### InterLock® Self-Retracting Utility Knife



- Spring-loaded blade retracts automatically when pressure on slide button is released
- Patented interlocking nose secures blade safely between knife halves

NEW SKU#	SKU#	O / A LENGTH		BOX/CTN
		mm	inches	
10-189C	STHT10189-8	144	5-5/8"	6/36

### Basic Snap-Off Knife



- Lightweight and economical snap-off blade knife
- Works with most light-weight applications
- Tips in use can be removed with the snapper at the end-cap of the knife
- Pocket clip included on the 9mm (10-131) Snap-Off Knife

NEW SKU#	SKU#	DESCRIPTION	BLADE WIDTH	O / A LENGTH		BOX/CTN
				mm	inches	
10-131-S	10-131	9mm snap-off knife	9mm	137	5-3/8"	6/86
10-143-S	10-143	18mm snap-off knife	18mm	152	6"	6/432

### 18mm Standard Snap-Off Knife



- Made with stainless steel and high impact polymer components
- Smooth slider mechanism features an audible "click" and is self-locking for security
- Blade sections snap off to provide fresh, sharp cutting points
- Removable blade snapper included in cap of knife
- Hang hole for storage or lanyard
- High visibility spare blade holder designed for safety

NEW SKU#	SKU#	BLADE WIDTH	O / A LENGTH		BOX/CTN
			mm	inches	
10-280-0-23	10-280-0	18	172	6-3/4"	12/72

### Retractable Blade Knife



- On-Board Blade Storage - Blade holder tank that can hold up to 10 blades. Supplied with 3 free blades
- 5-position blade exposure adjustment button, to control cutting depth
- Instant Change Push Button Blade Change – Improved Convenience
- Bi-Mat Handle – Safety & Comfort

SKU#	DESCRIPTION	BLADE WIDTH	LENGTH	BOX/CTN
STHT10430-0	Retractable Blade Knife	18mm	157	6

1 MEASURING & LAYOUT TOOLS

2 CUTTING & HOLDING TOOLS

3 FASTENING TOOLS

4 STRIKING & STRUCK TOOLS

5 PAINTING & FINISHING TOOLS

6 MECHANIC TOOLS

7 TOOLS STORAGE

## 2 CUTTING AND HOLDING TOOLS



### 18mm DynaGrip® Snap-Off Cartridge Knife



- Blade cartridge automatically slides new blade into position after old blade is removed
- Stainless steel blade dispenser cartridge resists rust
- Ergonomically designed for comfort and cutting power
- Smooth, slider mechanism features audible click stop and is self-locking
- Strong, durable tri-material construction with soft-grip panels
- Hang hole for storage or lanyard
- Blade capacity of six heavy-duty or five extra heavy-duty blades
- Comes with six 11-301 heavy-duty blades (equals 32 points)

NEW SKU#	SKU#	BLADE WIDTH		O / A LENGTH		BOX/CTN
		mm	mm	mm	inches	
0-10-480	10-480	18	Handle 172	6-3/4"	6/36	

### Quick Point Knife



- Light-duty, retractable knife with Quick-Point™ snap-off blades
- Blade sections snap off providing fresh, sharp cutting points
- Removable blade snapper included in cap of knife
- Pocket clip included
- Comes with one blade (equals 13 points)

NEW SKU#	SKU#	BLADE WIDTH		O / A LENGTH		BOX/CTN
		mm	mm	mm	inches	
0-10-150	STHT10150-8	9	130	5-1/8"	6/72	

### Quick Point Knife



- Light-duty, retractable knife with Quick-Point™ snap-off blades
- Blade sections snap off providing fresh, sharp cutting points
- Removable blade snapper included in cap of knife
- Comes with one blade (equals 8 points)

NEW SKU#	SKU#	BLADE WIDTH		O / A LENGTH		BOX/CTN
		mm	mm	mm	inches	
0-10-151	STHT10151-8	18	156	6-1/8"	6/72	

### 18mm SnapOff Knife



- Enables firm and comfortable holding position, also providing excellent grip control
- Automatically holds blade in a fixed position to prevent blades from being pulled out and pushed in
- Hang hole for easy storage

SKU#	Description	Blade Width	Blade Length	Locking	BOX/CTN
		mm	mm	Mechanism	
STHT10276-8	Snap Off Knife	18	204	Auto Slide Lock	20
STHT10321-8	Dial Lock Snap Off Knife	18	204	Screw Dial Lock	20



## 2 CUTTING AND HOLDING TOOLS

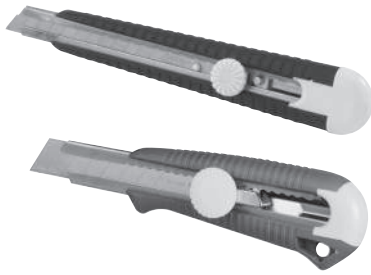

### 9mm & 18mm Knives with DynaGrip®

- Metal and high impact polymer construction for durability
- Blade sections snap-off providing the user with fresh, sharp cutting points
- Removable blade snapper included in cap of knife
- High impact polymer body contains elastomer for great grip and comfort
- Rigid stainless steel barrel provides smooth action and corrosion resistance
- Metal blade slide for positive blade positioning
- Pocket clip included on 10-409 9mm DynaGrip® Snap Off knife
- Supplied with one Quick-Point™ blade

SKU#	BLADE WIDTH	O / A LENGTH		BOX/CTN
	mm	mm	inches	
STHT10409-8	9	130	5-3/8"	12/72
STHT10418-8	18	152	6-1/2"	6/36



### 25mm Snap-Off-Knife with DynaGrip®

- Thumb dial blade release for easy blade change
- 25mm/1" snap-off blades to help resist snapping and adds durability
- 8 segments with 8 sharp tips
- Rubber DynaGrip® Panels for secure, comfortable grip
- Yellow ABS plastic body

SKU#	BLADE WIDTH	HANDLE LENGTH		BOX/CTN
	mm	mm	inches	
STHT10425-8	25	180	7"	6/72



### Sport Utility™ Knife

- Comes with holster, blades dispenser & 10 pcs spare blades "sport" blade
- Retractable utility blade at opposite end allows for convenience when cutting applications change
- Rubber panels provide a comfortable non-slip grip
- Patented interlocking nose prevents knife halves from spreading
- Furnished with one 11-921 heavy-duty utility blade

SKU#	HANDLE LENGTH		BOX/CTN	MOQ
	mm	inches		
10-804	168	6-5/8"	2/6	300



### Double-Sided Pull Cutter

- Completely recessed blade helps reduce risk of injury
- Double-sided recessed blade increases the usefull life of the pull cutter
- Optimized cutting depth cuts through single/double wall corrugate.
- Tape splitter pierces and cuts through tape in one motion
- Lightweight design helps reduce user fatigue
- Lanyard hang hole for easy transportation and storage

SKU#	Description	BOX/CTN
STHT 10359	Double-Sided Pull Cutter (1PK)	40



### Single-Sided Pull Cutter

- Completely recessed blade helps reduce risk of injury
- Hook pleracer pierces and cuts through single/double wall corrugate.
- Tape splitter pierces and cuts through tape in one motion
- Lightweight design helps reduce user fatigue
- Lanyard hang hole for easy transportation and storage

SKU#	Description	BOX/CTN
STHT 10355	Single-Sided Pull Cutter (1PK)	40

## 2 CUTTING AND HOLDING TOOLS

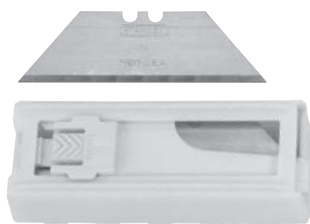

### Classic 1992® Heavy-duty Utility Blade

- Heavy-duty blade, ideal for carpet and vinyl
- Replacement blade for 10-099, 10-175, 10-777, 10-779 & 10-804

SKU#	#OF BLADES	LENGTH mm	BLADE WIDTH		BLADE THICKNESS	BLADES PACK DETAILS	BOX/ CTN
		mm	mm	inches			
11-921H	100	62	19	3/4"	0.65mm	10 Dispensers of 10pcs	1/24
11-921T	10	62	19	3/4"	0.65mm	10pcs per Dispensers	1/72



### Large Hook Blade

- Sharpened hook with point for penetrating and cutting sheet material
- Replacement blade for 10-777, 10-779, 10-099, 10-175 & 10-804

NEW SKU#	SKU#	#OF BLADES	LENGTH mm	BLADE WIDTH		BLADE THICKNESS	BLADES PACK DETAILS	BOX/ CTN
			mm	mm	inches			
0.11.983	11-983-0	5	50	19	3/4"	0.65mm	Card (5)	10/10
1-11-983	11-983-1	100	50	19	3/4"	0.65mm	Box of 100	1/20

BLADE SELECTION GUIDE		BLADE				BOX/ CTN
REPLACEMENT BLADE	SIZE	11-921H	11-921T	11-983-0	11-983-1	
10-099	3/4"	•	•	•	•	6/36
10-175	3/4"	•	•	•	•	6/36
10-777	3/4"	•	•	•	•	6/36
10-779	3/4"	•	•	•	•	6/36
10-804	3/4"	•	•	•	•	2/6



### Quick-Point™ Blade

- Replacement blade for STANLEY 1" or 25mm snap-off knife 11-425

NEW SKU#	SKU#	#OF BLADES	LENGTH mm	BLADE WIDTH		BLADE THICKNESS	BLADES PACK DETAILS	BOX/ CTN
			mm	mm	inches			
0-11-325	STHT11325-8Q	10	110	25	1"	0.9 mm	10 pcs carded dispensers	10/100

## 2 CUTTING AND HOLDING TOOLS

### Quick-Point™ Blade

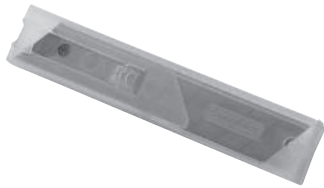

- Replacement blade for 10-380, 10-280, 10-418, 10-151 and other 18mm snap-off knives
- Blade with 8 cutting points

SKU#	#OF BLADES	LENGTH mm	BLADE WIDTH		BLADE THICKNESS	BLADES PACK DETAILS	BOX/CTN
			mm	inches			
11-301T	10	110	18	3/4"	0.55mm	10 pcs dispensers	24/288
11-301H	100	110	18	3/4"	0.55mm	100 blades in dispensers of 10 each	1/27
11-300T	10	110	9	3/8"	0.43mm	10 pcs dispensers	48/576
11-300H	100	110	9	3/8"	0.43mm	100 blades in dispensers of 10 each	48/96

BLADE SELECTION GUIDE		BLADE				BOX/CTN
REPLACEMENT BLADE	SIZE	11-301T	11-301H	11-325-0	11-325-1	
10-151-0	3/4"	•	•			6/72
10-280-0	3/4"	•	•			12/72
10-380-0	3/4"	•	•			6/36
10-418	3/4"	•	•			6/36
11-425	3/4"			•	•	6/72

### Wood Handle Saw



- Machine set and sharpened teeth for accurate cutting
- High carbon steel blade hardened and tempered for sharpness and durability
- Comes with full length sleeve

NEW SKU#	SKU#	CONTENTS	TOOTH PAATERN	BOX/CTN
20-502-23	20-502	18"	Crosscut / 7TPI	12/24
20-503-23	20-503	20"	Crosscut / 7TPI	12/48
20-504-23	20-504	22"	Crosscut / 7TPI	12/24
20-505-23	20-505	24"	Crosscut / 7TPI	12/24

### Thrifty® Backsaw



- Hardened and tempered steel for duravility with contoured, molded handle for comfort

NEW SKU#	SKU#	BLADE SIZE		Tooth Pattern	BOX/CTN
		mm	inches		
15-509-23	15-509	305	14"	12TPI	6/36

1 MEASURING & LAYOUT TOOLS

2 CUTTING & HOLDING TOOLS

3 FASTENING TOOLS

4 STRIKING & STRUCK TOOLS

5 PAINTING & FINISHING TOOLS

6 MECHANIC TOOLS

7 TOOLS STORAGE

## 2 CUTTING AND HOLDING TOOLS



### Plastic Handle Saw



- Handle offers a square/mitre feature with 45° and 90° angles
- Contoured sturdy handle designed for comfort and control
- Full length protective sleeve

NEW SKU#	SKU#	CONTENTS	TOOTH PAATERN	BOX/CTN	
STHT20081-8	20-081	20"	Crosscut / 6TPI	12/48	
STHT20082-8	20-082	22"	Crosscut / 6TPI	12/24	
	20-083-23	24"	Crosscut / 6TPI	12/24	
	N/A	20-004	18"	Crosscut / 7TPI	12/48
	N/A	20-005	20"	Crosscut / 7TPI	12/48
	20-006-23	20-006	22"	Crosscut / 7TPI	12/24
	20-007-23	20-007	24"	Crosscut / 7TPI	12/24
	N/A	20-026	26"	Crosscut / 7TPI	12/24

### Clamping Mitre Box with Saw

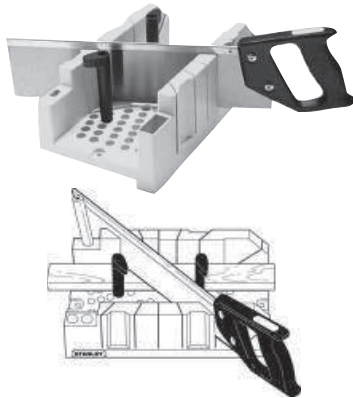

- One piece injection moulded mitre box for strength and durability
- Holds material securely for accurate cuts
- Material secures to the base with a twist of the cam pins
- Cuts miters on 45° and 90° angles, face angle 45° and 22-1/2° angles
- Molded-in storage compartments hold cam pins and pencil
- Molded lip on base edge for easy use without mounting
- Complete with fine tooth built-in backsaw to prevent cutting into miter box
- Holes in base for fastening to workbench with patented cam lock clamping system which holds work piece securely in place.

SKU#	Length	DIMENSIONS IN MM		BOX/CTN
		Max. Height	Max Width	
20-600	300	80	130	6/6

### High-Tension Hacksaw & Metal Mini-Hack™ Utility Saw



- Pack includes 2 hacksaws – ideal for cutting metal & plastic.
- Rugged Design for heavy-duty use.
- Quick Release blade changing mechanism maintains tension setting.
- Mni-Hack is lightweight, comfortable & durable.
- Mini-Hack's handle covers blade to help cover user's hand.

SKU#	DEPTH OF THROAT	HACKSAW	MINI-HACK	BOX/CTN
20-036	102mm (4")	305mm (12")	254mm (10")	8/8

### Bi-Mat Hand Saw



- Bi-Material ergonomic Handle provides anti-slip and enhanced comfort
- Triple Ground Teeth For fast and smooth Cutting
- Ultrasonically welded handle ensuring secure and reliable cutting performance over time

SKU#	DESCRIPTION	BLADE LENGTH	BLADE THICKNESS	TPI/ PPI	BLADE MATERIAL	HABDLE MATERIAL	CUTTING APPLICATIONS	BOX/ CTN
STHT20373-LA	Bi-Material Handsaw 15"	15" (380mm)	0.03" (0.85mm)	8 / 9	High Carbon Steel	ABS+Rubber	Aggressive Cut (All Wood)	6
STHT20374-LA	Bi-Material Handsaw 18"	18" (450mm)	0.03" (0.85mm)	8 / 9	High Carbon Steel	ABS+Rubber	Aggressive Cut (All Wood)	6
STHT20375-LA	Bi-Material Handsaw 20"	20" (500mm)	0.03" (0.85mm)	8 / 9	High Carbon Steel	ABS+Rubber	Aggressive Cut (All Wood)	6
STHT20376-LA	Bi-Material Handsaw 22"	22" (550mm)	0.03" (0.85mm)	8 / 9	High Carbon Steel	ABS+Rubber	Aggressive Cut (All Wood)	6

## 2 CUTTING AND HOLDING TOOLS



### Product Features & Benefits

- **225lbs Blade Tension** for secure blade tension to frame
- **90 and 180 Degree Adjustable Angles** allows for flush cuts
- **Large, Comfortable Tension Knob** for comfort & control
- Robust All Metal Frame for durability

SKU#	DESCRIPTION
STHT20138	BASED HACKSAW FRAM BLADE

### SharpTooth™ Nest-Of-Saw



- 3 versatile interchangeable blades in a comfortable moulded handle
- Perfect for curves, circles and trim work
- Includes a fast-cutting 12" ShortCut® finishing made suitable for cutting moulding, PVC pipe and wood

SKU#	DESCRIPTION	BOX/CTN
15-090	3 Blades - consist of:	6/6

### 4-Way™ Keyhole Saw



- 4-Way™ blade positioning cuts curves circles and frets into places where an ordinary hacksaw cannot reach
- Cuts wood, nails, metal latch, composition board, BX cable, conduit, etc
- Lightweight, pistol grip handle fits hand
- Complete with one wood cutting blade and one metal cutting blade

SKU#	BLADE LENGTH inches	# OF BLADES	BOX/CTN
15-275	1 pcs of Wood & 1 pcs of Metal cutting blade	2	6/6

### Coping Saw



- Hardened, tempered blade provides clean, controlled cutting action
- 4 blades included
- Light weight wooden handle



SKU#	DESCRIPTION	BLADE Length (in)	BLADE Length (mm)	Frame Depth (in)	Frame Depth (mm)	TPI
STHT15104-8	Coping Saw 120mm 4.75" Depth (4 blades)	6-1/2"	165	4-3/4	120	15

1 MEASURING & LAYOUT TOOLS

2 CUTTING & HOLDING TOOLS

3 FASTENING TOOLS

4 STRIKING & SHOCK TOOLS

5 PAINTING & FINISHING TOOLS

6 MECHANICAL TOOLS

7 TOOL STORAGE

## 2 CUTTING AND HOLDING TOOLS



### Junior Hacksaw

- Quick release hacksaw features a lever moulded into grip handle for easy blade change
- Deep throat for good work capacity
- 1 blade free

NEW SKU#	SKU#	OVERALL LENGTH		BLADE LENGTH		BOX/CTN
		mm	inches	mm	inches	
0-15-218	15-218-0	254	10"	150	6	10/60



### Steel Frame Hacksaw

- Positive locking mechanism
- Two blade position 90°/55°
- Aluminium handle - 12" blades

SKU#	LENGTH		BLADE SIZE		BOX/CTN
	mm	inches	mm	inches	
15-166	450	17-3/4"	305	12"	6/36



### Tubular Frame Hacksaw

- Heavy gauge tubular steel frame nickel-plated will not tarnish or rust provides handy holding compartment for extra blades
- Easy adjustment of frame for 10" (255 mm) and 12" (305 mm) blade
- Blade can be faced in four directions
- Rugged cast handle with guard designed to protect knuckles
- Furnished with 10" (255 mm) standard carbon steel blade

SKU#	DEPTH OF THROAT		BLADE LENGTH		BOX/CTN
	mm	inches	mm	inches	
15-408	98	3-7/8"	255 & 305	10" & 12"	2/12



### 12" High Tension Hacksaw

- Rugged design for heavy-duty use
- Fully adjustable tension holds blade up to 32,000 psi – delivers fast, accurate cuts and long blade life
- Blade storage is integrated into frame
- Quick-release, blade-changing mechanism in handle maintains tension setting
- Blade can be positioned at 45° or 90° cutting angle
- Blade Length 12" / 305mm
- Throat Depth 3-7/8" / 98mm

NEW SKU#	SKU#	LENGTH		BLADE SIZE		BOX/CTN
		mm	inches	mm	inches	
15-113-23	15-113	98	3-7/8"	305	12"	2/12

## 2 CUTTING AND HOLDING TOOLS

### 10" & 12" Adjustable Blade Rubber Grip Hacksaw



- Easy adjustment of frame for 10" and 12" blades
- Rigid steel frame with molded cushion grip
- D-shape guard helps protect hands and knuckles
- Blade Length 10" / 254mm or 12" / 305mm
- Throat Depth 3-7/8" / 98mm

NEW SKU#	SKU#	LENGTH		BLADE SIZE		BOX/CTN
		mm	inches	mm	inches	
15-265-S	15-265	98	3-7/8"	254/305	10/12"	6/6

### 10" & 12" Adjustable Blade Hacksaw



- Rugged plated steel frame
- Fits 10" and 12" blades
- Comfort pistol-grip handle
- Blade Length 10" / 254mm or 12" / 305mm
- Throat Depth 2-3/4" / 70mm

NEW SKU#	SKU#	LENGTH		BLADE SIZE		BOX/CTN
		mm	inches	mm	inches	
15-565-S	15-565	70	2-3/4"	254/300	10/12"	6/6

### Mini-Hack™ Saw



- Ergonomically designed grip with thumb rest for maximum comfort
- 35mm cutting capacity
- Back blade stop for safe handling and use

NEW SKU#	SKU#	LENGTH		BLADE SIZE		BOX/CTN
		mm	inches	mm	inches	
STHT20807-8	20-807	220	8-3/4"	254	10"	63/6

### Glass Cutter



- Die cast handle has a wide contoured comfort grip and ball end for tapping
- Steel wheel with general purpose cutting angle delivers precise scoring clean breakout, and smooth edges
- 3 Break-off notches for various depths
- Honed Cutting wheel
- Cuts glass up to 3 mm

SKU#	O / A LENGTH		BOX/CTN
	mm	inches	
14-125	130	5-1/8"	24/288

## 2 CUTTING AND HOLDING TOOLS

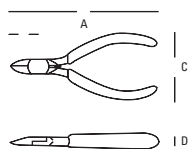

### Precision Pliers

- 2 times longer cutting life 25% less cutting effort
- Cutting edge are precision ground & pre-finished before assembly for consistent performance
- Full collar, anti-slip ergonomic handle for comfort & superior gripping
- Machined teeth for maximum gripping in tight spaces
- Made of strong chrome vanadium material for longer lasting cutting
- Maximum anti-rust capability

SKU#	DESCRIPTION	A (mm)	B (mm)	C (mm)	D (mm)	BOX/CTN
84-036	100mm/4" Precision Nipper Cutter	115	23.8	48	8	6/36

### FatMax® VDE Pliers

- Safe live line working to 1,000v
- Individually tested to 10,000v
- Compliant to EN60900, IEC/CEI900, VDE688
- Bi-material handle with secure grip grooving for comfort
- Heat treated high chrome steel forging for long life and durability
- Hand ground, induction hardened blade for long life and accuracy
- Finger guard for better control & added user safety
- Interlocking joint assembly for smooth cutting
- DIN/ ASO/ ANSI Compliant



SKU#	LENGTH DESCRIPTION	BOX/CTN
84-000	160mm/6" Combination (2101NV)	4/24
84-001	180mm/7" Combination (2201NV)	4/24
84-002	200mm/8" Combination (2301NV)	4/24

SKU#	LENGTH DESCRIPTION	BOX/CTN
84-004	200mm/8" Diagonal Pliers (2032NV)	4/24

SKU#	LENGTH DESCRIPTION	BOX/CTN
84-006	180mm/7" Long Nose Pliers (2021NV)	4/24
84-007	200mm/8" Long Nose Pliers (2023NV)	4/24

SKU#	LENGTH DESCRIPTION	BOX/CTN	MOQ
84-008	200mm/8" Bent Nose Pliers (2023NBV)	4/24	504

SKU#	LENGTH DESCRIPTION	BOX/CTN
84-009	160mm/6-1/4" Narrow Head Diagonal Pliers	4/24

SKU#	LENGTH DESCRIPTION	BOX/CTN
84-011	3pcs Pliers Sets (84-001, 84-007 & 84-009)	4/4

SKU#	LENGTH DESCRIPTION	BOX/CTN
84-294	250mm/10" Water Pump Pliers (AA-01V)	4/24



### DYNAGRIP PLIERS

#### Linesman Pliers



- Gripping combined with cutting, known as side cutting pliers.
- Made popular by electricians
- Used for cutting as well as bending and twisting wire and as fish tape puller

NEW SKU#	SKU#	DESCRIPTION	LENGTH inches	BOX/CTN
STHT84623-8	84-623-2	6" HD combination plier - carbon steel, polished	6"	6/36
N/A	STHT84035-8	7" Linesman plier - carbon steel, polished	7"	6/36
N/A	STHT84029-8	8" Linesman plier - carbon steel, polished	8"	6/36
STHT84609-8	84-609-2	9" Linesman plier - carbon steel, polished	9"	6/36

#### Diagonal Pliers



- The cutting jaws are at an angle to the handles, allowing the user to cut close to a surface with the hand clear of obstructions. Also used for wire stripping

NEW SKU#	SKU#	DESCRIPTION	LENGTH inches	BOX/CTN
N/A	STHT84027-8	6" Diagonal cutting plier - carbon steel, polished	6"	6/36
N/A	STHT84028-8	7.5" HD diagonal plier - carbon steel, polished	7.5"	6/36
STHT84607-8	84-607-2	8" Diagonal plier - carbon steel, polished	8"	6/36

#### Groove Joint Pliers



- Originally designed for work on plumbing fittings, with serrated curved jaws to grip round objects

NEW SKU#	SKU#	DESCRIPTION	LENGTH inches	BOX/CTN
STHT84034-8	84-034-2	8" Groove joint plier - carbon steel, polished	8"	6/36
STHT84024-8	84-024-2	10" Groove joint plier - carbon steel, polished	10"	6/36
STHT84021-8	84-021-2	12" Groove joint plier - carbon steel, polished	12"	6/36

## 2 CUTTING AND HOLDING TOOLS



### End Cutter Plier



- Used for cutting wire, cutting edge is at 90° to the handle, to allow close cropping of wire and is commonly used for tile cutting

NEW SKU#	SKU#	DESCRIPTION	LENGTH inches	BOX/CTN
STHT84077-8	84-077-2	6" End nipper plier - carbon steel, polished	6"	6/36
STHT84167-8	84-167-2	8" End nipper plier - carbon steel, polished	8"	6/36

### Wire Strippers



- Carbon Steel hardened cutting edges and jaws
- Heavy-duty steel riveted joints
- Dyna grip handles for maximum comfort
- Hard chrome finish with anti-corrosion surface

NEW SKU#	SKU#	DESCRIPTION	LENGTH inches	BOX/CTN
STHT84075-8	84-075-2	6" Wire stripper - carbon steel, polished	6"	6/36

### Bent Nose Pliers



- The angled nose is capable of gripping and manouvering objects in obstructed situations

NEW SKU#	SKU#	DESCRIPTION	LENGTH inches	BOX/CTN
N/A	STHT84071-8	6" Bent nose plier - carbon steel, polished	6"	6/36
STHT84072-8	84-072-2	8" Bent nose plier - carbon steel, polished	8"	6/36

### Long Nose Pliers



- Smooth tapering jaws are capable of gripping and manouvering
- Wire in confined areas. Also used to bend, loop and cut wire

SKU#	DESCRIPTION	LENGTH inches	BOX/CTN
STHT84031-8	6" Long nose plier - carbon steel, polished	6"	6/36
STHT84032-8	8" Pliers HD long nose - carbon steel, polished	8"	6/36

## 2 CUTTING AND HOLDING TOOLS

### Slip Joint Pliers



- Provide reliable and sturdy grasping and prying ability
- Forged, chrome carbon steel construction meets or exceeds ANSI standards
- Rust-resistant finish, hardened edges for strength, and machined jaws for slip-resistant grip
- Double-dipped handles provide comfortable use

SKU#	DESCRIPTION	LENGTH inches	BOX/ CTN
STHT84055-8	6" Slip joint plier - carbon steel, chrome plated	6"	6/36
STHT84026-8	8" Slip joint plier - carbon steel, chrome plated	8"	6/36

### Flat Nose Pliers



- With serrated, tapering jaws allowing manoeuvrability of small flat objects

NEW SKU#	SKU#	DESCRIPTION	LENGTH inches	BOX/ CTN
STHT84073-8	84-073-2	6" Flat nose plier - carbon steel, polished	6"	6/36

### Miniature Pliers



- Small sized for precision work
- Chrome nickel for durability
- Double dip handles for comfort

NEW SKU#	SKU#	DESCRIPTION	LENGTH		BOX/CTN
			mm	inches	
STHT84119-8	84-119	Long Nose Pliers	127	5"	6/36
STHT84124-8	84-124	Diagonal Cutting Pliers	102	4"	6/36
STHT84096-8	84-096	Needle Nose Pliers	127	5"	6/36

NEW SKU#	SKU#	DESCRIPTION	LENGTH		BOX/CTN
			mm	inches	
STHT84126-8	84-126	Bent Nose Pliers	127	5"	6/36
STHT84122-8	84-122	Flat Nose Pliers	102	4"	6/36

1 MEASURING & LAYOUT TOOLS

2 CUTTING & HOLDING TOOLS

3 FASTENING TOOLS

4 STRIKING & STRUCK TOOLS

5 PAINTING & FINISHING TOOLS

6 MECHANIC TOOLS

7 TOOLS STORAGE

## 2 CUTTING AND HOLDING TOOLS



### MaxSteel™ Aviation Snips

- Excellent for cutting aluminium, vinyl siding, screening, cardboard, leather & copper
- Exceeds ANSI standards for cutting performance and durability
- Double overwind spring for longer life
- High leverage, compound cutting design cuts up to 18-Gauge steel
- Patented hinge plate for easy product function identification

NEW SKU#	SKU#	LENGTH		CUT TYPE	CUTTING LENGTH	COPPER (SOFT)	CUTTING CAPACITY (mm)				BOX/CTN
		mm	inches				COLD-ROLLED STEEL (MILD)	HARD STEEL HRC30 (HARD)	HARD STEEL HRC40 (HARD)	STAIN-LESS STEEL 304	
14-562-22	14-562	254	10"	Left Curve	35	1.50	1.20	1.00	0.60	0.90	6/24
14-563-22	14-563	254	10"	Straight Cut	35	1.50	1.20	1.00	0.60	0.90	6/24
14-564-22	14-564	254	10"	Right Curve	35	1.50	1.20	1.00	0.60	0.90	6/24

### MaxSteel™ All Purpose Snips (Straight Pattern)



- Exceeds ANSI Standards for cutting performance & durability
- Tough alloy steel blade
- Comfortable vinyl grips
- Cuts up to 0.78mm of cold rolled steel and 0.46mm of stainless steel

NEW SKU#	SKU#	O / A LENGTH		CUTTING CAPACITIES (MM)			BOX/CTN
		mm	inches	COPPER (SOFT)	COLD-ROLLED STEEL (MILD)	HARD STEEL HRC30 (HARD)	
14-569-22	14-569	178	7"	0.94	0.56	0.38	6/24
14-556-22	14-556	254	10"	0.94	0.78	0.6	6/24
14-558-22	14-558	305	12"	1.15	0.91	0.7	6/24

### Tinsnips



- Drop-forged carbon steel material, hardened, tempered, grown, glazed & tested to last

SKU#	CUTTING CAPACITY		SIZE	BOX/CTN
	Cold-rolled Steel	Stainless Steel		
14-163	0.61	0.41	8"	6/36
14-164	0.78	0.45	10"	6/36
14-165	0.91	0.63	12"	6/24
14-166	1.20	0.70	14"	6/24

## 2 CUTTING AND HOLDING TOOLS

### Bolt Cutter



- A range of bolt cutters in most popular sizes
- Cutter blades are of chrome molybdenum tempered steel with cutting jaws tempered HRC 60° (FBS std)
- Special heat treatment give blades extra hardness and durability

NEW SKU#	SKU#	LENGTH		MAX CUTTING LOAD	
		mm	inches	(kg)	BOX/CTN
14-308-S	14-308	203	8"	36	6/48
14-312-S	14-312	305	12"	46	6/24
14-314-S	14-314	355	14"	54	6/24
14-318-S	14-318	457	18"	65	6/12
14-324-S	14-324	609	24"	61	2/6
14-330-S	14-330	762	30"	84	1/4
14-336-S	14-336	914	36"	104	1/4

### Pruning Shears



- Blades of precision steel
- Cuts up to 18mm / 3/4" thickness
- Padded handle for comfort and reduced hand fatigue
- Safety lock feature

NEW SKU#	SKU#	O/A LENGTH		TYPE	BOX/CTN
		mm	inches		
14-302-23	14-302	200	8"	Bypass	10/60
14-303-23	14-303	200	8"	Anvil	10/60

### STANLEY® Hedge Shear

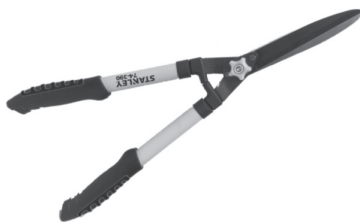

- Lower blade middle carbon steel
- Aluminium handles with soft grip
- Tension adjustment
- Length 60 cm

SKU#	CONTENTS	BOX/CTN
STHT74995-8	Hedge Shear 8"	6/12

## 2 CUTTING AND HOLDING TOOLS

### Locking Pliers



- Serrated jaws made of chrome molybdenum material
- Heat-treated adjustable screw
- Long straight nose provides easy access in narrow, hard to reach places
- Ideal for precision work
- Curved jaws puts tremendous pressure on 4 points at any style or bolt head
- Straight jaws provides maximum contact on flat, square & hex work - ideal for welding & other metal work

NEW SKU#	SKU#	CONTENTS	LENGTH		BOX/CTN
			mm	inches	
84-367-1-S	84-367-1	Curved Jaw	127	5"	6/48
84-368-1-S	84-368-1	Curved Jaw	175	7"	6/36
84-370-1-S	84-370-1	Straight Jaw	175	7"	6/36
84-396-S	84-396	Long Jaw	165	6.5"	6/48

### Combination Snap Ring Pliers



- Internal- External positioning 45°- 90°-180°
- 10-50mm range

NEW SKU#	SKU#	LENGTH		BOX/CTN
		mm	inches	
84-168-22	84-168	152	6"	20/60

### Locking Pliers with Bi-Material Handle

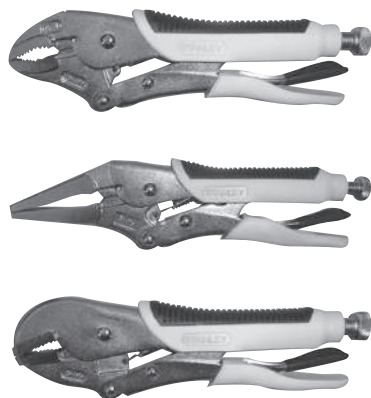

- Bi-material handle for anti-slip & comfort
- Serrated jaws made of chrome molybdenum material
- Heat treated adjustable screw
- Long straight nose provides easy access in narrow, hard to reach places
- Ideal for precision work
- Curved jaws puts tremendous pressure on four points at any style or bolt head
- Straight jaws provides maximum contact on flat, square & hex work - ideal for welding & other metal work

NEW SKU#	SKU#	CONTENTS	LENGTH		BOX/CTN
			mm	inches	
84-369-1-S	84-369-1	Curved Jaw	254	10"	6/36
84-371-1-S	84-371-1	Straight Jaw	254	10"	6/36
84-389-S	84-389	Long Nose	229	9.5"	6/36

### Circlip Pliers



- Tempered alloy steel for strength and durability
- Rust resistant protective finish

NEW SKU#	SKU#	CONTENTS	BLADE LENGTH		BOX/CTN
			mm	inches	
84-271-S	84-271	Straight ext.	175	7"	12/120
84-273-S	84-273	Straight int.	175	7"	12/120
84-272-S	84-272	Bent ext.	175	7"	12/120
84-274-S	84-274	Bent int.	175	7"	12/120

## 2 CUTTING AND HOLDING TOOLS

### Crimping Pliers



- Cuts electrical wires, strips insulation, shears screws and bolts clean (Warning: Grips do not protect against electrical shock.)

NEW SKU#	SKU#	O / A LENGTH		BOX/CTN
		mm	inches	
84-223-22	84-223 (Plier)	230	9"	10/100
84-253-22	84-253 (Set)	230	9"	6/36

### Wire Stripper/Crimper AWG Standard



- Cuts electrical wires, strips insulation, shears screws and bolts clean (Warning: Grips do not protect against electrical shock.)
- Professional peeled, cut line ideal tool.
- can be used in the pressure line and a curved line.
- Laser etched scale - easy to see
- AWG (American Wire Gauge) is a distinction between the standard of the diameter of the wire; the larger the value, the smaller the diameter of the wire.

NEW SKU#	SKU#	Diameter (US Regulations)	Specifications (")	O / A LENGTH		BOX/CTN
				Length (mm)	Diameter (mm)	
84-475-22	84-475	AWG12-22	6	168	2.6 --- 0.6	10/100

### Wire Stripper



- Convenient hole for looping or bending wire
- Ideal for cutting, stripping speaker wire & appliance cords
- Slide adjust for various gauge wire

NEW SKU#	SKU#	O / A LENGTH		BOX/CTN
		mm	inches	
84-214-22	84-214	130	5-1/4"	15/150

### Water Pump Pliers



- Slim water pump pliers
- For use on pipes and nuts

NEW SKU#	SKU#	O / A LENGTH		BOX/CTN
		mm	inches	
STMT84015	84-015	254	10"	12/72

1 MEASURING & LAYOUT TOOLS

2 CUTTING & HOLDING TOOLS

3 FASTENING TOOLS

4 STRIKING & STRUCK TOOLS

5 PAINTING & FINISHING TOOLS

6 MECHANIC TOOLS

7 TOOLS STORAGE

## 2 CUTTING AND HOLDING TOOLS



### Tower Pincer



- Forged from high alloy steel with precision broached jaws & cutting edge

NEW SKU#	SKU#	DESCRIPTION	BOX/CTN
84-281-5	84-281	200mm Tower Pincer	6/36
84-282-23	84-282	250mm Tower Pincer	6/36
N/A	84-288	200mm HD Pincer	6/36

### MaxSteel® Adjustable Wrench



- Bi-material cushion grip for comfort
- Use for plumbing, automotive or home use
- Precision machined face with etched measurement scale in English and Metric
- Strong chrome vanadium steel exceed ANSI specifications
- Slip-resistant bi-material cushion grip
- Rust-resistant phosphate coating
- Handy hang/storage hole in handle

NEW SKU#	SKU#	LENGTH		BOX/CTN
		mm	inches	
90-947-22	90-947	153	6"	2/12
90-948-22	90-948	203	8"	2/12
90-949-22	90-949	250	10"	2/12
90-950-22	90-950	305	12"	2/12

### Adjustable Wrench



- Jaws fully hardened and tempered
- 25% more torque
- For holding on fastening nuts and bolts
- Rust resistant finish

NEW SKU#	SKU#	LENGTH		BOX/CTN
		mm	inches	
87-430-1-5	87-430-1	100	4"	6/120
STMT87431-8	87-431-1	150	6"	6/120
STMT87432-8	87-432-1	200	8"	6/60
STMT87433-8	87-433-1	250	10"	6/60
STMT87434-8	87-434-1	300	12"	6/24
STMT87435-8	87-435-1	375	15"	4/24
87-371-1-5	87-371-1	457	18"	2/12



## 2 CUTTING AND HOLDING TOOLS

### Adjustable Wrench



- Comfortable & anti-slip grip
- For holding on fastening nuts and bolts
- Jaws fully hardened and tempered
- 25% more torque
- Rust resistant finish

NEW SKU#	SKU#	LENGTH		BOX/CTN
		mm	inches	
87-796-S	87-796	460	18"	1/12
97-797-S	97-797	609	24"	1/6

### Pipe Wrench



- Two-way toothing and spring loaded jaw provide positive grip
- Cast iron handle with drop forged jaw, heat-treated
- Knurled large carbon steel nut

NEW SKU#	SKU#	LENGTH		MAX JAW OPENING		WEIGHT (kg)	PERFORMANCE UNDER STANDARD TORQUE		BOX/CTN
		mm	inches	mm	inches				
87-620-S	87-620	140	6"	25	0.98"	0.225	169N.M	6/72	
87-621-S	87-621	186	8"	34	1.33"	0.38	373N.M	6/36	
87-622-S	87-622	248	10"	45	1.77"	0.81	790N.M	6/24	
87-623-S	87-623	297	12"	55	2.16"	1.14	1129N.M	6/12	
87-624-S	87-624	332	14"	65	2.55"	1.4	1468N.M	6/12	
87-625-S	87-625	414	18"	80	3.14"	2.38	2258N.M	2/8	
87-626-S	87-626	553	24"	95	3.74"	3.83	3161N.M	1/4	
87-627-S	87-627	805	36"	140	5.51"	7.88	5137N.M	1/2	

### Aluminum Pipe Wrench



- Offer same durability and ease-of-use found in all STANLEY heavy-duty wrenches
- Min 40% lighter than heavy-duty wrenches
- Easier to maneuver
- Heat-treated steel jaws to ensure maximum durability

NEW SKU#	SKU#	DESCRIPTION	inches	BOX/CTN
84-451-S	84-451	10" Aluminum Pipe Wrench	10"	6/36
84-463-S	84-453	12" Aluminum Pipe Wrench	12"	6/24
84-465-S	84-455	14" Aluminum Pipe Wrench	14"	6/24
84-466-S	84-456	18" Aluminum Pipe Wrench	18"	2/12
84-467-S	84-457	24" Aluminum Pipe Wrench	24"	2/6

### Basin Wrench



- Alloy steel, spring loaded head flops over for loosening and tightening at different angles

NEW SKU#	SKU#	LENGTH		CAPACITY		BOX/CTN
		mm	inches	mm	inches	
87-448-22	87-448	254	10"	22	7/8"	10/40

## 2 CUTTING AND HOLDING TOOLS



### Cable Cutter

- Designed for electric cable, copper, aluminum, etc
- Notched jaw holds & cuts cables in a clean & sharp way



NEW SKU#	SKU#	TYPE	LENGTH inches	MAX CUTTING (mm <sup>2</sup> )	BOX/CTN
84-258-S	84-258	10" Cable Cutter	10"	60	6/36
84-629-22	84-629	12" Cable Cutter	12"	125	6/24
84-630-22	84-630	21" Cable Cutter	21"	250	1/10
84-632-22	84-632	32" Cable Cutter	32"	500	1/5

### PVC Pipe Cutter



- Heavy-duty PVC Pipe Cutter
- Stainless steel blades
- Heat-treated for durability

NEW SKU#	SKU#	O / A LENGTH		BOX/CTN
		mm	inches	
14-442-22	14-442	42	1-5/8"	10/40

### Tubing Cutter

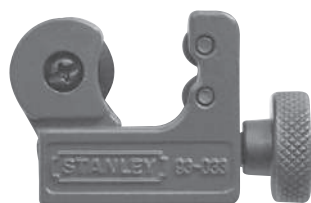

- Tubing cutters for cutting copper/plastic tubing

NEW SKU#	SKU#	O / A LENGTH		BOX/CTN
		mm	inches	
93-033-22	93-033	3-16	1/8" - 3/4"	20/200
93-020-22	93-020	3-28	1/8" - 1-1/8"	10/60
93-021-22	93-021	3-31	1/8" - 1-1/4"	10/60
93-028-22	93-028	3-64	1/8" - 2-1/2"	6/36

### Flaring Tool

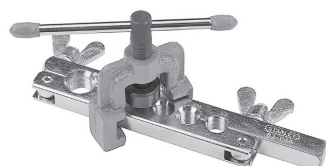

- To flare ends of tubing from 3/16 to 3/4
- Multiple hole 45° aluminium V-block with casted flaring yoke

NEW SKU#	SKU#	CAPACITY UP TO		BOX/CTN
		mm	inches	
93-040-22	93-040	-	3/16 - 5/8	6/24

### Replacement Cutting Wheel



- Hardened alloy steel replacement cutting wheels

NEW SKU#	SKU#	CONTENTS	COMPATIBLE TO-	BOX/CTN
93-019-1-22	93-019-1	Bulk - 10 pcs/card	93-020/021	25/250

## 2 CUTTING AND HOLDING TOOLS

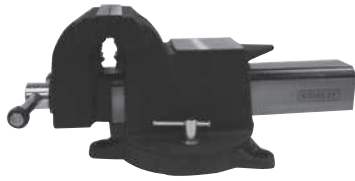

### Cast Steel Bench Vise

- Better Performance
- Better than Iron
- Lightweight compared to Iron

NEW SKU#	SKU#	DESCRIPTION	SIZE	JAW WIDTH/ MAX OPENING	THROAT DEPTH	N.W. (Kg)	CLAMP FORCE (Kg)	BOX/ CTN
81-600-1-22	81-600-1	Bench Vise w/ Base	3"	3"/3"	2"	6kgs	1,500kgs	1/1
81-601-1-22	81-601-1	Bench Vise w/ Base	4"	4"/4"	2-1/4"	7.5kgs	2,500kgs	1/1
81-602-1-22	81-602-1	Bench Vise w/ Base	5"	5"/5"	2-5/8"	11kgs	3,000kgs	1/1
81-603-1-22	81-603-1	Bench Vise w/ Base	6"	6"/6"	3"	14.5kgs	3,500kgs	1/1
81-604-1-22	81-604-1	Bench Vise w/ Base	8"	8"/8"	3-1/2"	20.5kgs	4,500kgs	1/1



### Bit Braces

- Holds shank bit from 1/8" to 7/16"
- Steel clad ball bearing head
- Chrome plated finish for rust resistance
- Available in 10" and 12" sweep

NEW SKU#	SKU#	O / A LENGTH		CHUCK SIZE		BOX/CTN
		mm	inches	mm	inches	
02-110-22	02-110	255	10'	13	1/2"	6/24
02-112-22	02-112	305	12'	13	1/2"	6/24
02-130-22	02-130	255	10'	16	5/8"	6/24



### Hand Drill

- Ideal for rapid drilling of small holes in both wood and metal as well as countersinking screw heads
- Self centering 3-jaw steel chuck with 1/4" and 5/16" capacity
- Double pinion gears for smooth operation

NEW SKU#	SKU#	O / A LENGTH		CHUCK SIZE		BOX/CTN
		mm	inches	mm	inches	
03-011-22	03-011	305	12'	6	1/4"	6/36

# 3 FASTENING TOOLS

## LONG REACH, COMFORTABLE AND SECURE

STANLEY® is one of the world's preeminent manufacturers of fastening tools which are indispensable, must-own line of tools in every professional toolbox. This broad category includes four distinct and distinguished tool lines: staplers (manual and electric), hammer tackers, hand "pop" riveters and electric glue guns. There are nearly 2 dozen fastening tools, so if you've got something to fasten down or hold together, STANLEY® has the tool to get the job done right.

Comfort, quality and versatility are the three attributes we engineer into our screwdriver line. STANLEY® screwdriver handles are shaped and sized to provide comfort in the hand and torque at the fastener head. The materials and construction are of the highest quality to resist corrosion, chipping and breaking. And with tips ranging from standard to Phillips® to Torx® to square, STANLEY® screwdrivers cover almost every application.

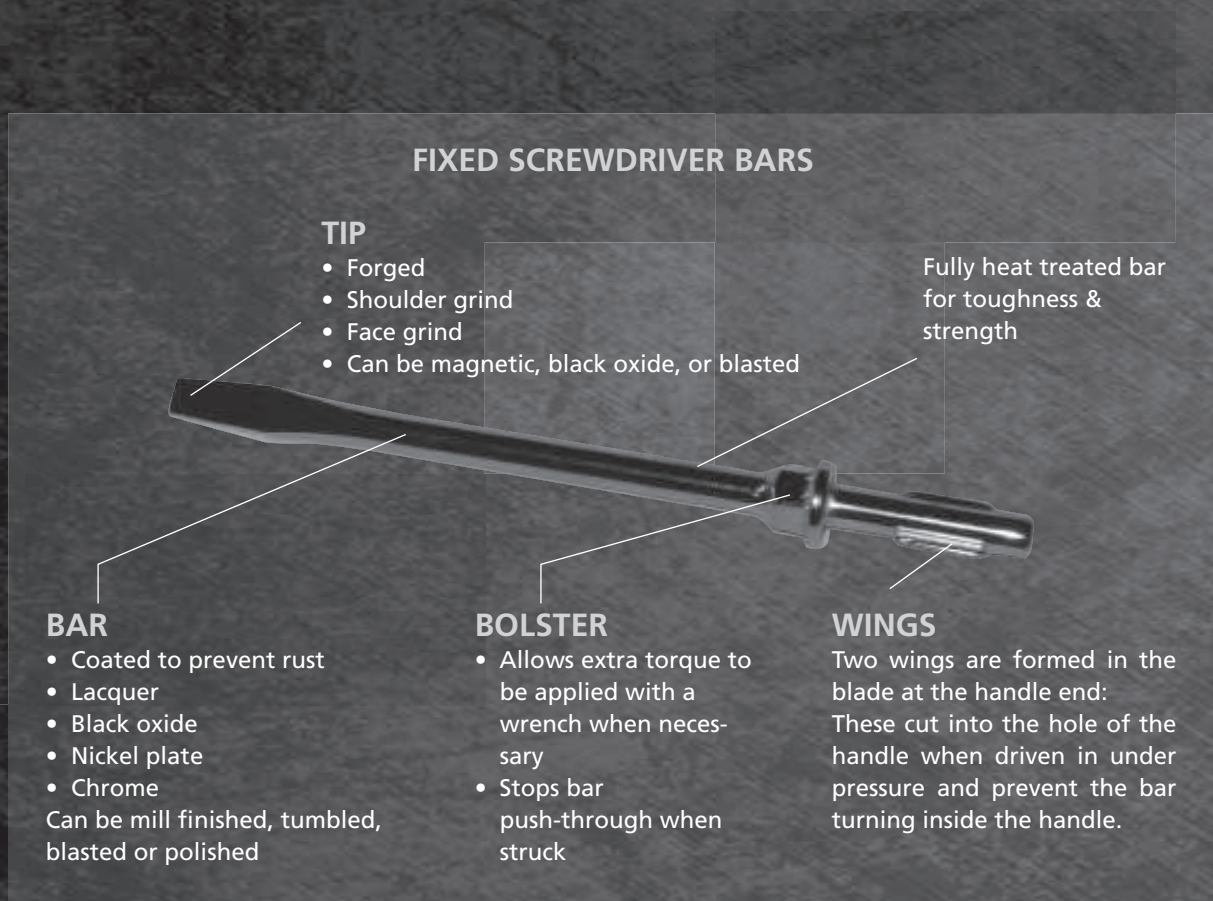

Phillips® is a registered trademark of Phillips Screw Company  
Torx® is a registered trademark of Acument Intellectual Properties, LLC

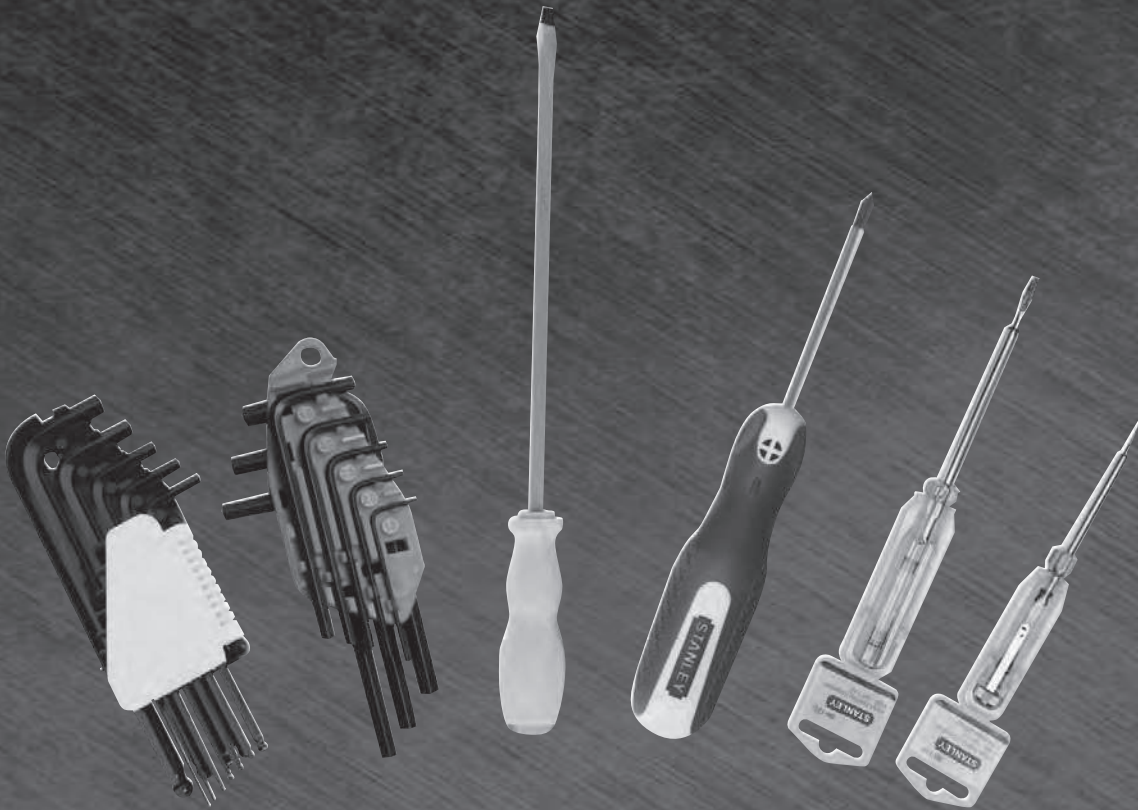

## SCREWDRIVER HANDLES

Handle materials impervious to chemicals

Shape/texturing for grip and mechanical advantage



Tip identification

Small diameter for speed turning

## TIP DIFFERENCES

### SLOTTED TIP DIFFERENCES



**SLOTTED** Screwdrivers are referred to by their Blade Length and Tip Configuration



**Flared Tip :**  
The strongest,  
for heavy-duty

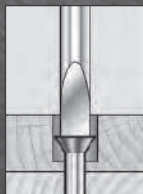

**Cabinet Tip :**  
Used when  
fitting into  
counter bore

### PHILLIPS & POZIDRIV



Referred to by a Number Point  
smallest = 0 point to largest = 4 point

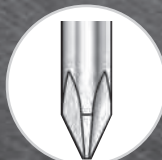

**PHILLIPS**  
Screws have 4 recessed cross 'slots' tapered conically.

Driver Tip has 4 tapered wings separated by 4 hollow flutes.

**POZIDRIV** (common in Europe)

Screws have 4 recessed parallel cross 'slots' and, also, a square recess at the centre.

Driver Tip has 4 straight parallel wings and between each wing is a square-section rib to fit the screw centre.

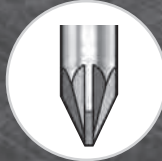



#### Cushion Grip 2 Screwdriver

- Improved ergonomic design for maximum grip and torque
- Ergonomically designed, bi-material handles for maximum comfort and for greater torque to be applied with less effort
- Chrome vanadium blade with tough hardened black oxide tips
- Nickel-plated bar for corrosion resistance
- High quality, heat treated plated bars for lasting "pro" performance and rust resistance



NEW SKU#	SKU#	TYPE	LENGTH		BOX/CTN
			mm	inches	
STMT60800-8	65-157-2	Phillips®	#0 x 75	1/8" x 3" x 0PT	12/72
STMT60801-8	65-158-2	Phillips®	#0 x 100	1/8" x 4" x 0PT	12/72
STMT60802-8	65-159-2	Phillips®	#0 x 125	1/8" x 5" x 0PT	12/72
STMT60803-8	65-160-2	Phillips®	#0 x 150	1/8" x 6" x 0PT	12/72
STMT60804-8	65-162-2	Phillips®	#1 x 75	3/16" x 3" x 1PT	12/72
STMT60805-8	65-163-2	Phillips®	#1 x 100	3/16" x 4" x 1PT	12/72
STMT60806-8	65-164-2	Phillips®	#1 x 150	3/16" x 6" x 1PT	12/72
STMT60807-8	65-165-2	Phillips®	#1 x 200	3/16" x 8" x 1PT	12/72
STMT60808-8	65-166-2	Phillips®	#2 x 45	1/4" x 1-3/4" x 2PT	12/72
STMT60809-8	65-167-2	Phillips®	#2 x 100	1/4" x 4" x 2PT	12/72
STMT60810-8	65-168-2	Phillips®	#2 x 125	1/4" x 5" x 2PT	12/72
STMT60811-8	65-169-2	Phillips®	#2 x 150	1/4" x 6" x 2PT	12/72
STMT60812-8	65-170-2	Phillips®	#2 x 200	1/4" x 8" x 2PT	12/72
STMT60813-8	65-171-2	Phillips®	#2 x 250	1/4" x 10" x 2PT	12/72
STMT60814-8	65-172-2	Phillips®	#3 x 150	5/16" x 6" x 3PT	12/72
STMT60815-8	65-173-2	Phillips®	#3 x 200	5/16" x 8" x 3PT	12/72
STMT60816-8	65-174-2	Phillips®	#3 x 250	5/16" x 10" x 3PT	12/72



NEW SKU#	SKU#	TYPE	LENGTH		BOX/CTN
			mm	inches	
STMT60817-8	65-180-2	Slotted	3 x 75	1/8" x 3"	12/72
STMT60818-8	65-181-2	Slotted	3 x 100	1/8" x 4"	12/72
STMT60819-8	65-182-2	Slotted	3 x 125	1/8" x 5"	12/72
STMT60820-8	65-183-2	Slotted	3 x 150	1/8" x 6"	12/72
STMT60821-8	65-186-2	Slotted	5 x 75	3/16" x 3"	12/72
STMT60822-8	65-187-2	Slotted	5 x 100	3/16" x 4"	12/72
STMT60823-8	65-188-2	Slotted	5 x 150	3/16" x 6"	12/72
STMT60824-8	65-189-2	Slotted	5 x 200	3/16" x 8"	12/72
STMT60825-8	65-190-2	Slotted	6 x 45	1/4" x 1-3/4"	12/72
STMT60826-8	65-191-2	Slotted	6 x 100	1/4" x 4"	12/72
STMT60827-8	65-192-2	Slotted	6 x 125	1/4" x 5"	12/72
STMT60828-8	65-193-2	Slotted	6 x 150	1/4" x 6"	12/72
STMT60829-8	65-194-2	Slotted	6 x 200	1/4" x 8"	12/72
STMT60830-8	65-195-2	Slotted	6 x 250	1/4" x 10"	12/72
STMT60831-8	65-196-2	Slotted	8 x 150	5/16" x 6"	12/72
STMT60832-8	65-197-2	Slotted	8 x 200	5/16" x 8"	12/72
STMT60833-8	65-198-2	Slotted	8 x 250	5/16" x 10"	12/72



NEW SKU#	SKU#	TYPE	LENGTH		BOX/CTN
			mm	inches	
STMT60834-8	65-227-2	Standard	5 x 100	3/16" x 4"	12/72
STMT60835-8	65-228-2	Standard	5 x 150	3/16" x 6"	12/72
STMT60836-8	65-229-2	Standard	5 x 200	3/16" x 8"	12/72

### 3 FASTENING TOOLS



NEW SKU#	SKU#	TYPE	SIZE	LENGTH inches	mm	BOX/ CTN
STMT60837-8	65-1442	Torx®	T5 x 80mm	(1/8" x 3-1/8")	1.37	12/72
STMT60838-8	65-1452	Torx®	T6 x 80mm	(1/8" x 3-1/8")	1.65	12/72
STMT60839-8	65-1462	Torx®	T7 x 80mm	(1/8" x 3-1/8")	1.97	12/72
STMT60841-8	65-1472	Torx®	T8 x 80mm	(1/8" x 3-1/8")	2.30	12/72
STMT60844-8	65-1482	Torx®	T10 x 80mm	(1/8" x 3-1/8")	2.72	12/72
STMT60845-8	65-1492	Torx®	T15 x 80mm	(3/16" x 3-1/8")	3.26	12/72
STMT60847-8	65-1502	Torx®	T20 x 120mm	(3/16" x 4-3/4")	3.26	12/72
STMT60848-8	65-1512	Torx®	T25 x 120mm	(1/4" x 4-3/4")	4.40	12/72
STMT60849-8	65-1522	Torx®	T27 x 120mm	(1/4" x 4-3/4")	4.96	12/72
STMT60850-8	65-1532	Torx®	T30 x 120mm	(1/4" x 4-3/4")	5.49	12/72
STMT60851-8	65-1542	Torx®	T40 x 120mm	(5/16" x 4-3/4")	6.60	12/72

SKU#	CONTENTS	SIZE	BOX/CTN
65-155-2	Torx® Set 5 pcs	T5, T6, T8, T10, T15 x 80mm	12/12

### Cushion Grip 2 Screwdriver Set



NEW SKU#	SKU#	CONTENTS	BOX/CTN
STMT66673	92-004-2	8 pc set: Phillips #0 x 60mm Phillips #1 x 100mm Phillips #2 x 45mm Phillips #2 x 150mm Slotted 3mm x 75mm Slotted 5mm x 100mm Slotted 6mm x 45mm Slotted 6mm x 150mm	12/12
STMT66679	92-002-2	6 pc set with bonus: Phillips #1 x 100mm Phillips #2 x 100mm Phillips #2 x 45mm Slotted 5mm x 100mm Slotted 6mm x 100mm Slotted 6mm x 45mm Free: Digital Test Pen (AN-100)	12/12
STMT66672	65-242-2	6 pc set: Phillips #1 x 100mm Phillips #2 x 150mm Std Parallel 5mm x 100mm Std Parallel 5mm x 150mm Slotted 6mm x 150mm Slotted 5mm x 100mm	12/12
STMT66671	65-199-2	4 pc set: Phillips #1 x 100mm Phillips #2 x 150mm Std Parallel 5mm x 100mm Slotted 6mm x 150mm	24/24
STMT66670	65-200-2	2 pc set: Phillips #2 x 100mm Slotted 6mm x 100mm	24/24



### VDE Screwdriver Set (7pcs)

SKU#	CONTENT	BOX/CTN
STMT60175	7pc set: VDE Screwdriver Standard Parallel - 3 x 75mm VDE Screwdriver Standard Parallel - 4 x 100mm VDE Screwdriver Standard Parallel - 5.5 x 125mm VDE Screwdriver Standard Parallel - 6.5 x 150mm VDE Screwdriver Philips® - #1 x 80mm VDE Screwdriver Philips® - #2 x 100mm Tester - 3.0 x 70mm	10/10

### 3 FASTENING TOOLS



#### 6 Way Screwdriver™



- All-in-one screwdriver with 6 tips: #1 and #2 Phillips®, 1/4" and 3/16" Slotted, 1/4" and 5/16" Nut Driver
- Convenient and space saving, ideal for kitchen drawer or car – no need for extra screwdrivers
- Ergonomically designed bi-material handle for superb comfort
- Tri-lobe shape fits hand comfortably
- Soft, diamond textured handle provides a firm grip for extra torque without strain
- Bar is chrome-plated for rust resistance.
- Attach wrench to bolster nut for additional leverage and torque
- High quality bits for long life
- Available in an attractive 24 piece merchandiser
- Slip resistant rubber grip provides comfort

NEW SKU#	SKU#	CONTENTS	O / A LENGTH		BOX CTN
			mm	inches	
STHT68012-8	68-012	1/4", 3/9" Slotted 1PT, 2PT, Phillips® 1/4", 5/6" Nut Driver	7.75	196.9"	6/24

#### Cushion Grip Multi Bits 2-Way



- Bi-Material Handle for comfortable grip
- Larger handles for greater torque
- Chrome plated bars for rust resistant
- Magnetized Tips

SKU#	CONTENTS	O / A LENGTH		BOX/CTN
		mm	inches	
65-201	Slotted 6mm x 100mm	6 x 100	1/4" x 4"	12/72
	Phillips #2 x 100mm	#2 x 100	#2 x 4"	

#### 10-Piece Multi-Bit Ratcheting Screwdriver



- Bit storage system for easy visibility, access and security
- Magnetic bit holder for quick, secure change-over of bits
- Top quality, three-position audible ratcheting mechanism; forward, reverse and fixed for lifelong efficiency
- Supplied with 10 bits to suit a wide variety of purposes

NEW SKU#	SKU#	CONTENTS	O / A LENGTH		BOX/CTN
			mm	inches	
STHT68010-8	68-010	Ratcheting screwdriver c/w 10 bits 1&2PT – Philip / Pozi / Robertson 5&6.5mm slotted T10 & T15 Torx	254	10"	6/36



## Screwdriver Insert Bit Set

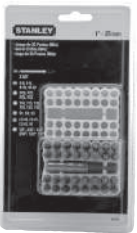

- Made from chrome vanadium steel
- Recommended for manual applications in multi-bit screwdrivers

NEW SKU#	SKU#	CONTENTS	INDIVIDUAL PRODUCT			BOX/ CTN
			length	width	height	
68-070-23	68-070	9 pc set: Phillips #1,#2,#3,PZ2,S2 Slotted 3/16",1/4",5/16"	21.2"	16.4"	1.5"	6/36
68-071-23	68-071	29 pc set: Phillips #1,#2,#3,PZ1,PZ2,PZ3,S2 Slotted 6/8",8/10",10/12" Torx T5,T20,T25, T30 Hex 3/32",1/8",5/32",S1, S2,S3 Nutdriver 3/16",1/4",5/16",11/32",3/8", Bit Hold	21.2"	15"	2"	6/48
68-072-23	68-072	33 pc set: 6.35mm / 1/4" 1pc 2-3/8" bits holder Phillips 2x#0,3x#1,3x#2,1x#3 Slotted 5-6,6-8,8-10,10-12 POZI 0,1,2,3 Star T10-15- 20-25-30-40 Square S1,S2,S3 Hex 1/8", 3/32", 5/32", 3/16", 7/32",1/4"	21.2"	22.4"	3.4"	6/48
68-075-23	68-075	36 pc set: Phillips #1,#1,#2,#2,#3,PZ0,PZ1,PZ 1,PZ2,P2, PZ3,S0,S1,S1,S2,S2,S3 Slotted 1/8",3/16",1/4",7/32" Torx T10,T15, T20a,T25,T27,T30 Hex 1/16", 1/8",5/32",3/16",7/32",1/4"	21.2"	15"	3.2"	6/36

## 9 Way Screwdriver™

- 9 tips for all access
- Convenient & space saving
- Ergonomically designed bi-material handle
- Bar is chrome plated for rust resistance
- 10pc Cushion Grip Driver Set :
- 3pc Philip #0, #1, #2, 3 pcs Standard 1/8", 3/16", 1/4", 1 Awl, 1 Tack Puller, 1 Hook Driver
- BOX/CTN: 6/24



NEW SKU#	SKU#	CONTENTS	BOX/CTN
STHT62511-8	62-511	9 Way Interchangeable Screwdriver 10pc Cushion Grip Driver Set: 3pc Phillips® - #0, #1, #2 3pc Standard - 1/8", 3/16", 1/4" 1 Awl - 1 pc 1 Tack Puller - 1pc1 Hook Driver - 1pc	6/24

### 3 FASTENING TOOLS



#### 6-Piece Bi-Material Handle Precision Screwdriver Set



- Attractive bi-material handles designed for easy and comfortable grip
- Chrome vanadium steel bars in black oxide finished with hardened tips - HRC 53
- Comes in 6 popular sizes

NEW SKU#	SKU#	CONTENTS	BOX/CTN
STHT66052-8	66-052	0 & 1 pt Phil, 1.4, 2, 2.4, 3mm Standard	12/72
STHT66039-8	66-039	0 & 1 pt Phil, 1.4, 2, 2.4, 3mm Standard	12/72

#### Spark Detecting Screwdriver



- Test range of 100~500V
- Pocket size model c/w clip
- Attractive PP card packaging

NEWSKU#	SKU#	BLADE LENGTH		O / A LENGTH		TIP WIDTH		BOX/CTN
		mm	inches	mm	inches	mm	inches	
66-119-S	66-119	68	2-3/4"	140	5-1/2"	3	1/8"	20/600
66-120-S	66-120	100	4"	190	7-1/2"	5	3/16"	20/480

#### Multifunctional Digital Tester With LCD Display and Neon Lamp Display



- Easy single button operation
- Easy to read & practical screen
- Ergonomic design & shape , Bi-Material body combination
- Pocket clip for easy carrying
- Neon lamp for electriciferous test
- International standard, CE certified
- Rubber hands provides comfort & insulation

SKU#	DESCRIPTION	BOX/CTN
66-133	Multifunctional Digital Tester with LCD Display and Neon Lamp Display	12/96

#### Multifunctional Digital Tester With LCD Display



Induction test, break-point & voltage reading button

- Easy to read & practical screen
- Pocket clip for easy carrying
- International standard, CE certified
- Longer tip for deep insertion

NEW SKU#	SKU#	DESCRIPTION	BOX/CTN
66-137-S	66137	Multifunctional Digital Tester with LCD Display	12/240

## Hex Key Set

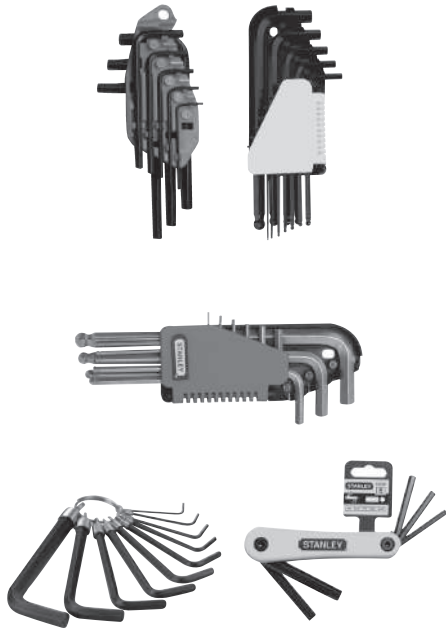

SKU#	DESCRIPTION	CONTENTS	BOX/CTN
69-261	Hex Key Set 7pc Fldg MM	1.5/2/2.5/3/4/5/6 mm	12/72
69-262	Hex Key Set 7pc Fldg MM	2.5/3/4/5/6/8/10 mm	12/48
69-251	Hex Key Set 8pc S/arm MM	1.0/1.5/2/2.5/3/4/5/5.5/6 mm	12/72
69-256	Hex Key Set 9pc L/arm MM	1.5/2/2.5/3/4/5/6/8/10 mm – Ball tips	6/36
69-213	Hex Key Set 10pc Ring MM	1.5/2/2.5/3/4/5/5.5/6/8/10 mm	12/72
69-253	Hex Key Set 10pc S/arm MM	1.5/2/2.5/3/4/5/5.5/6/8/10 mm	12/72
69-260	Hex Key Set 5pc Fldg IMP	3/16, 7/32, 1/4, 5/16, 3/8	12/48
69-252	Hex Key Set 8pc S/arm IMP	1/16, 5/64, 3/32, 1/8, 5/32, 3/16, 7/32, 1/4"	12/72
69-259	Hex Key Set 9pc Fldg IMP	5/64, 3/32, 7/64, 1/8, 9/64, 5/32, 3/16, 7/32, 1/4"	12/72
69-230	Hex Key Set 10pc Ring IMP	1/16, 5/64, 3/32, 1/8, 5/32, 3/16, 7/32, 1/4, 5/16, 3/8"	12/72
69-254	Hex Key Set 10pc S/arm IMP	1/16, 5/64, 3/32, 1/8, 5/32, 3/16, 7/32, 1/4, 5/16, 3/8"	12/72
69-257	Hex Key Set 12pc L/arm IMP	1/16, 5/64, 3/32, 7/64, 1/8, 9/64, 5/32, 3/16, 7/32, 1/4, 5/16, 3/8" – Ball tips	6/36
69-263	Hex Key Set 8pc Fldg Torx®	T9/ T10/ T15 / T20/ T25/ T27 T30/ T40	12/72

1 MEASURING & LAYOUT TOOLS

2 CUTTING & HOLDING TOOLS

3 FASTENING TOOLS

4 STRIKING & STRUCK TOOLS

5 PAINTING & FINISHING TOOLS

6 MECHANIC TOOLS

7 TOOLS STORAGE

### 3 FASTENING TOOLS

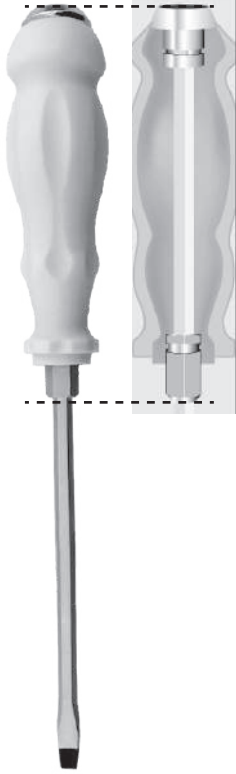

#### Tank Thru Screwdriver

- Hexagonal Shape Blade
- Black tip with magnetic feature
- Heavy-duty purpose
- Material: S2 Steel Blade
- Ergonomic Handle Design
- Oil resistant TRP + PP Material on the Handle

NEW SKU#	SKU#	DESCRIPTION	SIZE		BOX / CTN
			Blade Tip	Blade Dia. x Length	
STMT61889	65-247-1	Tank Thru Screwdriver	6mm x 4" (100mm)	Std 0.94 x 6.35	12/120
STMT61891	65-249-1	Tank Thru Screwdriver	6mm x 6" (150mm)	Std 0.94 x 6.35	12/120
STMT61893	65-254-1	Tank Thru Screwdriver	8mm x 8" (200mm)	Std 1.07 x 7.94	12/72
STMT61894	65-255-1	Tank Thru Screwdriver	8mm x 10" (250mm)	Std 1.07 x 7.94	12/72
STMT61895	65-256-1	Tank Thru Screwdriver	8mm x 12" (300mm)	Std 1.07 x 7.94	12/72

NEW SKU#	SKU#	DESCRIPTION	SIZE		BOX / CTN
			Blade Tip	Blade Dia. x Length	
STMT61880	65-250-1	Tank Thru Screwdriver	6mm x 4" (100mm)	Phil 2PT	12/120
STMT61881	65-251-1	Tank Thru Screwdriver	6mm x 5" (125mm)	Phil 2PT	12/120
STMT61882	65-252-1	Tank Thru Screwdriver	6mm x 6" (150mm)	Phil 2PT	12/120
STMT61890	65-260-1	Tank Thru Screwdriver	8mm x 12" (300mm)	Phil 3PT	12/72

#### GluePro™ Mini Hot Melt Glue Gun



- Small, portable size for quick gluing jobs in tight spaces
- Trigger-feed mechanism controls glue flow
- Uses GS10DT standard mini hot melt sticks
- Fold-out stand for safe, handy storage while in use

NEWSKU#	SKU#	CONTENTS	GLUE STICK	BOX/CTN
69-GR10B-23	69-GR10B	Mini Hot Melt Glue Gun 100-240V/15W - Round Pin	GS10DT	6/36
69-GR10C-23	69-GR10C	Mini Hot Melt Glue Gun 100-240V/15W - Flat Pin	GS10DT	6/36

#### GluePro™ Mini Dual Temp Melt Glue Gun



- Ideal for hobbies, crafts and repairs
- Convenient, one-touch high/low selector switch
- Uses mini dual-temperature glue on both settings and mini hot-melt on high settings
- Fold-out stand for safe, handy storage while in use

NEWSKU#	SKU#	CONTENTS	GLUE STICK	BOX/CTN
69-GR15C-23	69-GR15C	Mini Dual Temp Glue Gun 100-240V/15W - Flat Pin	GS10DT	6/36

#### GluePro™ Trigger Feed Hot Melt Glue Gun



- Quality engineered for reliable performance
- Trigger-feed mechanism controls glue flow
- Heats up quickly and bonds within 60 seconds
- Uses standard GS10DT hot melt glue sticks
- Fold-out stand for safe, handy storage while in use

NEWSKU#	SKU#	CONTENTS	GLUE STICK	BOX/CTN
69-GR20B-23	69-GR20B	Trigger Feed Hot Melt Glue Gun 100-240V/40W - Round Pin	GS20DT 25DT/GS260 & 500	6/24
69-GR20C-23	69-GR20C	Trigger Feed Hot Melt Glue Gun 100-240V/40W - Flat Pin	GS20DT 25DT/GS260 & 500	6/24

#### GluePro™ Trigger Feed Dual Melt Glue Gun



- Offers the versatility of high and low temperature gluing in one gun
- Convenient, one-touch high/low selector switch
- Uses standard dual-temperature glue on both settings and hot melt formulas on high setting
- Heats up quickly and bonds within 60 seconds
- Fold-out stand for safe, handy storage while in use

NEWSKU#	SKU#	CONTENTS	GLUE STICK	BOX/CTN
69-GR25B-23	69-GR25B	Trigger Feed Dual Melt Glue Gun 100-240V/80W - Round Pin	GS20DT 25DT/GS260 & 500	6/24

#### GluePro™ Cord Free 2-Way Glue Gun



- Versatile glue gun works with or without cord
- Cordless operation for up to 12 minutes
- Heats up quickly
- Fold-out stand for safe, handy storage while in use

NEWSKU#	SKU#	CONTENTS	GLUE STICK	BOX/CTN
69-GR90B-23	69-GR90B	Cord Free 2 Way Glue Gun 100-240V/40W - Round Pin	GS20DT 25DT/GS260 & 500	6/24

1 MEASURING & LAYOUT TOOLS

2 CUTTING & HOLDING TOOLS

3 FASTENING TOOLS

4 STRIKING & STRUCK TOOLS

5 PAINTING & FINISHING TOOLS

6 MECHANIC TOOLS

7 TOOLS STORAGE

### 3 FASTENING TOOLS



#### Dual Temp 4" Mini Glue Stick

- For use in mini hot melt, low temperature, and dual temperature glue guns
- Excellent for bonding heat sensitive materials, as well as general applications

SKU#	LENGTH		FOR	PACK(BOX)	BOX/CTN
	mm	inches			
GS10DT	100 x 7.1	4" x 0.28"	GR10, GR15 glue guns	24 pcs	5/60



#### Dual Temp 4" Glue Stick

- For use in mini hot melt, low temperature, and dual temperature glue guns
- Excellent for bonding heat sensitive materials, as well as general applications
- Standard diameter glue sticks in 4" length

SKU#	LENGTH		FOR	PACK(BOX)	BOX/CTN
	mm	inches			
GS20DT	100 x 11.3	4" x 0.45"	GR20, GR25 & GR90	24 pcs	5/60
GS25DT	254 x 11.3	10" x 0.45"	GR20, GR25 & GR90	12 pcs	5/50



#### Formula II - Super Strength 4" Glue Stick

- Extra strength adhesive
- Standard diameter glue sticks in 4" length

SKU#	LENGTH		FOR	PACK(BOX)	BOX/CTN
	mm	inches			
GS500	100 x 11.3	4" x 0.45"	GR20, GR25 & GR90	6 pcs	5/60



#### MaxSteel™ C-Clamp

- High-visibility, corrosion-resistant finish
- Advanced frame design resists flexing and bending
- Heavy-duty, malleable iron and steel construction
- Roll-formed screw threads ensure smooth operation and durability
- Oversized "T" handle for extra torque

SKU#	LENGTH		BOX/CTN
	mm	inches	
83-032K	33 x 50	2" x 1-5/16"	12/72
83-033K	57 x 75	3" x 2-1/4"	6/36
83-034K	75 x 100	4" x 3"	6/24
83-036K	100 x 200	8" x 4"	3/6

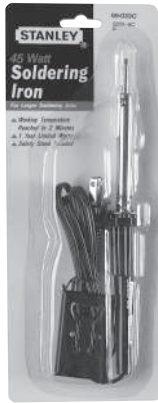

## Soldering Iron

- Suitable for soldering metals like copper, tin, brass and stained glass
- Working temperature reached in 2 minutes
- Slim pencil like handle for easy use and control

SKU#	PIN HEAD	CAPACITY	BOX/CTN
69-031B	Round	30W/220V	20/80
69-031C	Flat	30W/220V	20/80
69-033B	Round	45W/220V	20/80
69-033C	Flat	45W/220V	20/80



## Soldering Gun

- Suitable for soldering light gauge wires, thin metals and hobby work
- Reaches working temperature in 12 seconds
- Come with 2 soldering tips

SKU#	CONTENTS	PIN HEAD	BOX/CTN
69-041B	100W/220V Complete kit comprising: Soldering gun. Tip Solder	Round	6/24
69-041C	100W/220V Complete kit comprising: Soldering gun. Tip Solder	Flat	6/24



## Riveter

- 69-799 body is nickel-plated
- Versatile tool for joining sheet metal, fabric, leather, plastic parts, etc
- Spring loaded handle ejects rivets stem
- All steel body with non-slip grip and wrench for changing nosepieces

NEWSKU#	SKU#	CONTENTS	BOX/CTN
STHT69646-8	69-646	Medium-duty riveter c/w 3 nosepieces for 1/8", 5/32", 3/16" rivets	5/30
STHT69800-8	69-799	Heavy-duty riveter c/w 4 nosepieces for 3/32", 1/8", 5/32", 3/16" rivets	6/24

## Swivel Head Riveter

- 360° rotating head, makes it easy to apply rivets in tight spaces
- Rugged die-cast metal construction for long life
- Extra nose pieces and wrench are conveniently stored in handle
- Long handle makes riveter easy to squeeze



NEWSKU#	SKU#	DESCRIPTION	BOX/CTN
MR77C-22	MR77C	Swivel Header Riveter	6/24

## 3 FASTENING TOOLS



### Light-Duty Staple Gun

- Perfect for everyday stapling needs around the home or office
- Lightweight with convenient handle lock for safe storage
- Quick-jam-clear mechanism saves time and hassles
- Chrome-plated steel construction for durability

SKU#	STAPLE USED	BOX/CTN	MOQ
TR45	TRA200 or Arrow® JT-21® light-duty staples	40/720	-
TR110	SharpShooter® TRA700 or ArrowT-50® heavy-duty staples	1/3	3000



### Heavy-Duty Staple Gun

- Easy-squeeze handle reduces hand fatigue
- Anti-jam mechanism saves time on the job
- High-visibility yellow color easy to spot in a toolbox or workshop
- Durable aircraft-aluminum housing withstands heavy use
- Delivers high power and deep penetration
- Easy-slide full-stick staple load

SKU#	STAPLE USED	BOX/CTN
TR150	SharpShooter® TRA700 or Arrow® T-50® heavy-duty staples	1/6



### Heavy-Duty Staple Gun / Brad Nailer

- Easy-squeeze product works overtime as a staple gun, brad-nailer, cable-tacker and wire-tacker
- All-metal drive channel ensures better penetration
- Less force to squeeze and more driving power
- Heavy-duty aircraft-aluminum housing for long-lasting durability
- Hi/Lo power lever for hard and soft materials
- Flush-nose design solves the problem of stapling in tight spots
- Lock-down handle for safe storage
- Quick-view window simplifies staple identification
- Easy-slide full-stick staple load

SKU#	STAPLE USED	BOX/CTN
TR250	SharpShooter® TRA700 series or Arrow® T-50® heavy-duty narrow crown staples and 1/2", 9/16" and 5/8" Brads	1/6



## SharpShooter™ Staple



- For light-duty household and crafting stapling jobs
- Colour-coded packaging makes size and product selection a cinch
- Sturdy plastic packaging reduces staple breakage
- Light-Duty - Narrow Crown - fits TR45 and Arrow® JT-21
- Heavy-Duty - Narrow Crown - fits TR110, TR200, TRE500 Series, PHT150, PHT250 and Arrow® T-50

NEW SKU#	SKU#	DESCRIPTION	HEIGHT		PACK SIZE	BOX/CTN
			mm	inches		
TRA204T	TRA204	1/4" Light-Duty Staples	6	1/4"	1,000 pcs	7/56
TRA205T	TRA205	5/16" Light-Duty Staples	8	5/16"	1,000 pcs	6/48
TRA206T	TRA206	3/8" Light-Duty Staples	10	3/8"	1,000 pcs	5/40

NEW SKU#	SKU#	DESCRIPTION	HEIGHT		PACK SIZE	BOX/CTN
			mm	inches		
TRA704T	TRA704T	1/4" Heavy-Duty Staples	6	1/4"	1,000 pcs	7/56
TRA705T	TRA705T	5/16" Heavy-Duty Staples	8	5/16"	1,000 pcs	6/48
TRA706T	TRA706T	3/8" Heavy-Duty Staples	10	3/8"	1,000 pcs	5/40
TRA709T	TRA709T	9/16" Heavy-Duty Staples	14	9/16"	1,000 pcs	4/32

STAPLE SELECTION GUIDE		SUITABLE FOR STAPLERS				
Staples	Size	TR250	TR150HL	TR150	TR110	TR45
		Heavy-Duty Staples				
TRA704T	1/4"	•	•	•	•	
TRA705T	5/16"	•	•	•	•	
TRA706T	3/8"	•	•	•	•	
TRA709T	9/16"	•	•	•	•	
Light-Duty Staples						
TRA204	1/4"					•
TRA205	5/16"					•
TRA206	3/8"					•

1 MEASURING & LAYOUT TOOLS  
 2 CUTTING & HOLDING TOOLS  
 3 FASTENING TOOLS  
 4 STRIKING & STRUCK TOOLS  
 5 PAINTING & FINISHING TOOLS  
 6 MECHANIC TOOLS  
 7 TOOLS STORAGE

# 4 STRIKING AND STRUCK TOOLS

## POWERFUL, QUALITY AND ADVANCE

STANLEY®'s world-renown and world-class research and development teams design hammers that not only exceed customers' expectations, but also live up to the proud STANLEY® name. And in its state-of-the-art manufacturing facilities, STANLEY® produces hammers made from the finest materials available, including wood, fiberglass, steel and graphite. At STANLEY®, every hammer is engineered with safety in mind. That's why you'll find shock absorption features on many of our striking tools. You'll also find balanced heads, ergonomically-designed grips and handles shaped to prevent slipping. You can be confident that STANLEY® hammers exceed the industry standard for safety and durability.

### WHY STANLEY® HAMMER?

#### 1 Superior quality

10 extensive tests to ensure the best quality on the market

- Pound Test
- Handle Bend Test
- Head Pull Test

#### 2 Technology

- STANLEY® is the only hammer that is rim tempered to reduce spalling
- Patent Pending 70%+ Large strike face for striking accuracy
- Patented AntiVibe® reduces are damaging vibrations
- Patented Stabilizers reduce arm twisting torsion

### HAMMER TERMINOLOGY

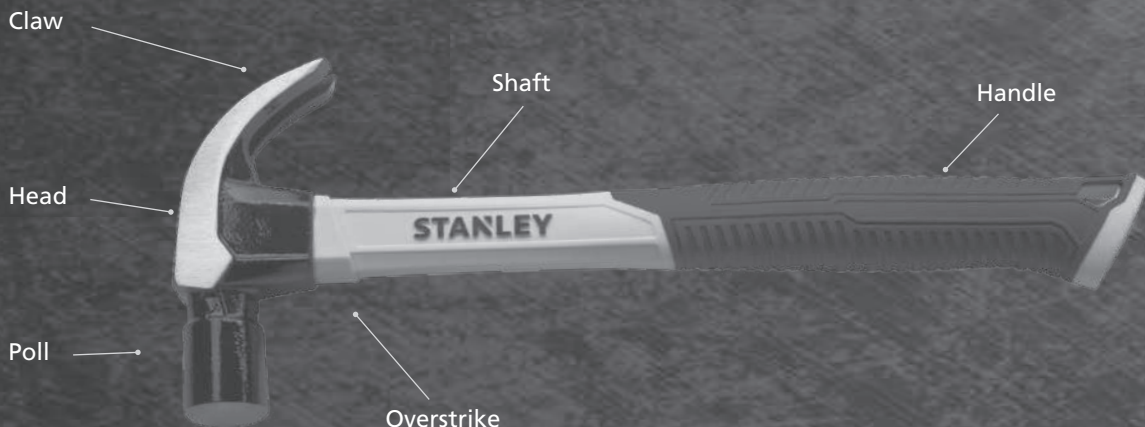



## USE THE RIGHT WEIGHT OF HAMMER

Choosing the right weight is important, because there is no benefit in lifting a 22oz hammer to drive nails no longer than 50mm (2"). In the same way a 16oz hammer will make heavy work in driving a 75mm nail. As a reasonable compromise a 20oz claw hammer is a good general-purpose choice.

## HAMMER END USER CUES

### HEAD TYPE



### BALL TYPE



### CURVE CLAW

#### 1 Head Type

- Curve Claw = DIY
- Ball Pein = Pro
- 10 Specialty Head Types = Pro, Advanced DIY

#### 2 Handle Length

- < 14" = DIY and Pro
- > 14" = Pro (Framing)

#### 3 Durability

- 2pc = Wood, Fiberglass, Graphite, Steel & Titanium
- 1pc = Steel and Titanium

#### 4 Weight

- DIY = 7oz, 13oz, 16oz
- Pro = 16oz, 20oz, 22oz, 28oz

#### 5 Grip Feel

#### 6 Balance

#### 7 Face

- Smooth
- Checked

## 4 STRIKING & STRUCK TOOLS



TIP



MALLET

### Mallet Hammer

- Plastic tips on this hammer are designed to wear away as they protect the surface being struck
- Replacement is as easy as unscrew off the old tip and screw on the new one
- Forged, high carbon, quality steel head

SKU#	MALLET HEAD LENGTH		BOX/CTN
	mm	inches	
56-114	35	1.3	6/36

### Jacketed Steel Handle Hammer



- Shaft 15% longer for better balance & control in usage
- Grip 15% longer for better performance
- Individually heat-treated for long life
- Hardened and tempered tubular steel shaft for strength
- Flock-filled rubber grip for comfort and durability
- Meets ANSI standards

NEW SKU#	SKU#	HEAD LENGTH		WEIGHT		BOX/CTN
		mm	inches	grams	oz	
51-081-23	51-081	335	13-1/4"	450	16	6/36
51-082-23	51-082	335	13-1/4"	570	20	6/36

### Fiberglass Nail Hammer



- Fully Heat Treated & Polished Bell Face Offers longer striking life
- Fiberglass Shaft Absorbs shock and vibration
- Thicker Joint To withstand overstrike
- Meets ANSI standards
- Soft Grip handle provides comfort and anti-slip



SKU#	HEAD WEIGHT			BOX/CTN
	mm	grams	oz	
STHT51390	304	195	7	6/36
STHT51391	343	450	16	6/36
STHT51392	347	565	20	6/36

### Jacketed Fiberglass Engineering Hammer



- Heat treated high carbon alloy steel heads for long life and durability
- Machined striking face for accuracy
- Jacketed fiberglass handle for overstrike protection

SKU#	HEAD LENGTH		WEIGHT		BOX/CTN
	mm	inches	grams	oz	
56-202	112	4-3/8"	1100	40	4/4
56-204	135	5-1/4"	1800	64	4/4

## 4 STRIKING & STRUCK TOOLS



### Jacketed Fiberglass Drilling Hammer

- New England pattern head is forged from high grade, hardened, tempered steel
- Machined striking face for accuracy
- Jacketed fiberglass handle for overstrike protection

SKU#	HEAD LENGTH		WEIGHT		BOX/CTN
	mm	inches	grams	oz	
56-701	106	4-1/4"	930	32	4/4
56-705	116	4-1/2"	1400	50	4/4



### Jacketed Fiberglass Blacksmith Hammer

- Heat treated high carbon alloy steel heads for long life and durability
- Machined striking face for accuracy
- High visibility yellow handle is made of jacketed fiberglass for strength and durability

SKU#	HEAD LENGTH		WEIGHT		BOX/CTN
	mm	inches	grams	oz	
56-218	125	5"	1100	40	4/4



### Wood Handle Nail Hammer

- The hammer head is attached with 2 wedges for better durability
- Natural hardwood handle
- Meets ANSI standards
- Hammer claws 15% longer for greater ease in pulling nails

NEW SKU#	SKU#	HEAD LENGTH		WEIGHT		BOX/CTN
		mm	inches	grams	oz	
STHT51373-8	51-269	330	13"	370	13	6/36
STHT51339-8	51-271	330	13"	450	16	6/36
STHT51374-8	51-274	335	13-1/4"	570	20	6/36



### Ball Pein Hammer

- The hammer head is attached with 2 wedges for better durability
- Ball end used for riveting and poll used for normal striking
- Meets ANSI standards
- Handle 25% longer in 16-32oz sizes for better balance and control

SKU#	HEAD LENGTH		WEIGHT		BOX/CTN
	mm	inches	grams	oz	
STHT54189-8	311	12-1/4"	230	8	6/48
STHT54190-8	345	13"	340	12	6/48
STHT54191-8	355	14"	450	16	6/36
54-192-23	381	15"	680	24	6/24
54-193-23	405	16"	910	32	6/24

1 MEASURING & LAYOUT TOOLS

2 CUTTING & HOLDING TOOLS

3 FASTENING TOOLS

4 STRIKING & STRUCK TOOLS

5 PAINTING & FINISHING TOOLS

6 MECHANIC TOOLS

7 TOOLS STORAGE

## 4 STRIKING & STRUCK TOOLS



### Contractor Grade™ Hickory Handle Engineering Hammer



56-804

- Forged steel head-hardened and tempered
- Faces machine finished
- Selected clear lacquered hickory handle

SKU#	HEAD LENGTH		WEIGHT		BOX/CTN
	mm	inches	grams	oz	
56-803	130	5-1/8"	1,400	50	4/4
56-804	135	5-1/4"	1,800	64	4/4

### Contractor Grade™ Hickory Handle Sledge Hammer



- Forged steel head-hardened and tempered
- Faces machine finished
- Selected clear lacquered hickory handle

SKU#	HEAD LENGTH		WEIGHT		BOX/CTN
	mm	inches	grams	oz	
56-808	165	6-1/2"	3,600	127	4/4
56-812	195	7-3/4"	5,400	190	4/4
56-816	215	8-1/2"	7,300	258	2/2

### Compo-Cast® Standard Head Soft Face Hammer



- Non-Sparking soft face hammers
- No exposed metal
- Soft face doesn't mar surfaces or equipment
- Steel reinforced handles provide added strength and safety, resist breaking on overstrike

SKU#	FACE DIAM.		HEAD LENGTH		O / A LENGTH		WEIGHT		BOX/CTN
	mm	inches	mm	inches	mm	inches	grams	oz.	
57-530	30	1.2"	79	3-1/8"	257	10-1/8"	284	10	1/4
57-531	40	1.6"	95	3-3/4"	286	11-1/4"	510	18	1/4
57-532	45	1.8"	103	4-1/16"	327	12-7/8"	595	21	1/4
57-533	53	2.1"	117	4-5/8"	362	14-1/4"	1,191	42	4/4
57-534	63	2.5"	140	5-1/2"	387	15-1/4"	1,474	52	1/2

### Rubber Mallet



- For striking blows where steel hammers would mar or damage surface of the work

SKU#	O / A LENGTH		WEIGHT		BOX/CTN
	mm	inches	grams	oz	
STHT57527-8	350	13"	450	16	6/36
STHT57528-8	350	13"	680	24	6/24

## 4 STRIKING & STRUCK TOOLS

### 1/8" (3.2mm) Center Punch



- This Center Punch has a 1/8" (0.125"/3.2mm) tip
- 4" overall length
- 5/16" stock size
- Square head
- Hardened & tempered alloy steel centre punch
- Tips are cupped & chamfered to locate accurately onto nail head

SKU#	COLOUR	O / A LENGTH		TIP		BOX/CTN
		mm	inches	mm	inches	
58-120	Grey	100	4"	3.2	1/8"	6/72



### 6-Piece Wood Carving Set

- Handy carving knives in various cut ideal for DIY handicrafts
- 1 ea square chisel
- 1 ea sken chisel
- 1 ea curved gouge
- 1 ea straight gouge
- 1 ea curved flat
- 1 ea curved U tool

NEW SKU#	SKU#	CONTENTS	BOX/CTN
STHT16120-8	16-120	Square & Sken Chisel, Curved & Straight Gouge, Curved flat, Curved U tool	12/72



### 150 Series - 3-Piece Wood Chisel Set

- Durable precision ground cutting edges
- Blades uniformly hardened for full length use
- Blades are also heat tempered and lacquer coated to prevent rust

SKU#	DESCRIPTION	LENGTH inches	BOX/CTN
16-089	3 pcs Wood Chisel Set	1/2" x 7-3/4" 3/4" x 7-3/4" 1" x 7-3/4"	5/30

### DynaGrip® Chisel

- Blade guard for storage safety
- Fully precision ground blade on all faces
- Ergonomic hi-impact resistant bi-material handle
- Rust-resistant, lacquered coated blade



NEW SKU#	NEW SKU#	CONTENTS		BOX/CTN
		mm	inches	
N/A	16-273	6	1/4"	6/36
N/A	16-275	10	3/8"	6/36
N/A	16-276	13	1/2"	6/36
N/A	16-278	16	5/8"	6/36
N/A	16-279	19	3/4"	6/36
N/A	16-281	22	7/8"	6/36
N/A	16-282	25	1"	6/36
N/A	16-283	32	1-1/4"	6/36
N/A	16-284	38	1-1/2"	6/36
N/A	16-285	13, 19, 25	1/2", 3/4", 1"	4/24

## 4 STRIKING & STRUCK TOOLS



### FatMax™ Concrete Chisel with Bi-Material Hand Guard

- Durable bull point that cuts fast and lasts long
- Ideal for cutting through and breaking up concrete

SKU#	CONTENT	LENGTH inches	BOX/CTN
16-329	Concrete Chisel 3/4" x 12" w/Guard	3/4" x 12"	3/18



### FatMax™ Floor Chisel with Bi-Material Hand Guard

- Used for cutting, prying or ripping of hardwood flooring and nails
- Designed with offset blade and shorter bite for increased leverage

SKU#	CONTENTS	LENGTH inches	BOX/CTN
16-331	FatMax™ Floor Chisel 3" x 11" with guard	3" x 11"	3/18



### FatMax™ Cold Chisel with Bi-Material Hand Guard

- For cutting/ shaping wrought iron, cast iron, steel, brass, bronze, copper, aluminum, bolts, nuts and rivets

SKU#	CONTENTS	LENGTH inches	BOX/CTN
16-332	FatMax™ Cold Chisel 1" x 12" with guard	1" x 12"	3/18



### STANLEY® Cold Chisel

- One-piece construction forged from chrome vanadium steel for increased strength and durability
- Hardened, quenched and tempered for long life and added safety
- Powder coat finish for increased visibility
- For cutting/ shaping wrought iron, cast iron, steel, brass, bronze, copper, aluminum, bolts, nuts and rivets

NEW SKU#	SKU#	LENGTH inches	BOX/CTN
STHT16287-8	16-287-2	1/2" x 6"	3/24
STHT16288-8	16-288	5/8" x 6-3/4"	3/24
STHT16289-8	16-289	3/4" x 6-7/8"	3/24
STHT16290-8	16-290	7/8" x 8"	3/24
STHT16291-8	16-291	1" x 12"	3/24

### Pin Punch

- One piece construction forged from tempered tool steel for strength
- Hardened and tempered for long life
- Powder coat finish for increased visibility

SKU#	LENGTH inches	BOX/CTN	MOQ
16-232	Pin Punch 5/32" x 6"	3/24	1008





## 4 STRIKING & STRUCK TOOLS



### Prick Punch

- Used for marking metal
- One-piece construction forged from tempered tool steel for strength
- Hardened and tempered for long life
- Powder coat finish for increased visibility

SKU#	LENGTH inches	BOX/CTN
16-236	3/8" x 5-1/2"	3/24



### Center Punch

- Used for marking metal or making indentations for starting drill holes
- One piece construction forged from tempered tool steel for strength
- Hardened and tempered for long life

SKU#	CENTER PUNCH inches	BOX/CTN
16-227	1/4" x 4"	3/24



### FatMax™ Wrecking Bar

- Forged, high-carbon steel able to withstand 975 ft-lbs, of bending momentum
- Tri-lobe design increases strength, durability and ease of use
- High-visibility, powder-coated finish
- Slotted claw and beveled ends improve functionality and performance

SKU#	OVERALL LENGTH		BLADE WIDTH		BOX/CTN
	mm	inches	mm	inches	
55-104	914	36"	38	1.5"	4/4



### Forged Hexagonal Steel Ripping Bar

- High carbon steel adds prying strength
- Chisel end is beveled
- Both slotted claw and chisel ends are polished

SKU#	LENGTH		BOX/CTN
	mm	inches	
55-118	16 x 455	5/8" x 18"	6/6
55-124	19 x 610	3/4" x 24"	6/6
55-130	19 x 760	3/4" x 30"	6/6

1 MEASURING & LAYOUT TOOLS

2 CUTTING & HOLDING TOOLS

3 FASTENING TOOLS

4 STRIKING & STRUCK TOOLS

5 PAINTING & FINISHING TOOLS

6 MECHANIC TOOLS

7 TOOLS STORAGE

# 5 PAINTING AND FINISHING TOOLS

## SMOOTH, FAST AND ACCURATE

STANLEY® is proud of its long-standing commitment to manufacturing some of the world's best finishing tools. Owning quality finishing tools says a lot about how serious a woodworker you are. STANLEY®'s line of finishing tools is made with quality materials. The parts are precision ground. And they have features that give woodworkers greater control and accuracy. STANLEY®'s celebrated line of Surform® tools, which comprises five different super-versatile implements designed for quickly smoothing, shaping and contouring a wide variety of materials ranging from wood, drywall and rabbit to copper, aluminum and brass. A wide variety of Surform® replacement blades is available too.

### WHAT IS SURFORM®?

The word SURFORM® is derived from the two words : SURface FORMing

- **ALL-IN-ONE:** Two-handed planes, files, one-handed planes and shaver
- **REPLACEABLE BLADES:** Blade provides the advantages over other tool alternatives, such as files; rasps and planes
  1. Rows of "D" shaped holes are punched through the blade
  2. Producing sharp chisel-like teeth
  3. After hardening, the teeth will cut through materials in the same way that a grater cuts cheese
  4. Shavings pass through the blade and do not clog

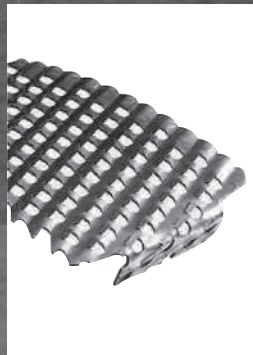

#### IDEAL FOR ANY SURFACE REMOVAL

- Remove paint
- Drywall edging
- Automotive body filler
- Filing
- Planing
- Shaving

### HOW TO USE SURFORM® TOOLS

For FAST CUTTING use the tool at an angle of about 30° to the direction of cut

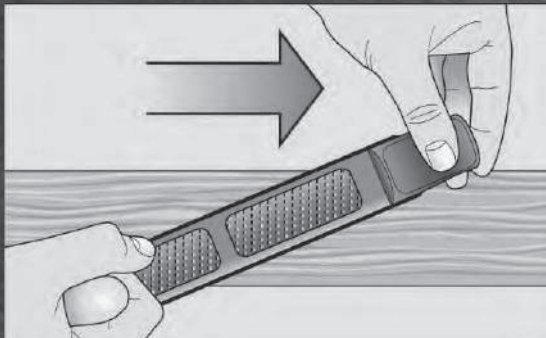

For SMOOTHING and FINISHING, use the tool parallel to the direction of cut

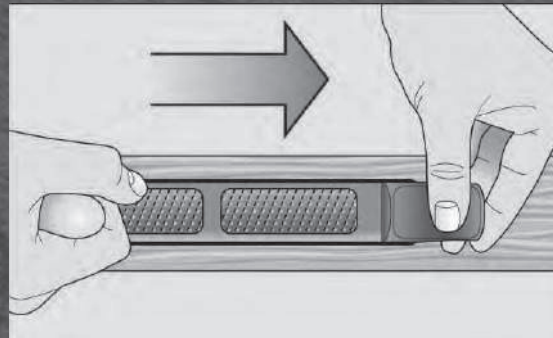



## SURFORM® TOOLS

**SURFORM® Shaver**



- Two handed use
- Light material removal
- Side cut teeth in blade useful for shaving in corners
- Works on the pull stroke

**Pocket Plane**



- One handed use
- Light wood removal
- ideal for end grain work, sheet rocking & smoothing edges of laminates

**SURFORM® Flat File**



- Two handed use
- Moderate to heavy wood removal
- Superb tool for use as a rasp on wood, plastic and soft metals

**SURFORM® Plane**



- Two handed use
- Moderate wood removal
- For materials that would dull a traditional bench plane blades

**Standard Cut**

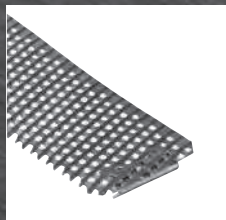

- Light material removal
- All-Purpose blade
- Serrated edge for edge cutting

**Fine Cut**

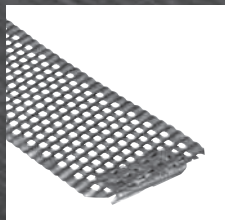

- Light wood removal
- Ideal for finishing work, end grain, wallboards and soft metals

**Round File**

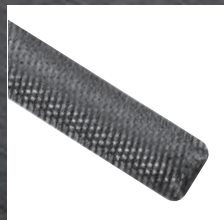

- Moderate wood removal
- Used for enlarging or changing the shape of holes or small concave edges

**Shaver**

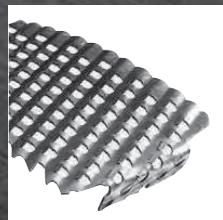

- Light material removal
- Side cut teeth in blade useful for shaving in corners

**Half Round**

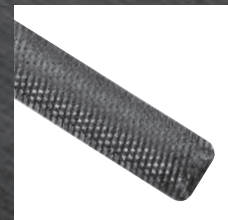

- Moderate wood removal
- Half Round convex blade used for fast stock removal and shaping curved surfaces

## 5 PAINTING & FINISHING TOOLS



### Paint Roller - Complete

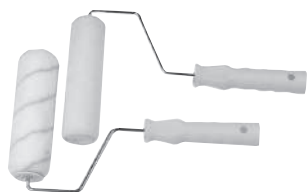

NEW SKU#	SKU#	CONTENTS	FOR USE ON	LENGTH		DIAMETER		BOX/CTN
				mm	inches	mm	inches	
1-29-064	29-064-1	7" Cage roller/ mogloss short refill	Gloss and eggshell paints on smooth surfaces	175	7"	37	1-1/2"	24/48
1-29-494	29-494-1	7" Cage roller/ acrylic med refill	Flat of masonry paint on semi smooth/rough surfaces	175	7"	37	1-1/2"	24/48
1-29-493	29-493-1	7" Cage roller/ acrylic long refill	Flat of masonry paint on semi smooth/rough surfaces	175	7"	37	1-1/2"	24/48
1-29-069	29-069-1	9" Cage roller/ mogloss short refill	Gloss and eggshell paints on smooth surfaces	255	9"	37	1-1/2"	24/48
1-29-401	29-401-1	9" Cage roller/ acrylic med refill	Flat/matt paint smooth/ semi smooth surfaces	255	9"	37	1-1/2"	24/48
1-29-400	29-400-1	9" Cage roller/ acrylic long refill	Flat/matt paint smooth/ semi smooth surfaces	255	9"	37	1-1/2"	24/48

### Mini Roller & Refill



NEW SKU#	SKU#	CONTENTS	FOR USE ON	LENGTH		BOX/CTN
				mm	inches	
1-29-814	29-814-1	Mini Roller Frame + Refill (29-086-0 + 29-816)	Water based gloss and eggshell	100	4"	24/48
2-29-078	29-078-2	Acrylic Yellow Stripe Refill- 2/pk	Flat/ matt paint on smooth surfaces	100	4"	10/100
5-29-078	29-078-5	Acrylic Yellow Stripe Refill- 10/pk	Flat/ matt paint on smooth surfaces	100	4"	10/20
2-29-816	29-816-2	High Density Foam Refill- 2/pk	Water based gloss and eggshell paints on smooth surfaces	100	4"	20/100
5-29-808	29-808-5	Velour Roller Refills	Velour Fabric for gloss paints on smooth surfaces	100	4"	10/20
1-29-480	29-480-1	Mini Roller Kit : 1 roller head for flat/ matt paint and 1 for gloss and varnish	Dual purpose - for emulsion and gloss	100	4"	24/48

## Cage Frame Roller Refill



NEW SKU#	SKU#	CONTENTS	FOR USE ON	LENGTH		DIAMETER		BOX/CTN
				mm	inches	mm	inches	
0-29-259	29-259-0	7" Acrylic Stripe Med Pile	Flat/ matt paint on smooth surfaces for 29-044-1 Cage Roller Frame	175	7"	37	1-1/12"	36/144
0-29-861	29-861-0	7" Mogloss Short Pile	Gloss and eggshell paints on smooth surfaces for 1-29-044 Cage Roller Frame	175	7"	37	1-1/12"	36/144
0-29-862	29-862-0	9" Mogloss Short Pile	Gloss and eggshell paints on smooth surfaces for 1-29-045-1 Cage Roller Frame	225	9"	37	1-1/12"	36/144

## Cage Frame Roller & Tray Set



NEW SKU#	SKU#	CONTENTS	FOR USE ON	LENGTH		DIAMETER		BOX/CTN
				mm	inches	mm	inches	
1-29-821	29-821-1	7" Rollers & Tray Set (29-044-1 + 29-259-0)	For flat/matt paint on smooth or semi surfaces	175	7"	37	1-1/2"	12/24
1-29-822	29-822-1	9" Rollers & Tray Set (29-045-1 + 29-279-0)	For flat/matt paint on smooth or semi surfaces	225	9"	37	1-1/2"	12/12

## Extension Pole



- 2.3m length, extends over 7ft
- Sturdy metal construction
- Easy twist
- Ideal for use with paint rollers and paint pads

NEW SKU#	SKU#	OVERALL LENGTH	BOX/CTN (DOZEN)
1-29-671	29-671-1	1.3 - 2.3m	1/24



## AllMaster Paint Brush

- Long bristle for durability and superior finish
- Wooden handle for comfort in use
- Stainless steel ferrules
- Superior finish with all paints



SKU#	SIZE		THICKNESS		LENGTH-OUT		BOX/CTN (DOZEN)
	mm	inches	mm	inches	mm	inches	
29-030-1	19	3/4"	9	11/32"	49	2"	12/288
29-031-1	25	1"	15	13/16"	58	2-1/4"	12/288
29-032-1	38	1-1/2"	18	5/8"	58	2-1/4"	12/288
29-033-1	50	2"	19	2/3"	67	2-5/8"	12/144
29-034-1	63	2-1/2"	20	2/3"	72	2-7/8"	12/144
29-035-1	75	3"	23	3/4"	79	3-1/8"	6/72
29-036-1	100	4"	23	3/4"	83	3-1/4"	6/72

## Planer File



- Can be used as either a plane or a file
- Fitted with replaceable standard cut blade and supplied with one spare blade

NEW SKU#	SKU#	DESCRIPTION	SIZE		PACKAGING	BOX/CTN
			mm	inches		
5-21-122	21-122-5	10" Surform Planer File	250	10"	Clamshell	2/12

## Block Plane



- One handed tool specially suited for smoothing edges and small surfaces areas

NEW SKU#	SKU#	DESCRIPTION	SIZE		PACKAGING	BOX/CTN
			mm	inches		
5-21-399	21-399-5	5-1/2" Surform®Block Plane	140	5-1/2"	Clamshell	2/24

## Standard Cut Blade



- All purpose blade
- Use on wood, vinyl, plaster thermalite, fiberglass and linoleum
- Standard cut blade features teeth flush to the blade edge for working into edges

NEW SKU#	SKU#	DESCRIPTION	LENGTH		WIDTH		FOR USE ON	BOX/CTN
			mm	inches	mm	inches		
5-21-293	21-293-5	Surform®Standard Cut Blade	250	10"	42	1-5/8"	21-103, 21-122, 21-195, 21-296	12/12

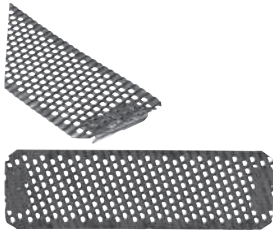

## Fine Cut Blade

NEW SKU#	SKU#	DESCRIPTION	LENGTH		WIDTH		FOR USE ON	BOX/CTN
			mm	inches	mm	inches		
5-21-398	21-398-5	Surform® Fine Cut Blade	140	5-1/2"	42	1-5/8"	21-102, 21-104, 21-399	12/12

## 10" Surform® Half Round Regular Cut Replacement Blade

- Length – 10", 254mm
- Width – 1-1/2", 38.1mm
- Cut Type - Regular
- Half-round convex blade used for fast stock removal and shaping curved surfaces
- Ideal for work on fiberglass and removing filler (for cars and boats)
- Can be used as a replacement blade on 21-295 Surform® Flat File - Regular Cut Blade and 21-296 Surform® Plane Type - Regular Cut Blade



NEW SKU#	SKU#	DESCRIPTION	LENGTH		WIDTH		FOR USE ON	BOX/CTN
			mm	inches	mm	inches		
5-21-299	21-299-5	Regular Cut Replacement Blade	254	10"	38.1	1-1/2"	21-295 21-296 21-122	12/12

## 2-1/2" Surform® Shaver Replacement Blade

- Length - 2-1/2"/63.5mm
- Width – 1-5/8", 41.28mm
- Cut Type – Regular
- Curved blade speeds up stock removal
- Works on the pull stroke
- Can be used as a replacement blade on 21-115, 7-1/4" Surform® Shaver

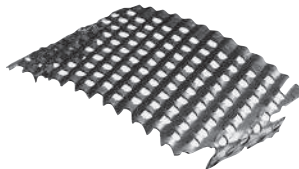

NEW SKU#	SKU#	DESCRIPTION	LENGTH		WIDTH		FOR USE ON	BOX/CTN
			mm	inches	mm	inches		
5-21-515	21-515-5	Surform Shaver Replacement Blade	63.5	2-1/2"	41.28	1-5/8"	21-115	12/12

## Retractable Razor Blade Scraper

- Removes paint, glue, putty or adhesive from glass, tile, walls, floors or other smooth surfaces
- Blade retracts for safe storage
- Uses standard single edge razor blades
- Comes with 5 blades



SKU#	DESCRIPTION	OVERALL LENGTH		CHUCK SIZE		BOX/CTN
		mm	inches	mm	inches	
28-500	Retractable Razor Blade Scraper	95	3-3/4"	-	-	10/100

## 5 PAINTING & FINISHING TOOLS



### 10-Pack Single Edge Razor Blades

- Steel-backed high carbon steel blade fits most standard razor blade tools
- Replacement blades for STANLEY® 28-100 and 28-500 scrapers

SKU#	DESCRIPTION	OVERALL LENGTH		Thickness	BOX/CTN
		mm	inches		
28-510	Scraper-bl'd for 28-500	38	1-1/2"	0.009"	10/100



### Single-Edge Razor Blade

- Steel backed high carbon steel blade fits all standard razor blade tools
- Replacement blades for 28-100 and 28-500 scrapers

SKU#	DESCRIPTION	OVERALL LENGTH		Thickness	BOX/CTN
		mm	inches		
11-515	Single Edge Razor Blade - 100pcs/Box	38	1-1/2"	0.009"	1/50



### Bailey® Professional Jack Plane

- For rapid stock removal prior to commencing construction work
- A good general purpose plane

NEW SKU#	SKU#	LENGTH		CUTTER		BOX/CTN
		mm	inches	mm	inches	
1-12-005	12-005-1	355	14"	50	2"	1/6



### Professional™ Block Plane

- Adjustable for depth of cut and alignment
- General purpose

NEW SKU#	SKU#	LENGTH		CUTTER		BOX/CTN
		mm	inches	mm	inches	
1-12-220	12-220-1	180	7"	40	1-5/8"	1/6



### Professional™ Block Plane

- Low angle cutter seats at 13-1/2"
- For end grain and plastic laminates

NEW SKU#	SKU#	LENGTH		CUTTER		BOX/CTN
		mm	inches	mm	inches	
1-12-060	12-060-1	150	6"	35	1-3/8"	1/6





## Block Plane

- General purpose block plane
- Ideal for model makers

NEW SKU#	SKU#	LENGTH		CUTTER		BOX/CTN
		mm	inches	mm	inches	
1-12-116	12-116-1	180	7"	40	1-5/8"	1/6



## Block Plane

- Small block plane - ideal for use by model makers

NEW SKU#	SKU#	LENGTH		CUTTER		BOX/CTN
		mm	inches	mm	inches	
1-12-102	12-102-1	140	5-1/2"	35	1-3/8"	1/6



## Professional Duplex Rabbet Plane

- Two cutter positions for regular and bull nose work
- Cutter adjustable for depth of cut in the rear position
- Supplied with an adjustable fence, depth gauge and cutting spur

NEW SKU#	SKU#	LENGTH		CUTTER		BOX/CTN
		mm	inches	mm	inches	
1-12-078	12-078-1	254	10"	38	1-1/2"	1/1



## Professional™ Smoothing Plane

- Fully adjustable for depth of cut, cutter alignment and size of mouth
- Cutter seats at 21°
- For end grain and general purpose fine finishing

NEW SKU#	SKU#	LENGTH		CUTTER		BOX/CTN
		mm	inches	mm	inches	
1-12-020	12-020-1	160	6-1/4"	40	1-5/8"	1/6



## Smoothing Plane

- Fine grey iron castings machined and ground for precision
- Fully hardened carbon chrome steel cutter is adjustable for depth of cut and alignment

NEW SKU#	SKU#	LENGTH		CUTTER		BOX/CTN
		mm	inches	mm	inches	
1-12-203	12-203-1	240	9-1/2"	45	1-3/4"	1/6
1-12-204	12-204-1	245	9-3/4"	50	2"	1/6
1-12-205	12-205-1	355	14"	50	2"	1/6

## 5 PAINTING & FINISHING TOOLS



### Bench Plane

- Light-duty, easy and simple to adjust smoothing planes

NEW SKU#	SKU#	LENGTH		CUTTER		BOX/CTN
		mm	inches	mm	inches	
1-12-034	12-034-1	247	9-3/4"	50	2"	1/6



### Spokeshaves Blade

- Heat-treated carbon steel

NEW SKU#	SKU#	COMPATIBLE TO -	WIDTH		BOX/CTN
			mm	inches	
1-12-350	12-350-1	12-151, 12-152	55	2-1/8"	6/6

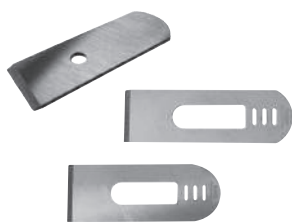

### Replacement Plane Iron

NEW SKU#	SKU#	COMPATIBLE TO -	WIDTH		BOX/CTN
			mm	inches	
0-12-504	12-504-0	12-060	35	1-3/8"	6/6
0-12-508	12-508-0	12-020 & 12-220	40	1-5/8"	6/6
0-12-330	12-330-0	12-116	40	1-5/8"	6/6



### Single Iron

- A flat surface that is easier to sharpen
- An accurately ground edge of 25°
- Use suffix '0' for carded product
- Chrome carbon steel which has excellent edge retention characteristics and allows a razor sharp edge to be honed

NEW SKU#	SKU#	CONTENTS	FOR USE ON	WIDTH		BOX/CTN
				mm	inches	
0-12-312	12-312-0	Iron-single 45mm 1-3/4"	12-003, 12-203	45	1-3/4"	6/6
0-12-313	12-313-0	Iron-single 50mm 2" (carded)	12-003, 12-205	50	2"	6/6



## Step #1 - Match file type to material shape

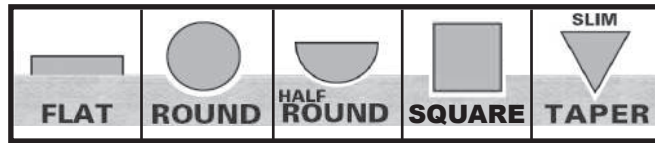

## Step #2 – Select File coarseness



Single cut for light removal of material



Double cut for moderate removal of material



Rasp cut for fastest removal of material

## Step #3 – Select Spacing of File Teeth



**Bastard Cut**  
General purpose sharpening and smoothing

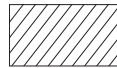

**Second Cut**  
Moderate cut for smoother finish

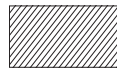

**Smooth Cut**  
Fine cut for sharpest edge on cutting tools

## Tapered File



- For sharpening handsaws

### INDIVIDUALLY CARDED

SKU#	DESCRIPTION	LENGTH		BOX/CTN (DOZEN)
		mm	inches	
22-090	Extra Slim Tapered - Second Cut	100	4"	1/12
22-091	Double Extra Slim Tapered - Second Cut	100	4"	1/12
22-093	Slim Tapered - Second Cut	200	8"	1/9
22-094	Slim Tapered - Second Cut	250	10"	1/6
22-214	Three Square Tapered - Bastard Cut	250	10"	1/6
22-304	Slim Tapered - Second Cut	100	4"	1/12
22-305	Slim Tapered - Second Cut	125	5"	1/12
22-306	Slim Tapered - Second Cut	150	6"	1/12

### BOX OF 12 PCS (BULK)

SKU#	BOX/CTN (DOZEN)
22-091B	1/6
22-092B	1/6
22-304B	1/200
22-305B	1/100
22-306B	1/6

## Round File

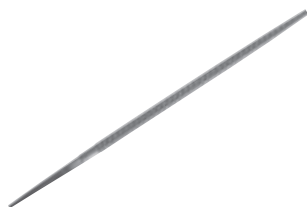

- For circular openings and concave surfaces

### INDIVIDUALLY CARDED

SKU#	DESCRIPTION	LENGTH		BOX/CTN (DOZEN)
		mm	inches	
22-179	Rounded - Second Cut	300	12"	1/4

### BOX OF 12 PCS (BULK)

SKU#	BOX/CTN (DOZEN)
22-179B	1/6
22-193B	1/6
22-236B	1/6
22-237B	1/6



## Half Round File

- For flat, concave and convex surfaces



### INDIVIDUALLY CARDED W/HANDLE

SKU#	DESCRIPTION	LENGTH		BOX/CTN (DOZEN)
		mm	inches	
22-189	Half-round 2nd Cut	300	12"	1/4
22-211	Half-round Smooth	200	8"	1/9

### BOX OF 12 PCS (BULK)

SKU#	BOX/CTN (DOZEN)
22-095B	1/6
22-096B	1/6
22-097B	1/6
22-172B	1/6
22-173B	1/6
22-177B	1/6
22-179B	1/6
22-186B	1/6
22-187B	1/6
22-188B	1/6
22-189B	1/6
22-191B	1/6
22-193B	1/6
22-194B	1/6
22-196B	1/6
22-309B	1/6

## Flat File

- For general work on iron & steel



### INDIVIDUALLY CARDED

SKU#	DESCRIPTION	LENGTH		BOX/CTN (DOZEN)
		mm	inches	
22-096	Mill bastard	250	10"	1/8
22-097	Mill bastard	300	12"	1/4
22-170-28	Flat Bastard	150	6"	1/12
22-173-28	Flat Bastard	300	12"	1/4
22-174-28	Flat 2nd Cut	150	6"	1/12
22-177	Flat 2nd Cut	300	12"	1/4
22-309	Mill Bastard	200	8"	1/9

### BOX OF 12 PCS (BULK)

SKU#	BOX/CTN (DOZEN)
22-097B	1/6
22-171B	1/6
22-172B	1/6
22-173B	1/6
22-177B	1/6
22-309B	1/6

## Handy File

- For sharpening agricultural tools including blades of reaping and mowing machines



### INDIVIDUALLY CARDED

SKU#	DESCRIPTION	LENGTH		BOX/CTN (DOZEN)
		mm	inches	
22-078H	File Handy 8" CW Handle	200	8"	1/6
22-078HC	Handy File - Bastard Cut	200	8"	1/6
22-080B	File-Handy 10" (12pcs/box)	250	10"	1/6

## Chain Saw File

- For sharpening chain saws



### INDIVIDUALLY CARDED

SKU#	DESCRIPTION	LENGTH		BOX/CTN (DOZEN)
		mm	inches	
22-083	Chain Saw File	5 x 200	3/16" x 8"	1/9

### BOX OF 12 PCS (BULK)

SKU#	DESCRIPTION	LENGTH		BOX/CTN (DOZEN)
		mm	inches	
22-082B	Chain Saw File	4 x 200	1/9" x 8"	1/75
22-083B	Chain Saw File	5 x 200	5/32" x 8"	1/75
22-087B	Chain Saw File	5.5 x 200	7/32" x 8"	1/75

## Square File



### INDIVIDUALLY CARDED

SKU#	DESCRIPTION	LENGTH		BOX/CTN (DOZEN)
		mm	inches	
22-197	Square - Smooth Cut	250	10"	1/6
22-216	Square - Second Cut	300	12"	1/4

### BOX OF 12 PCS (BULK)

SKU#	BOX/CTN (DOZEN)
22-194B	1/6
22-196B	1/6
22-197B	1/6
22-213B	1/6
22-215B	1/6
22-217B	1/6
22-218B	1/6

# 6 MECHANIC TOOLS

## STRONG, ECONOMICAL AND EFFECTIVE

The STANLEY® offering of Mechanic tools supplies professionals with a wide range of product options to successfully accomplish the job at hand.



### MAKE YOUR SOCKET SETS WORK HARDER

#### NUTS SHOULD TURN SMOOTHLY

To effectively use sockets you need to be sensitive to the way in which the nut turns on the bolt or screw stud. If the nut does not rotate smoothly check to see that the thread is not 'crossed' or if the thread size or type differs from the bolt.

#### TAKE CARE NOT TO OVER TIGHTEN

Run the nut up until finger tight and then apply the socket to finally tighten the nut. Under normal conditions do not be tempted to over tighten fastenings.

#### USE A TORQUE WRENCH FOR EXACT SPECIFICATIONS

If the torque required to complete the fastening needs to be specific for functional or safety reasons you should use a torque wrench.

#### USE THE RIGHT SIZE SOCKET

Even though the socket may locate on a nut that is slightly smaller the result may well be that the corners of the fastener will be deformed and make future removal difficult. The size of the ratchet handle is also carefully matched to a given set of socket sizes so that damage to the fastening is minimised. Whenever possible pull the ratchet handle towards you for better control.

#### LOCKING EXTENSION BAR

If you need to work on a fastener beyond your normal reach a locking extension bar will enable you to reach the nut without the risk of leaving the socket embedded in the machinery or engine compartment.

## SOCKETS

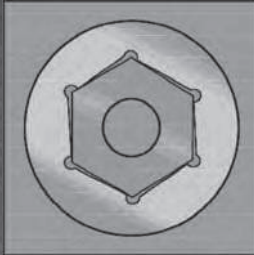

Sockets are available in either hex (6 points) or bi-hex (12 points). The bi-hex socket provides greater access when the nut is in a hard to reach position. The hex socket, although with reduced angular accessibility, tends to be able to withstand heavier duty use.

Maxi Drive profile sockets are the most efficient and offer protection to both the fastener and the socket wall by taking the driving force away from the extreme corners of the nut where there is the greatest risk of damage.

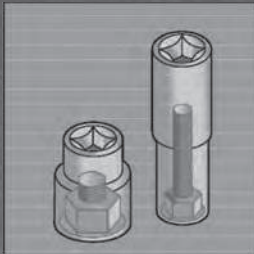

Sockets are available in standard length, for most general-purpose applications and deep drive, which come into their own if you need to tighten a nut on longer screw studs.

## THE RIGHT WRENCH FOR THE JOB

### COMBINATION SPANNERS

These combine in a single tool an open-ended jaw and a ring, both have the same dimension. The open-ended jaw is offset by 15° which enables the operator to turn any nut provided there is even a very small amount of access. The Bi-Hex (12 point) Ring end is also cranked at 15° from the horizontal, which enables you to grip the handle without risking injury to the knuckles.

### OPEN-ENDED SPANNERS

Both ends of these spanners are open with the heads set at 15°. The open-ended format is ideal for working on pipelines where only side access is possible. Select slim open-ended jaws to give greater accessibility within the thickness of the fastener.

### ADJUSTABLE WRENCH

This must be used carefully and sparingly if damage to the fastener is to be avoided, but it is still a very useful item for any toolkit.

### COMBINATION SPANNER WITH RATCHETING RING END

A very useful specialist set of 6 spanners with the benefit of a ring end which ratchets with a 5° angle of engagement so that you can work in very restricted spaces and have the added advantage of an open ended end profile to work on fastenings that do not have 360° access as occurs on pipe work.

### ACCELERATOR COMBINATION SPANNER

The open-end part of the tool incorporates an innovative jaw form which enables the user to engage and disengage without removing the spanner from the nut.

## RATCHETS

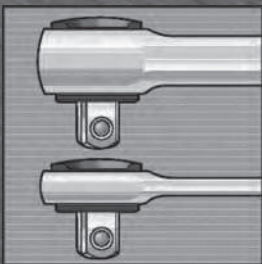

The turning force on the socket is imparted by the drive handle through a square recess forged into the end of the socket. The size of this recess varies depending on the size of the socket - 1/4" 3/8" or 1/2" square drive. Specific sets for each drive size are available, together with sets that combine drive sizes, which enable you to deal with fastenings from 4mm up to 32mm.

FatMax® and MicroTough™ ratchets offer the smoothest operation and allow access to fasteners in restricted areas. The smaller head is 20% - 30% smaller than standard ratchet heads and the fine tooth mechanism offers a 5° angle of engagement.

When working with oily hands it is important that the ratchet handle incorporates a quick socket release facility.

## 6 MECHANIC TOOLS



### "Full Polish" Quick Release Ratchet

ISO 3315 / DIN 3122

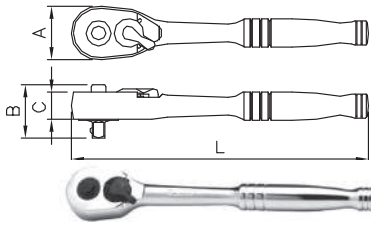

- Full polish finish, double-nickel with chrome plating for extra rust resistance and prolonged life
- Fine-tooth pear head ratchet 1/4" dr - 45 tooth gear and 3/8" & 1/2" 54 tooth gear design for small 6.8 degree arc swing
- Thin Head design for accessibility
- Quick release push button provide extra safety and handy operation
- Reversing level designed for quick, one hand operation

1/2"	NEW SKU#	SKU#	L mm	A mm	B mm	C mm	WEIGHT (g)	BOX/CTN
	STMT 89819-8B	89-819	253.0	41.0	35.3	18.0	586	4/24

### Round Head Ratchet

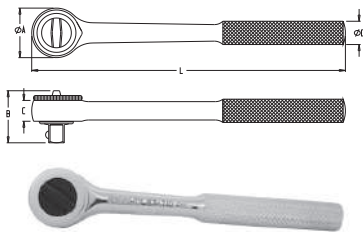

- Full polish finish, double-nickel with chrome plating for extra rust resistance and prolonged life
- Round head ratchet for tight access area
- Anti-slip and durable knurled metal handle design suit most industrial applications
- Flip drive ratchet head for easy directional rotation

1/2"	NEW SKU#	SKU#	L mm	A mm	B mm	C mm	D mm	WEIGHT (g)	BOX/CTN
	87-720-1	87-720	256.0	43.5	43.9	17.6	19.0	620	4/48

### Quick Release Ratchet - Round Head

ISO 3315 / DIN 3120

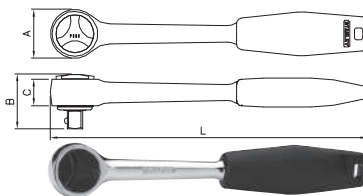

- Three way quick release ratchet head for directional rotation
- Round head ratchet for tight access area
- Comfortable and durable molded plastic handle withstands most industrial solvents
- Quick release push button provide extra safety and handy operation

1/2"	NEW SKU#	SKU#	L mm	A mm	B mm	C mm	WEIGHT (g)	BOX/CTN
	STMT 86397-8B	86-397-1	265.0	41.0	46.1	21.9	620	4/48

### Quick Release Ratchet - Pear Head

ISO 3315 / DIN 3122

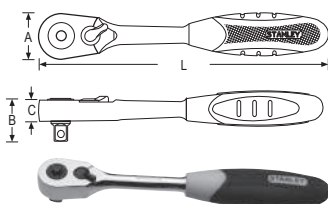

- Chrome vanadium steel (Cr-V) forging, hardness toughness
- High torque output, more than 50% of the ANSI standard, powerful to use, reliable and durable
- 60-tooth ratchet head design, turn 6 ° can drive sleeve, suitable for narrow space
- There are pros and cons of rapid shedding and commutation function, easy operation
- Dual material handle, oil slip, comfortable grip

1/2"	NEW SKU#	SKU#	L mm	A mm	B mm	C mm	BOX/CTN
	STMT 95893-8B	95-893	240	32.5	35.7	16.5	4/48



## Drive Round Head Ratchet Knurled Handle

ISO 3315 / DIN 3122

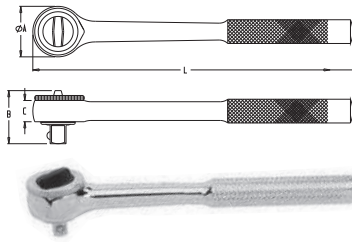

- Forged from high quality steel and finished in high-polish chrome
- Articulation angle of 8.4°
- Knurled handle for comfort and anti-slip operation
- Sockets and extensions remain locked onto the drive until disengaged with an easy-to-reach low-profile quick-release button

3/4"	NEW SKU#	SKU#	L mm	A mm	B mm	C mm	BOX/CTN
	STMT 91316-8B	91-316	495	65	55	30	2/8

## 72T Ratchet



- Large quick release button for easy removal of sockets
- Bi-Material handle for comfort and grip and control
- 72 Tooth Ratchet with one pawl mechanism for 5 degrees increment.
- Low profile switch lever prevents accidental switching and allows for easy, one-handed operation

SKU#	DESCRIPTION	DRIVE	HANDLE TYPE	TEETH	ANGLE	HEAD WIDTH	HEAD DEPTH	BOX/ CTN
STMT82663-0	1/4" 72T Ratchet	1/4	Bi-Material	72	5	25	23	12
STMT82664-0	3/8" 72T Ratchet	3/8	Bi-Material	72	5	33	30	12
STMT82665-0	1/2" 72T Ratchet	1/2	Bi-Material	72	5	40	39	12

## Sliding T-Bar

ISO 3315 / DIN 3122

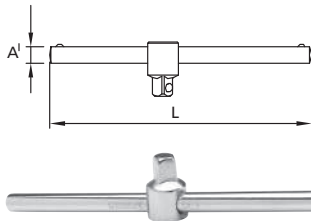

- Made of Chrome Vanadium Steel
- Allows the application of high torque using both hands
- Place the socket adapter at the extremes of the bar for higher leverage

3/4"	NEW SKU#	SKU#	L mm	A mm	WEIGHT (g)	BOX/CTN
	STMT 89303-8B	89-303-1	480.0	20.0	1400	2/18

## Flex Handle Bar

ISO 3315 / DIN 3122 (1/4" - 1/2") / ISO 1174 / DIN 3120 (3/4")

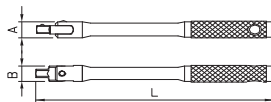

- Made of Chrome Vanadium Steel
- For applications where high leverage is needed to tighten or release a fastener



1/2"	NEW SKU#	SKU#	L mm	A mm	B mm	WEIGHT (g)	BOX/CTN
	N/A	86-413-1	439.0	28.0	20.1	713	6/36
	N/A	86-415-1	381.0	28.0	21.0	646	6/24

## Extension Bar

ISO 3316 / DIN 3123

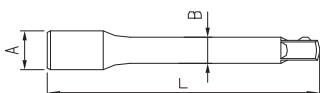

- Made of Chrome Vanadium Steel



1/2"	NEW SKU#	SKU#	SIZE	L mm	A mm	B mm	WEIGHT (g)	BOX/ CTN
	STMT 86407-8B	86-407-1	5"	125.0	22.5	16.3	204	4/40
	STMT 86408-8B	86-408-1	10"	252.0	22.5	16.3	398	4/48

## 6 MECHANIC TOOLS

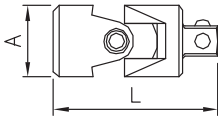

### Universal Joint

ISO 3316 / IN 3123

- Made of Chrome Vanadium Steel

1/2"	NEW SKU#	SKU#	L mm	A mm	WEIGHT (g)	BOX/CTN
	STMT 86411-8B	86-411-1	68.5	24.9	165	4/96

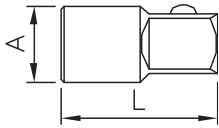

### Adapter

ISO 3316 / DIN 3120

- Made of Chrome Vanadium Steel
- Allows the use of a certain size drive ratchet with sockets of a different size

3/8"	NEW SKU#	SKU#	SIZE	L mm	A mm	WEIGHT (g)	BOX/ CTN
	STMT 86215-8B	86-215-1	3/8"Fx1/2"M	36.0	18.0	45	6/96

### 6 Point Standard Socket – Inch

ANSI B107.1

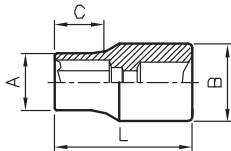

- Made of Chrome Vanadium Steel
- Chromed finish for exceptional resistance to rust.
- MaxiDrive™ gripping system: rounded gripping surface allows for 15% more torque and avoids rounding off fasteners, providing higher tenacity

1/4"	NEW SKU#	SKU#	SIZE	L mm	A mm	B mm	C mm	WEIGHT (g)	BOX/CTN
	N/A	86-025-1	9/32"	25.0	10.9	12.0	4.0	13	12/96



1/2"	NEW SKU#	SKU#	SIZE	L mm	A mm	B mm	C mm	WEIGHT (g)	BOX/CTN
	N/A	86-444-1	1/2"	38.0	19.0	21.8	10.0	52	6/96
	N/A	86-446-1	19/32"	38.0	21.8	21.8	14.3	55	6/96
	N/A	88-767-1	11/16"	38.0	24.7	23.0	14.3	72	6/96
	N/A	88-768-1	3/4"	38.0	26.3	24.0	20.0	76	6/96
	N/A	86-450-1	25/32"	38.0	27.7	25.0	20.0	80	4/96
	N/A	88-775-1	1 1/8"	43.0	37.8	31.0	23.0	150	2/96

## 6 Point Standard Socket – Metric

ISO 2725 / DIN 3124

- Made of Chrome Vanadium Steel
- Chromed finish for exceptional resistance to rust
- MaxiDrive™ gripping system: rounded gripping surface allows for 15% more torque and avoids rounding off fasteners, providing higher tenacity

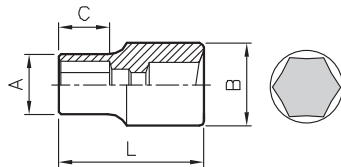

1/4"	NEW SKU#	SKU#	SIZE	L	A	B	C	WEIGHT	BOX/
				mm	mm	mm	mm	(g)	CTN
	STMT 72873-8B	86-101-1	4	25.0	6.9	12.0	3.6	10	12/96
	STMT 72874-8B	86-110-1	4.5	25.0	7.5	12.0	3.6	12	12/96
	STMT 72876-8B	86-111-1	5.5	25.0	8.8	12.0	4.2	12	12/96
	STMT 72882-8B	86-108-1	11	25.0	16.0	16.0	6.0	22	12/96
	STMT 72885-8B	86-114-1	14	25.0	19.7	19.7	8.4	38	12/96

3/8"	NEW SKU#	SKU#	SIZE	L	A	B	C	WEIGHT	BOX/
				mm	mm	mm	mm	(g)	CTN
	STMT 72930-8B	88-135-1	22	29.0	29.8	24.0	15.5	82	4/96
	STMT 72931-8B	88-136-1	23	29.0	30.7	25.0	15.5	85	4/96
	STMT 72932-8B	88-137-1	24	29.0	31.9	26.0	15.5	97	4/96

1/2"	NEW SKU#	SKU#	SIZE	L	A	B	C	WEIGHT	BOX/
				mm	mm	mm	mm	(g)	CTN
	STMT 72933-8B	86-508-1	8	38.0	13.0	21.8	9.0	43	6/96
	STMT 72934-8B	86-509-1	9	38.0	14.5	21.8	10.0	45	6/96
	STMT 72935-8B	86-510-1	10	38.0	15.5	21.8	10.0	47	6/96
	STMT 72936-8B	86-511-1	11	38.0	16.7	21.8	10.0	49	6/96
	STMT 72937-8B	86-512-1	12	38.0	18.0	21.8	10.0	51	6/96
	STMT 72938-8B	86-513-1	13	38.0	19.2	21.8	10.0	52	6/96
	STMT 72939-8B	86-514-1	14	38.0	20.5	21.8	10.0	52	6/96
	STMT 72940-8B	86-515-1	15	38.0	21.7	23.3	14.0	53	6/96
	STMT 72941-8B	88-738-1	16	38.0	22.5	23.3	14.3	62	6/96
	STMT 72942-8B	88-739-1	17	38.0	24.2	23.0	14.3	80	6/96
	STMT 72943-8B	88-740-1	18	38.0	24.7	23.0	15.3	82	6/96
	STMT 72944-8B	88-741-1	19	38.0	26.3	24.0	16.7	88	6/96
	STMT 72945-8B	88-742-1	20	38.0	27.7	25.0	17.3	96	6/96
	STMT 72946-8B	88-743-1	21	38.0	28.8	25.0	18.0	104	4/96
	STMT 72947-8B	88-744-1	22	40.0	29.8	26.0	18.0	113	4/96
	STMT 72948-8B	88-745-1	23	40.0	30.8	27.0	18.0	120	4/96
	STMT 72949-8B	88-746-1	24	40.0	31.8	27.0	18.0	126	4/96
	STMT 72950-8B	88-747-1	25	40.0	33.4	28.0	20.0	136	4/96
	STMT 72951-8B	88-748-1	26	43.0	34.8	29.0	20.0	140	4/96
	STMT 72952-8B	88-749-1	27	43.0	35.8	30.0	20.0	166	4/96
	STMT 72953-8B	88-750-1	28	43.0	37.8	31.0	20.0	172	4/96
	STMT 72954-8B	88-751-1	29	43.0	38.8	32.0	20.0	180	4/96
	STMT 72955-8B	88-752-1	30	43.0	39.8	33.0	20.0	191	2/96
	STMT 72956-8B	88-753-1	32	43.0	41.8	35.0	22.0	222	2/96
	STMT 72957-8B	86-196-1	34	45.5	43.8	35.0	25.0	254	2/96
	STMT 72958-8B	86-536-1	36	57.2	50.0	38.0	23.0	495	2/96

3/4"	SKU#	SIZE	L	A	B	C	WEIGHT	BOX/	
			mm	mm	mm	mm	(g)	CTN	
	STMT 89319-8B	89-319-1	19	49.5	30.0	35.0	14.0	210	4/48
	STMT 89322-8B	89-322-1	22	49.5	32.0	36.0	14.0	210	4/48
	STMT 89325-8B	89-325-1	25	50.0	37.0	36.0	21.0	210	4/48
	STMT 89333-8B	89-333-1	33	56.0	46.2	38.0	26.0	310	4/48
	STMT 89334-8B	89-334-1	34	56.0	47.2	38.0	26.0	340	6/48

1 MEASURING & LAYOUT TOOLS  
 2 CUTTING & HOLDING TOOLS  
 3 FASTENING TOOLS  
 4 STRIKING & STRUCK TOOLS  
 5 PAINTING & FINISHING TOOLS  
 6 MECHANIC TOOLS  
 7 TOOLS STORAGE

## 6 MECHANIC TOOLS

### 12 Point Standard Socket – Metric

ISO 2725 / DIN 3124

- Made of Chrome Vanadium Steel
- Chromed finish for exceptional resistance to rust
- MaxiDrive™ gripping system: rounded gripping surface allows for 15% more torque and avoids rounding off fasteners, providing higher tenacity

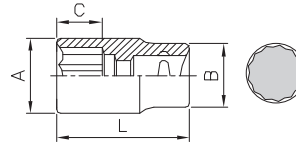

3/8"	NEW SKU#	SKU#	SIZE	L	A	B	C	WEIGHT	BOX/
				mm	mm	mm	mm	(g)	CTN
	STMT 72903-8B	86-349-1	14	25.7	19.5	19.5	9.0	40	6/96
	STMT 72904-8B	86-350-1	15	25.7	20.4	20.4	10.0	43	6/96
	STMT 72907-8B	88-146-1	18	29.0	24.2	20.0	15.5	56	6/96
	STMT 72909-8B	88-148-1	20	29.0	26.8	22.0	15.5	70	4/96
	STMT 72912-8B	88-151-1	23	29.0	30.7	25.0	15.5	82	4/96



3/4"	NEW SKU#	SKU#	SIZE	L	A	B	C	WEIGHT	BOX/
				mm	mm	mm	mm	(g)	CTN
	STMT 89644-8B	89-644-1	44	66.0	60.0	48.0	34.0	600	4/24
	STMT 89658-8B	89-658-1	58	76.0	76.5	48.0	42.0	1000	4/20

1/2"	NEW SKU#	SKU#	SIZE	L	A	B	C	WEIGHT	BOX/
				mm	mm	mm	mm	(g)	CTN
	STMT 72959-8B	86-540-1	8	38.0	13.0	21.8	9.0	43	6/96
	STMT 72960-8B	86-541-1	9	38.0	14.5	21.8	10.0	45	6/96
	STMT 72961-8B	86-542-1	10	38.0	15.5	21.8	10.0	47	6/96
	STMT 72962-8B	86-543-1	11	38.0	16.7	21.8	10.0	49	6/96
	STMT 72963-8B	86-544-1	12	38.0	18.0	21.8	10.0	51	6/96
	STMT 72964-8B	86-545-1	13	38.0	19.2	21.8	10.0	52	6/96
	STMT 72965-8B	86-546-1	14	38.0	20.5	21.8	10.0	52	6/96
	STMT 72966-8B	86-547-1	15	38.0	21.7	23.3	14.0	53	6/96
	STMT 72967-8B	88-788-1	16	38.0	22.5	23.3	14.3	62	6/96
	STMT 72968-8B	88-789-1	17	38.0	24.2	23.3	14.3	80	6/96
	STMT 72969-8B	88-790-1	18	38.0	24.7	23.3	15.3	82	6/96
	STMT 72970-8B	88-791-1	19	38.0	26.3	24.0	16.7	88	6/96
	STMT 72971-8B	88-792-1	20	38.0	27.7	25.0	17.3	96	4/96
	STMT 72972-8B	88-793-1	21	38.0	28.8	25.0	18.0	104	4/96
	STMT 72973-8B	88-794-1	22	40.0	29.8	26.0	18.0	113	4/96
	STMT 72974-8B	88-795-1	23	40.0	30.8	27.0	18.0	120	4/96
	STMT 72975-8B	88-796-1	24	40.0	31.8	27.0	18.0	126	4/96
	STMT 72976-8B	88-797-1	25	40.0	33.4	28.0	20.0	136	4/96
	STMT 72977-8B	88-798-1	26	43.0	34.8	29.0	20.0	140	4/96
	STMT 72978-8B	88-799-1	27	43.0	35.8	30.0	20.0	166	4/96
	STMT 72979-8B	88-800-1	28	43.0	37.8	31.0	20.0	172	4/96
	STMT 72980-8B	88-801-1	29	43.0	38.8	32.0	20.0	180	2/96
	STMT 72981-8B	88-802-1	30	43.0	39.8	33.0	20.0	191	2/96
	STMT 72982-8B	88-803-1	32	43.0	41.8	35.0	22.0	222	2/96
	STMT 72984-8B	88-187-1	36	57.2	50.0	38.0	23.0	495	2/24

## 12 Point Standard Socket – Inch

ANSI B107.1

- Made of Chrome Vanadium Steel
- Chromed finish for exceptional resistance to rust
- MaxiDrive™ gripping system: rounded gripping surface allows for 15% more torque and avoids rounding off fasteners, providing higher tenacity

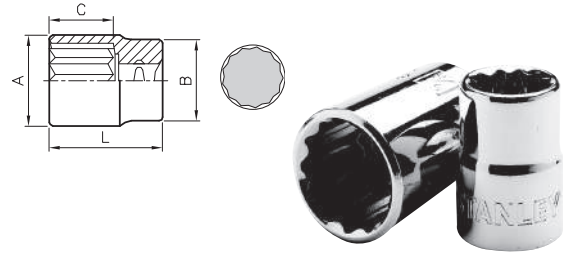

NEW SKU#	SKU#	SIZE	L	A	B	C	WEIGHT (g)	BOX/ CTN
			mm	mm	mm	mm		
N/A	86-260-1	1/4"	25.7	10.0	17.1	3.2	21	6/96
N/A	91-132-1	3/8"	25.7	14.2	17.1	5.0	24	6/96
N/A	91-151-1	1/2"	25.7	18.3	18.3	7.0	34	6/96
N/A	91-186-1	9/16"	25.7	19.5	19.5	9.0	38	6/96
N/A	88-179-1	13/16"	29.0	27.7	23.0	13.0	68	6/96
N/A	88-180-1	7/8"	29.0	29.5	24.0	13.0	75	6/96

NEW SKU#	SKU#	SIZE	L	A	B	C	WEIGHT (g)	BOX/ CTN
			mm	mm	mm	mm		
N/A	86-497-1	19/32"	38.0	21.8	21.8	14.3	55	6/96

NEW SKU#	SKU#	SIZE	L	A	B	C	WEIGHT (g)	BOX/ CTN
			mm	mm	mm	mm		
STMT 89662-8B	89-662-1	13/16"	49.5	31.0	35.0	14.0	200	4/48
STMT 89663-8B	89-663-1	7/8"	49.5	32.0	36.0	14.0	210	4/48
STMT 89664-8B	89-664-1	15/16"	49.5	34.0	36.0	15.0	220	4/48
STMT 89666-8B	89-666-1	1-1/16"	52.0	38.4	36.0	24.0	220	4/48
STMT 89667-8B	89-667-1	1-1/8"	52.0	40.0	38.0	24.0	240	4/48
STMT 89668-8B	89-668-1	1-3/16"	54.0	42.3	38.0	25.0	280	4/48
STMT 89669-8B	89-669-1	1-1/4"	56.0	44.2	38.0	26.0	280	4/48
STMT 89671-8B	89-671-1	1-3/8"	58.0	48.2	42.0	28.0	360	4/24
STMT 89672-8B	89-672-1	1-7/16"	58.0	50.2	42.0	28.0	380	4/24
STMT 89674-8B	89-674-1	1-5/8"	64.0	56.0	45.0	32.0	520	4/24
STMT 89675-8B	89-675-1	1-11/16"	65.0	58.0	46.0	33.0	540	4/24
STMT 89676-8B	89-676-1	1-3/4"	66.0	60.0	48.0	34.0	580	4/24
STMT 89677-8B	89-677-1	1-13/16"	68.0	62.0	48.0	35.0	640	4/24

## 6 Point Deep Socket – Metric

ISO 2725 / DIN 3124

- Made of Chrome Vanadium Steel
- Chromed finish for exceptional resistance to rust
- MaxiDrive™ gripping system: rounded gripping surface allows for 15% more torque and avoids rounding off fasteners, providing higher tenacity

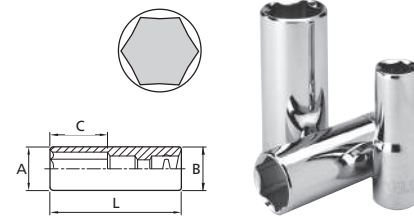

NEW SKU#	SKU#	SIZE	L	A	B	C	WEIGHT (g)	BOX/ CTN
			mm	mm	mm	mm		
STMT 73271-8B	88-826-1	18	56.0	24.2	23.0	20.0	125	6/96
STMT 73273-8B	88-827-1	20	63.5	26.8	25.0	22.0	140	6/96
STMT 73275-8B	88-829-1	22	63.5	29.5	27.0	22.0	165	6/96

NEW SKU#	SKU#	SIZE	L	A	B	C	WEIGHT (g)	BOX/ CTN
			mm	mm	mm	mm		
STMT 73324-8B	93-525-1	10	79.0	15.5	22.0	17.0	124	6/96
STMT 73325-8B	93-526-1	11	79.0	16.7	22.0	18.0	129	6/96
STMT 73326-8B	93-527-1	12	79.0	18.0	22.0	19.0	129	6/96
STMT 73327-8B	93-528-1	13	79.0	19.2	22.0	21.0	134	6/96
STMT 73328-8B	93-529-1	14	79.0	20.5	22.0	25.0	134	6/96
STMT 73329-8B	93-530-1	15	79.0	21.5	22.0	28.0	134	6/96
STMT 73330-8B	93-531-1	16	79.0	22.5	22.5	31.0	149	6/96
STMT 73331-8B	93-532-1	17	79.0	24.2	24.2	34.0	154	6/96
STMT 73332-8B	93-533-1	18	79.0	25.4	25.4	34.0	164	6/96
STMT 73333-8B	93-534-1	19	79.0	26.7	26.7	34.0	189	6/96
STMT 73334-8B	93-535-1	21	79.0	27.8	27.8	34.0	194	4/32
STMT 73335-8B	93-536-1	22	79.0	27.8	27.8	34.0	199	4/32



## 12-Point Deep Socket – Metric

DIN 3124

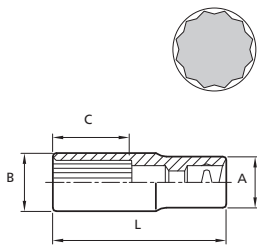

- Made of Chrome Vanadium Steel
- Chromed finish for exceptional resistance to rust
- MaxiDrive™ gripping system: rounded gripping surface allows for 15% more torque and avoids rounding off fasteners, providing higher tenacity

1/2"	NEW SKU#	SKU#	SIZE	L mm	A mm	B mm	C mm	WEIGHT (g)	BOX/CTN
	STMT 73351-8B	86-428-1	20	79.0	27.8	27.8	34.0	195	6/96
	STMT 73359-8B	86-436-1	28	79.0	37.8	33.0	34.0	320	4/96

3/8"	NEW SKU#	SKU#	SIZE	L mm	A mm	B mm	C mm	WEIGHT (g)	BOX/CTN
	STMT 73277-8B	86-339-1	9	45.5	13.1	16.5	14.0	55	6/96
	STMT 73280-8B	86-364-1	12	45.5	17.1	17.1	18.0	75	6/96
	STMT 73282-8B	86-366-1	14	50.0	19.5	19.5	18.0	95	6/96
	STMT 73283-8B	86-367-1	15	53.0	20.4	20.4	20.0	100	6/96
	STMT 73285-8B	86-369-1	17	56.0	23.3	23.3	20.0	120	6/96
	STMT 73286-8B	86-370-1	18	56.0	24.2	23.0	20.0	125	6/96

## 12-Point Deep Socket – Inch

ANSI B107.1

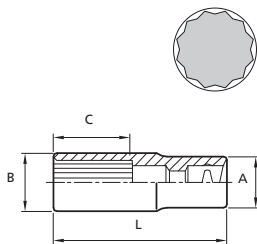

- Made of Chrome Vanadium Steel
- Chromed finish for exceptional resistance to rust
- MaxiDrive™ gripping system: rounded gripping surface allows for 15% more torque and avoids rounding off fasteners, providing higher tenacity

3/8"	NEW SKU#	SKU#	SIZE	L mm	A mm	B mm	C mm	WEIGHT (g)	BOX/CTN
	N/A	91-287-1	7/16"	45.5	16.5	16.5	17.0	50	6/96
	N/A	91-289-1	9/16"	50.0	19.5	19.5	18.0	72	6/96
	N/A	91-297-1	11/16"	56.0	24.2	24.2	20.0	125	6/96

1/2"	NEW SKU#	SKU#	SIZE	L mm	A mm	B mm	C mm	WEIGHT (g)	BOX/CTN
	N/A	86-491-1	1-1/8"	79.0	37.8	37.8	33.0	350	4/96

## Hex Bit Socket – Inch

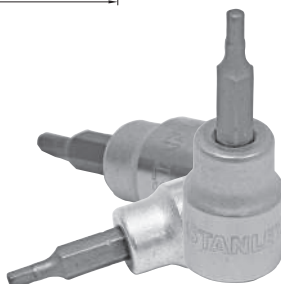
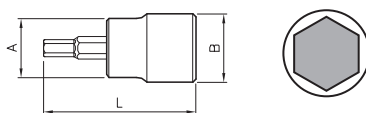

- Made of Chrome Vanadium Steel
- Chromed finish for exceptional resistance to rust
- MaxiDrive™ gripping system: rounded gripping surface allows for 15% more torque and avoids rounding off fasteners, providing higher tenacity

3/8"	NEW SKU#	SKU#	SIZE	L mm	A mm	B mm	WEIGHT (g)	BOX/CTN
	N/A	86-387-1	1/8"	49.5	8.0	17.9	36	6/96
	N/A	86-392-1	5/16"	49.5	16.0	17.9	40	6/96

1/2"	NEW SKU#	SKU#	SIZE	L mm	A mm	B mm	WEIGHT (g)	BOX/CTN
	4-89-180	89-180-1	5/16"	55.0	16.0	22.0	74	6/144

## Torx® Bit Socket

- Made of Chrome Vanadium Steel
- Chromed finish for exceptional resistance to rust
- MaxiDrive™ gripping system: rounded gripping surface allows for 15% more torque and avoids rounding off fasteners, providing higher tenacity

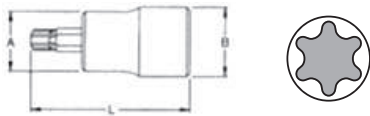

1/4"	NEW SKU#	SKU#	SIZE	L mm	A mm	B mm	BOX/ CTN
	STMT 73244-8B	91-576-1	T-08	32.0	11.0	12.0	6/144
STMT 73246-8B	91-577-1	T-10	32.0	11.0	12.0	6/144	
STMT 73247-8B	91-578-1	T-15	32.0	11.0	12.0	6/144	
STMT 73248-8B	91-579-1	T-20	32.0	11.0	12.0	6/144	
STMT 73249-8B	91-580-1	T-25	32.0	11.0	12.0	6/144	
STMT 73252-8B	91-583-1	T-40	32.0	11.0	12.0	6/144	



3/8"	NEW SKU#	SKU#	SIZE	L mm	A mm	B mm	BOX/ CTN
	STMT 73314-8B	87-404-1	T-10	49.5	8.0	17.9	6/96
	STMT 73315-8B	87-141-1	T-15	49.5	10.0	17.9	6/96
	STMT 73316-8B	87-142-1	T-20	49.5	12.0	17.9	6/96
	STMT 73317-8B	87-143-1	T-25	49.5	14.0	17.9	6/96
	STMT 73319-8B	87-144-1	T-30	49.5	16.0	17.9	6/96
	STMT 73320-8B	87-145-1	T-40	49.5	16.0	17.9	6/96
	STMT 73321-8B	87-146-1	T-45	49.5	16.0	17.9	6/96
	STMT 73322-8B	87-147-1	T-50	49.5	17.0	17.9	6/96
STMT 73323-8B	87-407-1	T-55	49.5	17.0	17.9	6/96	

1/2"	NEW SKU#	SKU#	SIZE	L mm	A mm	B mm	BOX/ CTN
	STMT 73391-8B	89-217-1	T-27	55.0	14.0	22.0	6/96

## Phillips® Bit Socket

- Made of Chrome Vanadium Steel
- Chromed finish for exceptional resistance to rust
- MaxiDrive™ gripping system: rounded gripping surface allows for 15% more torque and avoids rounding off fasteners, providing higher tenacity

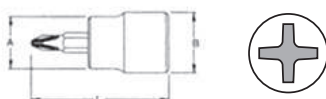

3/8"	NEW SKU#	SKU#	SIZE	L mm	A mm	B mm	BOX/ CTN
	STMT 73305-8B	86-335-1	1 PT	49.5	14.0	17.9	6/144
	STMT 73306-8B	86-177-1	2 PT	49.5	14.0	17.9	6/144
	STMT 73307-8B	86-336-1	3 PT	49.5	14.0	17.9	6/96
	STMT 73308-8B	86-178-1	4 PT	49.5	14.0	17.9	6/144

## 6 MECHANIC TOOLS



### Slotted Bit Socket – Metric

ISO 2380 / DIN 5264

- Made of Chrome Vanadium Steel
- Chromed finish for exceptional resistance to rust
- MaxiDrive™ gripping system: rounded gripping surface allows for 15% more torque and avoids rounding off fasteners, providing higher tenacity

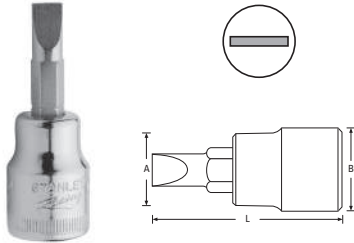

	NEW SKU#	SKU#	SIZE	L mm	A mm	B mm	WEIGHT (g)	BOX/CTN
1/4"	STMT 73233-8B	86-745-1	4	32.0	11.0	12.0	13	6/144
	STMT 73234-8B	86-743-1	5.5	32.0	11.0	12.0	13	6/144
	STMT 73235-8B	86-747-1	7	32.0	11.0	12.0	14	6/144

	NEW SKU#	SKU#	SIZE	L mm	A mm	B mm	WEIGHT (g)	BOX/CTN
1/2"	4-89-208	89-208-1	6.5	55.0	16.0	22.0	74	6/144
	4-89-209	89-209-1	8	55.0	16.0	22.0	74	6/144

### Pozidriv® Bit Socket

- Made of Chrome Vanadium Steel
- Chromed finish for exceptional resistance to rust
- MaxiDrive™ gripping system: rounded gripping surface allows for 15% more torque and avoids rounding off fasteners, providing higher tenacity

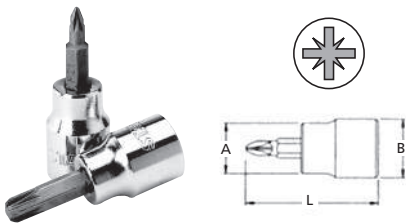

	NEW SKU#	SKU#	SIZE	L mm	A mm	B mm	WEIGHT (g)	BOX/CTN
3/8"	STMT 73309-8B	89-171-1	1 PT	49.5	14.0	17.9	37	6/144
	STMT 73311-8B	89-173-1	3 PT	49.5	14.0	17.9	38	6/144
	STMT 73312-8B	89-174-1	4 PT	49.5	14.0	17.9	38	6/144

### T-handle Fixed Head 6 Point Sockets

- Made of Chrome Vanadium Steel
- Chromed finish for exceptional resistance to rust

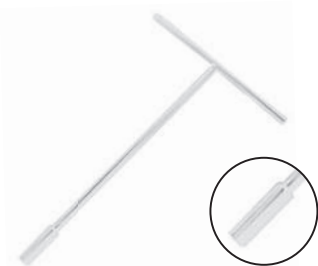

NEW SKU#	SKU#	DESCRIPTION	BOX/CTN
STMT 93302-8	93-302-1	T-Handle 6pt Socket 08mm x L300mm	50/50
STMT 93304-8	93-304-1	T-Handle 6pt Socket 10mm x L300mm	50/50
STMT 93306-8	93-306-1	T-Handle 6pt Socket 12mm x L300mm	50/50
STMT 93308-8	93-308-1	T-Handle 6pt Socket 14mm x L300mm	40/40



## 6 Point Standard Impact Sockets

- Chrome Molybdenum for stronger torque

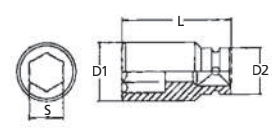
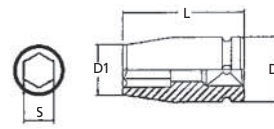
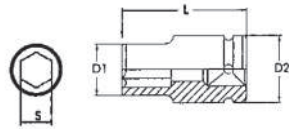

	NEW SKU#	SKU#	SIZE mm	D1	D2	L1	TYPE	BOX/CTN
3/4"	STMT 89395-8B	89-395-1	17	30.0	44.0	51	A	6/48
	STMT 89396-8B	89-396-1	18	31.0	44.0	51	A	6/48
	STMT 89398-8B	89-398-1	20	33.5	44.0	51	A	6/48
	STMT 89403-8B	89-403-1	25	40.0	44.0	51	A	6/48
	STMT 89406-8B	89-406-1	28	44.0	44.0	51	B	6/48
	STMT 89419-8B	89-419-1	43	62.5	44.0	62	C	6/24
	STMT 89421-8B	89-421-1	46	66.0	44.0	62	C	6/24
	STMT 89424-8B	89-424-1	52	73.0	54.0	71	C	4/12
STMT 89428-8B	89-428-1	58	81.0	54.0	73	C	4/12	

	NEW SKU#	SKU#	SIZE mm	D1	D2	L1	TYPE	BOX/CTN
1/2"	STMT 89438-8B	89-438-1	11	18.5	25	38	A	10/200
	STMT 89444-8B	89-444-1	17	26.0	30	38	B	10/180
	STMT 89447-8B	89-447-1	20	30.0	30	38	B	10/180
	STMT 89449-8B	89-449-1	22	32.0	30	38	C	10/150
	STMT 89450-8B	89-450-1	23	34.0	30	38	C	10/150
	STMT 89451-8B	89-451-1	24	34.0	30	38	C	10/150
	STMT 89457-8B	89-457-1	31	42.0	30	42	C	6/90
	STMT 89458-8B	89-458-1	32	44.0	30	44	C	6/90

## Double Open End Wrench Set



- Made of Chrome Vanadium Steel
- Ends are slanted 15° for quick operation
- Two sizes per wrench
- Comprehensive set of open end wrench for the most common sizes
- Anti-slip feature

NEW SKU#	SKU#	CONTENTS	WEIGHT (g)	BOX/CTN
N/A	87-716-1 6pc	"Slimline" wrench: (Metric) 6 x 7, 8 x 9, 10 x 11, 12 x 13, 14 x 15, 16 x 17 Heavy-duty nylon pouch	590	1/30
N/A	87-718-1 8 pc	"Slimline" wrench: (Metric) 6 x 7, 8 x 9, 10 x 11, 12 x 13, 14 x 15, 16 x 17, 18 x 19, 20 x 22mm Heavy-duty nylon pouch Inner box	590	1/12

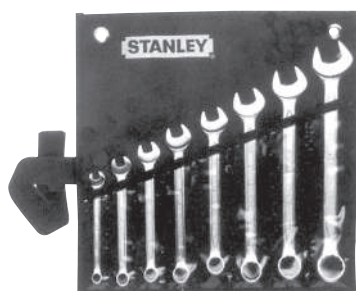

### Slimline 8 Piece Combination Wrench Set

- Made of Chrome Vanadium Steel
- Both the open ended head and the ring are angled at 15° for optimum accessibility
- Nickel chrome plating protects against corrosion
- Slim pattern
- MaxiDrive™ and anti-slip open ended jaw shape maintains grip on fastener with only slight rotational pressure
- Anti-slip feature

NEW SKU#	SKU#	CONTENTS	WEIGHT (g)	BOX/CTN
N/A	87-011-1	"Slimline" wrench: 8, 10, 11, 13, 14, 17, 19, 22mm Heavy-duty nylon pouch Inner box	920	20/20

### Slimline 9 Piece Combination Wrench Set

ISO 3318 / DIN 3113

- Made of Chrome Vanadium Steel
- Both the open ended head and the ring are angled at 15° for optimum accessibility
- Nickel chrome plating protects against corrosion
- Slim pattern
- MaxiDrive™ and anti-slip open ended jaw shape maintains grip on fastener with only slight rotational pressure
- Anti-slip feature

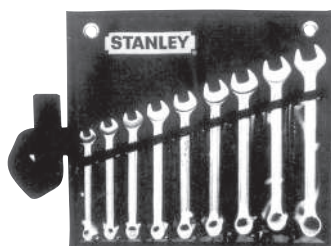

NEW SKU#	SKU#	CONTENTS	WEIGHT (g)	BOX/CTN
N/A	87-034-1	"Slimline" wrench: 8, 9, 10, 11, 12, 13, 14, 15, 17mm Heavy-duty nylon pouch Inner box	910	20/20
N/A	87-033-1	"Slimline" wrench: 10, 11, 12, 13, 14, 15, 16, 17, 19mm Heavy-duty nylon pouch Inner box	1490	16/16

## Slimline 14 Piece Combination Wrench Set

ISO 3318 / DIN 3113

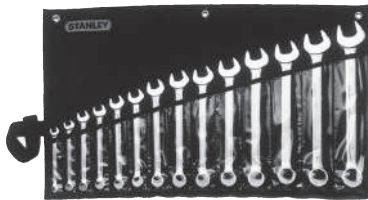

- Made of Chrome Vanadium Steel
- Both the open ended head and the ring are angled at 15° for optimum accessibility
- Nickel chrome plating protects against corrosion
- Slim pat tern
- MaxiDrive™ and anti-slip open ended jaw shape maintains grip on fastener with only slight rotational pressure
- Anti-slip feature

NEW SKU#	SKU#	CONTENTS	WEIGHT (g)	BOX/CTN
N/A	87-036-1	"Slimline" wrench: 8, 9, 10, 11, 12, 13, 14, 15, 16, 17, 19, 21, 22, 24mm Heavy-duty nylon pouch Inner box	3600	10/10
N/A	87-038-1	"Slimline" wrench: 10, 11, 12, 13, 14, 17, 19, 21, 22, 23, 24, 26, 30, 32mm Heavy-duty nylon pouch Inner box	2300	1/6
N/A	87-709-1	"Slimline" wrench: 3/8", 7/16", 1/2", 9/16", 5/8", 11/16", 3/4", 13/16", 7/8", 15/16", 1", 1 1/16", 1 1/8", 1 1/4" Heavy-duty nylon pouch Inner box	10400	1/6

## 75° Offset Ring End Wrench Set

ISO 1711 / DIN 838 / 1085



- Double ring wrench chrome vanadium steel
- MaxiDrive™ Plus profile - Attacks on the sides, not the corners of the nut or bolt
- Twelve-edged head for optimal support of hexagonal and square nuts
- Polished and chrome-plated finish for excellent protection
- Heads to 70° for greater access in tight spaces
- Powerful and safe working
- Anti-slip feature

NEW SKU#	SKU#	CONTENTS	WEIGHT (g)	BOX/CTN
N/A	87-576-1 8 pc	"Slimline" wrench: (Metric) 6 x 7, 8 x 9, 10 x 11, 12 x 13, 14 x 15, 16 x 17, 18 x 19, 20 x 22mm Inner box	1400	12/12
87-617-3	87-617-1 10 pc	"Slimline" wrench: (Metric) 6 x 7, 8 x 9, 10 x 11, 12 x 13, 14 x 15, 16 x 17, 18 x 19, 20 x 22, 21 x 23, 24 x 27mm Inner box	2200	10/10

1 MEASURING & LAYOUT TOOLS

2 CUTTING & HOLDING TOOLS

3 FASTENING TOOLS

4 STRIKING & SHOCK TOOLS

5 PAINTING & FINISHING TOOLS

6 MECHANIC TOOLS

7 TOOLS STORAGE

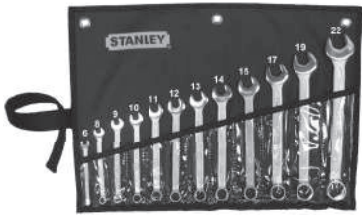

## 12-Piece Slimline Combination Wrench Set - Metric

- Made of Chrome Vanadium Steel
- Both the open ended head and the ring are angled at 15° for optimum accessibility
- Nickel chrome plating protects against corrosion
- Slim pattern
- MaxiDrive™ and anti-slip open ended jaw shape maintains grip on fastener with only slight rotational pressure
- Anti-slip feature

		CONTENTS									
NEW SKU#	SKU#	SIZE	L mm	A mm	B mm	C mm	D mm	H mm	T mm	WEIGHT (g)	BOX / CTN
95 - 094	N/A	6	100.0	4.7	10.1	4.0	15.5	7.1	2.7	15	1/10
		8	120.0	5.5	12.8	4.5	19.2	8.4	3.0	23	1/10
		9	130.0	5.9	14.2	4.5	21.2	9.0	3.3	33	1/10
		10	140.0	6.5	15.6	5.0	23.2	9.6	3.5	38	1/10
		11	150.0	6.9	16.9	5.4	25.3	10.4	3.7	50	1/10
		12	160.0	7.3	18.3	5.5	27.2	11.3	3.9	58	1/10
		13	170.0	7.8	19.7	5.9	29.4	12.1	4.1	66	1/10
		14	180.0	8.3	21.2	6.2	31.5	12.9	4.4	88	1/10
		15	190.0	8.6	22.5	6.4	33.2	13.5	4.6	96	1/10
		17	210.0	9.3	25.3	6.9	36.5	14.6	5.0	124	1/10
		19	230.0	10.5	28.1	7.4	40.7	15.9	5.4	169	1/10
		22	260.0	11.5	32.6	8.2	46.9	18.0	5.8	212	1/10

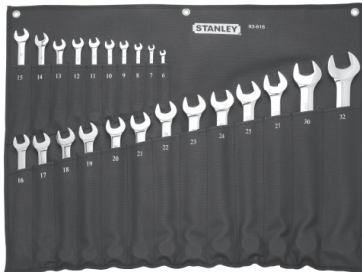

## Mirror Finish Extra Long 23 Piece Combination Wrench Set

- Chrome Vanadium steel forging for durability and high torque
- Full polish chrome plating for anti-corrosion protection and easy cleaning
- Wrenches are designed to meet or exceed ANSI specifications

NEW SKU#	Description	Weight (g)	BOX/CTN
93-616	WRENCH SET COMB SL 23PC MET (Mirror Finish) 6, 7, 8, 9, 10, 11, 12, 13, 14, 15, 16, 17, 18, 19, 20, 21, 22, 23, 24, 25, 27, 30, 32)		

## 75° Offset Ring End Wrench

ISO 1711 / DIN 838/ 1085

- Double ring wrench chrome vanadium steel
- MaxiDrive™ Plus profile - Attacks on the sides, not the corners of the nut or bolt
- Twelve-edged head for optimal support of hexagonal and square nuts
- Polished and chrome-plated finish for excellent protection
- Heads to 70° for greater access in tight spaces
- Powerful and safe working

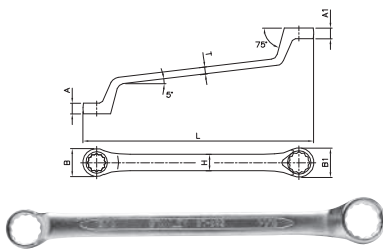

NEW SKU#	SKU#	SIZE	L mm	A mm	A1 mm	B mm	B1 mm	H mm	T mm	BOX/CTN
N/A	87-801-1	6x7	168.0	5.7	6.3	10.7	12.2	8.0	4.1	6/60
N/A	87-802-1	8x9	183.0	6.6	7.0	13.6	15.1	9.3	4.5	6/24
N/A	87-803-1	10x11	198.0	7.4	7.7	16.6	18.0	11.3	4.9	6/24
N/A	87-804-1	12x13	217.0	8.1	8.4	19.5	20.9	13.0	5.4	6/72
N/A	87-805-1	14x15	239.0	8.8	9.1	22.4	23.7	13.8	5.7	6/48
N/A	87-806-1	16x17	260.0	9.5	9.8	25.3	26.7	15.0	6.2	6/48
N/A	87-807-1	18x19	292.0	10.1	10.4	28.2	29.7	16.0	6.6	6/48
N/A	87-808-1	20x22	318.0	10.9	11.4	31.1	34.0	17.6	7.1	4/24
N/A	87-809-1	21x23	326.5	11.2	11.6	32.6	35.5	18.0	7.6	4/24
N/A	87-810-1	24x27	329.0	12.4	13.4	36.9	41.0	20.0	8.1	4/24
N/A	87-812-1	30x32	362.0	14.4	15.2	45.5	48.5	21.5	9.0	2/16

NEW SKU#	SKU#	SIZE	L mm	A mm	A1 mm	B mm	B1 mm	H mm	T mm	BOX/ CTN
N/A	87-687-1	1/4"x5/16"	168.0	5.6	6.3	10.7	12.2	8.0	4.1	6/24
N/A	87-689-1	3/8"x7/16"	198.0	7.4	7.7	16.6	18.0	11.3	4.9	6/24
N/A	87-691-1	9/16"x5/8"	239.0	8.8	9.1	22.4	23.7	13.8	5.7	6/24
N/A	87-692-1	5/8"x11/16"	260.0	9.5	9.8	25.3	26.7	15.0	6.2	6/24
N/A	87-693-1	11/16"x3/4"	292.0	10.1	10.4	28.2	29.7	16.0	6.6	6/24
N/A	87-694-1	13/16"x7/8"	318.0	10.9	11.4	31.1	34.0	17.6	7.1	4/24

## 40° Offset Ring Wrenches

ISO 1711 / DIN 838

- Double ring wrench chrome vanadium steel
- Maxi Drive Plus profile - Attacks on the sides, not the corners of the nut or bolt
- Twelve-edged head for optimal support of hexagonal and square nuts
- Polished and chrome-plated finish for excellent protection
- Powerful and safe working

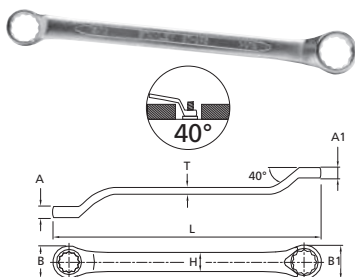

NEW SKU#	SKU#	SIZE	L mm	A mm	A1 mm	B mm	B1 mm	H mm	T mm	BOX/ CTN
STMT 72858-8B	86-127	8x9	170	6.0	5.5	16.5	14.5	8.8	4.0	50/250
STMT 72859-8B	93-621	8x10	170	6.0	5.5	16.5	14.5	8.8	4.0	50/250
STMT 72860-8B	93-622	10x12	195	7.0	6.5	19.2	17.2	9.8	4.3	50/250
STMT 72861-8B	93-623	11x13	206	8.0	7.5	22.0	20.0	11.8	5.1	50/250
STMT 72862-8B	93-624	12x14	206	8.0	7.5	22.0	20.0	11.8	5.1	50/250
STMT 72864-8B	93-625	14x17	237	9.5	9.0	26.0	24.0	13.8	5.6	20/100
STMT 72866-8B	93-626	17x19	270	11.0	10.5	29.5	28.0	15.8	7.3	20/100
STMT 72868-8B	93-627	19x21	292	11.7	11.2	32.5	29.0	16.6	7.6	20/100
STMT 72869-8B	93-628	22x24	346	12.5	12.0	34.8	32.8	18.4	8.0	25/50
STMT 72870-8B	95-880	24x27	410	15.5	15.0	42.7	38.2	21.8	9.3	5/20

## 6 MECHANIC TOOLS

### Slimline Combination Wrench

ISO 3318 / DIN 3113

- Made of Chrome Vanadium Steel
- Both the open ended head and the ring are angled at 15° for optimum accessibility
- Nickel chrome plating protects against corrosion
- Slim pattern
- MaxiDrive™ and anti-slip open ended jaw shape maintains grip on fastener with only slight rotational pressure
- Anti-slip feature

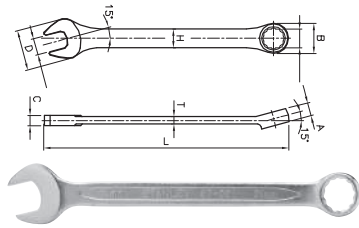

SKU#	SIZE	L mm	A mm	B mm	C mm	D mm	H mm	T mm	BOX/CTN
87-665-1	9/16"	180.0	8.3	21.2	6.2	31.5	12.9	4.4	6/54
87-666-1	5/8"	200.0	8.9	24.0	6.7	34.7	13.9	4.8	6/54
87-667-1	11/16"	210.0	9.3	25.3	6.9	36.5	14.6	5.0	6/54
87-668-1	3/4"	230.0	10.5	28.1	7.4	40.7	15.9	5.4	6/60

SKU#	SIZE	L mm	A mm	B mm	C mm	D mm	H mm	T mm	BOX/CTN
87-066-1	6	100.0	4.7	10.1	4.0	15.5	7.1	2.7	6/72
87-057-1	7	110.0	5.0	11.5	4.0	17.0	7.8	2.8	6/90
87-058-1	8	120.0	5.5	12.8	4.5	19.2	8.4	3.0	6/90
87-069-1	9	130.0	5.9	14.2	4.5	21.2	9.0	3.3	6/72
87-070-1	10	140.0	6.5	15.6	5.0	23.2	9.6	3.5	6/72
87-071-1	11	150.0	6.9	16.9	5.4	25.3	10.4	3.7	6/72
87-072-1	12	160.0	7.3	18.3	5.5	27.2	11.3	3.9	6/72
87-073-1	13	170.0	7.8	19.7	5.9	29.4	12.1	4.1	6/54
87-074-1	14	180.0	8.3	21.2	6.2	31.5	12.9	4.4	6/54
87-075-1	15	190.0	8.6	22.5	6.4	33.2	13.5	4.6	6/54
87-076-1	16	200.0	8.9	24.0	6.7	34.7	13.9	4.8	6/54
87-077-1	17	210.0	9.3	25.3	6.9	36.5	14.6	5.0	6/54
87-078-1	18	220.0	9.9	26.8	7.2	38.7	15.3	5.2	6/54
87-079-1	19	230.0	10.5	28.1	7.4	40.7	15.9	5.4	6/60
87-080-1	20	240.0	10.9	29.7	7.7	43.1	16.8	5.6	4/24
87-081-1	21	250.0	11.3	31.3	8.0	44.8	17.3	5.7	4/24
87-082-1	22	260.0	11.5	32.6	8.2	46.9	18.0	5.8	4/24
87-083-1	23	270.0	11.8	34.2	8.4	48.3	18.7	5.9	4/24
87-084-1	24	280.0	12.1	35.5	8.7	50.4	19.5	6.0	4/24
87-085-1	25	290.0	12.5	36.9	8.9	52.0	20.1	6.2	4/24
87-086-1	26	300.0	12.8	38.2	9.2	53.6	21.0	6.4	4/24
87-087-1	27	310.0	13.1	39.6	9.4	55.7	21.8	6.6	4/24
87-089-1	29	330.0	13.5	42.3	9.9	59.7	23.3	7.0	2/12
87-090-1	30	340.0	13.7	43.7	10.1	61.8	23.9	7.1	2/12
87-092-1	32	360.0	14.3	46.4	10.4	65.8	24.8	7.3	2/12
87-263-22	33	408.0	14.5	11.0	48.0	62	23.0	11.0	1/30
87-264-22	34	408.0	14.5	11.0	48.0	62	23.0	11.0	1/25
87-265-22	35	430.0	17.0	15.0	56.5	70	26.0	12.0	1/25
87-266-22	36	430.0	17.0	15.0	56.5	70	26.0	12.0	1/25
87-268-22	38	460.0	17.0	15.0	56.5	70	26.0	12.0	1/20
87-271-22	41	490.0	19.0	16.5	65.0	83	29.0	14.0	1/15
87-272-22	42	490.0	19.0	16.5	65.0	83	29.0	14.0	1/15
87-276-22	46	540.0	19.0	16.5	65.0	83	29.0	14.0	1/15
87-278-22	48	563.0	24.0	19.0	72.5	94	35.0	15.0	1/10
87-280-22	50	587.0	24.0	19.0	72.5	94	35.0	15.0	1/10

### Open End Wrench

Metric obtains DIN 3110 / ISO 10102

Inch obtains DIN 1085 / ISO 1711

- Made of Chrome Vanadium Steel
- Ends are slanted 15° for quick operation
- Two sizes per wrench
- Anti-slip feature

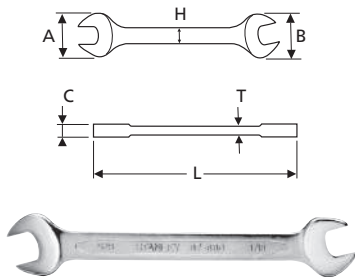

NEW SKU#	SKU#	SIZE	L mm	A mm	B mm	C mm	H mm	T mm	WEIGHT (g)	BOX/CTN
N/A	87-706-1	15/16"x1"	255.0	50.8	56.8	7.9	21.4	5.3	270	4/32

## Double Flex Socket Wrenches - Metric

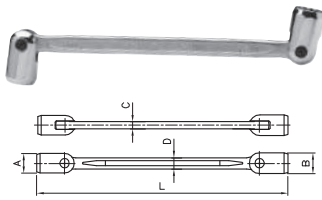

NEW SKU#	SKU#	SIZE	L mm	A mm	B mm	C mm	D mm	WEIGHT (g)	BOX / CTN
N/A	89-780-1	8x9	174.1	12.5	13.8	4.3	7.5	65	6/90
N/A	89-781-1	10x11	201.3	14.5	15.6	5.5	8.7	100	6/72
N/A	89-782-1	12x13	218.8	17.2	18.2	6.0	9.7	140	6/72
N/A	89-783-1	14x15	237.1	20.0	22.0	6.5	10.4	210	6/60
N/A	89-784-1	16x17	259.0	23.0	24.2	8.0	12.0	320	6/48
N/A	89-785-1	18x19	275.0	25.3	26.2	9.0	14.0	370	6/48

## Flare Nut Wrenches

ANSI B107.6

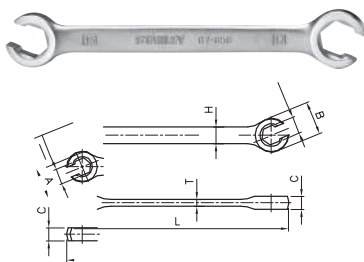

NEW SKU#	SKU#	SIZE	L mm	A mm	B mm	C mm	H mm	T mm	WEIGHT (g)	BOX/ CTN
N/A	87-392-1	8x10	146.5	18.4	21.4	7.5	9.8	4.0	60	6/72
N/A	87-393-1	12x14	178.6	25.0	27.4	10.0	13.1	5.7	115	6/48

NEW SKU#	SKU#	SIZE	L mm	A mm	B mm	C mm	H mm	T mm	WEIGHT (g)	BOX/ CTN
N/A	87-850-1	3/8"x7/16"	152.4	21.4	23.0	7.9	10.7	4.3	65	6/72
N/A	87-851-1	1/2"x9/16"	178.6	25.0	27.4	10.0	13.1	5.7	115	6/60
N/A	87-853-1	3/4"x7/8"	207.0	34.2	38.2	13.8	17.0	7.4	215	6/24

## Reversible Geared Wrench - Metric

- 13° offset head angle provides finger and obstruction clearance
- Higher efficiency and ergonomic
- Provides ability to work in tight and hard to access areas
- Works with just 5° of sweep to turn a fastener (Traditional wrenches need 30°)
- Easy-access reversing switch
- Best used in automotive garages



NEW SKU#	SKU#	SIZE	B mm	D mm	G mm	I mm	T mm	J mm	L mm	WEIGHT (kg)	BOX/ CTN
STMT89943-8B	85-939-2	18	37.6	15.9	32.6	8.2	5.3	10.7	237	0.197	6/48

## Locking Flex-Head Geared Wrench - Metric

- Higher efficiency and ergonomic
- Provides ability to work in tight and hard to access areas
- Work with just 5° swing
- Ratcheting head rotates 180°
- Locks at desired working angle
- Smaller profile than competitor's models for better access to fasteners
- Best use in automotive garages

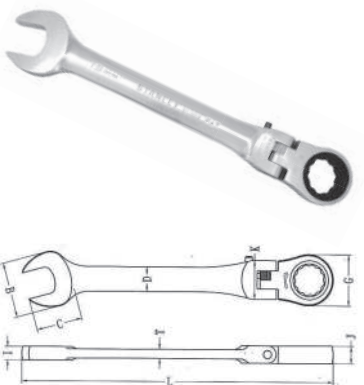

NEW SKU#	SKU#	SIZE	B mm	C mm	D mm	G mm	I mm	T mm	J mm	L mm	K mm	Weight (kg)	BOX/ CTN
N/A	91-891-2-22	11	23	20	10	21.5	5.4	3.8	7.7	141.0	17.2	0.087	10/100

## 6 MECHANIC TOOLS



### 3/4" Impact Wrench 1492Nm

- End cap slider-guide trigger - designed for easy operation
- Improved throttle valve seat - allows easier maintenance
- Composite grip - super lightweight, ergonomic design isolating from the coldness
- Improved air inlet - effectively reduces the damage and loss of thread
- Three-speed control for forward and one-speed full output for reverse direction
- Patented three-way air inlet function - increase 10% and more at horsepower delivery than same level tools
- **Service Kit Content :**  
O-ring 8, Spring 2, Steel ball 1, Ball-bearing 2, Rotor blade 6, Gasket 2, Socket retainer 1, Muffler element 1

SKU#	SQUARE DRIVE inch	STANDARD BOLT Size inch	FREE SPEED RPM	MAX. TORQUE Nm	OVERALL LENGTH mm	AIR INLET PT	AIR HOSE I.D	AVG. AIR CONSUMPTION cfm (l/min)	NOISE LEVEL dB	NET WEIGHT (kg)
STMT97134-8	3/4	1	3,600	1492	257	3/8	1/2	4.0 CFM	96.5	5.72



### 1/2" Impact Wrench 610Nm

- End cap slider-guide trigger - designed for easy operation
- Improved throttle valve seat - allows easier maintenance
- Composite grip - super lightweight, ergonomic design isolating from the coldness
- Improved air inlet - effectively reduces the damage and loss of thread
- Three-speed control for forward and one-speed full output for reverse direction
- Patented three-way air inlet function - increase 10% and more at horsepower delivery than same level tools
- **Service Kit Content :**  
O-ring 9, Spring 2, Steel ball 1, Ball-bearing 2, Rotor blade 6, Gasket 1

SKU#	SQUARE DRIVE inch	STANDARD BOLT Size inch	FREE SPEED RPM	MAX. TORQUE Nm	OVERALL LENGTH mm	AIR INLET PT	AIR HOSE I.D	AVG. AIR CONSUMPTION cfm (l/min)	NOISE LEVEL dB	NET WEIGHT (kg)
STMT99300-8	1/2	3/4	8,000	610	193	1/4	3/8	4.4(125)	83.79	2.15



### 1/2" Impact Wrench 244Nm

- End cap slider-guide trigger - designed for easy operation
- Improved throttle valve seat - allows easier maintenance
- Composite grip - super lightweight, ergonomic design isolating from the coldness
- Improved air inlet - effectively reduces the damage and loss of thread
- Three-speed control for forward and one-speed full output for reverse direction
- Patented three-way air inlet function - increase 10% and more at horsepower delivery than same level tools
- **Service Kit Content :**  
O-ring 9, Spring 2, Steel ball 1, Ball-bearing 2, Rotor blade 6, Gasket 1

SKU#	SQUARE DRIVE inch	STANDARD BOLT Size inch	FREE SPEED RPM	MAX. TORQUE Nm	OVERALL LENGTH mm	AIR INLET PT	AIR HOSE I.D	AVG. AIR CONSUMPTION cfm (l/min)	NOISE LEVEL dB	NET WEIGHT (kg)
STMT70116-8	1/2	3/4	9,000	244	166	1/4	3/8	3.1 CFM	86	1.27



# TORQUE CONTROL

The torque wrench is an essential hand tool that is now fundamental in all garages and workshops. The Britool torque wrench range has been carefully designed to provide a range of solutions to meet the needs of the torque-tightening user.

## What is Torque ?

- Torque is a turning or twisting force, the result of a force applied at a given distance about a known centre
- It is recorded in units of force x distance  
i.e. Nm = Newtons (force) x metres (distance) or  
lbf/ft = lbf (force) x feet (distance) (1 Newton = 1kg m/s<sup>2</sup>)

## Classic Mechanical Torque Wrenches

The Britool Classic torque wrench has won a reputation for reliability and quality established over 50 years. The unique mechanism has distinct advantages which ensure it remains a firm favourite with users worldwide.

## Unique 3-phase Mechanism

A progressive torque build-up to the selected setting is easily detected by three clear signals:

- 1. SIGHT** see the mechanism progressively move towards the point of break as the load is applied
- 2. TOUCH** feel the point of torque
- 3. SOUND** unmistakable CLICK This makes it ideal for use in noisy environments

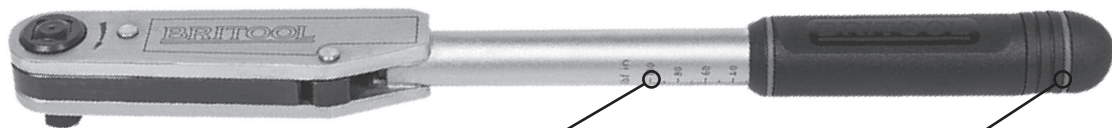

**ACCESSIBILITY**  
Compact design ideal for restricted access

**DURABILITY**  
Proven to be one of the most robust products in the market, the first choice for arduous conditions

**ACCURACY**  
Exceeds requirements of ISO 6789

**SCALE**  
Multiple scales – Nm, kg.m, lbf.in and lbf.ft are branded into steel tube, giving read ability for the life of the product

**FLEXIBILITY**  
Push-through square drive for left and right hand operation

**SETTING**  
Retractable adjuster knob cannot be altered by accident

**SERVICE**  
Fully repairable with dedicated service kits

## Classic Mechanical Torque Wrench – Non-Length Dependant

Unlike most other torque wrenches, the mechanism pivots around the square drive. This gives the major advantage in that the torque wrench is not length dependant. As a result there is no variation to the application of the preset torque value, no matter where the handle is grasped.

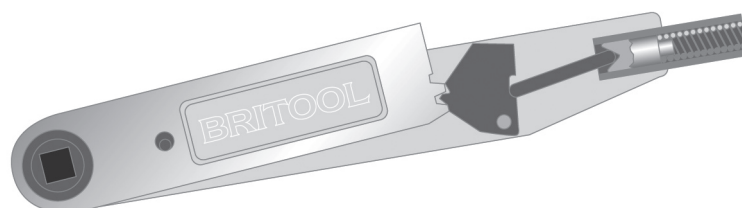

## 6 MECHANIC TOOLS



### AVT100A

Certified accuracy to  $\pm 4\%$

3/8" Classic					
Ref	Square drive	Torque range Nm	Length mm	N.m	lbf.ft
AVT100A	3/8"	2.5-11	318	0.5	1.0
AVT300A	3/8"	5-33	422	1.0	1.0
AVT600	3/8"	12-68	476	2.0	2.0



### EVT3000A

Exceeds The Requirements Of ISO 6789

1/2" Classic					
Ref	Square drive	Torque range Nm	Length mm	N.m	lbf.ft
EVT600A	1/2"	12-68	476	2.0	1.0
EVT1200A	1/2"	25-135	546	5.0	1.0
EVT2000A	1/2"	50-225	597	5.0	2.0
EVT3000A	1/2"	70-330	825	10.0	10.0



### GVT8400

3/4" & 1" Classic					
Ref	Square drive	Torque range Nm	Length mm	N.m	lbf.ft
HVT5000	3/4"	140-560	1130	10.0	10.0
HVT7200	3/4"	200-810	1181	10.0	10.0
GVT8400	1"	480-940	1397	10.0	10.0

## Lever Action Grease Gun



- Precision-fitted and hardened plunger prevents lubricant escape from cartridge
- Extra-long handle for increased leverage and easy operation
- Rugged cast pump head for strength and durability and tough impact resistant construction
- Uses standard grease cartridge or can be used for bulk fill
- Heavy-duty
- Easy to operate
- Non-slip grip handle
- 12000PSU pressure
- High volume operation

SKU#	DESCRIPTION	VOLUME		LENGTH		BOX / CTN
		oz	gr	Inch	mm	
95-385-2V	Lever Action Grease Gun	14	400	6	150	6/24

## General Purpose Tool Box

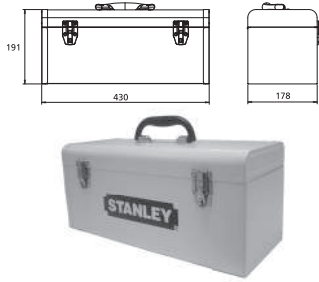

- Overall dimension 430 x 178 x 191mm (W x D x H)
- ElectroPowder Coating to resist scratch and solvent markings
- Heavy-duty metal for body construction and handle to provide ultimate durability
- Double latch for greater strength
- Removable steel tray

NEW SKU#	SKU#	DESCRIPTION	BOX/CTN
N/A	93-544	General Purpose Tool Box	1/1

## 3-Tray Cantilever Box

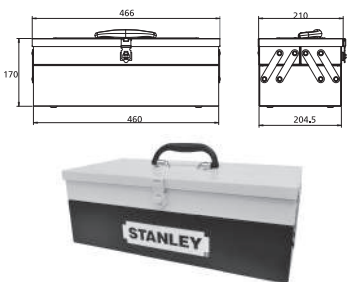

- Overall dimension 466 x 210 x 170mm (W x D x H)
- Electro-Powder Coating to resist scratch and solvent markings
- Heavy-duty metal for body construction and handle to provide Ultimate durability
- Single latch for greater strength
- Tray swing out for easy tool access

NEW SKU#	SKU#	DESCRIPTION	BOX/CTN
N/A	94-192-23	3 Tray Cantilever Box	1/1

## 4 Drawers Roller Cabinet

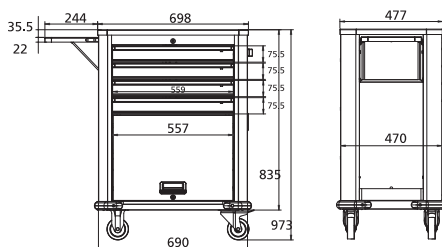

- Overall dimension 698 x 477 x 973mm (W x D x H)
- Drawer dimension 560 x 410 x 75.5mm (W x D x H)
- Load capacity of top tray is 30kg, every drawer is 25kg, and bottom is 35kg
- Plastic top tray to organize tools
- Comes with folding tray
- Lockable wheel with Rubber Castor
- Concave on both sides to hold more tools
- Bumper rubber on corners to prevent scratching

NEW SKU#	SKU#	DESCRIPTION	BOX/CTN
STMT99069-8	99-069	4 Drawers Roller Cabinet	1/1



## 7-Piece 1/2" Drive Hex Bit Socket Set



- Perfect use for temper-proof star fasteners in today's automotive vehicles and appliances
- Drop-forged, heat-treated chrome vanadium steel
- Corrosion-resistant finish
- Perfect use for temper-proof star fasteners in today's cars, trucks and appliances
- Precision-machined tip for exact fit

### METRIC

- **7 pcs 1/2" dr Hex bit socket set :**  
6, 8, 10, 12, 14, 17, 19mm
- 1 Blow-mold case

NEW SKU#	SKU#	DESCRIPTION	WEIGHT (g)	BOX/CTN
N/A	89-099-1	7 Piece 1/2" Drive Hex Bit Socket Set	1200	1/12

## 21-Piece 1/4" Drive Socket Set

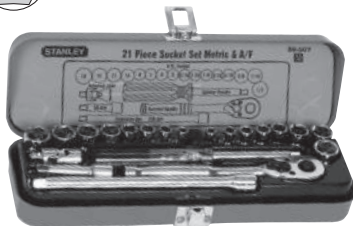

### METRIC

- **8 pcs 1/4" dr 6 pt sockets :**  
5, 6, 7, 8, 10, 11, 12, 13mm

### INCH

- **8 pcs 1/4" dr 6 pt sockets :**  
3/16, 7/32, 1/4, 9/32, 5/16, 3/8, 7/16, 1/2"
- **4 pcs 1/4" dr accessories :**  
2 Extension bar: 2" & 6", 1 Universal joint, 1 Spinner handle

NEW SKU#	SKU#	DESCRIPTION	WEIGHT (kg)	BOX/CTN
N/A	89-507	21-Piece 1/4" Drive Socket Set	4.58	4/4

## 35-Piece 1/4" Drive Socket Set



### METRIC

- **13 pcs 1/4" dr 6 pt sockets :**  
4, 4.5, 5, 5.5, 6, 7, 8, 9, 10, 11, 12, 13, 14mm
- **5 pcs 1/4" dr accessories :**  
1 Spinner handle, 2 Extensions: 75, 150mm, 1 Universal joint, 1 Hex bit holder
- **4 Hex bits : 3, 4, 5, 6mm, 6 Torx® bits :**  
T10, 15, 20, 25, 30, 40
- **3 Posidriv bits :** 1, 2, 3, and 3 Slotted bits: 4, 5.5, 6.5mm
- 1 pc Quick release ratchet pear head
- 1 Blow-mould case

NEW SKU#	SKU#	DESCRIPTION	WEIGHT (kg)	BOX/CTN
N/A	89-033-1	35-Piece 1/4" Drive Socket Set	1.2	1/16

## 37-Piece 1/4" & 3/8" Drive Socket Set

METRIC

- 9 pcs 1/4" dr 6 pt sockets :  
4, 5, 6, 7, 8, 9, 10, 11, 12mm
- 9 pcs 3/8" dr 12 pt sockets :  
8, 10, 11, 12, 13, 14, 16, 17, 19mm

INCH

- 9 pcs 1/4" dr 6 pt sockets :  
3/16, 7/32, 1/4, 9/32, 5/16, 11/32, 3/8, 7/16, 1/2"
- 7 pcs 3/8" dr 12 pt sockets :  
3/8, 7/16, 1/2, 9/16, 5/8, 11/16, 3/4"
- 2 pcs 3/8" dr accessories :  
1 Adapter, 1 1/4" dr spinner handle
- 1 "Full Polish" Quick release ratchet
- 1 Metal box



NEW SKU#	SKU#	DESCRIPTION	WEIGHT (kg)	BOX/CTN
N/A	89-518-1	37-Piece 1/4" & 3/8" Drive Socket Set	5.14	2/2

## 24-Piece 3/8" Drive Socket Set

METRIC

- 19 pcs 3/8" dr 6 pt sockets :  
6, 7, 8, 9, 10, 11, 12, 13, 14, 15, 16, 17, 18, 19, 20, 21, 22, 23, 24mm
- 4 pcs 3/8" dr accessories :  
2 Extensions: 75, 150mm, 1 Universal joint, 1 Sliding T-bar
- 1 pc 3/8" Quick release ratchet pear head
- 1 Blow-mold case



NEW SKU#	SKU#	DESCRIPTION	WEIGHT (kg)	BOX/CTN
N/A	89-035-1	24-Piece 3/8" Drive Socket Set	3	1/8



## 48-Piece 3/8" Drive Socket Set

METRIC

- **12 pcs 3/8" dr 12 pt sockets :**  
8, 9, 10, 11, 12, 13, 14, 15, 16, 17, 18, 19mm

INCH

- **7 pcs 3/8" dr 12 pt sockets :**  
3/8, 7/16, 1/2, 9/16, 5/8, 11/16, 3/4"
- **18 pcs 1/4" dr Bit set :**  
6 Hex bits: 3, 4, 5, 6, 7, 8mm, 6 Torx® bits: T10, 15, 20, 25, 30, 40,  
3 Posidriv bits: 1, 2, 3, and 3 Slotted bits: 4, 5, 6.5mm
- **8 pcs 3/8" dr accessories:**  
2 Spark plug 6pt socket: 5/8" & 13/16", 2 Extension bar: 3" & 6",  
1 Universal joint, 1 Adapter, 1 1/4" dr spinner handle,  
1 1/4" dr bit adapter
- 1 pc "Full Polish" Quick release ratchet
- 1 Metal box



NEW SKU#	SKU#	DESCRIPTION	WEIGHT (kg)	BOX/CTN
N/A	89-516-1	48-Piece 3/8" Drive Socket Set	6.12	2/2

## 13-Piece 1/2" Drive Socket Set

METRIC

- **10 pcs 1/2" dr 12 pt sockets:**  
10, 11, 12, 13, 14, 16, 17, 19, 21, 22mm
- **2 pcs 1/2" dr accessories:**  
1 Extension bar: 5", 1 Sliding T bar
- 1 pc 1/2" Flip drive ratchet



NEW SKU#	SKU#	DESCRIPTION	BOX/CTN
N/A	86-501	13-Piece 1/2" Drive Socket Set	1/6

## 16-Piece 1/2" Drive Socket Set

METRIC

- **13 pcs 1/2" dr 12 pt sockets :**  
8, 10, 11, 12, 13, 14, 16, 17, 18, 19, 21, 22, 24mm
- **2 pcs 1/2" dr accessories :**  
125mm Extension bar, Universal joint
- 1 pc 1/2" Quick release ratchet pear head
- 1 Blow-mould case



NEW SKU#	SKU#	DESCRIPTION	WEIGHT (kg)	BOX/CTN
N/A	89-092-1	16-Piece 1/2" Drive Socket Set	3	1/6

## 25-Piece 1/2" Drive Socket Set



METRIC

- **17 pcs 1/2" dr 6 pt sockets :**  
10, 11, 12, 13, 14, 15, 17, 18, 19, 20, 21, 22, 23, 24, 27, 30, 32mm
- **6 pcs 1/2" dr accessories:**  
1 Spark plug socket, 1 Sliding T-Bar: 10",  
1 Universal joint, 1 Flex handle: 17", 2 Extension bar: 5" & 10"
- 1 pc "Fully Polished" Quick release ratchet
- 1 Blow-mold case

NEW SKU#	SKU#	DESCRIPTION	WEIGHT (kg)	BOX/CTN
N/A	86-589-1	25-Piece 1/2" Drive Socket Set	5,8	1/4

## 26-Piece 1/2" Drive Socket Set



INCH

- **20 pcs 1/2" dr 12 pt sockets :**  
1/4, 5/16, 3/8, 7/16, 1/2, 9/16, 19/32, 5/8, 11/16, 3/4,  
25/32, 13/16, 7/8, 15/16, 31/32, 1, 1-1/16, 1-1/8, 1-3/16, 1-1/4"
- **5 pcs 1/2" dr accessories :**  
2 Extension bar: 5" & 10", 1 Universal joint,  
1 Spark plug socket 6 pt 13/16", 1 Sliding T-Bar: 9.5"
- 1 pc Flip-drive ratchet
- 1 Blow-mold case

NEW SKU	SKU#	DESCRIPTION	WEIGHT (kg)	BOX/CTN
86-478	86-478-23	26-Piece 1/2" Drive Socket Set	4,59	4/4

## 26-Piece 1/2" Drive Socket Set



METRIC

- **20 pcs 1/2" dr 12 pt sockets :**  
10, 11, 12, 13, 14, 15, 16, 17, 18, 19, 20, 21, 22, 23, 24, 25, 26, 27, 30,  
32mm
- **5 pcs 1/2" dr accessories :**  
2 Extension bar: 5" & 10", 1 Universal joint,  
1 Spark plug socket 6pt 13/16", 1 sliding T-Bar: 9.5"
- 1 pc Flip-drive ratchet
- 1 Blow-mold case

NEW SKU#	SKU#	DESCRIPTION	WEIGHT (kg)	BOX/CTN
N/A	86-477	26-Piece 1/2" Drive Socket Set	4,55	1/4



## 43-Piece 1/2" Drive Socket Set

### METRIC

- **20 pcs 1/2" dr 12 pt sockets :**  
10, 11, 12, 13, 14, 15, 16, 17, 18, 19, 20, 21, 22, 23, 24, 26, 27, 28, 30, 32mm

### INCH

- **15 pcs 1/2" dr 12 pt sockets :**  
3/16, 7/16, 1/2, 9/16, 5/8, 11/16, 3/4, 13/16, 7/8, 15/16, 1, 1-1/16, 1-1/8, 1-3/16, 1 1/4"
- **7 pcs 1/2" dr accessories :**  
2 Spark plug 6pt socket: 5/8" & 13/16",  
3 Extension bar: 3", 5" & 10", 1 Universal joint,  
1 Flex handle: 375mm
- 1 pc "Full Polish" Quick release ratchet
- 1 Metal box



NEW SKU#	SKU#	DESCRIPTION	WEIGHT (kg)	BOX/CTN
N/A	89-509	43-Piece 1/2" Drive Socket Set	7.86	2/2

## 19-Piece 3/4" Drive Socket Set

### METRIC

- **15 pcs 3/4" dr 12 pt sockets :**  
22, 24, 27, 28, 29, 30, 32, 33, 34, 36, 38, 41, 42, 46, 50mm
- **3 pcs 3/4" dr accessories :**  
2 Extension 100 & 200mm, 1 Sliding T-bar 250mm
- 1 pc Standard ratchet
- 1 Blow-mold case



NEW SKU#	SKU#	DESCRIPTION	WEIGHT (kg)	BOX/CTN
N/A	89-101-1	19-Piece 3/4" Drive Socket Set	13	1/1

## 19-Piece 3/4" Drive Socket Set

### INCH

- **15 pcs 3/4" dr 12 pt sockets :**  
7/8, 15/16, 1, 1 1/6, 1 1/8, 1 3/16, 1 1/4, 1 5/16, 1 3/8, 1 13/16, 1 11/16, 1 5/8, 1 1/2, 1 7/8, 2"
- **3 pcs 3/4" dr accessories :**  
2 Extensions: 100 & 200mm, 1 Sliding T-Bar: 250mm
- 1 pc standard ratchet
- 1 Blow-mold case



NEW SKU#	SKU#	DESCRIPTION	WEIGHT (kg)	BOX/CTN
N/A	89-133-1	19-Piece 3/4" Drive Socket Set	13.4	1/2



## Stanley Classic Metal Case 24pcs 1/2" 12pts Socket Set

METRIC



- 18 pcs 1/2" dr 12pt socket :-  
8, 9, 10, 11, 12, 13, 14, 15, 16, 17, 18, 19, 21, 22, 24, 27, 30, 32
- 5 pcs 1/2" dr accessories :  
2 Extensions: 125mm, 250mm  
1 Pear Head Ratchet  
1 L-Handle 200mm  
1 Universal Joint
- 1 plastic module

SKU#	DESCRIPTION	Weight (g)	BOX/CTN
STMT74184-8	24 PCS 1/2 12PTS Socket Set (without clear case)	-	-

## 36-Piece 3/8" Metric Socket Module



COMPATIBLE with  
**TRANS  
MODULE**  
system

- 3/8" 12PT Standard socket 8, 9, 10, 11, 12, 13, 14, 15, 16, 17, 18, 19, 21, 22mm
- 3/8" 6PT Deep socket 8, 10, 11, 12, 13, 14, 15, 16, 17, 18, 19, 21, 22mm
- 3/8" Hexagon bit socket 4, 5, 6mm
- 3/8" Torx bit socket T25, T30, T40
- 3/8" Extension 125mm
- 3/8" Universal joint
- 3/8" Pear head ratchet NP9



SKU#	DESCRIPTION	Length mm	Width mm	Height mm	Cartoon Qty
STMT74174-8	36 PCS 3/8" Metric Socket Module	384	184	45	4

## 24-Piece 1/2" Metric Bit Socket Module



COMPATIBLE with  
**TRANS  
MODULE**  
system

- 1/2" Torx bit socket T20, T25, T27, T30, T40, T45, T50, T55, T60
- 1/2" Long torx bit socket T30, T40, T45, T50, T55, T60
- 1/2" Torx socket E10, E11, E12, E14, E16, E18, E20, E22, E24



SKU#	DESCRIPTION	Length mm	Width mm	Height mm	Cartoon Qty
STMT74176-8	24 PCS 1/2" Metric Bit Socket Module	384	184	45	4

## 6 MECHANIC TOOLS

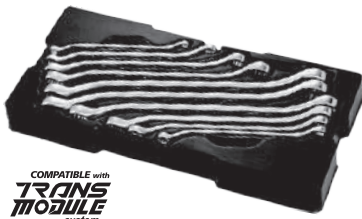

COMPATIBLE with  
**TRANS  
MODULE**  
system



### 10-Piece Offset Double Ring Module

- Offset double ring wrench 6x7mm
- Offset double ring wrench 8x9mm
- Offset double ring wrench 10x12mm
- Offset double ring wrench 11x13mm
- Offset double ring wrench 12x14mm
- Offset double ring wrench 14x15mm
- Offset double ring wrench 16x17mm
- Offset double ring wrench 18x19mm
- Offset double ring wrench 21x23mm
- Offset double ring wrench 22x24mm

SKU#	DESCRIPTION	Length mm	Width mm	Height mm	Cartoon Qty
STMT74177-8	10 PCS Offset Double Ring Module	384	184	45	4

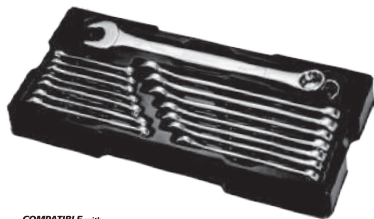

COMPATIBLE with  
**TRANS  
MODULE**  
system



### 16-Piece Combination Wrench Module (CWF)

- Combination wrench 6mm
- Combination wrench 7mm
- Combination wrench 8mm
- Combination wrench 9mm
- Combination wrench 10mm
- Combination wrench 11mm
- Combination wrench 12mm
- Combination wrench 13mm
- Combination wrench 14mm
- Combination wrench 15mm
- Combination wrench 16mm
- Combination wrench 17mm
- Combination wrench 18mm
- Combination wrench 19mm
- Combination wrench 22mm
- Combination wrench 24mm

SKU#	DESCRIPTION	Length mm	Width mm	Height mm	Cartoon Qty
STMT74178-8	16 PCS Combination Wrench Module (CWF)	384	184	45	4

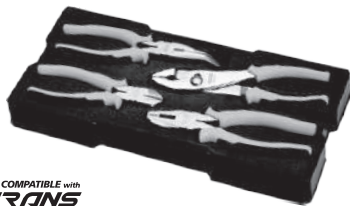

COMPATIBLE with  
**TRANS  
MODULE**  
system



### 4-Piece Pliers Module

- 8" Bent nose pliers
- 6" Diagonal cutting pliers
- 7" Linesman pliers
- 8" Slip joint pliers

SKU#	DESCRIPTION	Length mm	Width mm	Height mm	Cartoon Qty
STMT74179-8	4 PCS Pliers Module	384	184	45	4

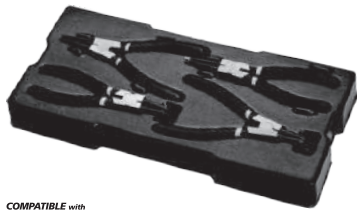

COMPATIBLE with  
**TRANS  
MODULE**  
system



## 4-Piece Circlips Pliers Module

- 7" Basic circlip plier straight exterior type
- 7" Basic circlip plier bent exterior type
- 7" Basic circlip plier straight interior type
- 7" Basic circlip plier bent interior type

SKU#	DESCRIPTION	Length mm	Width mm	Height mm	Cartoon Qty
STMT74180-8	4 PCS Circlips Pliers Module	384	184	45	4



COMPATIBLE with  
**TRANS  
MODULE**  
system

## 8-Piece Screwdrivers Module

- Cushion grip standard 3mm x 100mm
- Cushion grip standard parallel 5mm x 150mm
- Cushion grip standard 6.5mm x 150mm
- Cushion grip standard 8mm x 200mm
- Cushion grip phillips PH0 x 60mm
- Cushion grip phillips PH1 x 100mm
- Cushion grip phillips PH2 x 125mm
- Cushion grip phillips PH3 x 150mm

SKU#	DESCRIPTION	Length mm	Width mm	Height mm	Cartoon Qty
STMT74181-8	8 PCS Screwdrivers Module	384	184	45	4

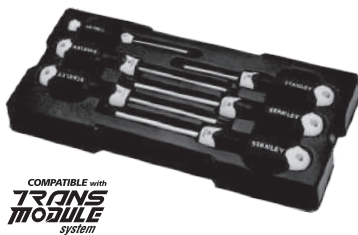

COMPATIBLE with  
**TRANS  
MODULE**  
system

## 6-Piece Torx Screwdrivers Module

- Cushion grip torx T10 x 80mm
- Cushion grip torx T15 x 80mm
- Cushion grip torx T20 x 120mm
- Cushion grip torx T25 x 120mm
- Cushion grip torx T30 x 120mm
- Cushion grip torx T40 x 120mm

SKU#	DESCRIPTION	Length mm	Width mm	Height mm	Cartoon Qty
STMT74182-8	6 PCS Torx Screwdrivers Module	384	184	45	4

## 6 MECHANIC TOOLS

### 16" Tool Set Case



#### ONE HAND OPERATION

Single sliding latch drives efficient work flow

COMPATIBLE with  
**TRANS  
MODULE**  
system

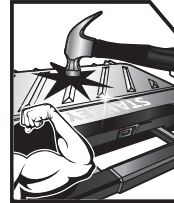

#### TOUGH LID

Extra tough transparent cover design provides clear visibility & protection

#### REMOVABLE DIVIDER

For additional arrangement



#### BIG HANDLE

Easy-to-carry handle

Label slot for unit identification

SKU#	DESCRIPTION	Length mm	Width mm	Height mm	Weight (kg)	Latch
STST74301-8	16" Tool Set Case	405	290	60	0.7	Plastic

### 23-Piece 1/2" 12pts Flex Wrench Metric Socket Module Set



#### 16" TOOL SET CASE + MODULE :

- 1/2" 12 PTS Standard socket 8, 9, 10, 11, 12, 13, 14, 15, 16, 17, 18, 19, 21, 22, 24, 27, 30, 32mm
- 1/2" SD pear head ratchet NP9
- Flexible socket wrench 10 x11mm
- 1/2" Extension 125, 250mm
- 1/2" Universal joint



SKU#	DESCRIPTION	Length mm	Width mm	Height mm	Weight (kg)	Box Qty
STMT75095-8C	23PCS 1/2" 12PTS Flex Wrench Metric Socket Module Set	405	290	60	4	1

## 16-Piece Slimline Combination Wrench Module Set



### 16" TOOL SET CASE + MODULE :

- Slim line combination wrench  
6, 7, 8, 9, 10, 11, 12, 13, 14, 15,  
16, 17, 19, 21, 22, 24mm

SKU#	DESCRIPTION	Length mm	Width mm	Height mm	Weight (kg)	Box Qty
STMT74897-8C	16PCS Slimline Combination Wrench Module Set	405	290	60	2.6	1

## 23-Piece 1/2" 6PTS Metric Socket Set



### 16" TOOL SET CASE + MODULE :

- 1/2" Pear head ratchet NP9
- 1/2" L-handle 90 degree
- 1/2" Extension 125, 250mm
- 1/2" Universal joint
- 1/2" 6PTS Standard socket 8, 9, 10,  
11, 12, 13, 14, 15, 16, 17, 18, 19, 21,  
22, 24, 27, 30, 32mm

SKU#	DESCRIPTION	Length mm	Width mm	Height mm	Weight (kg)	Box Qty
STMT74173-8C	23 PCS 1/2" 6 PTS Metric Socket Set	405	290	60	3.95	1

## 23-Piece 1/2" 6pts Metric Socket Module



- 1/2" 6 PTS Standard socket 8, 9, 10,  
11, 12, 13, 14, 15, 16, 17, 18, 19, 21,  
22, 24, 27, 30, 32mm
- 1/2" Pear head ratchet NP9
- 1/2" L-handle 90 degree
- 1/2" Extension 125, 250mm
- 1/2" Universal joint



SKU#	DESCRIPTION	Length mm	Width mm	Height mm	Cartoon Qty
STMT74173-8	23 PCS 1/2" 6PTS Metric Socket Module	384	184	45	4

## 6 MECHANIC TOOLS



### 23-Piece 1/2" 12pts Metric Socket Module

- 1/2" 12 PTS Standard socket 8, 9, 10, 11, 12, 13, 14, 15, 16, 17, 18, 19, 21, 22, 24, 27, 30, 32mm
- 1/2" Pear head ratchet NP9
- 1/2" L-handle 90 degree
- 1/2" Extension 125, 250mm
- 1/2" Universal joint

SKU#	DESCRIPTION	Length mm	Width mm	Height mm	Cartoon Qty
STMT74726-8	23 PCS 1/2" 12PTS Metric Socket Module	384	184	45	4



### 23-Piece 1/2" 12pts Metric Socket Set

#### 16" TOOL SET CASE + MODULE :

- 1/2" 12 PTS Standard socket 8, 9, 10, 11, 12, 13, 14, 15, 16, 17, 18, 19, 21, 22, 24, 27, 30, 32mm
- 1/2" Pear head ratchet NP9
- 1/2" L-handle 90 degree
- 1/2" Extension 125, 250mm
- 1/2" Universal joint

SKU#	DESCRIPTION	Length mm	Width mm	Height mm	Weight (kg)	Box Qty
STMT74726-8C	23 PCS 1/2" 12 PTS Metric Socket Set	405	290	60	3.95	1

### 125-Piece 1/4" & 3/8" & 1/2" Multi Tool Set

- Slim Line Combination Wrench (CWE)
- Test pencil
- 2-Way Oil-filter wrench 63-102mm
- 1/4" 6PTS Standard socket 3.5, 4, 4.5, 5, 5.5, 6, 7, 8mm
- 1/4" 6PTS Deep socket 5, 6, 7, 8mm
- 1/4" Extension 2"
- 1/4" Bits driver
- 1/4" Universal joint
- 1/4" Bits holder
- 1/4" Pear head ratchet NP9
- 1/4" Resistorx bit TT10, TT15, TT20, TT25, TT27, TT30, TT40
- 1/4" Hexagon bit 3, 4, 5, 6mm
- 1/4" Slotted bit 4, 5, 6.5mm
- 1/4" Phillips bit PH1, PH2, PH3
- 1/4" Pozidriv bit PZ1, PZ2, PZ3
- 3/8" 6PTS Standard socket 9, 10, 11, 12, 13, 14, 15, 16, 17mm
- 3/8" 6PTS Deep socket 10, 12, 13, 14, 15, 17mm
- 3/8" Pear head ratchet NP9
- 3/8" Torx socket E6, E8, E10, E11, E12, E14, E16, E18
- 3/8" Spark Plug 14, 16, 21mm
- 3/8" Extension 3", 10"
- 3/8" Universal joint
- 3/8" 3-way coupler 3/8" F x 1/4" M, 3/8" F x 1/2" M
- 3/8" Torx bit socket T-20, T-30, T-40, T-45, T-50, T-55
- 3/8" Hexagon bit socket 3, 4, 5, 6mm
- 3/8" Phillips bit socket PH1, PH2
- 3/8" Pozidriv bit socket PZ1, PZ2
- 3/8" Slotted bit socket 5.5, 6.5mm
- 1/2" 6PTS Standard socket 18, 19, 20, 21, 22, 23, 24, 27, 30, 32mm
- 1/2" Pear head ratchet NP9
- 1/2" Universal joint
- 1/2" Extension 5", 10"
- 9PCS Long hex key
- Phillips screwdriver PH2 x 100mm
- Slotted screwdriver 6 x 100mm
- Long nose pliers 6"
- Combination pliers 8"
- Slip joint pliers 8"



6-24V test pencil



Adjustable oil filter wrench

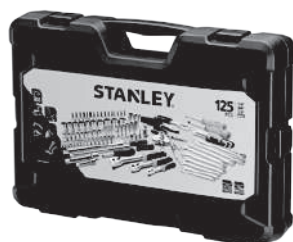

SKU#	DESCRIPTION	Length mm	Width mm	Height mm	Weight kg
STMT74393-8-23	125PCS Multi-Tool Set	526	355	96	10.1

## 4 Drawers Roller Cabinet



- Multiple drawer sizes for flexible storage options
- Perforated side panels for more storage options
- Ball bearing slides for smooth and heavy loading drawer operation
- Lockable castors
- PVC bumpers on corners
- Lockable drawers

COMPATIBLE with  
**TRANS  
MODULE**  
system

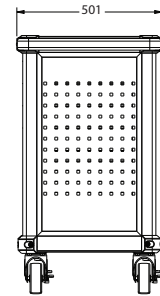
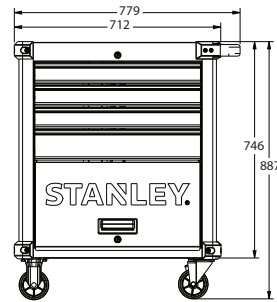

SKU#	DESCRIPTION	Overall Dimension (Length x Width x Height mm)	Effective Drawer Dimension mm	Total Load Capacity kg	Drawer Load Capacity kg	Compartment Load Capacity kg	Drawer Qty
STST74305-8	4 Drawers Roller Cabinet	690 x 426 x 889	Top 3: 540 x 408 x 72 Bottom 1: 540 x 408 x 105	300	20	35	4



## 4 Drawers Roller Cabinet With ABS Top Tray

- Ball bearing slides for smooth and heavy loading drawer operation
- ABS top tray
- Side folding shelf
- Lockable wheel with rubber castors
- Side can and screwdriver holders
- Rubber bumpers on corners
- Lockable drawers

COMPATIBLE with  
**TRANS  
MODULE**  
system

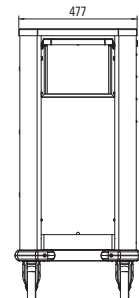
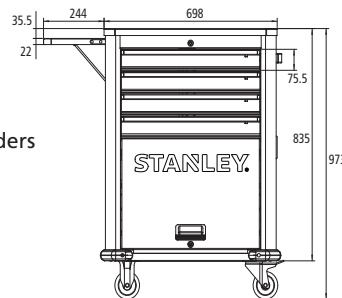

SKU#	DESCRIPTION	Overall Dimension (Length x Width x Height mm)	Effective Drawer Dimension mm	Total Load Capacity kg	Drawer Load Capacity kg	Compartment Load Capacity kg	Drawer Qty
STMT99069-8	4 Drawers Roller Cabinet	698 x 477x 973	536 x 410 x 75.5	300	25	35	4

1 MEASURING & LAYOUT TOOLS

2 CUTTING & HOLDING TOOLS

3 FASTENING TOOLS

4 STRIKING & STRUCK TOOLS

5 PAINTING & FINISHING TOOLS

6 MECHANIC TOOLS

7 TOOLS STORAGE

## 6 MECHANIC TOOLS

### 125-Piece STANLEY® Classic 1/2" Socket Set

**PRECISION  
TORQUE  
DURABILITY**

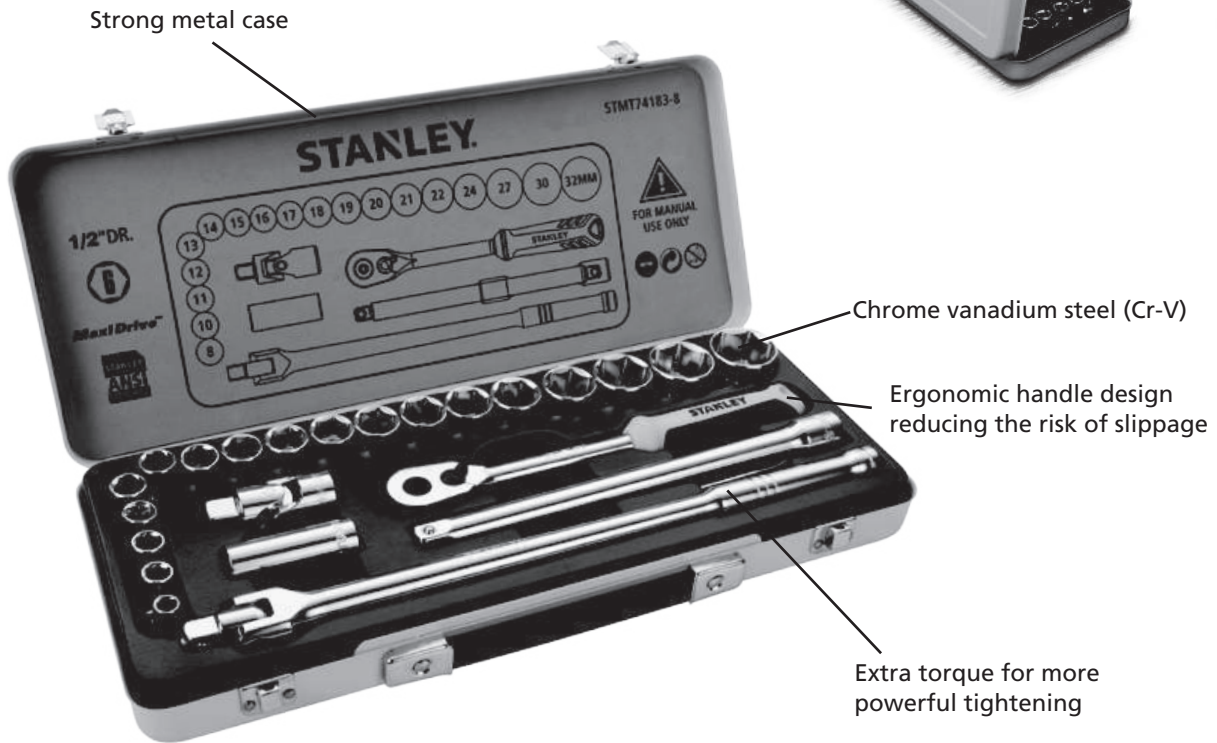
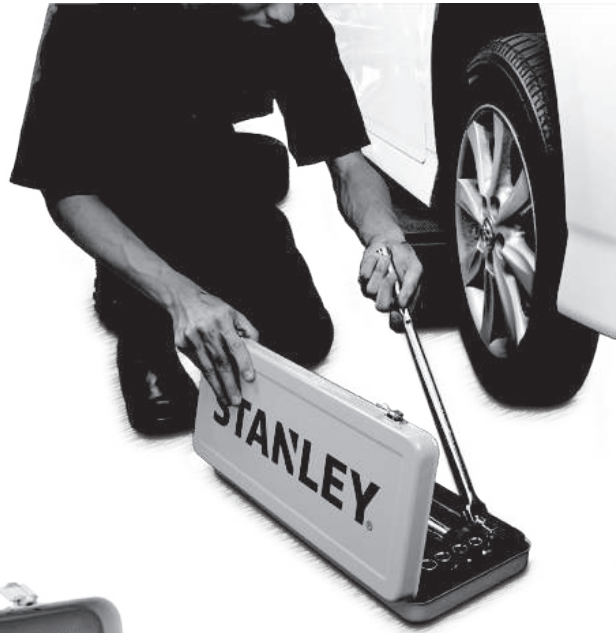

Strong metal case

Chrome vanadium steel (Cr-V)

Ergonomic handle design  
reducing the risk of slippage

Extra torque for more  
powerful tightening

#### 24PCS 1/2" 6PTS CONTENTS:

- 1/2" Pear head ratchet NP9
- 1/2" Extension 125, 250mm
- 1/2" Universal joint
- 1/2" 6PTS Spark plug socket 16mm
- 1/2" 15" Swivel handle
- 1/2" 6PTS Standard socket 8, 10, 11, 12, 13, 14, 15, 16, 17, 18, 19, 20, 21, 22, 24, 27, 30, 32 mm

#### 24PCS 1/2" 12PTS CONTENTS:

- 1/2" Pear head ratchet NP9
- 1/2" Extension 125, 250mm
- 1/2" Universal joint
- 1/2" 12PTS Spark plug socket 16mm
- 1/2" 15" Swivel handle
- 1/2" 12PTS Standard socket 8, 10, 11, 12, 13, 14, 15, 16, 17, 18, 19, 20, 21, 22, 24, 27, 30, 32 mm



SKU#	DESCRIPTION	Length mm	Width mm	Height mm	Weight (kg)	Carton Qty
STMT74183-8	24PCS 1/2" 6PTS Socket Set In Metal Tin	428	175	52	4.89	2
STMT74184-8	24PCS 1/2" 12PTS Socket Set In Metal Tin	428	175	52	4.89	2



## 71-Piece 1/4" & 3/8" Multi Tool Set

- Slim line combination wrench (CWE) 8, 10, 12, 13, 14, 16, 17, 18, 19mm
- 1/4" 6PTS Standard socket 4, 4.5, 5, 5.5, 6, 7, 8mm
- 1/4" 6PTS Deep socket 5, 6, 7, 8mm
- 1/4" Extension 2"
- 1/4" Torx bits T10, T15, T20, T30, T40
- 1/4" Phillips bit PH1,PH2,PH3
- 1/4" Slotted bit 4,5,5,6,5mm
- 1/4" Bits driver
- 1/4" Bit holder
- 1/4" Universal joint
- 1/4" Pear head ratchet NP9
- 3/8" 6PTS Standard socket 9, 10, 11, 12, 13, 14, 15, 16, 17, 18, 19, 20, 21, 22, 24mm
- 3/8" 6PTS Deep socket 10,12, 13, 14, 15, 17, 19, 21mm
- 3/8" Spark plug 16, 21mm
- 3/8" Extension 3" & 10"
- 3/8" Universal joint
- 3/8" 3-Way Coupler 3/8"F x 1/4"M
- 3/8" SD Pear head ratchet NP9
- Phillips screwdriver PH2 x 100mm
- Slotted screwdriver 6 x 100mm
- Long nose plier 6"
- Combination plier 8"
- Slip-joint plier 8"



SKU#	DESCRIPTION	Length mm	Width mm	Height mm	Weight kg	MOQ
STMT74394-8	71PCS Multi-Tool Set	144	50	96	6.2	300

## 110PC Multi Tool Set

- Diagonal cutting pliers 6"
- Long Nose Pliers 8"
- Groove Joint Pliers 10"
- 1/4" Bit adapter ratcheting screwdriver 1/4"
- 40 Bits -
- Slotted bits: 3.5(2 parts), 4(2 parts), 5.5, 6.5 and 8 mm
- Square bits: S1, S2 and S3
- Phillips bits: # 0(2 parts), #1(2 parts), #2(2 parts), #3(2 parts)
- Adaptors(2 parts)
- Torx bits: T10, T15, T20, T25, T27, T30, T40
- Pozidriv bits: PZ1, PZ2, PZ3
- Tri-wing bits: 1, 2, 3, 4
- Hexagonal bits: 2, 3, 4, 5, 6, 7 mm
- 1/4" flexible extension 100mm - " 1/4" (M) x 1/4" (F)
- 1/4" Extension 50mm
- 1/4" Extension 100mm
- 1/2" Extension 125mm
- 1/2" Extension 250mm
- 1/2" 3 Way adaptor
- 1/4" Universal joint
- 1/2" Universal joint
- 1/2" Spark plug sockets 16mm
- 1/2" Spark plug 21mm
- 1/4" Ratchet with quick release button 72T
- 1/2" Ratchet with quick release button 72T
- Slotted screwdrivers: 5.5 x 75 mm, 6.5 x 100mm
- Phillips screwdriver: # 1 x 75mm, # 2 x 100 mm
- Combination wrenches: 8, 9, 10, 11, 12, 13, 14, 15, 17, 18, 19mm
- 8pc hexagonal key set: 1.5, 2, 2.5, 3, 4, 5, 5.5, 6mm
- 1/2" 6PT socket: 10, 11, 12, 13, 14, 15, 17, 18, 19, 20, 21, 22, 23, 24, 27mm
- 1/4" 6PT socket: 4, 5, 6, 7, 8, 9, 10, 11, 12, 13,14mm
- 1 Hex key rack
- 4 Bit racks



SKU#	DESCRIPTION
STMT81243-840	110PC Multi Tool Set

# GETTING THE BEST OUT OF A TORQUE WRENCH

## Information & Advice

As a precision instrument, the **STANLEY®** Torque wrench range is designed along best practice principles. To preserve the set calibration, the tool should be reset to 10% of the maximum capable load after each use. In order to provide a secure fastening without the risk of distortion, it is important to follow correct tightening sequences.

**IMPORTANT:** Torque specifications vary widely, always refer to the manufacturer's recommendation. The star pattern sequence should be used until all of the fasteners are tightened to the specified torque.

### RADIAL APPLICATIONS

For wheels and other radial applications, it is important to tighten the fasteners following the traditional star pattern sequence shown in the diagram on the right.

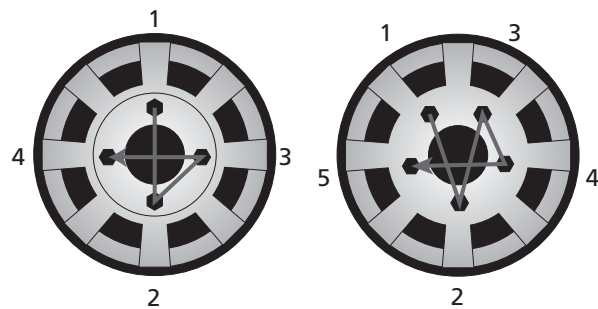

### CYLINDER HEAD APPLICATIONS

Always start in the middle of the engine, between cylinders 2 and 3 for a 4 cylinder engine. Move outwards in a spiral or crosswise outward direction along both sides. Tighten gradually, increasing the torque in stages on each fastener to ensure an even clamping force, until the outer bolts on Cylinders 1 and 4 have been tightened

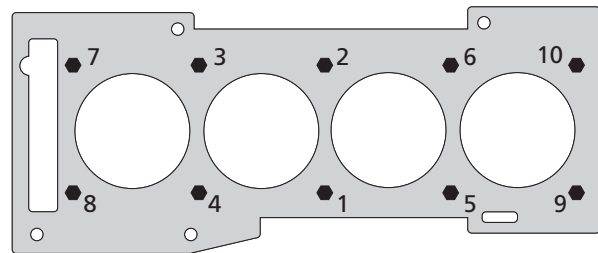

### FORMULA FOR CALCULATING THE EFFECT OF TORQUE WRENCH EXTENSIONS

In cases whereby special attachments change the calibration of the torque wrench or when it is impractical to use regular sockets (such as whilst tightening threaded connectors), it is necessary to calculate the accurate settings using the formulas shown in the diagram opposite:

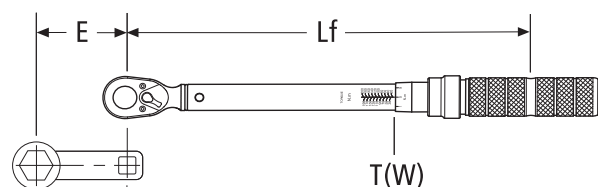

- E — Effective length of extension
- Lf — Lever length of the wrench: middle of handle to center of square drive
- T(W) — Torque setting on the wrench
- T(A) — Torque applied by the extension to the fastener
- T(A) —  $T(W) \times \frac{L_f + E}{L_f}$

# CONSISTENT PERFORMANCE, +/- 4% ACCURACY EVEN AFTER 20,000 CYCLES

Robust build quality and precision manufacturing ensures STANLEY® Torque wrenches meet and beat current standards, delivering reliability, day after day - year after year.

## Reliability Of Mechanism

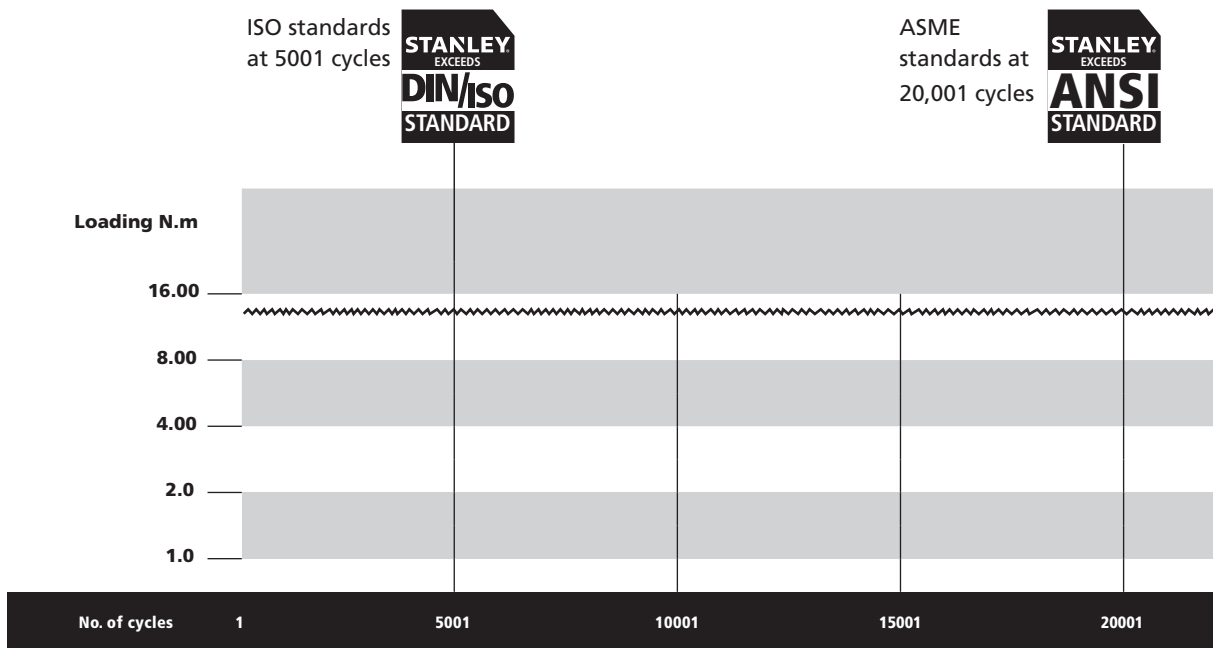

Test carried out using 1/4" drive, 5 - 25N.m 50% loading

## Torque Wrench Comparator

SKU #	Description	Drive Size	Torque Range	Increments N-m	Width mm	Length mm	Weight kg
STMT73587-8	1/4" TORQUE WRENCH 5-25 Nm	1/4"	5 - 25N-m 39.8-225.7 in-lb	0.1 N-m	22.5	246	0.365
STMT73588-8	3/8" TORQUE WRENCH 10-50Nm	3/8"	10 - 50N-m 9.2-38.7 ft-lb	0.5 N-m	31	409	1.182
STMT73589-8	1/2" TORQUE WRENCH 20-100Nm	1/2"	20 - 100N-m 16.6-75.6 ft-lb	0.5 N-m	31	409	1.19
STMT73590-8	1/2" TORQUE WRENCH 40-200Nm	1/2"	40 - 200N-m 33.2-151.2 ft-lb	1 N-m	41	519	1.6
STMT73591-8	1/2" TORQUE WRENCH 60-340Nm	1/2"	60 - 340N-m 51.6-258.1 ft-lb	2 N-m	41	610	1.785
STMT73592-8	3/4" TORQUE WRENCH 150-750Nm	3/4"	150 - 750N-m 110-550 ft-lb	2.5 N-m	58	1112	5.87

Dual Way Torque Wrench

# 48 GEAR TEETH FOR SMALL INCREMENT SETTING

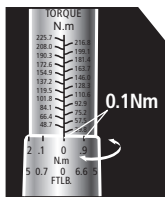
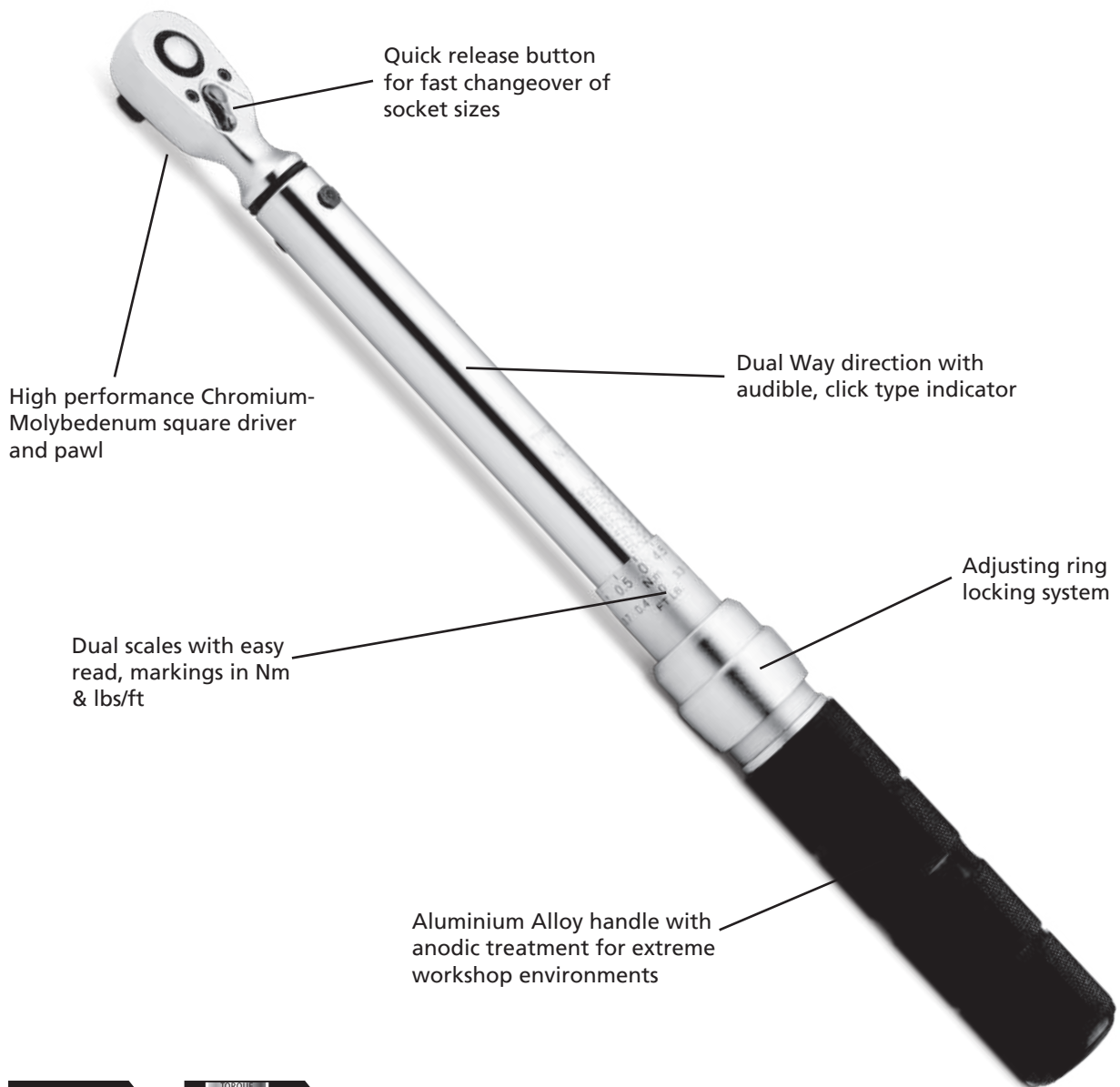

“ THIS TOOL HAS A SMOOTH ACTION AND FINE RATCHET, PLUS THE ABILITY TO TIGHTEN ACCURATELY IN BOTH DIRECTIONS. ”

## 1/4" Torque Wrench 5-25N-m



- ISO 6789, ASME B107.14
- Accuracy: +/- 4%
- Visual and audible indication
- Dual Way direction(C.W./C.C.W.) click Type
- Dual scales (N-m & in-lb.)
- Quick release button
- Adjusting ring locking system
- Aluminum Alloy handle with anodic treatment
- Si-Cr-Mo spring
- Cr-Mo pawl
- Cr-Mo square driver
- 48 Gear teeth

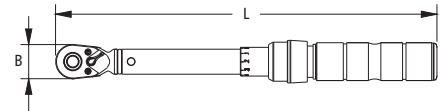

SKU#	DESCRIPTION	Drive Size	Torque Range	Torque Range	Increment	B (mm)	L (mm)	Weight (kg)
STMT73587-8	1/4" Torque Wrench 5-25N-m	1/4"	5-25N-m	48.7-225.7 in-lb.	0.1 N-m	22.5	246	0.365

## 3/8" Torque Wrench 10-50N-m



- ISO 6789, ASME B107.14
- Accuracy: +/- 4%
- Visual and audible indication
- Dual Way direction(C.W./C.C.W.) click Type
- Dual scales (N-m & ft-lb.)
- Quick release button
- Adjusting ring locking system
- Aluminum Alloy handle with anodic treatment
- Si-Cr-Mo spring
- Cr-Mo pawl
- Cr-Mo square driver
- 48 Gear teeth

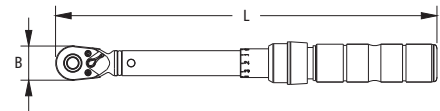

SKU#	DESCRIPTION	Drive Size	Torque Range	Torque Range	Increment	B (mm)	L (mm)	Weight (kg)
STMT73588-8	3/8" Torque Wrench 10-50N-m	3/8"	10-50N-m	9.2-38.7 ft-lb	0.5 N-m	31	409	1.182

## 1/2" Torque Wrench 20-100N-m



- ISO 6789, ASME B107.14
- Accuracy: +/- 4%
- Visual and audible indication
- Dual Way direction(C.W./C.C.W.) click Type
- Dual scales (N-m & ft-lb)
- Quick release button
- Adjusting ring locking system
- Aluminum Alloy handle with anodic treatment
- Si-Cr-Mo spring
- Cr-Mo pawl
- Cr-Mo square driver
- 48 Gear teeth

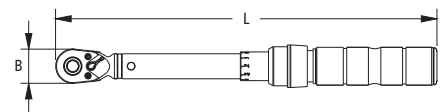

SKU#	DESCRIPTION	Drive Size	Torque Range	Torque Range	Increment	B (mm)	L (mm)	Weight (kg)
STMT73589-8	1/2" Torque Wrench 20-100N-m	1/2"	20-100N-m	16.6-75.6 ft-lb	0.5 N-m	31	409	1.19

1 MEASURING & LAYOUT TOOLS

2 CUTTING & HOLDING TOOLS

3 FASTENING TOOLS

4 STRIKING & STRUCK TOOLS

5 PAINTING & FINISHING TOOLS

6 MECHANIC TOOLS

7 TOOLS STORAGE

## 6 MECHANIC TOOLS

### 1/2" Torque Wrench 40-200N-m



- ISO 6789, ASME B107.14
- Accuracy: +/- 4%
- Visual and audible indication
- Dual Way direction(C.W./C.C.W.) click Type
- Dual scales (N-m & ft-lb)
- Quick release button
- Adjusting ring locking system
- Aluminum Alloy handle with anodic treatment
- Si-Cr-Mo spring
- Cr-Mo pawl
- Cr-Mo square driver
- 48 Gear teeth

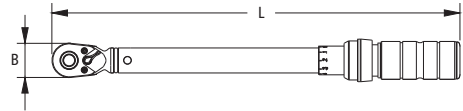

SKU#	DESCRIPTION	Drive Size	Torque Range	Torque Range	Increment	B (mm)	L (mm)	Weight (kg)
STMT73590-8	1/2" Torque Wrench 40-200N-m	1/2"	40-200N-m	33.2-151.2 ft-lb	1 N-m	40	519	1.6

### 1/2" Torque Wrench 60-340N-m

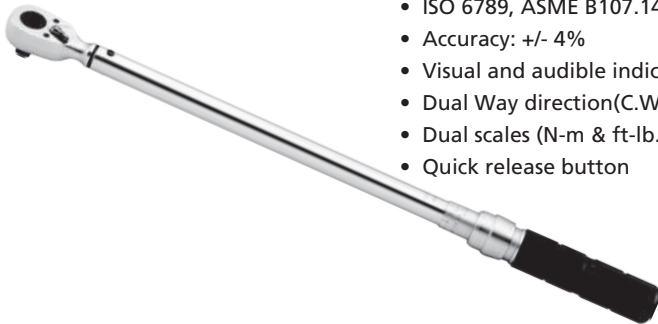

- ISO 6789, ASME B107.14
- Accuracy: +/- 4%
- Visual and audible indication
- Dual Way direction(C.W./C.C.W.) click Type
- Dual scales (N-m & ft-lb.)
- Quick release button
- Adjusting ring locking system
- Aluminum Alloy handle with anodic treatment
- Si-Cr-Mo spring
- Cr-Mo pawl
- Cr-Mo square driver
- 48 Gear teeth

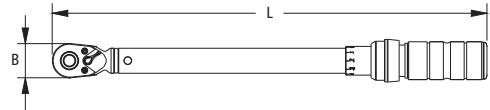

SKU#	DESCRIPTION	Drive Size	Torque Range	Torque Range	Increment	B (mm)	L (mm)	Weight (kg)
STMT73591-8	1/2" Torque Wrench 60-340N-m	1/2"	60-340N-m	51.6-258.1 ft-lb	2 N-m	41	610	1.785

### 3/4" Torque Wrench 150-750N-m



- ISO 6789, ASME B107.14
- Accuracy: +/- 4%
- Visual and audible indication
- Dual Way direction(C.W./C.C.W.) click Type
- Dual scales (N-m & ft-lb)
- Quick release button
- Adjusting ring locking system
- Aluminum Alloy handle with anodic treatment
- Si-Cr-Mo spring
- Cr-Mo pawl
- Cr-Mo square driver
- 48 Gear teeth

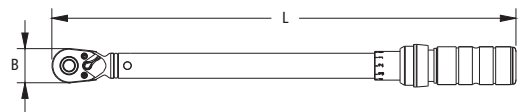

SKU#	DESCRIPTION	Drive Size	Torque Range	Torque Range	Increment	B (mm)	L (mm)	Weight (kg)
STMT73592-8	3/4" Torque Wrench 150-750N-m	3/4"	150-750N-m	110-550 ft-lb	2.5 N-m	58	1112	5.87

# 1/2" Mini Impact Wrench

- High working torque
- Durable and lightweight
- Ergonomic design
- Compact aluminium housing for better access in tight areas

**1/2" DR.**  
**678**  
MAX TORQUE N.m

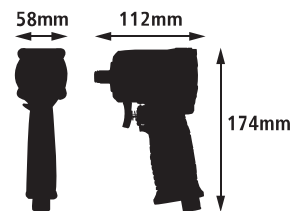

SKU#	DESCRIPTION	Length mm	Weight kg	Hose Size inch	Air Inlet PT	Free Speed rpm	Max Torque N.m	Anvil inch	Average Air Consumption (CFM)
STMT74840-8	1/2" Mini Impact Wrench	112	1.3	3/8"	1/4"	10,000	678	1/2"	5.3

1 MEASURING & LAYOUT TOOLS  
2 CUTTING & HOLDING TOOLS  
3 FASTENING TOOLS  
4 STRIKING & STRUCK TOOLS  
5 PAINTING & FINISHING TOOLS  
6 MECHANIC TOOLS  
7 TOOLS STORAGE

# 7 TOOLS STORAGE

## PROFESSIONAL DESIGN, VERSATILITY & DURABILITY

Quality, innovation and durability – the same principles used to build world-class hand tools is applied to the manufacture of our tools storage products. This comprehensive category is divided into 6 product lines: tool bags, toolboxes, mobile storage devices, organizers and bins, garage workshop cabinets, and collapsible sawhorses. In total, there are more than 80 storage products available, and each one is well-engineered, thoughtfully designed and job-site tough.



### ZAG® MODULAR ROLLING WORKSHOP W/ONE TOUCH LATCH TOOLBOX + DRAWER



- Portable detachable containers with handles on top allows for the customization of storage options and to carry only the options you need.
- Top detachable toolbox with drawer and one hand operation latch, 2 drawer storage unit with shallow & deep drawer and bottom flip bin with back pocket for long tools storage (saw & level) - versatile organization for various sizes of tools and small parts.
- Aluminum telescopic back handle for easy elevation; handle can be lowered for storage.
- Heavy-duty ball bearing slides for the drawers-quality drawer sliding system with better grip and locking mechanism.
- Heavy-duty 7" wheels for easy on-site maneuverability.
- On top 19" toolbox with one hand operation latch allowing to open the box when the other hand is occupied.





“

We understand that transporting the right tools and components quickly and easily to the jobsite is an issue for every pro, so having examined the needs of different trades we've created our Modular Rolling Workshop. The 7" full rubber wheels are designed for tough terrains, it has a large flip bin for power tools, a two drawer organizer unit and a toolbox with a further organizer drawer. Each unit can be easily separated and carried individually, or two can be carried together, connected by the heavy-duty side latches.

”

## 7 TOOLS STORAGE



### Open Mouth Wheeled Tool Bag – 20”

- Made of durable, tough wear and water-resistant plastic wrapped in and virtually maintenance-free 600 denier polyester fabric
- Integrated foam rubber and plastic structure reinforcements create a non-collapsing design
- Elevated fee
- Open mouth design with zipper allows for easy access/secure transport of bag contents
- Heavy-duty metal framework supports open mouth design
- Large handles for comfort and grip with padded over wrap to fasten both handles together
- Telescoping handle extends to a height of 39” for easy tool transport
- Two (2) 1.5” wide casters bracket mounted with heavy-duty metal rivets

SKU#	DESCRIPTION	ITEM SIZE	MAIN STORAGE	BOX/CTN
93-328	Open Mouth Wheeled Tool Bag – 20”	19” x 9” x 12” 50mm x 23mm x 30mm	2,052 inch <sup>3</sup>	1/2



### 16”/19” Professional Tool Box

- One Hand Operation  
Allows opening with one hand occupied
- Shuts Automatically
- Maximum Storage  
Small parts storage on lid

SKU#	DESCRIPTION
STST19410	19” New Stanley Metal Latch



### 3-in-1 Mobile Work Center

- 18 in. toolbox for spacious tool storage
- Removable tray allows enough space for larger tools to be stored underneath
- Large bottom bin for larger hand tools and power tools
- Metal front and side latches for heavy duty usage - side latches can be clicked shut with or without organizer
- Large 7 inch wheels for on site use

SKU#	DESCRIPTION	Item Size
STST18613	3-in-1 Mobile Work Center	24.8” x 18.5” x 11” 629.92mm x 469.9mm x 279.4mm



## Toolbox

- Removable organizer on lid
- Internal tray

SKU#	DESCRIPTION	Length mm	Width mm	Height mm	Weight (kg)	Latch
STST73697-8	15" Toolbox - Flat Top	380	190	142	0.9	Plastic
STST73691-8	17.5" Toolbox - Flat Top	445	241	218	1.8	Plastic
STST73696-8	16" Toolbox - Slide-in Organizer	405	241	152	1.0	Plastic
STST73693-8	17.5" Toolbox - Slide-in Organizer	445	241	220	1.8	Plastic

## 19" Toolbox

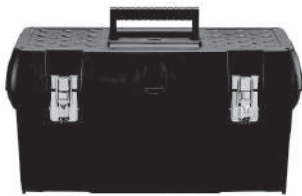

- Built in padlock eye for small locks for secure storage of tools
- Nickel plated metal latches for durability
- Tote tray

SKU#	DESCRIPTION	Item Size
STST19005	19" inch Toolbox	9.9 in x 19.4 in x 9.6 in 251.46 mm x 492.76 mm x 243.84 mm

## 24" Series 2000 Toolbox



- Small top organizers - enable small parts organization
- Geometric lock latches - lock guarantee, enables smooth closing & opening
- Nickel-plated metal latches
- 2/3 tote tray
- Pad lock - for maximum security

SKU#	DESCRIPTION	Item Size
STST24113	24" inch Toolbox	11.2 in x 23.7 in x 11.5 in 284.48 mm x 601.98 mm x 292.1 mm

## 7 TOOLS STORAGE



### STANLEY ESSENTIAL BACKPACK

SKU#	DESCRIPTION	WIDTH	HEIGHT	DEPTH	BOX/CTN
STST1-72335	Essential Backpack	30.5cm	47.5cm	18.5cm	4

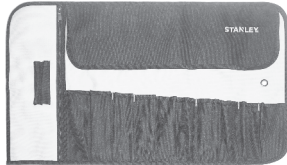

### STANLEY ESSENTIAL TOOL APRON

SKU#	DESCRIPTION	WIDTH	HEIGHT	DEPTH	BOX/CTN
1-93-601	Essential Toolroll	64.5cm	0.5cm	38.5cm	1



### STANLEY ESSENTIAL TOOL APRON

SKU#	DESCRIPTION	WIDTH	HEIGHT	DEPTH	BOX/CTN
1-96-178	Essential Tool Apron	60cm	25.5cm	7.5cm	12



### STANLEY ESSENTIAL 20" OPEN TOTE

SKU#	DESCRIPTION	WIDTH	HEIGHT	DEPTH	BOX/CTN
1-70-319	20" Open Tote	52cm	28cm	26cm	14



### STANLEY 12" OPEN TOOL BAG

- Open tool bag
- Perfect to hold small tools and consumables
- Ergonomic shoulder strap

SKU#	DESCRIPTION	WIDTH	HEIGHT	DEPTH	BOX/CTN
STST 1-70718	12" Open Tote	31cm	20cm	26cm	4





**STANLEY®**



# 志發

CHEE FATT

**W : [www.cheefatt.com](http://www.cheefatt.com)**

**E : [marketing@cheefatt.com](mailto:marketing@cheefatt.com)**

**T : +65 6294 2066**

# STANLEY®

© 2018 Stanley Black & Decker

**Black & Decker Asia Pacific  
(Malaysia) Sdn Bhd** (250839-H)

Unit 16.02, Level 16, 1 First Avenue,  
2A Dataran Bandar Utama,  
Bandar Utama, 47800 Petaling Jaya,  
Selangor Darul Ehsan, Malaysia.

[www.stanleyblackanddecker.com](http://www.stanleyblackanddecker.com)

